

Chem  
7208  
68.3A

[www.libtool.com.cn](http://www.libtool.com.cn)

Lawrence Scientific School.  
ENGINEERING DEPARTMENT.  
No. \_\_\_\_\_

SCIENCE CENTER LIBRARY  
HARVARD COLLEGE  
LIBRARY

[www.libtool.com.cn](http://www.libtool.com.cn)

Hand  
over  
\$ 7.20

[www.libtool.com.cn](http://www.libtool.com.cn)

[www.libtool.com.cn](http://www.libtool.com.cn)

A  
PRACTICAL TREATISE ON  
METALLURGY.



[www.libtool.com.cn](http://www.libtool.com.cn)

LONDON:  
PRINTED BY WILLIAM CROOKES, CHEMICAL NEWS OFFICE,  
BOY COURT, LUDGATE HILL, E.C.

0

A

PRACTICAL TREATISE

[www.libtool.com.cn](http://www.libtool.com.cn)  
ON

METALLURGY,

ADAPTED FROM THE LAST GERMAN EDITION

OF

PROFESSOR KERL'S METALLURGY,

BY

WILLIAM CROOKES, F.R.S., &c.,

AND

ERNST RÖHRIG, Ph.D., M.E.

---

IN TWO VOLUMES—VOL. I.

LEAD, SILVER, ZINC, CADMIUM, TIN, MERCURY, BISMUTH,  
ANTIMONY, NICKEL, ARSENIC, GOLD,  
PLATINUM, SULPHUR.

ILLUSTRATED WITH 207 WOOD ENGRAVINGS.

---

LONDON:  
LONGMANS, GREEN, AND CO.  
1868.

Chem 7208.68.3  
A

[www.libtool.com](http://www.libtool.com)



From Old Engineering  
Library

## P R E F A C E .

---

THE Treatise herewith offered to the English Metallurgist is intended to furnish him with the contemporaneous experience of metallurgical operations, acquired chiefly on the European Continent. For this purpose it has been deemed advisable to adapt the German edition of Kerl's Metallurgy, which, both here and on the Continent, is justly considered a standard work of reference on the subject.

Professor Kerl wrote this treatise partly to serve as a text-book to his lectures on Metallurgy, and this circumstance has constrained us to make some alterations in arrangement and some condensation of substance, so that the present work is confined to two volumes, whilst that of Kerl comprises four. From the great number of analyses in Kerl's book we have given only a judicious selection, and made use of the introductory part so far only as is required for elucidating the various operations; we have, moreover, omitted all reference to Assaying, as the new edition of Mitchell's *Manual of Practical Assaying*, fully treating of this subject, may be considered as adequately representing that branch of Metallurgy.

But our task has not been restricted to condensation and omission. Wherever desirable, we have given processes and details not to be found in Kerl's original treatise.

The present volume contains thirteen chapters, treating of Lead, Silver, Zinc, Cadmium, Tin, Mercury, Bismuth, Antimony, Nickel, Arsenic, Gold, Platinum, and Sulphur, respectively.

In the second volume it is intended to give a chapter on Fuel, and to treat *in extenso* of the two metals Copper and Iron, the most important as regards English Metallurgical industry, and which have contributed most to the fame of English Metallurgists. But there is danger lest this renown, so justly earned, should lead to a complacent security inimical to progress; hence in Metallurgical operations it is indispensable that the Metallurgist should be thoroughly conversant with all improvements wherever made, which, in a compendious form and in the English tongue, has been hitherto inaccessible to him.

Besides the details of a great number of foreign Metallurgical operations, we have not failed to bestow due consideration on the processes carried out in America as well as in England; and we trust that English, as well as American Metallurgists—to whom this Treatise is likewise dedicated—will find this English adaptation of Kerl's great work useful to them.

LONDON, *September*, 1868.

# CONTENTS

OF THE

## FIRST VOLUME.

---

### CHAPTER I.

#### LEAD.

	PAGE.
Principal Ores of Lead . . . . .	I
Galena, 1. White Lead Ore, 4. Sulphate of Lead, 5. Pyromorphite, 5. Yellow Lead Ore, 5.	
Synopsis of Processes for the Extraction of Lead from its Ores . . . . .	6
Influence of Foreign Substances contained in Lead Ores, 6. Importance of the Preparation of the Ore, 7. The chief modes of Extracting Lead from its Ores, 10.	
I. Smelting of Sulphuretted Lead Ores . . . . .	13
Classification of the Processes, 13.	
Decomposition of Galena by Roasting Processes in Reverberatory Furnaces . . . . .	14
Theory of these Processes, 14. Products of these Processes, 22.	
The Carinthian Reverberatory Process . . . . .	24
Illustrations of the Carinthian Process . . . . .	27
Carinthia, 27. Holzappel, 32. Davos, 32. Spain, 33.	
The English Reverberatory Process . . . . .	35
Illustrations of the English Process . . . . .	37
Flintshire, Bristol, Newcastle-upon-Tyne, &c., 37. Spain, 46. Modifications of the normal English Reverberatory Process, 50.	
The French Reverberatory Process . . . . .	54
Illustrations of the French Process . . . . .	55
Poullaouen, 55. Pesey, 59. Corphali, 59. Bleiberg and Binsfeldhammer, near Stolberg, 60. Lead Works near the mouth of the Rhone, 64. Bottino, 64.	

The French Precipitation or Vienne Process (Decomposition of Galena in Reverberatory Furnaces by means of Iron) . . . . .	65
Illustrations of the French Precipitation Process . . . . .	67
Vienne, 67. Lead Works on the Rhone, 67. St. Louis, 67. Escallette, 68.	
Extraction of Lead in Hearth Furnaces . . . . .	68
The Scotch Hearth Process . . . . .	69
Cumberland, Northumberland, Durham, Alston Moor, 69. Pesey, 72.	
The American Hearth Process . . . . .	72
The Backwood Hearth, 73.	
Illustrations of the American Hearth Process . . . . .	74
Rosie in the United States, 74. Bleiberg, 74.	
The Cupola Furnace Process . . . . .	75
Cupola Furnaces, 76.	
Decomposition of Raw Ores in Cupola Furnaces by means of Iron (Precipitation Process) . . . . .	82
The Advantages and Disadvantages of the Process, 82 and 83. Influences upon the Success of the Process, 83. The Nature of the Ore, 83. The Mixture of the Ores, 86. The Construction of the Cupola Furnaces, 90. Fuel, 92. The Smelting Process, 93. The Products of the Process, 96.	
Illustrations of the Precipitation Process . . . . .	98
Upper Hartz, 98. Victor-Friedrichshütte, 108. Tarnowitz, 109. Przibram, 110. Joachimsthal, 112. Kinzigthal, 113. Ems, 113. Sala, 113. Banat, 113.	
Treatment of Roasted Ores with Iron, or some Ferruginous Flux (Roasting Reduction Precipitation Process) . . . . .	113
The Roasting of the Ores . . . . .	114
Methods of Roasting, 114. Influence of Foreign Substances, 116.	
Smelting the Roasted Ores . . . . .	117
Smelting Process, 117. Composition of the Mixture, 117. Smelting Furnaces, 119. Smelting Products, 120.	
Illustrations of Smelting Ores Poor in Lead, and associated with Pyrites and Blende . . . . .	121
Lower Hartz, 121. Fahlun, 125.	
Illustrations of Working Ores Rich in Lead, and associated with Foreign Sulphides and Earths . . . . .	125
Przibram, 125. Freiberg, 127. Lower Hungary, 142. Holzappel, 144. Lohe, Müsen, and Rothenbach, 145. Pontgibaud, 150. Vialas, 153. Lead works on the Rhone, 154. Bottino, 155. Spain, 155.	

Illustrations of the Processes for Working Rich Lead Ores, containing Earthy Matter, but little Foreign Sulphides . . . . .	156
Bleiberg, 156. Mühlgasse Smelting works, 156. Münsterbusch, 158. Ramsbeck, 159. Ems, 159.	
2. Treatment of Oxidised Ores and Products . . . . .	161
Oxidised Ores . . . . .	161
Reduction of White Lead Ore in Reverberatory Furnaces . . . . .	161
Treatment of White Lead Ore in Cupola Furnaces . . . . .	162
Illustrations of the Cupola Furnace Process for Reducing White Lead Ores . . . . .	163
Altai Smelting Works, 163. Münsterbusch, 164. Spain, 165.	
Reduction of Sulphate of Lead . . . . .	168
Treatment of Oxidised Smelting Products . . . . .	171
Reduction of Litharge . . . . .	171
Reduction of Litharge in Reverberatory Furnaces . . . . .	172
Illustrations of the Litharge Reduction Process . . . . .	172
England, 172. Holzappel, 175. Poullaouen, 175.	
Reduction of Litharge in Cupola Furnaces . . . . .	176
Illustrations of the Reduction of Litharge in Cupola Furnaces . . . . .	177
Upper Hartz, 177. Lower Hartz, 178. Freiberg, 178. Przibram, 179. Tarnowitz, 180.	
Reduction of Litharge in Hearth Furnaces . . . . .	180
Illustrations of the Reduction of Litharge in Hearth Furnaces . . . . .	181
Barnaul in Siberia, 181. Fernezely in Hungary, 181. Bottino, 181.	
Reduction of Litharge in Scotch Furnaces . . . . .	182
Pezey and Pontgibaud, 182.	
Reduction of the Dross . . . . .	182
Illustrations of the Processes for the Reduction of Dross . . . . .	183
Upper Hartz, 183. Lower Hartz, 184. Przibram, 185. Holzappel, 185. Müsen, 185. Ems, 186.	
Treatment of the Bottoms of Furnaces . . . . .	186
Reduction of Lead Slags . . . . .	186
Illustrations of the Processes for the Reduction of Lead Slags . . . . .	187
Freiberg, 187. Tarnowitz, 187. Hettstädt, 187. Sardinia, 187. Spain, 188.	



3. Purification of the Lead . . . . .	188
Foreign Substances contained in Lead, 188. Signs of the Purity of Lead, 189. Theory of the Processes for the Purification of Lead, 189.	
The Modes of Purification . . . . .	190
Skimming the Lead, 190. The Liquefaction Process, 191. Stirring the melted Lead with a Birch Pole, 191. Pattinson's Process, 192. Oxidation Smelting in Air Reverberatory Furnaces, 192. Oxidation Smelting in Blast Reverberatory Furnaces, 196. Baker's Method of Calcining Lead, 199. Pontifex and Glassford's Method of Calcination, 199.	
The Annual Production of Lead . . . . .	200

## CHAPTER II.

## SILVER.

Principal Ores of Silver . . . . .	201
Real Silver Ores, 201. Argentiferous Lead, Copper, Zinc, &c. Ores, 204. Dressing the Silver Ores, 205.	
Synopsis of Processes for the Extraction of Silver from its Ores . . . . .	206
Extraction of Silver in the Dry Way by means of Lead, 206. Extraction of Silver in the Wet Way by Amalgamation, 210. Mr. Crookes's Process of Extraction by means of Sodium Amalgam, 211. Lixiviation and Precipitation of Silver in the Metallic State, 211. Patara's Process, 211. Treatment of Argentiferous Raw Copper with Sulphuric Acid, 212. Classification of the Processes, 212.	
Treatment of Argentiferous Ores and Products in the Dry Way, by means of Lead . . . . .	213
The Reactions of Lead, 214. Reaction of Oxide and Sulphate of Lead, 215.	
Production of Argentiferous Lead (Raw Lead) . . . . .	216
Treatment of rich Silver Ores . . . . .	216
Smelting of rich Ores in Crucibles . . . . .	216
Former mode at Kongsberg, 217	
Refining Native Silver . . . . .	217
Fusing rich Silver Ores with Raw Lead in the Cupelling Process . . . . .	218
Theory of the Process, 218. Andreasberg, 218. Poullaouen, 218. Freiberg, 219.	
Smelting rich and moderately rich Silver Ores with Lead Compounds . . . . .	219
Illustrations of the Processes of Smelting rich Silver Ores . . . . .	219
Andreasberg, 219. Hungary, 220. Allemont, 220. Freiberg, 220.	

Treatment of Argentiferous Lead Ores . . . .	221
Treatment of Argentiferous Copper Ores . . . .	221
Illustrations of the Processes for the Reduction of Argentiferous Copper Ores . . . .	221
Lohe and Müsen, 221. Freiberg, 221.	
Raw Smelting of poor Dürr Ores . . . .	222
Theory of the Process, 222. The Formation of a suitable Mix- ture, 222. The Raw Smelting Process, 226.	
Illustrations of the Raw Smelting Process in Cupola Furnaces . . . .	228
Kongsberg, 228. Lend, 229. Hungary, 230.	
Lead Process with Argentiferous Matts . . . .	233
Smelting Methods, 233.	
Desilverising the Matt by means of Metallic Lead . . . .	233
Theory of the Process, 233. Applicability of the Process, 233.	
Illustrations of Desilverising Matt by fusion with Lead . . . .	234
Altai, 234. Kongsberg, 234.	
Desilverising the Matt by means of Lead Ores and Products . . . .	237
Illustrations of the Process . . . .	237
Hungary, 237. Lend, 238. Freiberg, 239.	
Desilverising Matt by Lead Products and Copper . . . .	245
Theory of the Process, 245. Smelting with Black Copper, 246. Abdarr Process, 246.	
Lead Process with Argentiferous Speiss . . . .	246
Different Modifications of the Process, 246.	
Lead Process with Argentiferous Black Copper . . . .	247
Cupellation of Black Copper, 247. Liqueation of Black Copper, 247.	
Manipulations of the Liqueation Process . . . .	248
Reducing the Black Copper into small fragments, 248. Alloying the Black Copper with Lead, 249. The Liqueation Process, 250. The Process of Sweating, 251.	
Extraction of Silver from Raw Lead . . . .	251
Cupelling Process, 251. Pattinson's Process, 252. Parkes's Pro- cess, 253.	
Pattinson's Process . . . .	253
Theory of the Process, 253. Systems of Crystallisation, 253. Circumstances which influence the Process, 257. Comparison between Cupellation and Pattinson's Process, 258. Products of Pattinson's Process, 259.	
Apparatus for Pattinson's Process . . . .	261
Pattinson's Pans, 261. Furnaces for reducing the Dross from the Pans, 263.	

High (Thirds) System of Crystallisation . . . . .	264
Manipulations, 264. Table explaining the operations of Pattinson's Process, 266.	
Illustrations of the High System of Working without Intermediate Crystals . . . . .	267
Upper Hartz, 267. Münsterbusch, 261. Tarnowitz, 269. England, 270.	
Illustrations of the High System of Working with Intermediate Crystals . . . . .	271
England, 271. Freiberg, 271.	
Low System of Crystallisation . . . . .	273
Manipulations, 273.	
Illustrations of the Low System of Crystallisation . . . . .	274
Binsfeldhammer, 273. Bleiberg, 274. Commern, 274.	
Cupelling the Raw Lead . . . . .	274
Theory, 274. Methods of Cupellation, 275.	
The German System of Cupellation . . . . .	275
The Process and its Modifications, 275. Cupelling Furnaces, 276.	
Manipulations of the Cupelling Process . . . . .	278
The Formation of the Hearth, 278. The Charging of the Raw Lead, 279. Melting the Lead, 279. The Formation of Litharge, 280. The period of Brightening, 284. The Loss of Metal in the Process, 286.	
Illustrations of the German Cupelling Process . . . . .	287
(Cupelling without After-charge with Wood), Upper Hartz, 287. Lower Hartz, 288. Przi Bram, 288. Ems, 289. Pontgibaud, 289. Kongsberg, 290. (Cupelling without After-charge with Coal), Tarnowitz, 290. Vialas, 291. (Cupelling with After-charge with Wood), Freiberg, 292. Kremnitz, 293. Altai, 293. (Cupelling with After-charge with Coal), Siegen, 293. Holzappel, 294. (Cupelling with Concentration of the Raw Lead), Tarnowitz, 295.	
The English System of Cupellation . . . . .	295
The Process, 295. Cupelling Furnaces, 296. Manipulations in Cupelling, 299.	
Illustrations of the English Cupelling Process . . . . .	300
Lead Works in England, 300. Stolberg, 301.	
Refining the Brightened Silver . . . . .	302
The Process, 302. Methods of Refining, 302. Products of the Process, 303.	
Refining in Cupelling Furnaces . . . . .	304
Lohe, 304.	
Refining by the aid of Blast . . . . .	305
Refining in the Muffle . . . . .	305
Oker, 306. Clausthal, 306. Victor Friedrichshütte, 307.	

Refining in Reverberatory Furnaces . . . . .	307
The Process and its Advantages, 307.	
Refining in Reverberatory Furnaces with Movable Hearth or Test . . . . .	308
Tarnowitz, 308. England, 309. Poullaouen, 309. Kongsberg, 310.	
Refining in Furnaces with Fixed Hearth . . . . .	310
Przibram, 311. Freiberg, 312. Mansfeld, 313.	
Refining in Crucibles . . . . .	314
Pontgibaud, 314. Vialas, 315. Arany-Idka, 315.	
The Extraction of Silver from Rich Lead by means of Zinc . . . . .	315
(Parkes's Process). Theory of the Process, 315. Llanelly, 316. Tarnowitz, 317.	
Extraction of Silver in the Wet Way . . . . .	317
Theory, 317.	
Extraction of Silver by means of Mercury (Amalgama- tion) . . . . .	317
Theory, 317. Methods of Amalgamation, 318.	
European Process of Amalgamation in Casks . . . . .	319
Its Advantages and Disadvantages, 319.	
Amalgamation of Silver Ores . . . . .	319
Nature of the Ores required for Amalgamation, 319.	
Manipulations of the Amalgamation Process . . . . .	320
Pounding the Ore, 320. Mixing the Ore, 320. Roasting the Ore, 320. The Amalgamation, 321. Treatment of the Resi- dues, 326. Treatment and Distillation of the Amalgam, 327. Arany-Idka, 330. Huëlgoet, 331. Spain, 331. Mexico, 331.	
Amalgamation of Argentiferous Matt . . . . .	331
Amalgamation of Speiss . . . . .	332
Amalgamation of Black Copper . . . . .	333
The American System of Amalgamation in Heaps . . . . .	335
Advantages of this System, 335. Theory, 338. The Process as carried on in Mexico and Bolivia, 342.	
Mr. Crookes's Process of Extraction by means of Sodium Amalgam . . . . .	347
Advantages of the Process, 347. Preparation of the Amalgams, 349. Using the Amalgam, 350.	
Illustrations of the Sodium Amalgamation Process . . . . .	352
Reports on Mr. Crookes's Process, 353.	
Treatment of Silver Ores and Argentiferous Products in the Wet Way (by Solution and Precipitation) . . . . .	364
Different Methods, 364.	

Augustin's Process of Extracting Silver with Salt Water . . . . .	364
Theory of the Process, 364. Comparison with the Amalgamation, 365. Substances best adapted for the Process, 366. Treating the Substances, 366.	
Augustin's Process for the Treatment of Copper Matt Manipulations, 368. Freiberg, 370.	368
Augustin's Process for the Treatment of Speiss . . . . .	375
Augustin's Process for the Treatment of Black Copper	376
Ziervogel's Method of Extracting Silver with Hot Water . . . . .	378
Theory of the Process, 372. Comparison with Augustin's Process, 379. Operations, 380.	
Extraction of Silver by Means of Hyposulphites . . . . .	391
Different Methods, 391. Patera's Method, as carried on at Joachimsthal, 393.	
Extraction of Silver with Sulphuric Acid . . . . .	395
The Process, 395. Comparison with the Liqutation Process, 396. Freiberg, 397. Lower Hartz, 399.	

## CHAPTER III.

## ZINC.

Principal Ores of Zinc. . . . .	402
Calamine, 402. Hydrated Carbonate of Zinc, 403. Red Zinc Ore, 404. Zinc Blende, 404. The Zinc Ores of England, 404.	
Synopsis of Processes for the Extraction of Zinc from its Ores . . . . .	405
Theory of the Process, 405. Improvements, 408. Manipulations, 409.	
i. Preparation of Zinc Ores . . . . .	409
a. Calcining and Roasting Zinc Ores . . . . .	409
Calcining in Cupola Furnaces, 410. Altenberg, 410. Spain, 410. Calcination in Reverberatory Furnaces, 411. The Roasting of Zinc Blende, 412. Behaviour of Blende in Roasting, 412. Borbeck, 415. Llansamlet, 415. Crockford's Method, 416. Moriston, 416. Przibram, 417.	
b. Dividing the Calcined or Roasted Ores . . . . .	420
c. Mixing the Zinc Ores . . . . .	421

2. Distillation of Zinc . . . . .	422
Theory, 422. Different Modes of Distilling Zinc, 423. Circumstances modifying the Different Methods:—The Price and Quality of Coal, 424. The Price and Quality of the Clay, 425. The Amount of Zinc in the Ores, 426. The Influence of Foreign Substances in the Ore, 426. The Extension of the Production, 427. The Cost of Furnaces, 427. The Skill of the Workmen, 427.	
The Belgian Method of Extracting Zinc . . . . .	428
Utility of the Method, 428. Furnaces, 428. Manufacture of the Retorts, 429. Construction of the Furnaces, 431. Manipulations of the Distillation of Zinc, 432.	
Illustrations of the Belgian Process . . . . .	434
a. Treatment of Calamine . . . . .	434
Moresnet, 434, Angleur and St. Leonhard, 435.	
b. Treatment of Blende . . . . .	435
Corphalie, 435.	
The Silesian Process . . . . .	436
Utility of the Process, 436. Different Systems of the Process, 436.	
Silesian System . . . . .	436
Furnaces, 436. Number of Muffles, 437. Manufacture of Muffles, 438. Manufacture of the Adapters, 440. Furnace at Llansamlet for burning Muffles, 439. Construction of the Muffle Furnaces, 441	
Illustrations of the Process for the Treatment of Calamine . . . . .	442
Upper Silesia, 442. Steinfurth near Stolberg, 445.	
Illustrations of the Process for the Treatment of Blende . . . . .	446
Heinrichshütte near Stolberg, 446. Friedrich Wilhelmshütte near Stolberg, 446. Llansamlet, 447.	
Belgian-Silesian System of Extracting Zinc . . . . .	448
Peculiarity of the Furnaces, 448. Number of Muffles, 448. Adapters, 449. Construction of the Furnaces, 450. Furnaces with two rows of Muffles one above the other, 452.	
The Distillation of Zinc . . . . .	453
Illustrations of the Belgian-Silesian System . . . . .	454
Valentin Cocq and Flone in Belgium, 454. Berge-Borbeck, 454.	
The Old English Process for Reducing Zinc . . . . .	455
The Process and its Disadvantages, 455. Furnaces, 455. Production, Importation and Exportation of Zinc in England, 457.	
Extraction of Zinc in Cupola and Reverberatory Furnaces . . . . .	457
Disadvantages of these Processes, 457.	

Illustrations of these Processes . . . . .	458
Upper Hartz, 458. Broomann's Method, 458. Rochaz, 459. E. Dyar, 459. F. Darlington, 459. A. Accarin, 459. H. Müller and Lencauchez, 460.	
Treatment of the Products of the Reducing Processes	460
a. Re-melting and Refining the Raw Zinc . . . . .	460
Products and By-products, 460. Re-melting in Crucibles, 460. Refining in Reverberatory Furnaces, 462. Impurities of Zinc and their Influences, 463. Influence of the Temperature at which the Zinc is cast, 465.	
Reduction of Zinc Dust . . . . .	465
Composition of Zinc Dust, 465. Reduction in Distillation Vessels, 466. Montefiore's Furnace, 466.	
Working the Residues and Deposits . . . . .	466
The Annual Production of Zinc in Europe . . . . .	467

## CHAPTER IV.

## CADMIUM.

Ores . . . . .	468
Calamine, 468. Blende, 468. Cadmia Fornacum, 468.	
Production of Cadmium . . . . .	469
Processes, 469.	
Illustration of the Production of Cadmium . . . . .	469
Upper Silesia, 469.	
Uses of Cadmium . . . . .	470

## CHAPTER V.

## TIN.

Principal Tin Ores . . . . .	471
Tin Stone (Cassiterite), 471. Wood Tin, 471. Stannine, 471. Cornish Ores, 472.	
Synopsis of Processes for the Extraction of Tin from its Ores . . . . .	473
Certain Properties of the Oxide of Tin, 474. The Quality and Quantity of the Earthy Associates, 474. The Quality of the Metallic Associates, 475.	
Preparation of Tin Ores . . . . .	475
Mechanical and Chemical Treatment, 475.	
Soft-burning of the Ore previous to its Dressing . . . . .	475
Altenberg in Saxony, 475.	
Mechanical Dressing of Tin Ores . . . . .	476
Dressing Operations, 476. Comparison of Mining and Dressing of Tin Ores, 476.	

Roasting the Concentrated Tin Schlich . . . . .	476
Object of the Roasting, 476. Process, 477. Furnaces with one Hearth, 478. Brunton's Patent Calciner, 479.	
Washing the Roasted Schlich . . . . .	482
Treatment of the Purified Tin Schlich with Acids . . . . .	483
Method in Saxony, 483. Mitchell's Method, 483. Method in Corn- wall, 483.	
Purification of Tin Ores from Wolfram . . . . .	484
Influence of Wolfram, 484. Oxland's Smelting Method, 484. Method at Zinnwald, 485. Method at Schlaggenwald, 485.	
Smelting Tin Ores . . . . .	486
Smelting in Cupola or in Reverberatory Furnaces, 486. Smelting Products, 486. Crude Tin, 486. Tin Ore Slags, 489. Deposits, 490. Furnace Ends, 490. Ore Dust, 490.	
Reduction of Tin Ores in Cupola Furnaces . . . . .	490
Applicability of this Process, 490. Ore Mixture, 490. Fur- naces, 491.	
Illustrations of the Process of Reduction in Cupola Furnaces . . . . .	491
Altenberg in Saxony, 491. Annual Production of Tin in Saxony and Bohemia, 495. Re-melting of the Slags, 496. Schlaggenwald in Bohemia, 497. Bretagne (France), 498.	
Reduction of Tin Ores in Reverberatory Furnaces . . . . .	492
Truro in Cornwall, 499.	
Annual Production of Tin in different Countries . . . . .	503

## CHAPTER VI.

## MERCURY.

Principal Ores of Mercury . . . . .	504
Cinnabar, 504. Native Mercury, 504. Mercurial Fallow Ores, 504. Dressing of Mercury Ores, 504.	
Synopsis of Processes for the Extraction of Mercury from its Ores . . . . .	505
Chemical Reactions, 505. Distilling Apparatus, 505. Con- densers, 505. Classification of the Processes, 506. Products of the Processes, 506,	
Extraction of Mercury by Roasting Ores containing Sulphide of Mercury . . . . .	507
Advantages and Difficulties of this Method, 507. Condensers, 507. Construction of Furnaces, 508.	
Illustrations of the Process of Extracting Mercury in Mounds . . . . .	509
Hungary, 509.	



Illustrations of the Extraction of Mercury in Cupola Furnaces with interrupted operations . . . . .	511
Old Process in Idria, 511. Process at Almaden, 514. California, 517.	
Illustrations of the Extraction of Mercury in Cupola Furnaces with continuous operations . . . . .	518
New Process in Idria, 518. Tuscany, 520. Vallata in Venetia, 521. California, 521.	
Illustrations of the Extraction of Mercury in Reverberatory Furnaces with continuous operations. . . . .	521
Idria, 521.	
Extraction of Mercury by the Decomposition of Cinnabar by Fluxes in Closed Vessels . . . . .	524
Modifications of the Process, 525, Comparison between Furnaces with interrupted operations, and Ure's Furnace, 525.	
Illustrations of the Process of Extracting Mercury in Furnaces with interrupted operations . . . . .	525
Older Method in the Palatinate, 525. Horzowith in Bohemia, 527. Zalathna in Transylvania, 527.	
Illustrations of the Extraction of Mercury in Furnaces with continuous operations . . . . .	528
New Method in the Palatinate, 528. New Almaden and New Idria in California, 530	
Production of Mercury throughout the World . . . . .	531

## CHAPTER VII.

## BISMUTH.

Principal Ores of Bismuth . . . . .	532
Native Bismuth, 532. Bismuth Glance, 532.	
Synopsis of Processes for the Extraction of Bismuth from its Ores . . . . .	532
The Liqutation Process . . . . .	532
Products of the Process, 533.	
Extraction of Bismuth by Smelting in Crucibles . . . . .	535
Illustrations of the Liqutation Process . . . . .	536
Liqutation in Open Heaps, 536. Liqutation on Hearths, 536. Liqutation in Iron Tubes, 536. Schneeberg in Saxony, 537.	
Illustrations of the Extraction of Bismuth in Crucibles . . . . .	538
Joachimsthal, 538.	

## CHAPTER VIII.

## ANTIMONY.

Principal Ores of Antimony . . . . .	540
Grey Antimony Ore, 540. Berthierite, 540. Senarmontite, 540. Red Antimony, 540.	

Synopsis of Processes for the Extraction of Crude Antimony and Regulus of Antimony from their Ores	54I
Production of Crude Antimony . . . . .	54I
Theory, 541. Associates of Crude Antimony, 541. Moles of Liquation, 542.	
Liquation of Crude Antimony in Reverberatory Furnaces	542
Ramée, 542.	
Liquation of Crude Antimony in Crucibles . . . . .	543
Liquation in Crucibles in an Open Fire . . . . .	543
Wolfsberg, 543. Malbosc, 543. Magurka, 544.	
Liquation in Vessels standing in Closed Furnaces . . . . .	544
Furnaces necessitating Interrupted Operations, 544. Lincouln, 545. Furnaces with Continuous Operations, 545. Malbosc (France), 546.	
Production of Regulus of Antimony . . . . .	546
Theory, 546.	
Production of Regulus of Antimony from Crude Antimony . . . . .	547
Roasting Reduction Process, 547. Hungary, 547. Oxidation by means of Saltpetre and Reduction, 548. Smelting with Iron and Fluxes, 548. Methods of Berthier, Liebig and Bensch, Karsten, 549. Magurka, 549.	
Production of Regulus of Antimony direct from Ores	549
Smelting Ores in Crucibles . . . . .	550
Rotherhithe, 550.	
Smelting the Ores in Reverberatory Furnaces . . . . .	550
Septèmes and Bouc, 550.	
Smelting the Ores in Cupola Furnaces . . . . .	55I
Septèmes and Bouc, 551.	
Purification of Raw Antimony . . . . .	552
Theory, 552. Rotherhithe, 552. Septèmes and Bouc, 553. Methods of Wöhler, Meyer, Schiel, Berzelius, and Muspratt, 553.	

## CHAPTER IX.

## NICKEL.

Principal Ores of Nickel . . . . .	554
Kupfer-Nickel, 554. Chloantite, 554. Nickel Speiss Glance, 554. Nickel Glance, 554. Antimonial Nickel Glance, 554. Nickel Ochre, 554. Ores of Nickel in Great Britain, 555. Nickeliferous Smelting Products, 556.	
Synopsis of Processes for the Production of Nickel . . . . .	556
Concentration Smelting of Nickel Ores . . . . .	556

Concentration Smelting of Nickel Ores for the Production of Matt . . . . .	556
Theory, 556. Process, 557.	
Illustrations of the Concentration Smelting for the Production of Matt . . . . .	558
Dillenburg, 558. Gladenbach, 560. Klefva, 560. Varallo in Piedmont, 560.	
Concentration Smelting for the Production of Speiss .	561
Theory, 561. Raw Materials, 561.	
Illustrations of the Smelting of Arsenical Nickel Ores for the Production of Speiss . . . . .	562
Sangershausen, 562. Schladming, 562. Birmingham, 562. Camdorf, 563	
Illustrations of the Concentration of Speiss produced by the Copper and Lead Smelting Processes . . .	563
Freiberg, 563. Lower Hartz, 563.	
Illustrations of the Smelting of Intermediate Products (Matt, Slag) free from Arsenic, for the Production of Nickel Speiss . . . . .	564
Altenau, 564. Joachimsthal, 566.	
Concentration Smelting for the Production of Black Copper, or Nickel Deposits . . . . .	566
Mica Copper, 566. Chenot's Mode, 567.	
Production of Metallic Nickel, or of Copper-Nickel Alloys . . . . .	567
Theory of the Process, 567. Nature of Nickel, 567. Marketable Nickel, 567. Analyses of Commercial Nickel, 569. Value of Nickel, 569.	
Production of Nickel in the Dry Way . . . . .	569
Oldest Methods, 569. Rose's Method, 570. Dillenburg, 570.	
Production of Nickel in the Wet Way . . . . .	570
Roasting, 570. Matt Roasting, 571. Speiss Roasting, 571. Reagents employed to Extract Nickel in the Wet Way, 572.	
Illustrations of the Process of Extracting Nickel from Speiss or Arsenical Ores . . . . .	576
Erdmann's Older Method, 576. Louyet's Method, 576. Methods of Ruolz, Thomson, and Cloëz, 577, 578. More recent Method at Joachimsthal, 578. Treatment of Cobalt Ores at Modum, 578.	
Illustrations of the Processes for the Production of Nickel from Matt . . . . .	579
Staph's Method at Klefva, 579. Dillenburg, 580.	

Illustrations of the Processes for the Extraction of Nickel from Refined Copper and Impure Nickel . . . . .	582
Gottesbelohnungshütte (Mansfeld), 582. Ruolz's Method of Purifying Nickel, 583. Deville's Method, 583.	

## CHAPTER X.

## ARSENIC.

Principal Ores of Arsenic . . . . .	584
Native Arsenic, 584. Mispickel, 585.	
Synopsis of Processes for the Extraction of Arsenic from its Ores, and for the Production of its chief Chemical Combinations . . . . .	585
Theory of the Processes, 585.	
Production of Metallic Arsenic . . . . .	585
Allotropic Modifications of Arsenic, 585. Materials, 586. Furnaces, 587.	
Illustrations of the Production of Metallic Arsenic . . . . .	588
Reichenstein, 588. Ribas, 589. Altenberg, 589.	
Production of Arsenious Acid (White Arsenic, Arsenic Glass) . . . . .	590
Principal Operations—Production of Pulverulent Arsenious Acid by Roasting Arsenical Substances, 590. Refining of the Giftmehl for the Production of Arsenic Glass, 593. Products, 595.	
Illustrations of the Production of Arsenious Acid in Muffle Furnaces . . . . .	596
Altenberg in Saxony, 596. Reichenstein, 596. Andreasberg in the Hartz, 598.	
Illustrations of the Production of Arsenious Acid in Reverberatory Furnaces with Direct Firing . . . . .	599
Ribas in Spain, 600.	
Illustrations of the Production of Arsenious Acid in Gas Reverberatory Furnaces . . . . .	600
Freiberg, 600. Ribas, 601.	
Production of Coloured Arsenic Glass (Realgar and Orpiment) . . . . .	602
Realgar, 602. Orpiment, 604.	
Illustrations of the Production of Realgar . . . . .	605
Production of Realgar from Iron and Arsenical Pyrites Saxony, 605. Ribas, 606.	605
Production of Realgar from Arsenical Pyrites and Sulphur . . . . .	607
Reichenstein, 607.	

Production of Realgar from Arsenious Acid and Sulphur Andreasberg, 607.	607
Production of Realgar from Metallic Arsenic and Sulphur . . . . .	607
Reichenstein, 607.	
Illustration of the Production of Orpiment . . . .	607
Reichenstein, 607.	

## CHAPTER XI.

## GOLD.

Principal Ores of Gold . . . . .	609
Native Gold, 609. Tellurides of Gold, 610. The Californian Gold Mines, 611. Australian Gold Mines, 615.	
Synopsis of Processes for the Extraction of Gold from its Ores . . . . .	616
Processes, Mechanical, Chemical, and combinations of both kinds, 617.	
Production of Argentiferous Gold . . . . .	622
Extraction of Gold from Gold Sand . . . . .	622
Amounts of Gold in Sand, 622.	
Extraction of Gold by Washing Gold Sand . . . . .	623
Modes of Washing, 623. Places where Gold is Washed, 624.	
Extraction of Gold by Washing and Amalgamating Gold Sand . . . . .	624
Manipulations, 624.	
Extraction of Gold by Smelting the Gold Sand . . . .	625
Siberian Experiments, 625.	
Extraction of Gold from Earthy Minerals . . . . .	625
Crushing and Washing the Ores, 625. Washing and Amalga- mating, 625.	
Illustrations of the Extraction of Gold from Auriferous Quartz . . . . .	626
Mexico, 626. California and Australia, 626. Brazil, 627. Tran- sylvania, 627. Tyrol, 627.	
Smelting Poor Earthy Gold and Silver Ores with Iron Pyrites, and Treating the resulting Matt with Lead . . .	627
Offenbanya, 628. Szalathna, 628. Longmaid's Method, 628.	
Extraction of Gold from Sulphuretted Ores . . . . .	628
Different Methods, 628. Loss of Gold by Roasting Gold Ores, 629.	
Extraction of Gold by Washing Weathered Pyrites . .	630
Marmato, 630.	

Extraction of Gold from Sulphuretted Ores by Washing and Amalgamating . . . . .	630
Mill Gold, 630. Modifications, 631. Amalgamating Mills, 631.	
Illustrations of the Process of Washing and Amalgamating Sulphuretted Ores . . . . .	632
Schemnitz, 632. Zell in the Tyrol, 635.	
Extraction of Gold from Auriferous Copper, Silver, and Lead Ores by Fusion with Lead . . . . .	635
Processes, 635.	
Extraction of Gold from Sulphuretted Ores and Smelting Products, &c., by Solution and Precipitation . . . . .	636
Plattner's Method, 636.	
Illustrations of Plattner's Process . . . . .	638
Reichenstein, 638. Schemnitz, 643.	
Calvert's Method of treating Auriferous quartz . . . . .	645
Chlorination of Auriferous and Argentiferous Substances, and Extraction of Gold and Silver at the same time . . . . .	645
Theory, 645. Kiss's Method, 646. Patera's Method, 647. Rösszner's Method, 647.	
Lixivation with Sulphuric Acid . . . . .	647
Process, 647. Löwe's Method for Treating Tellurides of Gold, 648.	
Separating (Parting) Gold from Silver . . . . .	648
Purification of the Alloy from Base Metals, 648.	
Parting of Gold from Silver in the Dry Way . . . . .	649
Parting of Gold by Grey Antimony Ore . . . . .	649
Theory, 649. Process, 649.	
Parting of Gold by means of Litharge and Sulphur . . . . .	649
Oker, 649. Kremnitz, 649.	
Extraction of Gold by Cementation . . . . .	650
Manipulation, 650. Boussignault's Investigations, 650.	
Parting of Gold from Silver in the Wet Way . . . . .	651
Advantages of the Wet Way, 651.	
Parting of Gold by means of Nitric Acid (quartation) . . . . .	651
Theory, 651. Manipulations, 651.	
Parting of Gold by means of Sulphuric Acid . . . . .	653
Theory, 653. St. Petersburg, 653. Vienna, 653. Purification of the Alloy from the Base Metals, 654. Mascazzini's Mode of Purification, 655. Manipulations of the Parting Process, 655. Products of the Process, 656. Gold, 656.	

Extraction of Iron, Tin, Antimony, Arsenic, and Lead United States, 658.	658
Pettenkofer's Process for the Separation of Platinum from Gold . . . . .	658
Gold Grains in the Slag, 659.	
Separation of Osm-iridium from Gold . . . . .	660
Philadelphia, 660. New York, 660. Bogolowk, 661. d'Hennin's Mode, 661. Sulphate of Silver, Sulphurous Acid, 661. Extrac- tion of Silver from Sulphate of Silver, 662.	
Parting of Gold in Platinum Vessels . . . . .	664
Precautions Required, 664. Munich, 665. St. Petersburg, 666.	
Parting of Gold in Porcelain Vessels . . . . .	666
Oker, 665.	
Parting of Gold in Cast-iron Vessels . . . . .	669
Behaviour of Cast-iron, 669. Vienna, 670. Frankfort, 671. Krem- nitz, 671. Augsburg, 672.	
Extraction of Gold by means of Aqua Regia . . . . .	672
Theory, 672. Manipulation, 672. Agents for Precipitation, 672.	
Separation of Gold from Copper . . . . .	674
Fusion with Lead, 674. Treatment with Sulphuric Acid, 675. Treatment with Chlorine according to Plattner's Method, 675.	
Treatment of Auriferous and Argentiferous Black Copper by means of Boiling Concentrated Sulphuric Acid . . . . .	675
Septèmes, 675.	

## CHAPTER XII.

## PLATINUM.

Principal Ores of Platinum . . . . .	678
Native Platinum, 678. The Chief Districts in which Platinum occurs, 679.	
Processes for the Extraction of Platinum from its Ores	681
Dressing of the Platinum Sand, 681. Composition of Raw Plati- num, 682.	
The Extraction of Platinum in the Wet Way . . . . .	682
St. Petersburg, 682.	
Extraction of Platinum in the Dry Way . . . . .	685
Deville and Debray's Processes, 685.	

## CHAPTER XIII.

## SULPHUR.

Principal Sulphur Ores . . . . .	689
Native Sulphur, 689. Metallic Sulphides, 689. Artificial Pro- ducts, 689.	

Synopsis of Processes for the Extraction of Sulphur .	690
Theory, 690. Methods, 690. Refining the Sulphur, 691.	
Recovering Sulphur from the Residues of the Soda Manufacture . . . . .	691
Methods of Gossage, Favre, and Noble, 691. Methods of L. Mond, Schaffner, and P. W. Hofmann, Patented in England, 691. L. Mond's Process, 692. Schaffner's Process, 699. Hofmann's Pro- cess, 699. Process in operation at Dieuze, 699. Spencer's Method, 705. Classification of the Processes, 706.	
Extraction of Sulphur from Sulphurous Earths . . . . .	706
Smelting very Rich Ores in Pans . . . . .	706
The richest Sicilian Sulphurous Earths, 706.	
Liquation of the Sulphur in Apparatus . . . . .	707
Sicilian Furnaces (Calcarelle) and Covered Heaps (Calcaroni), 707. Former Method in Sicily in Cylindrical Furnaces, 707. Classi- fication of the Sicilian Ores, 708. Mode of Liquation in Milos, 708. Methods in Spain, 708. Liquation in Covered Heaps, 708.	
Distillation of Sulphur in Closed Vessels (Tubes, Retorts, or Pans) . . . . .	710
The Furnaces used in Swoszowice, 710. The Distillation Process at the Solfatara of Pouzzales, 712. Improvement of the Pro- cess, 713. Distillation at Radoboi, 713.	
Extraction of Sulphur from Iron Pyrites and Pyritic Ores . . . . .	714
Extraction of Sulphur from Iron Pyrites in Closed Vessels . . . . .	714
Altsattel in Bohemia, 714. Rosenau in Silesia, 715.	
Extraction of Sulphur from Iron Pyrites in Cupola Furnaces . . . . .	716
Johann-Georgenstadt, 716. Breitenbrunn, 716. Simbirsk (Russia) 717. Brunfaut's Method, 718.	
Refining or Purifying the Raw Sulphur . . . . .	717
Purification of Sulphur by Re-melting . . . . .	717
Lower Hartz, 717.	
Purification of Sulphur by Distillation . . . . .	718
Marseilles, 718. Dujardin's Method, 720. Method in some German Establishments, 721.	
<b>SUPPLEMENT . . . . .</b>	<b>723</b>
Comparisons of the Dimensions of different Reverberatory Fur- naces, and the Conclusions to be drawn from them.	



# LIST

OF

## WOOD ENGRAVINGS.

---

### LEAD.

FIGS.		PAGES.
1—4	Reverberatory Furnace for the Carinthian Process . . . . .	27, 28
5, 6	Double Reverberatory Furnace in use at Bleiberg, &c. . . . .	30
7, 8	Reverberatory Furnace used at Davos. . . . .	32, 33
9, 10	English Reverberatory Furnace in use in Flintshire . . . . .	38
11, 12	Slag Hearth used at Alston Moor . . . . .	42
13—16	Castilian Furnace . . . . .	48
17, 18	French Reverberatory Furnaces . . . . .	56
19—22	Reverberatory Furnaces with a Fire-place on each side . . . . .	60, 61
23, 24	— Furnace used at Escalette . . . . .	67
25, 26	Scotch Hearth Furnace . . . . .	69
27, 28	American Hearth Furnace . . . . .	74
29, 30	Vogl's Cupola Furnace. . . . .	77
31	— New Cupola Furnace . . . . .	80
32—36	Cupola Furnaces used at the Upper Hartz. . . . .	101—104
37—41	— — — — — for Reducing Litharge. . . . .	101—104
42—44	— — — — — Lower Hartz . . . . .	122, 123
45—49	Furnaces which are a combination of Reverberatory and Muffle Furnaces used at Freiberg for Roasting Ores . . . . .	120—131
50—53	Wellner's Double Cupola Furnace used in Freiberg . . . . .	132—135
54, 55	Reverberatory Furnace used in Freiberg . . . . .	139, 140
56—58	— — with Two Hearths, one above the other . . . . .	151
59, 60	English Reverberatory Furnace for Reducing Litharge . . . . .	173
61—63	Lead Calcining Furnace with Cast-iron Hearth Pan . . . . .	193, 194

### SILVER.

64, 65	Cupola (Sump) Furnace used for Raw Smelting . . . . .	230
66—68	Liquation Hearth . . . . .	250
69—72	Apparatus for Pattinson's Process . . . . .	261, 262
73, 74	Reverberatory Furnace for Reducing Dross . . . . .	263
75—78	German Cupelling Furnace . . . . .	276, 277
79, 80	Cupelling Furnace used at Vialas in France . . . . .	291, 292
81—85	English Cupelling Furnace used at Stolberg (Prussia) . . . . .	296—298
86, 87	Refining Furnace used at Tarnowitz, (Hungary) . . . . .	308
88, 89	— — — — — Poullaouen (France) . . . . .	309
90, 91	— — — — — Przibram . . . . .	311

FIGS.		PAGES.
92, 93	Refining Furnace used at Mansfeld . . . . .	312, 313
94	Amalgamation Machinery used in Freiberg . . . . .	322
95	Section of the Amalgamation Works at Freiberg . . . . .	323
96	Apparatus used for Distilling the Amalgam in Freiberg . . . . .	328
97	— — — — — Arany-Idka . . . . .	329
98	Stamps for Crushing Ores (Molinos) in Mexico . . . . .	336
99	Grinding Mills (Arrastras) in Mexico . . . . .	336
100, 101	Apparatus for the Extraction of Silver used in Freiberg . . . . .	371
102—105	Double Roasting Furnace used at Mansfeld . . . . .	381, 382
106	Apparatus for Extracting Silver with Warm Water . . . . .	389

## ZINC.

107, 108	Cupola Furnace having a Fire-grate used in Spain for Calcination . . . . .	410, 411
109—113	Double Muffle Furnace for Calcination used in Przibram . . . . .	417—419
114, 115	Belgian Furnaces for Distillation . . . . .	431
116	Retort and Adapters used on the Continent . . . . .	432
117, 118	Furnace for Burning Muffles used at Liansamlet, near Swansea . . . . .	439
119, 120	Muffle Furnace used in England . . . . .	440
121	— and Adapters . . . . .	441
122	— Adapter used at Valentin Cocq . . . . .	449
123	Adapter used at Swansea . . . . .	449
124	Muffle and Adapter used at Borbeck . . . . .	449
125—129	Belgian-Silesian Distillation Furnace . . . . .	450
130	Muffle Furnace with Two Rows of Muffles one above the other used at Birkengang near Stolberg . . . . .	452
131, 132	Crucible Furnace used at Neath . . . . .	456
133, 134	Pots for Re-melting Zinc used at Liansamlet near Swansea . . . . .	460
135, 136	Reverberatory Furnace for Re-melting Zinc used in Silesia . . . . .	462

## TIN.

137, 138	Roasting Furnaces with Condensers, as used in Saxony . . . . .	478
139	Brunton's Calciner . . . . .	481
140, 141	Smelting Furnace used in Saxony and Bohemia . . . . .	492
142	Furnace for Re-melting Slags . . . . .	496
143, 144	Tin Smelting Furnace at Truro, in Cornwall . . . . .	499

## MERCURY.

145—148	Old Distilling Apparatus used in Idria . . . . .	511—513
149—152	Aludel Furnaces used in Almaden . . . . .	514, 515
153, 154	Hähner's Distilling Furnace . . . . .	519
155—157	Alberti's Distilling Furnace . . . . .	522
158—160	Gallery Furnace . . . . .	526
161—163	Ure's Furnace . . . . .	528, 529

## BISMUTH.

164—166	Retort Furnace for Liquefying Bismuth used in Saxony . . . . .	536
---------	--	-----

## ANTIMONY.

167	Apparatus for Liquefying Antimony used at Wolfsberg . . . . .	543
168	Furnace for Liquefying Antimony used at Malbosc (France) . . . . .	545
169, 170	Reverberatory Furnace for Smelting Roasted Antimonial Ores in France . . . . .	551

FIGS.		PAGES.
<b>ARSENIC.</b>		
171, 172	Retort Furnace used at Ribas (Spain) . . . . .	589
173—176	Arsenical Furnace used at Altenberg . . . . .	591
177, 178	Furnace for Refining Arsenious Acid used at Reichenstein . . . . .	597
179	— — Working Arsenical Pyrites used at Ribas . . . . .	600
<b>GOLD.</b>		
180	Section in the Clunes Gold Mining Field (Australia) . . . . .	615
181	— of a portion of the Ballarat Gold Field (Australia) . . . . .	616
182	— from the Boroondara and Balleen Gold Mines (Australia) . . . . .	616
183, 184	Gold Mills, used at Schemnitz . . . . .	632
185	Apparatus for Pressing the Auriferous Mercury . . . . .	633
186	— — Distilling the Amalgam . . . . .	634
187—189	— — Extracting Gold used at Reichenstein . . . . .	639, 640
190, 191	— — Extracting Gold used at Schemnitz . . . . .	644
192	— — Refining Gold used at the Lower Hartz . . . . .	667
193—196	— — Pressing the Silver used at the Lower Hartz . . . . .	668, 669
<b>PLATINUM.</b>		
197	Furnace for Melting Platinum Ores . . . . .	686
<b>SULPHUR.</b>		
198	Covered Heap for Liquating Sulphur . . . . .	709
199—201	Furnaces for Distillation used at Swoszowice . . . . .	710, 711
202	Apparatus for Distillation used at Radoboi . . . . .	713
203, 204	— — — — — Marseilles . . . . .	718
205—207	— — — — — Merxem . . . . .	720, 721

A PRACTICAL  
TREATISE ON METALLURGY.

---

CHAPTER I.

LEAD.

PRINCIPAL ORES OF LEAD.

IN these ores the lead is contained in the form of sulphide or oxide. The principal ores are the following :—

1. **Galena** (sulphide of lead),  $\text{PbS}$ , containing 86·57 per cent Pb, and 13·43 per cent S. It usually contains sulphide of silver in an isomorphous state. The amount of silver varies, in most cases, between 0·01 and 0·30 per cent, sometimes rising to 0·50, or even 1 per cent. In the latter case, however, silver does not occur as isomorphous sulphide of silver, but as silver ore disseminated through the galena. Upon treating galena by reagents, it may frequently be ascertained in what state of combination the silver exists in the ore. Malaguti and Durocher\* found silver in galena, from mere traces up to more than 7 per cent. The amount of silver varies not only in different deposits of the same locality, but sometimes even in the same bed, and is found to bear no relation whatever to the structure of the ore.

\* MALAGUTI and DUROCHER, in *Annales des Mines*, 4 ser., tom. xvii., 1805; FABRE, in *Bulletin de la Société de l'Industrie Minérale*, tom. iii., p. 281, 1857-1858. *Berg. u. hüttenm. Ztg.*, 1859, p. 446, 447.

It appears that the period of the formation of the ore has had an essential influence upon the amount of silver contained in it; galena in veins usually possesses a greater amount than galena in beds, or when diffused through other ores. Moreover, the purest galena contains the least silver. The prevailing opinion that lamellar galena contains more silver than granular galena, and that in the latter the silver occurs as mechanically included sulphide, is not always correct. Ores containing a small amount of lead, sometimes owe their entire value to the other metals, silver, gold, and copper, which they accidentally contain.

Galena is found in almost all countries, and in nearly all geological formations.\* It occurs:—

**A. IN CRYSTALLINE SLATES and UNSTRATIFIED ROCKS.**

*a.* In veins. In *gneiss* (Black Forest, Odenwald, Saxon Erzgebirge, Oberpfalz, Silesian Sudeten, Riesengebirge, Bleistadt in Bohemia, Central France, Kongsberg); in *mica schist* (Bleistadt in Bohemia, Spain, Kongsberg, Sardinia, Tuscany); in *granite* (Badenweiler, Sohneberg, Linares in Spain, Wicklow in Ireland, Central France); in *quartz slate* (Kongsberg); in *granular limestone* (Schwarzenberg in Erzgebirge); in *magnesian slate* (Sardinia); in *porphyry* (Central France, *i.e.*, Pontgibaud); in *trachytic porphyry* (Felsobanya, Kapnik); in *greenstone* (Schemnitz); in *greywacke, quartz, and greenstone* (Przibram).

*b.* In beds. In *mica schist* (Tuscany, Fahlun).

*c.* In floors. In *mica schist* and *granular limestone* (Ruszkitsza in Banat); in *mica schist, granular limestone, and syenite* (Dognaska, in Banat); in *granite* (Christiania); in *syenite* (Christiania); in *mica schist* (Tuscany).

*d.* Impregnated, in *granular limestone* (Sala).

**B. IN CAMBRIAN CLAY SLATE.** In *veins* (Cardiganshire, &c., in Wales).

**C. IN SILURIAN SLATES.**

*a.* In veins. In *clay slate* (Harzgerode on the Hartz, Mies in Bohemia, Carthagen in Spain).

\* Ann. d. Min., 4 ser., xvii., 83. Ueber das Vorkommen der Bleierze, *see* v. DECHEN, Statistik des nördl. and zollv. Deutschland, i., 750. CORTA, Lehre von den Erzlagertstätten, 1860, ii., 570 and 618.

*b.* In floors. In the *mountain limestone* of the Western United States. This limestone belongs to the Upper Silurian formation; and in its lower part is siliceous, in its upper part dolomitic.

D. In DEVONIAN SLATES.

*a.* In veins. In the *lower slates* (in the mountains of the Rhine near Trier, Coblenz, and Aix-la-Chapelle, in Nassau, on the right bank of the Rhine, Grand Duchy of Hussia, Andreasberg on the Hartz); in floors (Rammelsberg near Goslar).

*b.* In the *intermediate slates*. In veins, in Lenneslate and Eifel limestone (Cologne and Arnsberg); in beds (Meshede, Brilon, and Aix-la-Chapelle); in nests (district of Aix-la-Chapelle and Brilon, Iberg near Grund on the Hartz); in irregular masses (Breinig near Stolberg).

*c.* In the *upper slates*. In veins (Stolberg near Aix-la-Chapelle).

E. In COAL FIELDS.

*a.* In *carboniferous limestone*. In veins (Stolberg near Aix-la-Chapelle, district of Dusseldorf and Elberfeld); in lodes (Derbyshire and Cumberland); in irregular masses (district of Dusseldorf and Elberfeld).

*b.* In *bituminous shale*. In veins, (Upper Hartz, district of Arnesberg, Province Upper Hussia, Vosges, Poullaouen and Huelgoet in Bretagne, Culera in Catalonia); in contact groups (Christiania).

*c.* In *carboniferous formations without coal*. In veins (Gablau, in the district of Landshut; Eshhoff, in the district of Brilon).

*d.* In the *carboniferous formations containing coal*. In veins (Horst on the Ruhr, district of Waldenburg); in Silesian coal fields; in porphyry.

F. In the *Permian formation*. In some copper-slate; in the cupriferous shale near Gelnhausen in Prussia; in bituminous dolomite near Frankenburg; in the ash near Lauterberg; in the Hartz.

G. In the TRIASSIC FORMATION.

*a.* In *Vosges sandstone*. In veins (Katzenthal near Lembach in the Vosges).

*b.* In *new red sandstone*. In veins (Bavarian Pfalz, Baden

weiler in the Black Forest); in bunches, and in nests (Commer, Maubacher, Bleiberg near Düren).

c. In *shell limestone*. In beds (Reifelfingen and Bruchsal in Baden); as impregnations (Tarnowitz); in floors (Wiesloch, Tarnowitz, Olkusz in Polonia).

d. In *Keuper*. In nests, or impregnated in sandstone (Freiberg in Bavaria).

H. In the JURASSIC FORMATION. In veins (near Blankerode, in the district of Büren near Minden); impregnated, in beds, and in floors, in dolomitic limestone, and in ferruginous clay (Santander in Spain).

K. In TERTIARY ROCKS. In nests and in clay (Tarnowitz, Beuthen).

Galena occurring in veins is associated with either earthy minerals (quartz, calc spar, fluor spar, heavy spar), or with metalliferous minerals (blende, iron pyrites, sparry iron ore, arsenical and antimonial substances, &c.); sometimes it is associated with copper, zinc, silver, cobalt, and nickel ores. Malaguti and Durocher found silver in blende occurring in lead veins, from traces up to 0·88 per cent, and also traces in all the iron, copper, and arsenical pyrites which they submitted to examination. They also found that pure sulphuretted ores were always richer in silver than oxidised ores. Iron pyrites associated with galena sometimes contains gold (Hungary, Freiberg, Rammelsberg, Lautenthal on the Hartz). The commoner metals—iron, lead, zinc, and copper—are very frequently found together.\*

Lead ores occurring in beds, nests, floors, &c., are usually poorer in silver, but they contain a less proportion of other earthy and metallic minerals than those in veins. The deposits in the Rammelsberg form an exception to this.

2. **White Lead Ore** (carbonate of lead),  $PbO$ ,  $CO_2$ , containing 77·52 per cent Pb. If in admixture with clay, oxide of iron, &c., it is called *bleierde* (oxidised lead), and if mixed with coal, *black lead ore*. Of the oxidised lead ores the carbonate is the one which most frequently occurs; it is mostly found on the head of lead ore lodes, and is a secondary forma-

\* BREITHAUP, Paragenesis der Mineralien, Freiberg, 1849. ELIE DE BEAUMONT, Vertheilung der Elemente in der Natur. LIEBIG'S Jahresber, 1849, p. 785.

## WHITE LEAD ORE, SULPHATE OF LEAD, PYROMORPHITE. 5

tion derived from galena by atmospheric influence. In case the galena contains silver, a small amount of the latter (seldom more than 0·1 per cent) will pass over into the white lead ore. This ore sometimes occurs together with copper and iron pyrites, and also with various oxidised and sulphuretted metals. It is seldom found in large masses, and is mostly worked and smelted with galena. The most important localities where it occurs are at Diepelinchen near Aix-la-Chapelle, where the ore is found in nests in the Devonian rocks, and, together with bitumen, quartz, clay, and carbonate of zinc, in coal formations; in the Eifel mountains, where the ore occurs above the head of the new red sandstone, or as disseminated grains (Commern, Düren), or in layers and masses mixed up with clay; in the clay schists of the new red sandstone (Scheiden); it is furthermore found in different parts of Spain, as, for instance, in the province of Santander, mixed with calamine, clay, limestone, and dolomite; lead ores containing silver are found in quartz on the Altai mountains, associated with white lead ore, iron ochre, and other minerals; great quantities of this ore are also found in the Mississippi valley.

3. **Sulphate of Lead**,  $\text{PbO}, \text{SO}_3$ , containing 68·3 per cent Pb, is very rarely found in masses worth working. It occurs at Pallières near Alois, above galena lodes, but is poor in silver; also at St. Martin near Vega de Ribaddeo in Spain, together with phosphate of lead; and in the mines of Australia, where it contains, on an average, 35 per cent of lead and 35 ounces of silver to the ton, besides a small amount of gold. Sulphate of lead contains more silver than galena does.

4. **Pyromorphite**,  $\text{PbCl} + 3\text{PbO}(\text{PO}_3, \text{AsO}_3)$ , containing 69·5 to 76·2 per cent Pb, and never more than traces of silver. Some large deposits of this ore occur at Stolberg near Aix-la-Chapelle; at Ems; and at St. Martin in Spain, where it assumes the form of grapes.

5. **Yellow Lead Ore** (molybdate of lead),  $\text{PbO}, \text{MoO}_3$ , containing 57 per cent Pb. It is only found in association with other sulphuretted and oxidised lead ores; as at Bleiberg in Kärnthen, in some parts of Bavaria, &c.



### SYNOPSIS OF PROCESSES FOR THE EXTRACTION OF LEAD FROM ITS ORES.\*

THE extraction is done in hearth and cupola furnaces, and in reverberatory furnaces, either by a combined smelting process of oxidation and reduction, or by reduction and precipitation, the latter being always combined with some kind of purifying process. The particular process which should be adopted in any case, depends greatly on the price and quality of the smelting ingredients, such as the fuel, and also in a great measure on the quality of the ores, —whether they are in a sulphuretted or in an oxidised state; whether they are free from foreign sulphates and earthy substances; whether or not they are rich in silver, &c. In many cases, metallurgical traditions, and the industrial and commercial habits of different countries, are considered sufficient reasons for not introducing a more rational mode of operation than that which happens to be in use.

#### Influence of Foreign Substances contained in Lead Ores.

Foreign substances (sulphides and metalliferous minerals) occasion;

*a.* Loss of lead; by facilitating the formation of metallic fume in the furnace (sulphides of zinc, arsenic, and antimony); by rendering the ores more difficult of fusion (zinc blende); by forming sulphurous slags which are capable of retaining valuable metals, such as silver, copper, &c. (zinc blende); or by causing the ores to cake during roasting (sulphide of antimony in the reverberatory process) &c.

*b.* Deterioration of the lead (antimony, arsenic, and copper).

*c.* Deterioration, and a loss of lead at the same time by volatilisation (antimonial and arsenical compounds).

\* Du Plomb, de son Etat dans la Nature, de son Exploitation, de sa Métallurgie et de son Emploi dans les Arts, par LANDRIN. Paris, 1857. (B. u. h. Ztg., 1867, p. 332.) Métallurgie du Plomb et de l'Argent, par RIVOT. Paris, 1860. Rudimentary Treatise on the Metallurgy of Silver and Lead, by LAMBORN. London, 1861.

*d.* A favourable influence may be exerted by the presence of silver in galena, also of sparry iron ore and iron pyrites, after roasting, during the reduction process. The latter mineral exerts an unfavourable influence in the precipitation process. As most lead ores contain enough silver to make its extraction profitable, the process to be selected for the reduction of lead depends upon the method adopted for the extraction of the silver. These processes will be more fully explained in a subsequent chapter.

Earthy substances may exert a different influence, depending solely on their nature, such as whether they are basic or otherwise. Sometimes they are necessary for the formation of slags; in other cases they act very favourably (as lime does, in the reverberatory process); and in some particular cases their influence is positively deleterious (as, for instance, silica in the reverberatory process).

In the Preparation of the Ore it is of importance to take into consideration the influence of foreign substances, and accordingly to carry out the dressing, *i. e.*, mechanical purification, to a greater or less extent. The richer the ores are concentrated, the less cost and loss of lead will be occasioned in smelting; but this preparation can only be effected with a great sacrifice of ore, especially if it contains much silver, and if the latter is derived, not from isomorphous sulphide of silver, but from disseminated silver ores, which are mostly of less specific gravity than lead ores. It is therefore advisable to separate galena poor in silver, more completely from its earthy and metallic impurities than galena rich in silver. The economical limit of the concentration of ores is to be ascertained only by extensive, exact, and tedious trials; and such limit depends in each case on the quality of the ore, as well as on local circumstances. Rivot\* has given suggestions for such experiments.

Of the metallic impurities in galena, the Copper Pyrites is separated with difficulty, and with considerable loss of lead and silver; in consequence of this, the lead and

\* *Traité de Métallurgie*, tom. ii. *Métallurgie du Plomb et de l'Argent*, 1860, p. 4.

other products obtained from smelting cupriferous galena will be also cupriferous; and as in most cases they also contain silver, these metals must be extracted by separate processes.

**Iron Pyrites** is also somewhat difficult to separate, but it very rarely acts perniciously; sometimes it has a disadvantageous influence upon the melting mixture by augmenting its amount of sulphur (precipitation process); but, in most cases, a certain amount of iron pyrites in galena is advantageous (roasting reduction process). If iron pyrites is disseminated through galena, some part of it may be separated by hand sorting, but this cannot be effected by the ordinary dressing process.

**Grey Copper Ore** and **Bournonite** render the resulting lead impure, and facilitate its volatilisation, but they admit of an advantageous extraction of copper; the first-named mineral also assists in the extraction of silver. The greater the amount of silver the less the dressing is to be carried on, on account of the small specific gravity of the fallow copper ores. In the melting process antimonial and arsenical products are formed, which are difficult to roast, owing to their easy fusibility; and the metals contained in them can be extracted only with great loss.

**Blende**, under all circumstances, has an injurious influence upon the melting process, and can be only partly separated from galena, on account of its great specific gravity. This is also the reason that the dressing of galena, when associated with blende, and poor in silver, may be carried on further than when the galena is rich in silver. Galena containing 15 per cent of blende may still be worked advantageously in reverberatory furnaces. If galena contains more than this amount of blende, it should be smelted in cupola furnaces, though in this process also, blende occasions loss of lead and silver by volatilisation, by a formation of fume in the furnace, and by rendering the slags, &c., more difficult to fuse.

**Sulphide of Antimony** is often found so finely disseminated through galena that its separation by a mechanical process is impossible, and it occasions loss of lead and silver in the melting process on account of its volatility; it also renders the

working of the resulting intermediate products difficult (for instance, the cupelling of the raw lead), and it renders the pig lead impure. Antimony is equally injurious whether the ores are smelted in reverberatory or in cupola furnaces. **Arsenical Pyrites** behaves in a similar manner.

Of the earthy associates of galena, **Calc Spar** and **Fluor Spar** are the most important; these are seldom much disseminated in it, and, in most cases, can be separated mechanically without loss of metal; they also frequently exert a very favourable influence upon the melting process: indeed, in some cases, when galena does not already contain them, they should be added.

**Quartz** is often found accompanying galena; and this mineral, as well as aluminous substances, causes the more loss of metal the finer the ore has to be pulverised for its preparation, and in many cases they cannot be separated sufficiently to become innocuous in the reverberatory process.

**Heavy Spar** is very difficult to separate from galena on account of its great specific gravity, and it is not possible to prepare ores containing it sufficiently pure for the reverberatory process without great loss of metal. The economical working of these ores can therefore, in most cases, be only effected when the sorting is done by hand. An amount of 15 per cent of heavy spar in galena renders the reverberatory process difficult. If such ores are worked in cupola furnaces, the heavy spar acts disadvantageously, by augmenting the mass, and thus occasioning the use of an increased amount of fuel.

**Oxidised Lead Ores**, in association with earthy substances, can be dressed without difficulty, but they occasion great loss if they are associated with galena. In rare instances only are they so rich in silver that any considerable mechanical loss of it may take place in the preparation. This may happen if clays containing silver occur together with lead ores.\*

\* Bulletin de la Société de l'Industrie Minérale, iii. 287.

The chief modes of extracting lead from its ores, at present adopted, may be classified under the two following divisions:—

I.—SMELTING OF SULPHURETTED LEAD ORES.

*a.* The **Reverberatory Process** is used, in general, for ores rich in lead, and poor in foreign sulphides and earthy matters, and especially silica; it is not often employed, and only for the treatment of ores containing much silica, when fuel is cheap (French precipitating process). It may be subdivided into—1. *Roasting reaction processes*, which consist in the removal of the sulphur, partly by roasting and partly by the reaction of the oxidised substances in the mass upon the sulphuretted ones; the following are modifications:—The *Carinthian Process*, used for very pure ores, free from silica. These ores are treated in small quantities, in reverberatory furnaces with inclined hearths, from the bottom of which the reduced lead (as chief product) continually runs off, whilst a smaller quantity of lead is obtained by mixing coal with the residues, which are rich in oxide. This process is adopted at Bleiberg in Carinthia, Holzappel, Graubündten, and in Spain. The *English Process* is employed for calcareous ores rich in lead; upon treatment of the larger bulks in reverberatory furnaces furnished with a sump, metallic lead, subsulphide and oxysulphide of lead will be formed; the two latter are decomposed by lime and coal. This process is in use in England, Spain, and was tried in the Hartz. The *French Process* is adopted for ores containing pyrites and some silica; upon treatment in reverberatory furnaces with a sump, little lead and a great deal of oxide of lead are formed, the latter being reduced by coal. This process is employed at Poullaouen, Pezey, Corfali, Stolberg, and Tuscany, and the smelting works on the Rhone. It is also tried on the Upper Hartz. 2. *French Precipitation Process*. In this the siliceous galena is decomposed by iron. It is employed at Vienne, Poullaouen, Corfali, and Tuscany, and the smelting works at Marseilles.

*b.* The **Hearth Furnace Process** is used for very pure galena, when fuel is expensive, or of inferior quality; the reactions are similar to those in the English reverberatory process.

There are two modifications of this process. The first is, smelting in *North American hearth furnaces* with hot blast ; in this only the very purest galena is used. It is generally adopted in North America, and it has been tried at Bleiberg, and Przibram. The second is, smelting in *Scotch hearth furnaces with cold blast* ; the galena used need not be pure, but should be free from silica, and previously roasted in reverberatory furnaces. This process is in operation in Cumberland, Northumberland, Durham, and Pezey.

c. **The Cupola Furnace Process** is used for galena containing a larger amount of foreign sulphides and earths, or silica, and which is suited neither for the reverberatory process nor for that in hearth furnaces. Pure galena is seldom used. This process is subdivided into—1. *Precipitation Process*. In this the unroasted earthy galena is decomposed by metallic iron ; the galena must be as free as possible from foreign sulphides (Upper Hartz, Victor-Friedrichs-hütte, Joachimsthal) ; the decomposition is effected by ferruginous fluxes :—by iron ore (Ruszyberg) ; by iron cinders produced in the refining process (Kinzig-thal) ; by roasted raw matt (Sala) ; by ferruginous lead matt slags (Clausthaler, trials with the reverberatory furnace) ; and by such fluxes in combination with metallic iron (Tarnowitz, Przibram, Münsterthal, Ems). 2. *Common Lead Process*. Used for smelting galena containing a larger amount of foreign sulphides, and more or less earthy matter ; it is seldom employed for melting purer and only earthy lead ores (Commern, Stolberg). The operations are :—Roasting in heaps (Lower Hartz, Müsen, Rothenbach) ; in mounds (Fahlun, Rhone smelting works) ; or in reverberatory furnaces (Przibram, Freiberg, Commern, Stolberg, Lower Hungary, Holzappel, Pontgibaud, Vialas, Rhone smelting works, Tuscany, Spain) ; reducing and purifying smelting of the roasted ore in cupola furnaces, with or without ferruginous fluxes, or with such fluxes in combination with metallic iron ; the details depend on the quality of the ores, and the price of the smelting materials. There are the three following subdivisions of the common lead process : the first is adapted for the working of ores poor in lead and very siliceous, by roasting and reducing without ferruginous



fluxes (Lower Hartz, Fahlun). The second is employed for the working of siliceous and earthy ores richer in silver, by smelting them, after roasting, with ferruginous fluxes; with ores containing crude matt (Lower Hungary); with roasted raw matt (Freiberg); with iron ore (Vialas); with refinery cinders (Tuscany, Spain, Rhone smelting works); or with such fluxes in combination with metallic iron (Przibram, Holzappel, Musen, Rothenbach, Pontgibaud). The third modification is employed for working earthy ores richer in lead, by roasting and smelting with iron ore (Commern), or with refinery cinders (Stolberg).

## 2.—TREATMENT OF OXIDISED ORES AND PRODUCTS.

*a. White Lead Ores.*—Reduction smelting of rich ores in reverberatory furnaces, and of poor ores in cupola furnaces (Altai, Münsterbuch, near Stolberg, Southern Spain), or in air furnaces (Southern Spain).

*b. Sulphate of Lead.*—Working in reverberatory furnaces (Poullaouen, processes of Rivot and Phillips, and Völckel), and in cupola furnaces (Southern France).

*c. Litharge.*—Reduction in reverberatory furnaces (England, Holzappel, Ems, Poullaouen); in cupola furnaces (Upper Hartz, Lower Hartz, Freiberg, Przibram, Tarnowitz); in Siberian hearth furnaces (Barnaul, Freiberg, Fernezeley); in Scotch hearth furnaces (Tuscany, Pontgibaud, Pezey).

*d. Dross.*—Melting the dross in reverberatory furnaces, and producing hard lead in cupola furnaces (Upper Hartz, Lower Hartz, Przibram, Freiberg, Holzappel, Müsen, &c.)

*e. Bottoms of Lead Furnaces.*—Melting in reverberatory furnaces (Siberia), and in cupola furnaces (Tarnowitz.)

*f. Lead Slags.*—Melting in reverberatory furnaces for producing raw matt (Freiberg), and in cupola furnaces for producing lead (Tarnowitz, Hettstadt, Sardinia, Spain).

The raw lead produced from any of these ores or products is refined by various processes. The following are those generally adopted:—Skimming off the dross (Upper Hartz, Lower Hartz); stirring with wood shavings (reverberatory process in England, France, &c.); stirring with wooden poles (Altenau Lead Works, Ramsbeck); Pattinson's process

(Altenau, Freiberg, Stolberg); oxidation smelting in air reverberatory furnaces (England, Stolberg, Rouet); oxidation smelting in cupola furnaces (Freiberg, Antonshütte); smelting with oxidising and purifying fluxes (methods of Baker, Pontifex, and Glassford).

## DIVISION I.

### SMELTING OF SULPHURETTED LEAD ORES.

The production of lead is effected in hearth, cupola, and reverberatory furnaces. Galena free from earthy substances and foreign sulphides, or containing only small quantities of lime, heavy spar, and blende, is advantageously worked on hearths and in reverberatory furnaces; but those ores which contain a large amount of earthy and siliceous substances, as well as other metallic sulphides, are best treated in cupola furnaces, though local circumstances sometimes render the employment of reverberatory furnaces advisable also for these ores. The choice of a reverberatory furnace or a hearth furnace, for pure galena, depends chiefly on the quality and price of the available fuel, and for this reason hearth furnaces are principally used in those countries where good coal is expensive, and wood and turf cheap.

**THE REVERBERATORY PROCESS** is simple, very economical, and occasions the least loss of metal; it admits of the use of raw fuel, and of the process being watched throughout. It occasions but a small residue, and requires neither blast machines nor expensive fluxes. On the other hand, this process is only adapted for very pure ores containing little or no silica; small amounts of lime, heavy spar, and zinc blende, are not so injurious. As objections to this process, compared with the cupola furnace process, we may mention the loss of copper in poor copper schlich, a deterioration of the resulting lead by its alloying with copper, and, lastly, greater difficulties in making the slags profitable. The different modifications of the reverberatory process are dependent on the presence of foreign substances, and also on the greater or less amount of silver contained in lead ore. Although the smallest quantity of silica contained in galena occasions a loss of



metal, fuel, and time, yet if the ore is worked in reverberatory furnaces, it is still possible that local circumstances may recommend this process likewise for ores which are rich in silica.

The different reverberatory processes may be thus classified, according to their chemical reactions, and according to the quality of the ores :

#### A. THE ROASTING REDUCTION PROCESS.

*a. Carinthian Process*, for very pure galena, poor in silver, and for ores containing a small amount of lime.

*b. English Process*, for galena containing more lime, and sufficient silver to make it worth extracting, and also containing some zinc blende and heavy spar.

*c. French Process*, for ores containing a large amount of pyrites, blende, and earthy matters, but not more than 5 per cent silica, and more or less silver.

#### B. DECOMPOSITION OF GALENA BY MEANS OF IRON.

*French Precipitation* or *Vienne Process*, for ores containing much quartz and aluminous substances, with more or less silver.

#### A. DECOMPOSITION OF GALENA BY ROASTING PROCESSES IN REVERBERATORY FURNACES.\*

In all these processes the three following periods are to be observed :

*Period 1.* (Roasting.) Galena is roasted at a more or less increased temperature for a longer or shorter time, and is thereby converted more or less into oxide of lead and sulphate of lead; part of the galena, however, remains undecomposed. If the temperature is raised rapidly, less sulphate of lead will be produced than when the temperature is raised slowly, or continued for a longer time. The most suitable temperature, and the proper time required for the roasting, depend on the quality of the ore; and it is essential

\* Theorie des Flammöfen processes. KARSTEN, Arch. 1, R. vi., 110. UEBER die Entschwefelung des Bleiglanzes. *Ibid.*, vi., p. 328. Ann. des Min., 1833, tom. ii., p. 3. LAMPADIAS, Fortschritte, 1839, p. 55. PUVIS, Theorie der Zugutemachung des Bleiglanzes in Flammöfen. KARSTEN, Arch. i., R. vi., 236. KERL, Ueber die Zugutemachung der Bleierze in Flammöfen, B. u. h. Ztg., 1854, p. 165. PHILLIPS, in B. u. H. Ztg., 1859, p. 368. RIVOT, Métallurgie du Plomb et de l'Argent, 1860, p. 32.

to know whether the ore contains substances which may cause the operation to proceed more rapidly, as in this case there is danger of a slagging together of the mass, thereby injuring the entire operation.

Pure galena requires a lower temperature for roasting, and hence there is less loss of lead by volatilisation (Carinthian process) than when calcareous galena is employed (English process); whilst galena containing pyrites must be roasted at a temperature rising gradually but not getting too high (French process).

Amongst foreign substances which may be present, **Quartz, Clay, and Silicates** generally, exert an injurious influence even when not more than  $\frac{1}{4}$  or  $\frac{1}{2}$  per cent of silica is present, by forming at the commencement easily liquefied slags, which cover the roasting mass like a varnish, and render perfect oxidation impossible. If the ore contains from 5 to 6 per cent of silica, the reactions are seriously interrupted, and the more so the more the silica is disseminated through the galena.\* It appears, also, that a finer grain of the pounded and dressed ores assists the formation of slags.

**Lime**, in not too considerable quantity (10 to 12 per cent), acts advantageously both in the roasting process, by rendering the mass more difficult of fusion, and also in the reactions of the 3rd period.

**Iron Pyrites** assists in the more rapid conversion of galena into oxide and sulphate of lead.

**Sulphide of Antimony** is injurious even when in small quantities (2 to 3 per cent); it facilitates a caking together of the mass, occasions loss of silver and lead on account of its volatility, and gives rise to the formation of an antimonial lead. **Arsenical Pyrites** is less injurious, as it only occasions a loss of metal. **Grey Copper Ore**, on account of the quantity of antimony, arsenic, and sulphur it contains, acts like sulphide of antimony; it also occasions the formation of cupriferous lead.

\* Versuche zu Poullaouen und auf dem Oberharze über den Einfluss des Quarztes, Thonschiefers und Kalks. B. u. h. Ztg, 1854, p. 193, 228. BERTHIER'S Metall. Analyt. Chemie, ii. 643.

**Copper Pyrites** does not interfere with the roasting process, but is objectionable on account of the copper present.

**Sparry Iron Ore** may be injurious, if silica is present at the same time, by forming easily fusible silicates of iron ; but it is serviceable in the subsequent reactions.

(The action of the above-named substances has been proved by trials in reverberatory furnaces executed at the Clausthal Lead Works.\*)

*Period 2.* (Heating the mass for the production of metallic lead, by the reaction of the oxidised upon the sulphuretted constituents.)

If the roasting mass, by frequent stirring and by a diminished oxidising flame, is quickly brought to a cherry-red heat, the oxide and sulphate of lead react upon sulphide of lead in such a way that metallic lead is produced. This may be proved by experiments on a small scale. † When the oxidised components have given their oxygen to the sulphur of the excess of galena, and no more lead is produced, the roasting process may be commenced again at a lower temperature, and the oxide and sulphate of lead formed can be made to react upon the remaining galena, by raising the temperature and stirring the mass till the lead again ceases to run off. This roasting and reaction is repeated until no more lead is produced, and the mass commences to liquefy. The first or chief roasting depends on the nature of the ore, on the temperature of the roasting, and on the time it is carried on ; the quantity of the resulting lead depends partly on the purity of the galena and partly on the care bestowed on the process. It is of importance not to allow the temperature to rise above a cherry-red heat during the lead extraction ; if a higher temperature is employed, a loss of lead by volatilisation will take place, and also a greater amount of lead will be kept back in the slags. Oxide and sulphate of lead are transformed, with galena, into metallic lead and sulphuric acid

\* KERL, Oberharzer Hüttenprocesse, 2 Aufl., 1860, p. 579. B. u. h. Ztg., 1854, p. 201.

† PLATTNER, in B. u. h. Ztg., 1854, p. 22.

only at a somewhat low temperature ; if a higher temperature is employed, oxysulphide will be formed, which does not decompose galena. Towards the end of the second period the temperature must be considerably raised, for the purpose of extracting the lead as completely as possible from the roasting mass, which now contains the foreign substances in a more concentrated state, and has become much more difficult to fuse. The formation of oxysulphide of lead cannot therefore be avoided, and it will be retained in the residue together with undecomposed galena, oxide of lead, and sulphate of lead. The quantity of oxysulphide of lead left in the residue depends upon the nature of the foreign substances contained in the lead ore.

The longer the reactions can be continued without rendering the mass liquid, the less oxysulphide will be formed (if blende, iron pyrites, sparry iron ore, &c., are associated with the ore). The further treatment of the residues for the extraction of the remaining lead depends on this.

In the second period, foreign substances occurring in galena may act either advantageously or injuriously. The latter is always the case if they are present in the galena in large quantities, as they then mechanically prevent the oxidised and sulphuretted substances having that complete contact which is necessary for the reaction.

**Carbonate of Lime** acts favourably if present in small quantity, as it decomposes galena, as well as sulphate of lead, and by preventing the too easy liquefaction of the mass facilitates the reaction ; a proportion above 12 per cent is disadvantageous, owing to its mechanical action.

**Fluor Spar** acts in a similar manner. Its fusibility will assist the liquefaction of the mass, but it eliminates a small amount of silica by forming gaseous fluoride of silicium. Combinations of fluor spar with heavy spar and sulphate of lime are easily fusible.

**Heavy Spar**, in small quantity, has no influence. But 12 per cent or more interferes mechanically, and increases the bulk of the residue.

**Quartz, Clay, and other Silicates** render the mass easily

fusible; as little as 6 per cent, if well mixed, almost prevents the reactions.

**Zinc Blende**, nearly all of which is converted by the roasting process into oxide and sulphate of zinc, acts advantageously in small quantity. By rendering the charge less fusible, a more frequent repetition of the roasting reduction process is practicable, and, in this way, poorer slags are formed; but the reactions are mechanically prevented if the quantity present exceeds 10 or 12 per cent. Galena containing still more blende (20 to 25 per cent) can sometimes be made available for the reverberatory process by being mixed with pure galena, the average amount of blende being thus reduced to 12 or 15 per cent.

**Iron Pyrites**, by the roasting process, is converted into oxide and sulphate of iron, and towards the end of the second period the increased temperature converts it into peroxide of iron. It renders the charge less fusible, and the undecomposed sulphide of iron extracts lead from oxide of lead. Iron pyrites in greater quantity prevents the reactions to some degree, and facilitates the formation of matt, which being easily fusible, runs off and causes loss of metal. Arsenic in iron pyrites always causes the production of an arsenical lead, and great loss of lead and silver by volatilisation, though the greater part of it will have been volatilised during the roasting period as well as by the farther treatment of the slags.

The injurious influence of sulphide of antimony has been already mentioned. (Page 15.)

**Copper Pyrites and Grey Copper Ore** cause the formation of impure lead; the first of these minerals also occasions the formation of matt and cupriferous residue, from which, by further treatment, a cupriferous lead is produced.

**Sparry Iron Ore**, in the roasting process, is chiefly converted into peroxide of iron. It renders the charge less fusible, and thus enables the roasting reduction process to be oftener repeated; in consequence of this a very complete decomposition of the galena takes place, and the residue becomes poor in lead, containing mostly oxide and sulphate of lead, and but very little oxysulphide. A greater amount

of this ore, like the other named substances, interferes mechanically.

**Sulphide of Silver** decomposes at a low temperature, and the silver becomes more concentrated in the former portions of the extracted lead than in the latter. When the lead from the different periods of the reverberatory process is collected together, the average amount of silver in the whole mass may be too small to admit of profitable extraction. Fallize\* has proposed to extract part of this silver by Pattinson's method, and to retain for this purpose the first portions of lead, which are richer in silver. Gold, when in galena, behaves in a similar manner.

**Carbonate of Lead**, when present along with galena, not only occasions a material shortening of the time of roasting, but allows most of the lead to be extracted at a low temperature at the beginning of the reduction period. It also produces less liquid slags. The lower the temperature at which the lead is extracted, the purer the metal; there will also be less loss by volatilisation, and the foreign metals will be sooner oxidised and volatilised. Care must be taken that most lead is extracted during the first reaction of the oxides upon the sulphates and sulphides, as the higher temperature of the subsequent reactions increases the loss of lead.

Amongst other circumstances which influence the success of the process may be mentioned the skilfulness and care of the workmen. Setting aside the influence of the above-described impurities, success also depends upon exact roasting, a judicious amount of firing, a proper stirring up of the mass, and upon the right dimensions of the furnace. If the dimensions differ from those fixed and sanctioned by experience, it will be difficult for the workmen to carry out the operations and regulate the temperature correctly, and the yield of metal, its loss by volatilisation, and the consumption of fuel, &c., will be affected.

The same furnace is generally used for roasting and reducing; sometimes, however, separate furnaces are employed. The iron tools used for working the mass also exert some influence upon the production of lead. The higher

\* B. u. h. Ztg., 1860, p. 359.

the temperature the more liquid the mass becomes, and the more oxide, sulphide, and sulphate of lead will be decomposed by the iron. In consequence of this the iron tools are sometimes worn away rapidly, causing considerable expense.

*Period 3.*—(Treatment of the residue of the slags.) At the end of the second period there remains in the furnace a more or less molten mixture of oxide of lead, sulphate of lead, silicate of lead (formed either from silica present in the ore, or by the combination of lead with the silica in the bottom of the furnace), oxysulphide and sulphide of lead, with foreign substances more or less transformed. The oxides act upon the sulphides in a pasty but not in a liquid state. In the latter case the oxysulphide is not decomposed, and, on the other hand, the uncombined oxides and sulphides do not come into sufficient contact with each other when molten. The residue, therefore, will produce no more lead by a continued roasting process, and becomes poorer in lead the longer the roasting is carried on at a low temperature (Carinthian process), or at a higher temperature, when the ores contain foreign substances, such as zinc blende, iron pyrites, and sparry iron ore. In no case, however, must the temperature be so high as to melt the mass.

The residues contain accordingly either an excess of oxidised (Carinthian and French processes) or of sulphuretted substances (English process); and they require, for the further extraction of the contained lead, either reducing agents (coal, wood) or calcareous fluxes, or both.

The third period is commenced by repeatedly mixing coal and lime, or first lime and then coal, with the residue, and working them together at an increasing temperature. Carbon is used in the form of non-caking coal, small charcoal, fragments of wood, &c. It reduces to the metallic state the free oxide of lead and that contained in the oxysulphide, and brings the sulphate of lead to sulphide of lead, which becomes desulphuretted by the influence of another part of oxide of lead.\* The porous condition, occasioned by the

\* GAY LUSSAC, *Zersetzung der schwefelsauren Metallsalze durch Kohle.* ERDM., J., f. pr. Chem. xi., 65.

reducing gases which rise and permeate the mass, facilitates the reaction.

This process of mixing with wood, suddenly raising the temperature, and working up the residue, is repeated as often as lead is extracted; and in this way the slags obtained are usually poor in lead and rich in silver (if present in the original ore), and the lead in the slags is found in the state of sulphide of lead. This is, therefore, an appropriate mode of treatment for galena containing but little silver, when the resulting slags can be obtained sufficiently free from lead not to require working up again in another furnace, which would be necessary if they contained a larger amount of silver and lead, occasioned by the presence of foreign substances. In case the residues contain much oxide of zinc, part of the zinc becomes reduced and volatilised, lead and silver going along with it.

Burned lime, in form of powder, may be recommended as an admixture for the residues, if they are richer in sulphide of lead than in oxides. It acts partly mechanically, by preventing the liquefaction of the masses, and by making them spongy, thus promoting the reaction of the sulphides upon the oxides; and it acts in part chemically, by decomposing sulphate, silicate, and sulphide of lead; this last decomposition takes place only in the presence of air, when metallic lead and sulphate of lime are formed. In the absence of air, lime scarcely decomposes sulphide of lead. If no more lead is produced after repeated mixing with lime, increasing the temperature and working up the mass, the slags may be removed. They contain more or less lead, but are very poor in silver, as they are chiefly composed of oxides, sulphate and silicate of lead, and lime; it may, therefore, be recommended to employ lime when working galena rich in silver, as it is more advantageous to extract the greatest part of the silver by means of the lead of the 2nd period, and thus to leave a minimum amount in the slags.

But be the galena poor or rich in silver, it is always desirable to endeavour to obtain, by skilful manipulation, as little slag as possible. When working galena, rich in silver, lime must be used for the decomposition of the



residues, and when working galena poor in silver, lime or coal may be used according to whether the residue contains more oxidised or sulphuretted substances. This, again, depends on the original impurities in the ore, and on its treatment in the first two periods; which treatment greatly depends on these impurities.

The products of the reverberatory process are :—

1. **Lead**, with a varying amount of silver, and of different degrees of purity. Though the ores from which this lead is produced contain no injurious substances, yet the metal usually contains small particles of ore mechanically mixed up with it, which cannot be separated when the lead has been removed from the furnace and cooled. It also contains small amounts of sulphur, sub-sulphide of lead, or other sulphides (sulphide of iron from iron pyrites, or derived from the iron tools). On stirring up the lead with wood, before cooling, these impurities rise to the surface, and may be skimmed off. Copper, antimony, or arsenic, cannot be extracted in this way, and to remove them the lead must be refined. When poor in silver, it becomes, without further preparation, a marketable product (Carinthian lead); if it contains sufficient silver to render its extraction profitable, it is either cupelled (Poullaouen), or previously treated by Pattinson's process; if necessary, it may also be previously refined.

The following are analyses of such lead by Streng. *a* is lead from Villach; *b* is the best selected English lead :—

	Pb.	Sb.	Cu.	Zn.	Fe.
<i>a.</i>	99·9660	0·0260	Trace	0·0039	0·0041
<i>b.</i>	99·9800	0·0150	Trace	0·0008	0·0042

2. **Residues**.—These consist of variable mixtures of oxides, sulphates, silicates, and sulphides, combined with coal or lime, according to which substance was used for the lead extraction. If these residues contain but little lead, either they are thrown away, or the lead, which is mechanically included, is separated by pounding and washing them. If they contain a larger amount of lead, they require a subsequent smelting with iron in hearth or cupola furnaces, and sometimes in reverberatory furnaces. The latter mode occasions

greater loss of lead by volatilisation, and more interruptions, than melting in cupola furnaces. The resulting lead is then either refined, and sold as such, or, if it contains a sufficient amount of silver, is treated by Pattinson's process.

The following is the composition of the residues from the reverberatory furnaces at Bleiberg, analysed by Ferjentsik :—

	Pb.	Zn.	Fe.	MgO	CaO.	S.
1.	69.6	—	1.5	6.3	5.5	16.1
2.	39.7	18.1	1.7	5.0	10.5	24.5
3.	45.5	15.9	0.7	6.8	8.7	22.3
4.	32.6	18.9	4.5	1.7	13.9	28.3
5.	21.7	31.4	1.3	1.3	13.6	30.5
6.	24.7	27.9	1.1	2.3	13.7	29.2
7.	26.4	26.1	4.5	1.7	12.0	29.2
8.	31.5	27.9	2.0	1.1	9.6	27.4
9.	41.7	30.8	1.8	—	1.8	24.0
10.	27.9	35.6	7.8	—	1.3	27.3
11.	34.9	24.2	6.5	—	7.5	27.0
12.	26.2	27.8	7.8	—	8.9	29.3

3. **Lead Fume or Smoke** is formed, partly mechanically, when fine particles of ore, at the moment of their transformation into carbonate and sulphate of lead, come into contact with the hot gases during the charging of the furnaces, and during the roasting process; it is also formed by the volatilisation of metallic lead during the second period. There is less volatilisation the more the lead is extracted at the commencement of the second period, when the temperature is still low; in the later periods this loss will also be less, as the masses under treatment are then poorer in lead. The fume consists usually of oxide, carbonate, and sulphate of lead, and a little sulphide of lead, with more or less silver. Silver is volatile at very high temperatures, but most of it is carried off mechanically at the commencement of the process, together with the ore dust, and it probably becomes reduced from the sulphuretted to the metallic state when in contact with hot air.

The formation of lead fume is frequently so considerable that it is advisable and economical to collect it in proper condensation flues. It is then useful for melting up with fresh ore, for, on account of the lead-salts it contains, it considerably shortens the time of roasting. Sometimes the fume is smelted, together with the residues, in cupola furnaces. In this case it must be mixed with clay or lime, to

prevent too great a loss of metal from reduction and volatilisation in the upper parts of the furnace, as well as its being mechanically blown out of the furnace.

The following analyses show the composition of different kinds of lead smoke :—

	PbO.	PbO,SO <sub>3</sub> .	AsO <sub>3</sub> .	Fe <sub>2</sub> O <sub>3</sub> .	ZnO.	PbO,CO <sub>2</sub> .	PbS.	Al <sub>2</sub> O <sub>3</sub> .	SiO <sub>3</sub> .	Clay.
1.	11'0	60'0	2'0	12'0	15'0	—	—	—	—	—
2.	—	39'0	1'5	—	2'7	35'0	4'5	—	13'2	—
3.	10'2	65'6	—	3'4	13'8	—	1'4	—	5'6	—
4.	42'6	39'0	—	—	—	—	—	—	17'4	—
5.	71'2	—	—	trace	—	—	—	7'2	20'6	—

1. Smoke from a roasting reverberatory furnace at Pontgibaud, by Berthier. 2. The same, by Rivot. 3. The same of Alston Moor, by Berthier. 4. Fused lead smoke of Conflans, by Berthier. 5. Caked smoke from the chimney of the reverberatory furnace at Redruth, by Berthier. In addition, No. 2 contained 2'3 per cent of ZnO,SO<sub>3</sub>, and No. 5 contained 0'2 per cent of Cu.

According to Rivot, the smoke of schlich melting furnaces at the Upper Hartz contains—

*Sulphuretted Substances.*

C.	S.	As & Sb.	Pb.	Fe.	Zn.
2'5	7'8	0'5	34'8	1'0	1'0

*Oxidised Substances.*

CO <sub>2</sub> & O	As & Sb	SO <sub>3</sub>	PbO, SiO <sub>3</sub>	PbO	ZnO	Fe <sub>2</sub> O <sub>3</sub>	SiO <sub>3</sub> & BaO, SO <sub>3</sub>
7'7	2'5	2'8	2'9	18'0	1'5	4'5	12'3

4. Reverberatory Hearth Ends.—The hearth being made of clay is impregnated with more or less sulphuretted, oxidised, and metallic lead. It may be smelted together with the residues.

**a. THE CARINTHIAN REVERBERATORY PROCESS.**

In general this process produces a perfectly pure lead, a good yield, and very little slags; which are, moreover, so poor in lead that they may be thrown aside. This can only be effected by using very pure ores, and being content with a small production and a comparatively great consumption of fuel, time, and labour. Therefore the purer the ores and the cheaper labour and fuel (wood) are to be had, the more satisfactory will be the result. The manipulation consists in roasting the galena during the first period at a gradually increasing temperature, until oxide and sulphate of lead are

produced in sufficient quantity to admit of the extraction of the greater part of the lead during the second period, by then raising the temperature and repeatedly manipulating the roasting mass. The following equations represent the reaction which takes place :

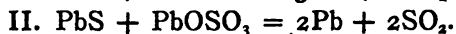

Galena also is partly transformed, during roasting, into subsulphide of lead ( $\text{Pb}_2\text{S}$ ), from which the lead is extracted likewise by the oxidised components.\* The lead obtained at the lower temperature (virgin lead) is allowed to run at once on the inclined hearth, out of the furnace, in order to lessen the loss by volatilisation; this lead is of great purity. By continually stirring up the roasting mass, fresh portions of galena are caused to oxidise, and by the reaction of the oxides upon the sulphides the extraction of lead is continually going on. The galena thus becomes more and more decomposed until it reaches a point at which the roasting mass is chiefly composed of oxide and sulphate of lead and small quantities of oxysulphide of lead; this compound now gives no more lead by simply heating. Here commences the third period, *i.e.*, working up of the remaining dough-like mass at a higher temperature, and mixing it with coal or wood. By this operation the free oxide of lead and the oxide contained in the oxysulphide become reduced, and the sulphide of lead liberated from the latter, as also the sulphide which has been reduced from the sulphate of lead, become transformed into metallic lead by the surplus oxide of lead; so that at last there will remain a comparatively small quantity of slag, poor in silver and not worth further working. If the galena used contained much silver, the remaining slags will retain a certain amount of it, owing to their combined sulphur. The lead (press lead) extracted at the higher temperature, is less pure than the virgin lead, as the compounds of foreign metals which may be present, get more reduced at the higher temperature of this period than in the earlier stages. A subsequent melting of this impure

\* PLATTNER, in B. u. h. Ztg., 1854, p. 22.

lead in the reverberatory furnace will purify it. To carry out the process economically the following requirements are necessary:—

1. **Pure Ores**, which may contain a small amount of lime, heavy spar, and blende, but must be as free as possible from silica and silicates. An amount of even  $\frac{1}{4}$  to  $\frac{1}{2}$  per cent of silica entails a great loss of time, fuel, and metal, by prolonging the roasting, unless neutralised by a corresponding addition of lime. It appears that a small addition of lime is advantageous to the yield even when the ores are free from silica.\* A greater amount of foreign substances, though it may not interfere chemically with the reaction, always prevents the lead drops upon the inclined hearth running together, and causes them to remain longer in the furnace, in consequence of which they partly volatilise or combine with the slags after becoming oxidised. The ores must be poor in silver, or the resulting slags will have to be worked up again.

2. **A Perfect Control of the Temperature**.—This is only possible when using light charges and furnaces of small dimensions, and by having the grate at the long side of the hearth so that the flame may act equally on all parts of it. Such charges give a comparatively small production of lead, and require larger consumption of fuel, time, and labour. If the charges are increased in order to raise the production, the slags will become richer and the yield proportionately less. If the reaction is effected at a low temperature, the yield is greater, and the lead produced is of finer quality.

3. **The use of Wood as Fuel**.—Wood lies more loosely on the grate, and allows the passage through it of the surplus air which is essential at this period of the process, as it assists the oxidation of the galena. A coal fire has not this advantage. As a great deal of wood is burned, the process can only be profitable when it is very cheap (say to £1 worth of ore, £1 worth of wood). Brush-wood is only used in the Spanish lead works, and necessitates a particular construction of the furnace.

\* Oestr. Zeitschrift, 1856, p. 254.

## Illustrations of the Carinthian Process.\*

**Ores.**—At Bleiberg and Raibl, in Carinthia, the galena, † poor in silver, is found in layers in Tyrolese limestone, associated with blende, calamine, some iron pyrites, sparry limestone, fluor spar, and heavy spar, together with the rarer minerals, wolfram, red lead, and vanadium lead ore. Quartz and silicates only occur in very small quantities. The zinc blende contains a larger amount of silver than the galena. After dressing, the ores contain 65 to 72 per cent of lead, and only 8 to 10 of gangue, mostly carbonate of lime with a little blende and heavy spar. The richest are those schlich obtained by buddling the ore; washed products are not so rich.

**Furnaces.**—The smelting furnaces do not require for their construction very refractory materials (red sandstone); usually two furnaces are placed side by side, and have but one chimney. (Figs. 1 to 4), *a*, is the grate, having 4 inches space

FIG. 1.

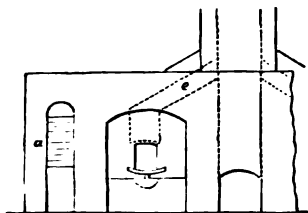
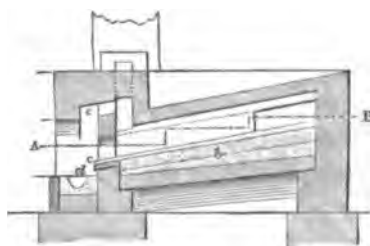

FIG. 2.



between the fire bars; *b*, the sloped hearth. The inclination increases from 8 to 40 inches, and is formed of two layers, 6 inches thick, the lower one of which is composed of pressed

\* VON BORN'S, *Bergbaukunde*, 1789, ii. 80. KARSTEN, *Metallurgische Reise*, Halle, 1821, 198. Ueber die Kärnthner Bleihütten: Reisen eines Ungenannten durch einige Theile von mittägl. Deutschland, Erfurt, 1795. BOULANGER, über die Schmelz-processe in Bleiberg; *Annales des Mines*, 3 sér. vii. 167. LAMPADIUS, *Hüttenkunde*, ii. Thl. 2 Bd. 263. KARSTEN, *Archiv. i. R.* vi. 197. PHILLIPS, *Mittheilungen über den Bergbau bei Bleiberg in Kärnthnen*; *Annales des Mines*, iv. sér. tom. viii. 5 livr. de 1845. *Bergwerksfreund*, xi. 161. KARSTEN, *Métallurgie*, v. 95. WEHRLE, *Hüttenkunde*, ii. § 913—921. RIVOT, *Métallurgie du Plomb et de l'Argent*, 1860, p. 298. BAUER, in KRAUS' *Oesterr. Jahrb.* 1855, p. 364.

† *Erzvorkommen*: COTTA, *Erzlagerstätten*, 1861, ii. 341. *Alter des Raibl Bergbaus*, *Bergwerksfreund*, xvi. 313. *Verwaltungsberichte der K. K. Berghauptmannschaften über Verhältnisse und Ergebnisse des Oester: Bergbaus in den Jahren. 1855 und 1858*, Wien, 1856 und 1859.

FIG. 3.

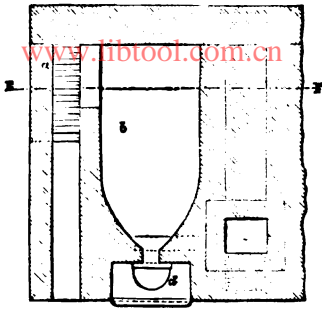
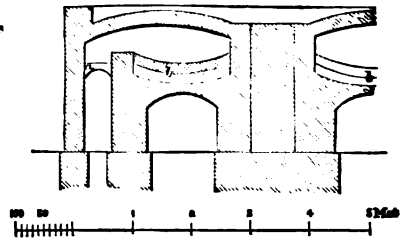

FIG. 4.



clay, and the upper one of furnace residues made compact by exposure to a strong fire. *c*, are iron plates to rest the iron tools on. *g*, trough for receiving the lead, formed out of coal-dust, 18 inches long, 16 broad, and 10 deep. *e*, is the flue for collecting the lead smoke.

The furnace, still red hot from the last charge, is, after the upper layer of the hearth is repaired, charged with 4 cwts. of ore, which is uniformly spread over the hearth. The grate still contains glowing coal from the preceding charge, and it is, therefore, not necessary to put wood upon it during the first three hours of roasting. The roasting mass, during this period, is only stirred up eight or nine times by means of cast-iron rabblers. At this stage of the operation three or four pieces of fir-wood are put upon the grate, and now, for about four hours, the period of the stirring at a somewhat higher temperature, continues. The roasting mass is manipulated until no more lead runs from the sloped hearth. One hour is now allowed for oxidation, the fire is re-stirred, and the smelting mass worked up again; and these operations (alternate roasting, reacting of the oxides upon the sulphides, and continually shortening the intervals of oxidation) are carried on until the mass in the furnace, now at a bright red heat, begins to frit. The resulting residues are then stiffened, by mixing them with a little small coal, and removed from the furnace. A second charge is then worked in the same manner. The first charge yields about 154 lbs., and the second 123 to 132 lbs. of virgin lead. The residues of both operations are then worked together.

At the period of the *pressing*, the residues of both charges are first mixed together in the bright red-hot furnace, and the heat is kept up for an hour. The mass is continually being worked up, and about 44 lbs. of less pure lead (press-lead) is reduced, chiefly by the reaction of the coal which has been mixed up with the mass. After fifteen hours, about 3 cwts. of lead are collected in the reservoir, the result of a consumption of 33 to 34 pieces of wood, and the masses become pasty at the cherry-red heat of the furnace. By adding more wood, 4 or 5 pieces per hour, the temperature is again gradually raised for seven or eight hours, whilst the masses are continually worked up, and a spade-full of small coal or wood mixed up with them, till no more lead is produced, and the furnace has attained a very high red heat. About 2 cwts. of lead are produced during this last period. The residues, amounting to about 12 or 13 per cent, are removed from the furnace, and if they contain as much as 7 or 8 per cent of mechanically mixed lead, they are pounded and washed. Poorer slags are thrown aside or used to repair the hearth. The lead resulting from all these operations is run out from the reservoir upon the floor of the smelting-house, and re-melted in the lower part of the reverberatory hearth: this re-melting requires about twenty-five minutes.

A double charge of 8 cwts. of ore yields in twenty-four hours, about 5 cwts. of lead in pigs, with a consumption of 81 to 85 pieces of wood. The ores containing, according to the dry assay, 65 per cent, but in reality at least 69 per cent of lead, yield about 60 per cent; there is, therefore, a loss of lead amounting to 9 or 10 parts for 100 parts ore, or 14 to 15 per cent on the lead contained in that ore. The loss in rich ores is therefore very trifling; but taking into consideration the small production, the cost for fuel and labour is large. The cost per ton of ore amounts to—

	£	s.	d.
Wood (1·60 ton) . . . . .	0	8	10
Labour . . . . .	0	10	0½
Tools, repairs, &c. . . . .	0	2	7½
Total . . . . .	£1	1	6



If the workmen produce more lead from the ore than it is reported to contain according to the assay, they are allowed a premium of about 3 farthings for each 22 lbs. of lead gained ; but, on the other hand, they have to pay a penalty of 1½d. for every 22 lbs. if they produce less ; this is after deducting 2, 3, 4, 5, 6, &c. per cent loss, which is allowed for ores containing 82, 80, 78, 74 per cent. In the same way the workmen are paid a premium of 7½d. for every 6 cwts. of wood which they save ; having to pay 1s. 2½d. for each 6 cwts. used beyond the allowance.

For working two charges of ore, each workman receives 2s. 9d. Two furnaces produce 180 tons of lead per annum, consuming 300 tons of ore and 480 tons of wood. Two assistant workmen are required, each receiving about 1s. wages for a day's work of 12 hours, and also six workmen for 725 shifts of 23 hours each, receiving 3s. 2d. per shift. The expense for tools amounts to £20, and the total cost per annum is £326 8s. One cubic metre of the wood employed weighs about 6 cwts. ; therefore 1 ton (= 1,000 kilogr.) occupies a space of about 3'3 cubic metres.

The following improvements have been introduced in order to increase the production of lead, and to lessen the expense of fuel and labour.

The smelting has been carried out in double furnaces, in which there are two hearths placed one above the other ; the flame of the lower being conducted over the upper one. Figs. 5 and 6 will serve to explain the general form and construction

FIG. 5.

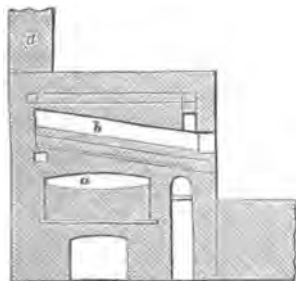
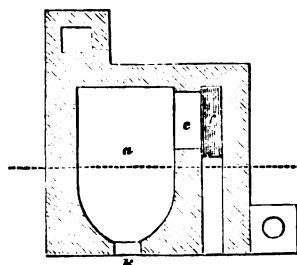

FIG. 6.



of the furnaces used since 1840, at Bleiberg, Kreuth, and Raibl. The flame, after passing over the lower hearth *a*, enters the upper one, *b*. On this a charge of  $8\frac{1}{2}$  cwts. of pounded and washed ore is roasted for about eleven hours, at a temperature not exceeding  $800^{\circ}$  C., giving an average yield of  $1\frac{1}{2}$  cwts. of lead. On the lower hearth a previously roasted charge is at the same time worked in the way already described. This operation requires rather more than eleven hours, and yields from two charges of  $16\frac{1}{2}$  cwts., nearly 11 cwts. of lead when the worked ores contain 72 per cent lead, and 10 cwts. 36 lbs. lead, when they contain 69 to 70 per cent of lead. The yield of lead in double furnaces is somewhat higher than in single furnaces, as the roasting is more complete and the temperature lower. The cost both of fuel and labour is also less.

The cost for 1 ton of ore, yielding 0.620 to 0.650 ton of lead, amounts to—

	£	s.	d.
Wood (1.11 ton) . . . . .	0	6	$1\frac{3}{4}$
Labour . . . . .	0	9	$11\frac{1}{2}$
Tools, wear and tear, and sundries . . . . .	0	2	$7\frac{1}{2}$
Total . . . . .	£0	18	$8\frac{3}{4}$

About 302 tons of ore, yielding 189 to 198 tons of lead, may be worked annually in a double furnace. In spite of these favourable results, double furnaces have been abandoned for single furnaces, as the repairs in double furnaces are so frequent and expensive that they outweigh the advantages, and, moreover, they require more skill and intelligence on the part of the workmen. The supposed advantages of the double furnace led to the construction of furnaces with three hearths, one above another; but these were also unsatisfactory.

North American lead hearths were first tried in the year 1843, but they are used only for very pure ores. A greater loss of lead results, though less fuel is used.

**Production.**—In Carinthia there were produced in 1860, by the Aerar Smelting Works, 17,773, and by private smelting works, 52,086 cwts. of lead, at an average expense of about £1 10s. per cwt. This is about five-ninths of the annual lead production of Austria, which amounts to 125,000 cwts. The Carinthian lead is celebrated for its purity, and is sold

under the name of Villacher lead, taking its name from the town of Villach.

At Holzappel, in Nassau,\* the purer ores were formerly smelted in Carinthian furnaces, which are now only used for the reduction of litharge, the ores being worked in cupola furnaces. At Davos,† in Graubündten, ores containing 64 to 68 per cent of lead, and 3 to 4 per cent of quartz, 8 to 10 per cent of lime, fluor spar, and a little blende, are smelted in furnaces having the fire-grate at their narrower side, as is shown in the accompanying sections (Figs. 7 and 8) where *a* is the grate; *b*, fire bridge with side flues *c*; *d*, hearth; *e*, lead sump; *f*, chimney piece; and *g*, chimney.

FIG. 7.

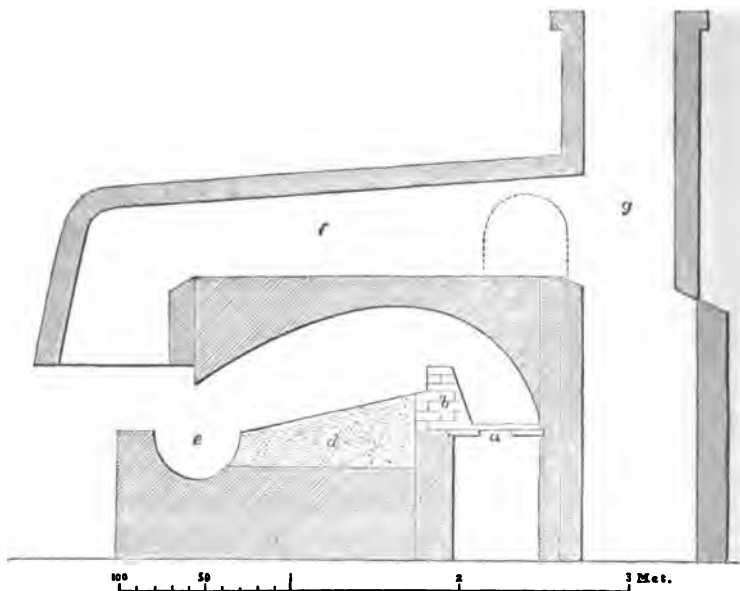

Charges of  $1\frac{3}{4}$  cwts. are smelted every six hours. They are first roasted, and then allowed to react upon each other at an increased temperature, during which operation most of the lead runs off; the temperature is then lowered

\* *Erzvorkommen zu Holzappel*, COTTA's *Erzlagerstätten*, ii., 143, 667.

† *Erzvorkommen zu Davos*: DEICKE, in *B. u. h. Ztg.*, 1859, p. 178. *HUTTENBETRIEB, KARST.*, Arch. I., R. vi., 204. *KARST. Metallurgie*, v., 102. *WEHRLE'S Hüttenkunde*, ii. 257. *Revue Universelle*, 5 ann., 3 livr., 1861, p. 360.

FIG. 8.

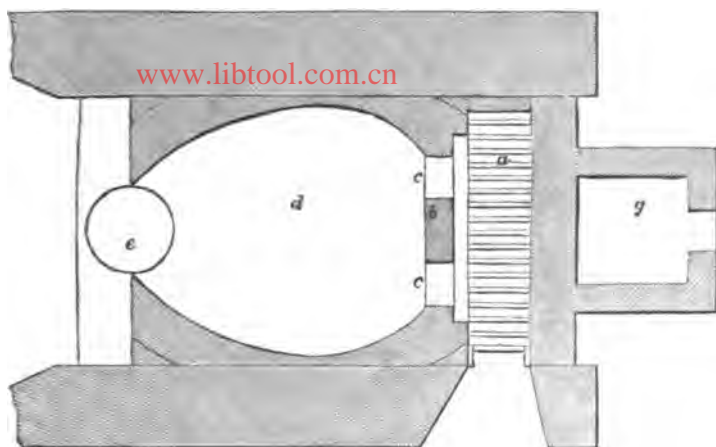

for a short time, charcoal and green wood are added, and again the temperature is raised. In this way an additional quantity of lead is extracted, and the processes of roasting and reduction are once more repeated. Finally, the ashpit is completely closed, the working door partly closed, a cast-iron plate put into the lead basin, and the lead stirred up with a wooden pole. The lead is skimmed, and the scum returned to the hearth, whilst the lead is run into the moulds.

7 cwts. of ore yield in twenty-four hours, 4 cwts. of crude lead, and 33 lbs. of slag, containing zinc and about 3 per cent of lead, at a consumption of about 18 cwts. of wood, 22 lbs. of charcoal, and 11 lbs. of green wood. When the slags have accumulated sufficiently, they are roasted and reduced in quantities of 4 cwts. at a time. Two workmen attend to the furnace for twenty-four hours. The expense this time being 12s. 3d. for fuel, 3s. 2d. for wages, and 10d. for tools, each cwt. of crude lead costs, therefore, 4s. In Carinthian furnaces the same amount of lead is produced with less expenditure of fuel and labour.

In the interior of Southern Spain\* the reverberatory furnaces

\* KARSTEN'S *Met.*, v., 101. *Ann. d. Min.*, 3 sér., xix., 215, 239. *Bergwfd.*, v. 113. *B. u. h. Ztg.*, 1850, p. 82; 1855, p. 254, 347; 1861, p. 349, 1862 p. 52.

(Boliche, Reverberero de Cuba, Reverberero Castellano) have the form of cupelling furnaces, with a circular hearth of 1·98 to 2·25 metres diameter, the arched roof being 1·20 metre from the hearth. The hearth is sometimes not circular, but square; this is supposed to concentrate the heat better. The hearth is furnished with a trough of about 0·45 to 1 metre in width for the collection of the lead, from which again the lead is run by means of a canal into a rectangular basin of about 1 metre square, placed outside the furnace. The fire-place is solid, without either grate or ashpit, as only wood chips, branches, and brush wood are used as fuel; and it has been proved by experiments that when this fuel is burned upon grates it does not produce a sufficiently equal temperature. In order to produce as complete an action of the fuel as possible, there is a contracted part opposite the working door which obstructs the hot gases. These pass the bridge by means of channels round the sides and also over the top, when they come to a second elliptic or three-cornered hearth, whence they escape by a channel into the chimney.

Charges of about 12 cwts., containing 72 to 75 per cent of lead, and consisting of  $\frac{2}{3}$  ore,  $\frac{1}{3}$  of very rich slags, and  $\frac{1}{10}$  lead skimmings, are thrown in every 20 to 25 minutes; the charge is spread over the hearth about 0·25 metres deep (a little higher near the bridge), and is kept at a red-heat till no more drops of lead appear; the mass is then stirred up, and the temperature gradually increased so long as lead runs off. When this ceases, charred fuel and ashes are added, which act partly by reducing and partly by rendering the slag liquid by reason of the alkali in the ash. The slag then flows into the sump, and thence out of the working door.

The contents of the sump are then stirred up, the rich slags are again mixed with coal near the bridge, and the lead is run from the furnace. The above charge yields in about 5 hours,  $5\frac{1}{2}$  to 7 cwts. of lead, equal to 45 to 48 per cent of lead, and 40 per cent rich residue, containing 18 to 22 per cent of lead, and yielding 12 to 15 per cent when smelted in small cupola furnaces. About 3 tons of wood are used every 24 hours; and the cost for smelting amounts to 10d. for each cwt. of ore, and to 1s. 9d. for each cwt. of lead.

**b. THE ENGLISH REVERBERATORY PROCESS.**

In this process coal is used, and the object is to obtain as large a production as possible. Therefore larger furnaces, having three working doors on each side, are employed, so as to admit of greater charges and a quicker working at high temperatures. In consequence of this high temperature, a great deal of oxysulphide of lead is formed; and although it is for the most part decomposed by lime, still it enriches the slags so much as to render it necessary to re-smelt them, either in cupola or hearth furnaces. For this reason the yield of lead is smaller than when Carinthian furnaces are used. Attempts have been made to lessen the loss of metal by volatilisation by constructing extensive smoke-condensing flues. The purer the ores are the more favourable the result, and a small amount of lime in the ore is advantageous (Flintshire.) If the ores, in consequence of a greater amount of lime and heavy spar, are poorer (Derbyshire, Wales), the regular English process, as adopted in Flintshire, is somewhat modified. Silica, if only to the extent of 1 or 2 per cent, is always disadvantageous, and causes a scorification of lead at the high temperatures required for the process. The presence of sulphide of antimony also facilitates scorification. By this method it is possible to smelt ores which are rich in silver, as well as those which contain little silver, the presence of lime preventing the formation of rich argentiferous slags. According to the purity of the lead and the amount of silver it contains, it is either sold direct, or is cupelled, or worked by Pattinson's process.

The general outline of the English process is as follows:—Larger quantities of galena are roasted for a short time at a rapidly increasing temperature. In this way there will be less oxidised product in comparison with the undecomposed galena than in the Carinthian process. If the charge is exposed in this condition to a higher temperature, lead and sub-sulphide of lead will be formed by the action of the oxides upon the sulphide:

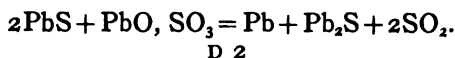

D 2

As soon as the lead ceases to run off, the temperature is lowered; the subsulphide of lead, consisting of 92·8 per cent of lead and 7·2 per cent of sulphur, becomes decomposed into sulphide of lead and metallic lead, as it can only exist at a high temperature, but not in a pasty state. If air is admitted during the cooling, part of the sulphide is oxidised, and upon raising the temperature metallic lead is again produced. The object is to extract as much lead as possible by a rapid alternation of temperature, and repetition of the calcining and reduction. As the temperature rises, a point will be reached at which the charge becomes liquid, and the oxy-sulphide fuses. To decompose this, an addition of lime and air is necessary. When by this means no more lead is extracted, the remaining rich slags must be removed from the reverberatory furnace, and afterwards treated in a cupola or hearth furnace.

Owing to the large charges and the rapidity with which the different roasting and reduction periods follow each other, the yield of lead is not so great as in the Carinthian process; but skilful smelters are able to extract, in well-constructed furnaces, 60 per cent of the lead contained in the ores, besides that which is afterwards extracted from the residues by means of lime. A certain quantity of white lead ore in galena considerably shortens the time of roasting; it gives a larger yield of lead at a lower temperature during the second period, and lessens the quantity of slag.

The hollow or funnel-shaped hearth is furnished with a sump for collecting the reduced lead. Slight alterations in the dimensions of the furnace are found to diminish the yield of metal, and increase the consumption of fuel. When working rich ores, the calcination and reduction are effected in the same furnace; but poor ores, especially those containing pyrites, are worked in different furnaces. The English smelter generally uses more fuel, but works with less loss of metal than the German. The expense of the English process is comparatively small, and the profit or loss of smelting works therefore chiefly depends on the price of the ore and the percentage of metal extracted.

### Illustrations of the English Process.

This process is carried out in the normal manner in Flintshire,\* at the lead works of Walker, Parker, and Co., Deebank; and of Keates, at Bagilt; at the Panther leadworks in Bristol; at the lead works, Gallongate in St. Anthony, near Newcastle-upon-Tyne, &c.

**Ores.**—English lead ores† occurring in carboniferous limestone, are mostly very pure when dressed. They contain 70 to 75 per cent of lead, and 8 or 10 ounces of silver to the ton; the lead ores occurring in veins in the Cambrian clay slate in Cardiganshire, on the west coast of Wales, are richer in silver. Valuable lead ores are also found in the clay slate rocks (killas) of Cornwall, in the Isle of Man, &c. Besides these ores, others from Sardinia, Spain, America, &c., are smelted in English lead works. Ores containing much quartz are not bought at all; those which happen to contain a little quartz are carefully mixed with ores free from silica; and ores poor in silver are mixed with ores rich in silver. The normal process can be properly carried on only with rich (70 to 75 per cent) and calcareous ores.

**Smelting the Ore.**—The English reverberatory furnaces differ from all other lead furnaces in being much larger. They vary in different smelting works, and they also have three working doors on each side of the hearth. The furnaces at the lead works in Flintshire are represented in Figs. 9 and 10, with the dimensions given. *a* is the grate; *b*, the fire-bridge; *c*, the hearth, composed of a mixture of quartz sand, a little ferruginous clay, and poor slags. The hearth is sometimes formed of slag alone, which is then heated in the furnace with closed doors, in quantities of 7 or 8 tons at a time, until it assumes a semi-fluid condition; it is then

\* DUFRENOY et EL DE BEAUMONT, *Voyage Métallurgique en Angleterre*. Paris, 1827, Ann. d. Min., 1 sér., xii., 361, 401; vii., 73; 2 sér., vii., 3, 14; xvi., 404. JARS, *Metallurg.*, Reise iii., 916, 945, 949. KARSTEN'S Arch., 1 R., xiv., 302, 358, 361. RUSSEGER'S Reisen, iv., 493. KARSTEN'S *Metallurgie*, v., 103, WEHRLE'S *Hüttenkunde*, ii., 301. PHILLIPS' *Manual of Metallurgy*. London, 1852, p. 489. RIVOT, *Métallurgie du Plomb et de l'Argent*, 1860, 316. B. u. h. Ztg., 1859, p. 368. Berggeist, 1861, No. 39.

† *Annales des Mines*, 5 sér., xi., 391. COTTA, *Erzlagerst*, 1861, ii., 494, 499,



FIG. 9.

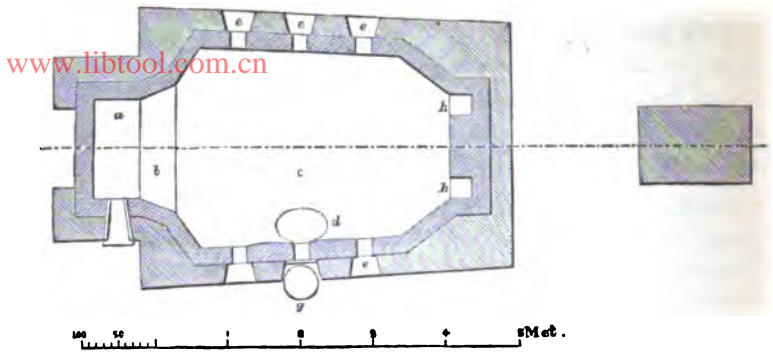
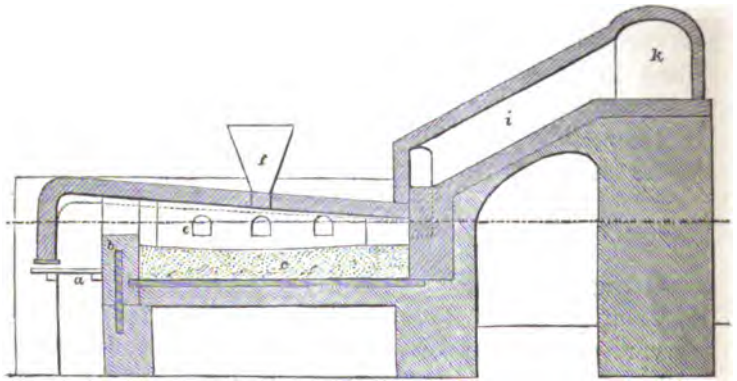

FIG. 10.



worked into the proper form with rakes and paddles. This hearth rests upon a layer of fire-bricks, very carefully arranged. *d* is the lowest point of the hollow or funnel-shaped hearth, the so-called *sump*, in which the reduced metal is collected, so as not to expose it too long to the strongly heated draught of air. From the sump the lead can be run off through a hole into the exterior basin, *g*; this tap hole, when not in use, is closed with a pellet of clay; besides this there is usually a hole on the labourer's side of the furnace, and one at the surface of the metal bath in the sump for drawing out the slags. *e, e* are working doors, lined with iron plates, 0.25 metre wide and 0.20 metre high, on the interior, and 0.50 metre wide and 0.40 metre high, on the exterior, and situated 1.33 metre above the floor of the

smelting-house; they are capable of being tightly closed, when necessary, by means of iron plates. *f* is a hopper for supplying the furnace with ore, by means of a valve, or a lid, with which it is furnished; during the smelting process it is covered with a cast-iron plate. *h*, *h* are flues, 0·30 metre wide, and 0·45 metre high, communicating with a chimney 1 metre square in the interior, and 20 metres high, by the inclined channel *i*, and the horizontal channel *k*. The channels *i* and *k* are either considered sufficient for condensing the lead smoke (as at Deebank), or separate condensing apparatus is constructed for this purpose, as, for instance, at the Panther Lead Works.

It is always advisable to employ these condensing chambers with cupola furnaces, and they are also always used with slag and Scotch hearths; but as they usually injure the draught, they are sometimes omitted with reverberatory furnaces.

The interior of the furnaces is built with fire-bricks, and the outside with common bricks; between the two a hollow space is left, 0·05 metre wide, filled with some non-conductor of heat. The furnaces are strongly fastened with grappling irons, and each requires for its erection about 5,000 common and 2,000 fire bricks, and 2½ tons of clay. The furnaces in the north of England are somewhat smaller, but in Cornwall they are larger.

In Flintshire the following treatment of ores containing 70 to 75 per cent is adopted. The furnace, still hot from the previous operation, is charged with 1 ton of ore (in Newcastle charges of 12 to 14 cwts. are used, while in Cornwall charges of 30 cwts. are sometimes worked), the damper being lowered whilst the galena is being spread out, and until it has ceased to decrepitate. The damper is then partially raised, and a sufficient fire made up to keep the temperature at a low red heat. During this period, called the *first firing*, which lasts for about two hours, the doors must be kept close, and the ore turned over with the rake about five times. As soon as drops of lead make their appearance, and the development of white vapour ceases, the doors are shut, the damper raised a little more, and the temperature

increased for the *second firing*, which lasts about twenty minutes, when metallic lead and some slag flow into the sump. The doors are then opened, the mass turned over, and the slag raked away so as to uncover the lead on the hearth; lime is then added, and the doors again opened, so as to allow the contents of the furnace to cool slightly. In about three and a-half hours' time the *third firing* commences; in this the alternate roasting and strong firing is continued as long as lead is reduced, and the slag does not liquefy too much. In about five hours the contents of the furnace fuse at the increased temperature, and flow into the sump. The doors are again opened, and lime is thrown on the slag in the sump to diminish its fusibility. The stiffened mass is then drawn back and spread over the hearth, the doors are closed, and a good fire kept up for five or ten minutes. The mass in the furnace is next well turned over, by which means lead is allowed to run out, and the alternate lowering and raising the temperature is repeated, with a frequent addition of lime, until lastly, after about six hours' work, the slags yield no more lead, and are drawn out. The hearth is then repaired and charged again, during which time the lead is tapped and run out of the sump into an exterior basin. The rich slags which have remained in the sump are placed on the hearth near the fire-bridge, where they are mixed with small coal and worked up so long as lead is produced from them; they are then added to the new charge. The lead which has collected again in the sump is tapped off, and the sump repaired. If on the surface of the lead in the outside basin some matt appears, which may have been formed by the use of iron tools, it is removed, the lead is then stirred about with small wood and coal, the oxide skimmed off, and the clean metal poured into moulds.

The resulting products are (1) very pure lead, sometimes containing as much as ten ounces of silver to the ton, which is worked according to Pattinson's process; (2) smoke from condensing flues, which is worked along with the smoke from the slag hearths; (3) slags for smelting in hearths, and furnace-bottoms, which are worked with the slags.

Four charges are smelted every twenty-four hours, consuming two tons of coal and about 3 cwts. of lime. Four workmen attend to the furnace, two of them working for twelve hours at a time. The wages for one man are about 3s. 6d. for twelve hours, but they vary according to the amount of ore worked, and the yield of lead. The under workmen receive 2s. for twelve hours. One ton of ore, containing 78 per cent of lead, yields 0·630 ton = 63 per cent of raw lead, containing 10 ounces of silver in the ton, and 0·250 ton (= 25 per cent) of slag, containing 40 per cent of lead, besides several pounds of smoke, containing nearly  $\frac{1}{2}$  per cent of the lead of the ore. If the produce from the smoke and the slag is estimated to be 0·094 ton, the yield of one ton of ore, which contains, according to the assay, 0·780, and in reality 0·810 ton of lead, amounts to 0·724 ton. The actual loss, therefore, is about 10 per cent.

The expenses for working one ton of ore by the reverberatory process (*a*), and including the additional expense for working up the slags and smoke (*b*), amount to—

	<i>a.</i>		<i>b.</i>	
	<i>s.</i>	<i>d.</i>	<i>s.</i>	<i>d.</i>
Labour . . . . .	4	10 $\frac{3}{4}$	6	10 $\frac{3}{4}$
Coal . . . . .	2	5 $\frac{3}{4}$	2	9 $\frac{3}{4}$
Coke . . . . .		—	0	9 $\frac{3}{4}$
Lime . . . . .	0	5	0	4 $\frac{3}{4}$
Tools, wear and tear, &c. . . . .	0	7 $\frac{1}{4}$	1	8
Total . . . . .	8	4 $\frac{3}{4}$	12	7

It was shown on page 29 that the expense of the Carinthian process was much greater, amounting to £1 1s. 6d. per ton.

According to Phillips,\* ores of 75 $\frac{1}{2}$  per cent yield, in the reverberatory process, 68 $\frac{1}{2}$  per cent, and the smelting of their slags and smoke, 2 $\frac{3}{4}$  per cent, making together 71 $\frac{1}{4}$  per cent of lead, which gives a loss of 4 $\frac{1}{4}$  per cent. The workmen receive for every ton of lead from 7s. 6d. to 12s. 6d., according to the quality of the ore. In the northern districts of England 12 cwts. of coal are used for 1 ton of ore, and the loss of metal when smelting ores of 60 per cent amounts to 12 per cent, 6 $\frac{1}{2}$  per cent of which is regained on working the smoke

\* B. u. h. Ztg., 1859, p. 379.

and slag. Phillips says that  $13\frac{1}{4}$  cwts. of coal are used for 1 ton of ore.

**Treatment of Slags.**—The slags are treated on the slag hearth on account of their porosity, which prevents their being smelted in cupola furnaces. Figs. 11 and 12 represent a hearth such as is used at Alston Moor, in

FIG. 11.

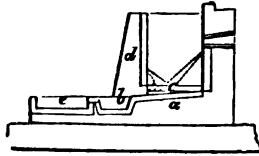
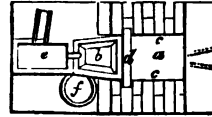

FIG. 12.



Cumberland, for the reduction of lead slag. It resembles the Scotch furnace; the shaft is a parallelopiped, the base of the area inside measuring 26 inches by 24 inches, and the height, 3 feet; the sole plate, *a*, of cast iron, slopes slightly down to the fore hearth, *b*. Upon each of the longer sides of the sole plate there are cast iron beams of great strength, *c, c*, called bearers, to support the side walls, built of a coarse-grained sandstone, and the cast iron plate, *d*, which forms the front of the shaft. This stands 7 inches from the sole plate, leaving an empty space between them. The back part is made of cast iron, from the sole plate to the horizontal tuyere in the middle; but above this point it is of sandstone. The tuyere is from  $1\frac{1}{2}$  to 2 inches in diameter. In front of the fore hearth, *b*, a cistern, *e*, is placed, through which water flows continually, so that the slags which overflow the fore hearth may become disintegrated, whereby the lead disseminated through them is readily separated by washing. The lead itself flows from the fore hearth, *b*, through an orifice, into an iron pot, *f*, which is kept over a fire. The whole bottom of the furnace is filled to a height of 17 inches (that is, to within 2 or 3 inches of the tuyere) with coke rubbish reduced to coarse powder and beat strongly down. After each smelting shift, this bed must be made anew, and the interior of the furnace above the tuyere repaired, with the exception of the front, which consists of cast iron. In front of the furnace there is a basin, which is also

filled with coke rubbish. Further off is the pit, full of water, which constantly runs in through a pipe. The slag flowing out of the furnace, passes over the coke bed into the basin, and then falls into the water, which makes it split up into small pieces, after which it is easily washed, so as to separate the lead that may be entangled amongst it. As a considerable volatilisation of lead takes place in these hearths, they must be connected with proper arrangements for condensation.

The charge for this furnace is composed of 1,000 parts of reverberatory slags (consisting chiefly of lime, peroxide of iron, oxide of lead, a little sulphide of lead, and sulphates of lead and lime), with 200 parts of coal ashes (silica, alumina, peroxide of iron, and mechanically mixed coal), 132 parts of aluminous reverberatory furnace bottoms, and a variable quantity, usually 50 parts, of rich hearth slags. The lime of the reverberatory slags becomes scorified by the silica and alumina of the coal ash and furnace bottoms.

About six hours after having kindled the coke on the hearth the temperature will be high enough to begin the smelting, and the next day the normal charge may be given. The slag mixture is piled up towards the back wall of the furnace, and coke towards the front wall. Owing to the furnace being so low it is difficult to obtain a uniform nose. During the operation the sulphates of lead and lime are decomposed by silica, and the resulting silicate of lead by peroxide of iron and lime; the oxides are reduced by coal, and any sulphide of lead which may be present or formed by the reduction of sulphate of lead is decomposed, partly by the iron walls of the furnace, and partly by the reaction of oxide of lead. The following products are obtained by this process:—The reduced lead trickles through the porous coke rubbish and flows over the sloped hearth into the fore hearth, and thence into the iron pot. The slags which flow out at the front contain about 5 or 6 per cent of scorified lead, and more or less is mechanically intermixed with lead, as the continued movement does not allow a complete separation of lead and slag. The rapid melting and the small height of the furnace also cause the volatilisation of much lead.

The following products are obtained by this process:—

1. **Slag Lead**, which is much less pure than that extracted direct from the ore, and requires to be refined.

2. **Smoke**, collected in the condensing flues. This is moulded into the form of bricks and slowly dried, then smelted in hearth furnaces with coal-ash like the slags.

From 65 tons of such bricks 30 to 33 tons of pure lead, poor in silver, are smelted in three weeks. The yield is about  $\frac{1}{2}$  of the lead volatilised in the slag melting process.

The cost of condensing and smelting the smoke does not exceed £5 2s. 6d. per ton of lead produced from it.

3. **Slags**, poor and rich. The rich slags, which contain a great deal of oxide of iron, are allowed to run into the floor of the smelting works; they are broken into pieces about the size of the fist, and are mixed up with the charges for the hearth furnace. The poor slags are either run into water and separated as before described, or they are run into iron pots, and smelted again in Castilian furnaces. The Castilian furnace is a cylindrical hearth furnace, furnished with three tuyeres, and in other respects similar to the hearth furnace. By using coke a higher temperature may be maintained in these furnaces than in the common hearth furnaces, and more lead is therefore extracted. This furnace is described at page 46.

At Deebank, about 3 tons of slag, or 4 tons of the mixture, are smelted in 24 hours, with  $\frac{1}{2}$  ton of coke, yielding about 1 ton of lead, and slags containing 5 or 6 per cent of lead. In fourteen days about 48 tons of slag are smelted with 13.50 tons of coke. The expense of smelting the slags amounts at Deebank to 11s. 6 $\frac{1}{2}$ d. for 1 ton, requiring 0.280 ton of coke and 0.164 ton of coal, and yielding 0.350 ton of lead and 0.050 of smoke. The application of hot blast in the smelting of slags has effected a considerable saving of fuel, and gives a larger yield.

At the Panther\* lead works, near Bristol, 320 cwts. of lead slags, containing 37 per cent of lead, are produced each week, consuming 104 cwts. of coke, and yielding 116 cwts. of slag lead, with  $\frac{1}{4}$  oz. of silver; the whole loss of lead therefore

\* TUNNER, Leoben, Jahrb., 1852, [iii., 154. KARSTEN'S Arch., 2 R., Bd. 25. B. u. h. Ztg., 1853, p. 909. B. u. h. Ztg., 1859, p. 388.



amounts only to  $2\frac{1}{2}$  cwts. In the course of six months 667 tons of ore, containing 77 per cent of lead, were smelted, yielding 30 tons of smoke, containing 32 per cent of lead.

Instead of being fed by a cold blast, these hearth furnaces are sometimes supplied with hot air.\* When using the cold blast, it is often found difficult to proportion the quantity of slag or other substance operated on, so as to prevent the nose, or cone of slag which forms at the end of the tuyere, growing too long, and interfering with the operation. When the substance operated on is poor in metal, and very frequently refractory, the smelter is obliged to break off this cone, or introduce some more fusible substance to cause it to melt. By the introduction of hot air this inconvenience is removed, since by increasing or lowering the temperature of the blast, the nose may be allowed to lengthen or shorten, according as the nature of the slags may require. The temperature found to answer best is from 250° to 300°F.; when it is heated much higher it is found impossible to form a nose long enough to convey the blast to the front of the hearth, and, therefore, the back, which is expensive to rebuild, is quickly destroyed.

The advantage to be derived from the use of the hot blast will be made evident by the results of two experiments which were tried some years since.

Twenty-eight tons of slag, smelted with cold blast, consumed 392 cubic feet of air per minute; the expense was—

	£	s.	d.
For labour . . . . .	3	7	8
„ coke, 7 tons at 24s. 6d. . . . .	8	11	6
Total . . . . .	£11	19	2

Thirty-five tons of similar slag smelted with hot blast, consumed 300 cubic feet of air per minute; the cost was—

	£	s.	d.
For labour . . . . .	3	7	8
„ coke, 5 tons 17 cwts. at 24s. 6d. . . . .	7	3	4
„ turf for heating air, 11 loads at 1s. 8d. . . . .	0	18	4
Total . . . . .	£11	9	4

\* Dr. URE's Dictionary of Arts, vol. ii., p. 820.



From this it is seen that with one-fourth less air, one-fourth more slag was smelted per week, and a saving of nearly 10s. was effected.

To lessen the loss of lead by volatilisation, and to save fuel and produce a slag sufficiently poor to be thrown aside, the slag hearth has, of later years, been gradually superseded by the Castilian furnace.\*

This furnace, although first employed in Spain, was invented by an Englishman, Mr. W. Goundry, who was employed in the reduction of rich slags in the neighbourhood of Carthage.

The furnace is circular, usually about 2 feet 6 inches in diameter, and is constructed of the best fire-bricks, so moulded as to fit together and allow all the joints to follow the radii of the circle described by the brickwork. Its usual height is 8 feet 6 inches, and the thickness of the masonry invariably 9 inches. The breast is formed by a semicircular plate of cast iron, furnished with a lip to allow the slag to run off, and has a longitudinal slot, in which is placed the tapping hole.

On the top of the cylinder of brickwork a box-shaped covering of masonry is supported by cast-iron frame work, resting on four pillars, and in this is placed the door for feeding the furnace, and the outlet by which the various products of combustion escape to the flues. The lower part of this hood is fitted closely to the body of the furnace, whilst its top is closed by an arch of  $4\frac{1}{2}$  inch brickwork laid in fire-clay. The bottom is composed of a mixture of coke dust and fire-clay, slightly moistened, and well beaten to the height of the breast-pan, which stands nearly three feet above the level of the floor. Above the breast-pan is an arch, so turned as to form a sort of niche, 18 inches in width, and rather more than 2 feet in height.

When the bottom has been solidly beaten up to the required height, it is hollowed out so as to form an internal cavity, communicating freely with the breast-pan, which is filled with the same material, and subsequently hollowed out to a depth slightly below the level of the internal cavity.

\* B. u. h. Ztg., 1859, p. 388—419; 1862, p. 243. Dr. URE's Dictionary of Arts, ii., 820.

The blast is supplied by three water tuyeres, 3 inches in diameter at the smaller end,  $5\frac{1}{2}$  inches at the larger, and 10 inches in length. Into these the nozzles are introduced, by which a current of air is supplied by means of a fan or ventilator, making about 800 revolutions per minute. The blast may be conveniently conducted to the nozzles though brick channels built beneath the floor of the smelting house.

Ores treated in this furnace ought never to contain more than 30 per cent of metal, and when richer, must be reduced by the addition of slags or other fluxes. In charging this apparatus the coke and ore are supplied stratum over stratum, and care must be taken to dispose the coke so as not to heat the brickwork of the furnace too violently. In order to allow the slags produced to escape freely into the breast-pan, a brick is left out of the front of the furnace at the height of the fore hearth, which is kept covered by a layer of coke dust or cinders, in order to prevent the cooling of the slag. From the breast-pan the slags constantly flow off through a spout into cast-iron waggons, where they consolidate into masses having the form of truncated pyramids, their larger base being about 2 feet square. As soon as a sufficient amount of lead has accumulated in the bottom of the furnace, it is led off into a lead pot at the side, by removing the slag stopper of the tap-hole situated in the slot of the breast-pan, and after having been properly skimmed it is ladled into moulds. Any copper contained in the ore will be found in the form of a matt floating on the surface of the lead bath; this, when sufficiently solidified, is removed, and after roasting is worked up for the copper it contains. The waggons in which the liquid slag runs off are frequently mounted on small railways.

In working these furnaces, care must be taken to prevent flame from appearing at the tunnel head, since, so long as the slags are sufficiently liquid, the cooler the furnace is kept the less will be the loss of metal through volatilisation. In addition to the greatest attention being paid to the working of the furnace, all establishments in which this furnace is employed should be provided with long and capacious flues, in which the condensation of the smoke may take place

previous to its arriving at the chimney shaft. These flues should be at least three feet wide and six feet high, so as to admit of cleaning, and are often of several thousand yards in length. The value of the smoke so condensed amounts to many hundreds, and in some instances thousands, of pounds yearly.

In order to be advantageously worked in these furnaces, the ores should be first roasted, and subsequently agglomerated into masses, which, after being broken into fragments of about the size of the fist, and mixed with the various fluxes, are charged as before described.

In an establishment in which the average assay produce of the roasted ore for lead is 43, the furnace yield is 39, and the weight of coke employed to effect the reduction, 22 per cent of the weight of the roasted ore operated on. The mixture charged into the furnace, in this instance, is composed of 100 parts of roasted ore, 42 parts of slag from a previous operation, 8 parts of scrap iron, and 7 parts of limestone. Each furnace works off about 7 tons of roasted ore in the course of 24 hours; the weight of slag run off is about double that of the lead obtained, and the lead removed from the surface of the pan is nearly 5 per cent of the lead produced. The ores treated in the establishment consist of galena much mixed with spathose ore, and are therefore somewhat refractory.

Figs. 13, 14, 15, and 16 represent respectively a vertical section, an elevation, a ground plan, and a horizontal section of a Castilian furnace. The section (Fig. 16), is on the line  $xy$  (Fig 14.) A is the body of the furnace, B the bottom, composed of a mixture of coke dust and fire-clay; C C C, the tuyeres; D, the rectangular covering of masonry; E E E E, cast iron pillars; F, the breast-pan; G, the slot for the tapping hole; H, lip of breast-pan; I, feeding door; K, flue hole; P Q, ground line.

During the years 1848 to 1857, 641,101 tons of lead were produced in Great Britain from 907,486 tons of lead ores, making an annual average of 64110·1 tons of lead out of 90748·6 tons of ore, equal to 70·6 per cent. Of this quantity, 69·9 per cent were produced in England, 21·7 per cent in

Wales, 3·0 per cent in Ireland, 2·5 per cent in Scotland, and 2·1 per cent in the Isle of Man.

FIG. 13.

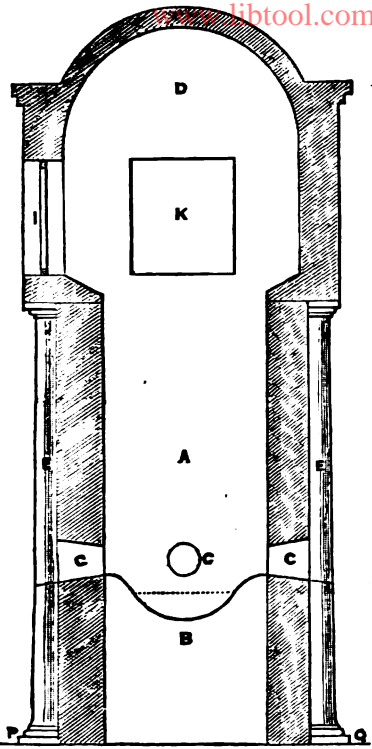

FIG. 14.

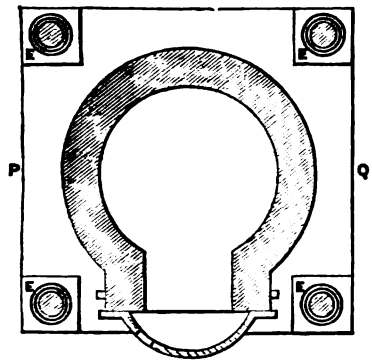
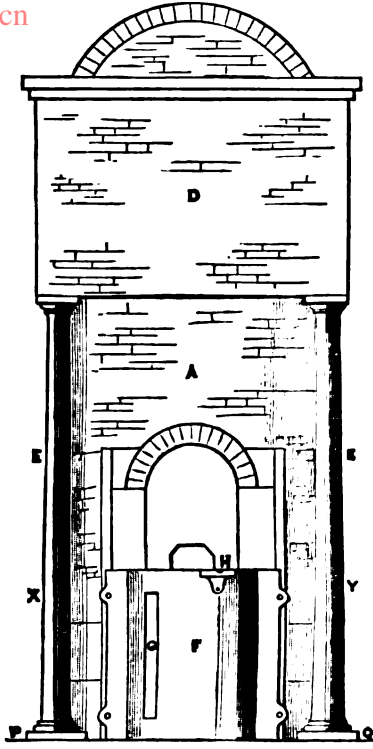

FIG. 15.

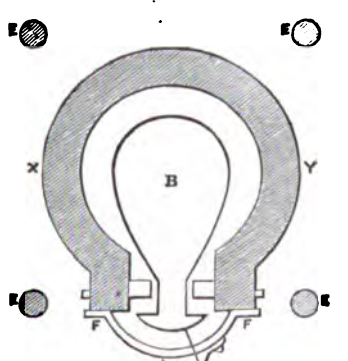

FIG. 16.

E

According to "Hunt's Mineral Statistics" for 1864, there were produced in Great Britain in that year, from 94,433 tons, 1 cwt. of lead ore, 67,081 tons, 9 cwts. of lead, and 641,088 ounces of silver.

### **Modifications of the Normal English Reverberatory Process.**

The English process, as already described, must undergo some modifications if the ores employed are associated with foreign substances, the chemical reactions of which are either advantageous, as in the case of white lead ore; or injurious, when earths and sulphides are present, which tend to lower the amount of lead in the ore; or if local circumstances render it advisable to adhere to the reverberatory process. This is the case in the lead works of Derbyshire and Cornwall.

In Derbyshire,\* galena contaminated with baryta is worked, and in order to avoid great loss, the ores are not so closely dressed as those of Flintshire. These ores also contain a large amount of carbonate of lead, which considerably shortens the roasting process, and enables so much lead to be extracted in the first period, and at so low a temperature, that the slags keep in a pasty state, and do not run into the sump. The slags, which are formed in considerable quantity, are afterwards spread outside the sump, mixed with fluor spar and lime, and again exposed to a strong heat. The galena in this way becomes decomposed by the lime, and the baryta is liquefied by the action of the fluor spar. The fused slags are run out of the furnace by a side door, and if they contain no more than from 5 to 8 per cent of lead, are thrown aside; the crude lead is tapped off, and the oxysulphide which covers the crude metal is treated, as in Flintshire, with lime, and, lastly, with coal slack, for the extraction of its lead. The resulting residues are again worked in a slag hearth. The quantity of slag which has to be worked over again is rendered much less by this modification than in Flintshire, where it is necessary to work all the slags a second time. If the ores contain 70 per cent of lead, the

\* Rivot. c. i., p. 346. B. u. h. Ztg, 1862, p. 243.

quantity extracted in the first period amounts to as much as 60 per cent.

The operations of this process are as follows:—

16 cwts. of ore are roasted for about two hours, till the temperature rises to a red heat, the reactions being started by stronger firing with closed doors; they are roasted for about one hour, and then turned over, so that after a lapse of three and a half hours from the commencement of the process the furnace has attained a bright red heat, and 60 per cent of lead is produced. 1 cwt. of fluor spar and  $2\frac{1}{2}$  cwts. of lime are then mixed with the spread-out slags, and the heat is again raised, and the fused slags removed, after the reduction of lead has ceased. Finally, the oxysulphide which covers the metal bath is decomposed by lime and coal at an increased temperature, and after six hours' work the residues are removed.

In twenty-four hours 5·20 tons of ore are worked, with from 2 to 2·10 tons of coal. One ton of ore, containing 0·7 ton of lead, yields 0·630 ton of crude lead containing nearly all the silver, 0·300 ton of valueless slags (containing 0·025 ton of lead), and 0·100 ton of residue containing from 0·035 to 0·036 ton of lead, which is worked up in the slag hearth. The total yield of 1 ton of ore amounts to about 0·666 ton of lead, leaving a loss of 0·034 ton. Supposing the dry assay to give a result which is 5 per cent too low, the real loss in the above process amounts to 10 per cent, a result which is favourable, and may be attributed to the white lead ore contained in the galena. If the ores in Flintshire contained the same amount of white lead ore, they would give still more favourable results. The residues yield in the slag hearth 33 to 34 per cent of somewhat impure lead, besides some lead fume, &c.

At the lead works at Par,\* in Cornwall, besides the Cornish galena, containing 60 to 75 per cent of lead, there are worked ores in the form of slime, rich in silver, but containing only 16 per cent of lead, and galena associated with copper pyrites, containing from 20 to 30 per cent of lead. These

\* B. u. h. Ztg., 1862, p. 244.

are mixed in such proportion that the charge will contain 50 per cent of lead and about 30 ounces of silver per ton. Charges of 2 tons are roasted for twenty hours in a separate furnace, with 1 ton of coal, and at a gradually increasing temperature. During the roasting, lime is repeatedly added, and the mass turned over every quarter or half hour. These two-ton charges are then heated in a reverberatory furnace for 3 hours till they become nearly liquid, and coal rubbish or saw-dust, and afterwards lime, are mixed up with it until the mass gets pasty. As soon as the mixture is properly worked up at a greater heat, fluor spar and metallic iron are added, the whole melted into the sump, and its contents made to run into an outside basin, from which the slag will flow out on to the floor of the melting houses. These slags are, in all cases, thrown away. The resulting copper-lead matt which covers the surface of the raw lead is then treated in a reverberatory furnace with common salt and iron, the result being crude lead and a copper matt, containing 8 to 12 per cent of copper. The latter is removed and sold to the Welsh copper smelters. The very impure cupriferos lead is then stirred with wood rubbish, and the scum worked again. In 24 hours three charges of 2 tons each are smelted with  $2\frac{1}{2}$  tons of coal.

By longer roasting with lime the sulphides are in great part transformed into oxides, which, at a higher temperature, decompose the remaining sulphides, the oxide of lead decomposing the sulphide of lead, and the oxide of copper the sulphide of copper. The resulting metallic copper again becomes sulphuretted by the remaining sulphur, and partially enters into combination with the metallic lead liberated at the same time. The oxysulphide is decomposed by treatment with coal, lime, and iron; the latter is added also for the purpose of forming a matt for collecting the copper, consisting of sulphides of iron, copper, and lead. In order to enable a separation to take place in the order of their respective densities, the whole mass is rendered more fusible by an addition of fluor spar.

In the interior of Spain\* the Carinthian process is adopted,

\* B. u. h. Ztg., 1862, p. 53.

but the English process is used on the coasts, as cheap coal from England and Asturia is to be obtained there.

The reverberatory furnaces in use are similar in construction to those of Flintshire (page 39).

4 charges of about 20 cwts. each are worked every 24 hours with 42 cwts. of coal; the average product is 56 cwts. of crude lead, equal to 58 to 62 per cent. In consequence of the addition of lime, the resulting slags are poorer than those from Spanish furnaces, but, on the other hand, the resulting lead is also more impure than that from Spanish furnaces, on account of the higher temperature used; the production is, however, greater. The slags contain from 16 to 20 per cent of lead, and yield from 12 to 15 per cent in small cupola furnaces.

The loss of lead by volatilisation (5 or 6 per cent) is lessened by extensive condensation flues. The deposited fume, after being mixed with lime and pressed into the form of bricks, and containing from 30 to 40 per cent of lead, is also smelted in cupola furnaces.

The residues are worked in low cupola furnaces. From 120 to 150 cwts. of residues, mixed with from 25 to 30 cwts. of old slags, are smelted every 24 hours, with the consumption of 20 to 24 cwts. of coke, or 35 to 40 cwts. of charcoal; yielding from 17 to 20 cwts. of somewhat hard lead. The yield, therefore, amounts to from 15 to 18 per cent, and the consumption of coke is  $1\frac{1}{4}$  parts to 1 of metal. The smeltings in succession in one furnace occupy about 6 weeks.

The total smelting expenses for ore and residues in Spanish furnaces amount, for every 2 cwts. of ore, to 3s., and for 2 cwts. of reduced metal, to 13s. In English furnaces these expenses are respectively 3s. 6d. and 13s. The residues are sometimes also worked in air cupola furnaces.

The increasing scarcity of charcoal in the Hartz led to determined attempts being made to import the English method of smelting lead ores, as practised in Flintshire. But, as a slight admixture of quartz prevents the complete extraction of lead, and as the ores of the Hartz often con-



tain as much as 17 per cent of silica and alumina, all these trials were unsuccessful.

### www.c. THE FRENCH REVERBERATORY PROCESS.

The theory of this process is as follows :—

Galena, when calcined at a long continued and gradually raised temperature, is for the greater part transformed into sulphate of lead and a little oxide of lead. If the roasting is interrupted at that period at which some undecomposed galena is present along with the sulphate of lead, and the temperature then raised to near the fusing point, the constituents of the mass will decompose each other in such a way that oxide of lead is formed, together with sulphurous acid and a small quantity of metallic lead. The resulting oxide of lead is then reduced by treatment with coal. The following equations represent the reactions :—

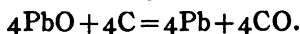
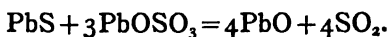

The remaining sulphate of lead is also decomposed by the coal. According to Gay Lussac† an excess of coal transforms it into sulphide of lead with evolution of carbonic acid. If equal equivalents of carbon and sulphate of lead act upon each other at a low red heat, carbonic acid is evolved, and only half the sulphate of lead is transformed into sulphide.



At a higher temperature the sulphate of lead reacts upon sulphide of lead, forming metallic lead and sulphuric acid. If for 2 equivalents of sulphate of lead only 1 equivalent of coal is used at a lower temperature,  $\frac{1}{2}$  an equivalent of sulphide of lead is formed in the first instance, thus—



which at an increased temperature becomes changed by the  $1\frac{1}{2}$  equivalents of sulphate of lead into sulphurous acid and oxide of lead, thus—

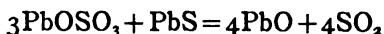

\* ERDM. J., f. p. Ch., xi., 68.

These chemical facts are the foundation of the French reduction process in reverberatory furnaces.

More impure and siliceous lead ores may be worked by this method than by the English process, as the temperature may be kept so low as not to cause scorification. With regard to the yield of metal, the process is more unfavourable when the quartz is above 5 per cent, on account of a scorification which then takes place at the lower temperature employed. A certain amount of pyrites, on the one hand, augments the residue, but, on the other hand, it assists the formation of sulphate of lead; zinc blende has a favourable influence, as the oxide of zinc formed during the roasting enters into combination with the silica. Blende also acts mechanically by stiffening the mass and facilitating the roasting. The production in French furnaces is smaller than in English furnaces, and the dimensions are less. The form is also somewhat modified, and the hearth furnished with a sump.

At Poullaouen\* a mixture is worked consisting of galena poor in silver, raised in that neighbourhood, † and ores from Huëlgoet ‡ rich in silver, containing on the average 54 per cent of lead and  $2\frac{1}{2}$  ounces of silver in a cwt. These are also accompanied by pyrites, argentiferous zinc blende, || and quartz.

The reverberatory furnaces represented by Figs. 17 and 18 are either heated with coal or with wood; in the former case the grate is raised higher, and the fire-bridge is made smaller. The furnace is first furnished with a clay hearth, and after this has been gradually dried for about 2 months, and carefully warmed, a charge of 10 cwts. is given for the purpose of saturating the hearth with sulphide of lead. After

\* BEAUMIER ET GALLOIS, Journ. des Mines, xvi., 193; KARST. Arch., I. R., vi., 161. Journal des Mines, xiii., 272; xx., 419. Ann. d. Min., 1 sér., iii., 549; vii., 21; 3 sér., xviii., 161; 4 sér., iv., 331. ERD., J., f. ök. u. techn. Ch., xiii., 197. KERL, B. u. h. Ztg., 1854, p. 178. KUTCHER, *ibid*, 1859, p. 341. RIVOT, c. I., 611, 620, 630.

† BERTHIER, *Analyt. met. Ch.*, ii., 629. COTTA, *Erzlagertstätten*, ii., 429, 685, 687.

‡ DAMOUR, in *Ann. d. Min.*, 3 sér., xvii., 19. COTTA, *Erzlagertstätten*, ii., 429.

|| B. u. h. Ztg., 1862, p. 9.

FIG. 17.

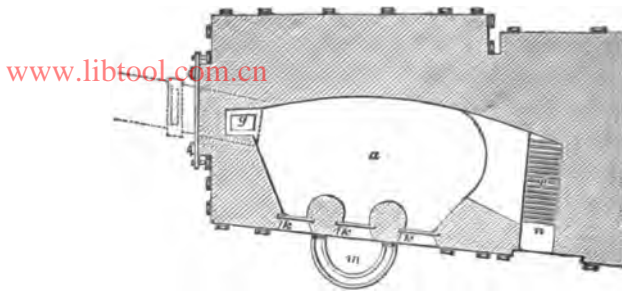
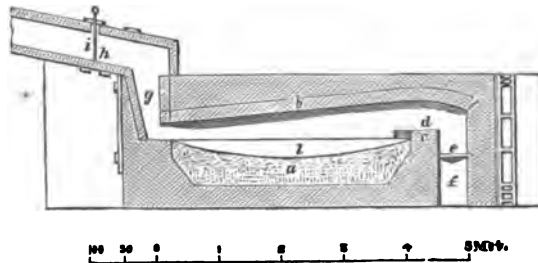

FIG. 18.



24 hours that which has not been soaked into the hearth is removed, and higher charges are added, which yield more and more lead, until with the 9th charge the furnace has obtained the full quantity, amounting to 26 cwt. With the 13th to the 15th charge the yield of crude lead begins to be regular, and the furnace is now in the proper state for production. Each charging takes about half an hour, two-thirds of the ore being put before the fire-bridge and one-third at the back. In about  $1\frac{1}{2}$  hours a crust of sulphate of lead,  $1\frac{1}{2}$  to 2 inches in thickness, is formed, indicating the beginning of the *first period* of the roasting. On lowering the temperature to dull redness, the *second period*, which is the real roasting, begins; when this takes place the crust is broken up and mixed with the mass beneath, which is now continually turned over.

After a crust has again been formed and mixed up with the mass, to facilitate the formation of sulphate of lead, the charge commences to cake together, and drops of lead

appear, formed, as in the Carinthian process, by the reaction of the sulphide of lead upon the sulphate. This completes the second or roasting period, which occupies about 4 hours. The *third period*, the production of crude lead, is now commenced by throwing in pieces of wood, reducing the oxide to metallic lead, which flows into the sump. If necessary, the roasting mass may be previously rendered more pasty by mixing it up with coal slack. The contents of the furnace are now thoroughly worked up with wood by the different working doors, till after a lapse of from 4 to 5 hours the sump is filled up with lead. The latter is then tapped off, and before running it into moulds is purified by stirring it up with pieces of wood. The temperature is now raised again, and the mass is stirred up and mixed with wood, until after a lapse of  $1\frac{1}{2}$  hours the crude lead is tapped a second time. The operation is then repeated a third time. Lastly, the ore which had been put at the back is drawn to the front of the fire-bridge; the temperature is then raised, and the last yield of lead results. In 16 hours from the beginning of the operation, those residues which are not required for the repair of the hearth are removed; they contain from 20 to 30 per cent of lead and  $\frac{1}{4}$ th oz. of silver, and are smelted in a small cupola furnace 5 feet in height, or in a reverberatory furnace, together with other lead products, 10 per cent of iron, and argentiferous iron ore and quartz from Huëlgoet, producing crude lead with about 8 ounces of silver. 84 cwts. of such mixture are worked in a reverberatory furnace in 24 hours. The cupola furnace produces less lead, but gives poorer slags, and occasions less loss by volatilisation.

The lead fume containing from 38 to 40 per cent of lead and  $\frac{1}{4}$  oz. of silver, is treated in reverberatory furnaces of the ordinary construction; the 4 hours' roasting period is, however, not required. 16 cwts. of fume are worked in 12 hours. From 15,000 cwts. of ore, which are usually treated in a reverberatory furnace, there are obtained on an average 225 cwts., or 1 to 2 per cent of fume.

The hearth of the reverberatory furnace is removed every  $1\frac{1}{2}$  years, and added in mixture to the ore smelting in cupola furnaces.

The total loss of lead varies according to the weather (which has an influence on the process), the quality of the fuel &c. between 3·8 and 6·6 per cent. By reducing the fuel to the weight of charcoal, and supposing a yield of 20 per cent of coal from wood, 1 part in weight of coal is used for every 2 to 3·5 parts of ore. The consumption of iron varies between 2·4 and 3 per cent. According to Rivot, 1 ton of ore yields 0·470 ton of crude lead, containing 9 ozs. of silver; and 0·324 ton of residues, containing 0·123 ton of lead and 1·75 ounces of silver. The yield in reverberatory furnaces is 71 per cent of the lead contained in the ore; about 20 per cent remains in the residues, whilst nearly all the silver will be found in the crude lead.

The expense on 1 ton of ore amounts to—

	£	s.	d.
Wages . . . . .	0	1	2·6
Wood (0·8080 ton) . . . . .	0	4	5·7
Coal (0·1850 „) . . . . .	0	5	1·5
Tools (0·0115 „) . . . . .	0	2	8·7
Sundries . . . . .	0	1	2·2
	<hr/>		
	£0	14	8·7

The loss of lead per ton of ore amounts to 0·067 ton, valued at £1 6s. 6d.; the loss of silver, to 0·0123 lb., valued at 1s.; together £1 7s. 6d.

The process at Poullaouen requires more fuel than the English process, on account of the employment of wood and the length of the roasting period. It also produces less lead in a metallic state, and the loss of metal is greater.

The composition of lead slag from Poullaouen resulting from galena containing blende is—

Silica . . . . .	24·0
Oxide of lead . . . . .	26·5
Sulphide of lead . . . . .	5·0
Sulphate of lead . . . . .	3·0
Peroxide of iron . . . . .	14·0
Oxide of zinc . . . . .	27·0
	<hr/>
	99·5

At Pesey,\* in Savoy, the French process is employed, but the hearth is of larger dimensions, and furnished with a partition wall having a communication between the two partitions. The reduction takes place in the nearer part, situated close to the fire-bridge, and the roasting goes on in the back part; by this arrangement a larger production is gained, and there is less loss of lead, and a smaller consumption of fuel.

Efforts have been made to introduce this process at the Clausthal lead works,† but without success, on account of the large amount of silica contained in the ores of the Hartz.

At Corfali, in Belgium, charges of 26 cwts. of calcareous galena, containing pyrites and blende, are worked in 16 hours; 6 hours for roasting, and the remaining 10 hours for the reduction of the oxide of lead by stirring it up with wood.  $14\frac{1}{2}$  cubic feet of coal and  $51\frac{1}{2}$  cubic feet of wood are used in this process; the yield of lead is from 50 to 60 per cent. The residues of this process are worked in a reverberatory furnace with an inclined hearth, and with the addition of cast iron. To assist the formation of slag 1 cwt. of limestone is spread out upon the sole of the furnace, and 5 cwts. of residues, 5 cwts. of poor earthy ores, and  $1\frac{1}{4}$  cwts. of iron are placed on it. After 5 hours the resulting lead is tapped off, and the furnace charged again. The consumption of coal for one charge amounts to  $8\frac{1}{2}$  cubic feet.

In 31 days, 760 cwts. of lead (= 67·62 per cent), and 170 cwts. of residues containing 51 cwts. of lead, were produced from 1,112 cwts. of lead ore, giving a total yield of 72 per cent. 617 cubic feet of coal and 3,410 cubic feet of wood were required for this result.

In Vienne furnaces 540 cwts. of residues and 320 cwts. of poor ore (galena) were smelted in 20 days, consuming 900 cubic feet of coal, 106 cwts. of scrap iron, and 35 cwts. of wrought iron, and producing 238 cwts. (= 28·65 per cent) of

\* DUMAS, *angew. Ch.*, iv., 240. LELIVEC, *Journ. d. Min.*, xx, 419. BERTHIER, *Ann. d. Min.*, 1 sér., iii., 549. REPLAT, *Ann. des Min.*, 3 sér., xviii., 161; 4 sér., iv., 331. BERTHIER, *Met. analyt. Chem.*, ii., 629, 647. CORTA, *Erzlagerstätten*, ii., 331.

† KERL, *Oberharzer Schmelzprocesse*, 1860, p. 581. KERL, *B. u. h. Ztg.*, 1854, p. 217, No. 25.

lead. It is more advantageous to smelt the residue, together with ores and iron refinery cinders, in cupola furnaces, 3·66 metres high above the tuyere.

A mixture consisting of—

20	cwts.	Residues of the reverberatory furnace . . . . .	} containing 39 per cent of lead.
40	„	White lead ore . . . . .	
24	„	Iron refinery cinders	
24	„	Furnace ends containing 20 per cent of lead	

108 cwts.

was smelted with  $8\frac{1}{2}$  to 9 per cent of coke. The loss of lead amounted to  $2\frac{1}{2}$  per cent,  $\frac{1}{2}$  per cent of which was contained in the slags, and 2 per cent was collected in the condensing chambers.

The ores used in the lead works at Bleiberg and Binsfeldhammer, in the neighbourhood of Stolberg, near Aix-la-Chapelle, are either free from copper, or contain only traces of it; but they have more or less antimony, which makes it necessary to refine the raw lead previous to its treatment by Pattinson's process.

The galena occurring at the lead works at Bleiberg\* consists chiefly of very pure ore with small quantities of associated minerals, namely, quartz (from  $\frac{1}{4}$  to 1 per cent), blende, pyrites, and, in rare cases, limestone. It contains 82 per cent of lead,  $\frac{3}{4}$  per cent of antimony, and  $4\frac{1}{2}$  ounces of silver to the ton.

Reverberatory furnaces with a fire-place on each side are used for smelting the ore. They are represented by Figs. 19, 20,

FIG. 19.

FIG. 20.

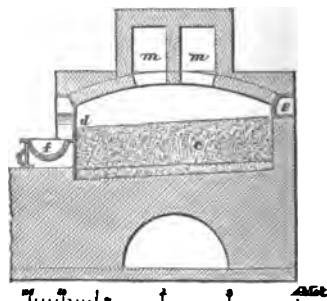
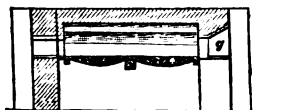

\* VON COTTA'S Erzlagerstätten, ii, 137.

FIG. 21.

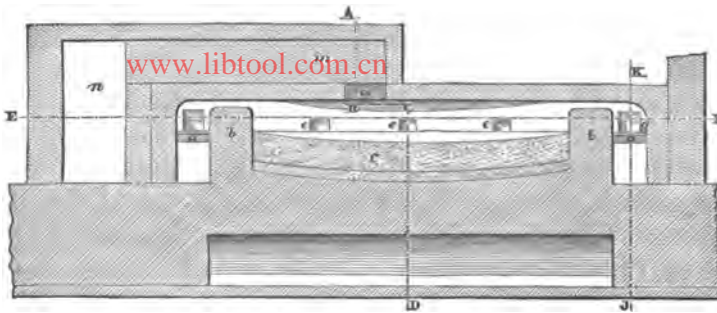
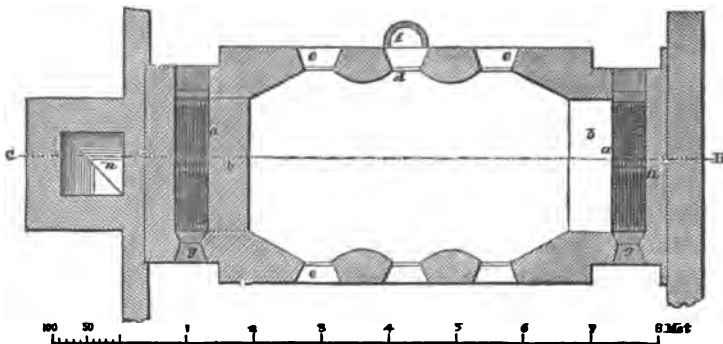

FIG. 22.



21, and 22. *a* is the grate; *b*, the fire bridge; *c*, hearth; *d*, lead sump; *e*, working doors; *f*, outside basin for receiving the metal; *g*, opening for charging the fuel; *m*, flues; *n*, chimney. The hearth slopes from the fire-bridge towards the middle, where it forms a sump, which likewise slopes from one broad side of the furnace to the other, and communicates with the outside basin. The two working doors at the extremities of each long side of the furnace are used for manipulating on the hearth, which is formed either of slags got from smelting the residues of the reverberatory process, or of other slags, from  $1\frac{1}{2}$  to 2 feet thick, smelted upon a sole of bricks; an addition of lime is made to stiffen the mass and render it more refractory.

As soon as the furnace is properly cooled, the workmen charge it with two tons of ore, which occupies about 30 minutes; the ore is then heated from  $\frac{3}{4}$  of an hour to 1 hour



until red hot, whilst the working doors are closed ; it is then turned over with iron rabbles every half-hour, for 7 or 8 minutes, both workmen commencing at opposite working doors, and working on to the middle of the furnace. In about 5 hours from the commencement, the roasting mass having become fat under the influence of the gradually increased temperature, begins to smoke, and easily fusible alloys of antimony and lead flow out in small quantity from the sump into the outside basin, before the real reaction of the sulphate of lead upon the sulphide commences. As soon as a sufficient quantity of that alloy is produced, glowing coal and coal slack are thrown into the basin and stirred in it, causing a separation of slag from the lead alloy, which is removed and put back into the furnaces.

When the roasting mass upon the hearth begins to become pasty, some shovels-full of coal slack are mixed up with it in order to give it a stiffer consistence. About 8 hours after charging, a copious extraction of lead begins at the higher temperature, but less slag is separated in the outside basin ; this slag is crumbly—from other reasons than the first formed slag—and becomes stiff very quickly : whilst cooling, drops of lead are still running out of it.

After about  $10\frac{1}{2}$  or 11 hours the whole process is finished, and from an hour to an hour and a half's time is allowed for cooling the furnace. From the ore containing 82 per cent of lead, about 60 per cent of lead is produced, and this lead contains at first 8 ounces, and later 5 ounces of silver in the ton. The residues often contain as much as 70 per cent of lead, besides a considerable quantity of antimony. The consumption of coal in 24 hours amounts to 53 cubic feet, and the loss of lead is about 5 or 6 per cent ; this, however, is notably lessened by working up the contents of the very extensive condensation chambers.

**Smelting the Residues.**—The raw lead is refined by Pattinson's process. The residues are worked in cupola furnaces about  $5\frac{1}{2}$  metres high, having a sump inside the furnace for collecting the metal ; they are mixed with 60 per cent of iron refinery cinders, 18 per cent of lime and broken bricks, and 6 per cent of impure slags, and are smelted

with 14 per cent of coke. In 24 hours about 180 cwts. of residues are worked, and at the bottom of the furnaces little or no deposits of iron are obtained during the working of the furnace, which continues from 5 to 7 weeks. The very hard lead which results is refined according to Pattinson's process; it contains from 2 to  $2\frac{1}{2}$  ounces of silver in the ton. The small quantity of resulting matt, with from 5 to 10 per cent of lead, is, after crushing, roasted in reverberatory furnaces, and added to the smeltings in cupola furnaces. The resulting basic slag, which runs into iron pots, contains but 0.3 to 0.5, or at the most 1 per cent of lead, and is thrown aside.

At the lead works at Bindfeldhammer, calcareous galena, containing 70 per cent of lead and about 19 ozs. of silver in the ton, are worked in reverberatory furnaces; poorer and less pure ores associated with blende, pyrites, calcareous spar, quartz, copper pyrites, sparry iron ore, &c., are roasted and worked together in cupola furnaces with the residues of the reverberatory process. The reverberatory process is similar to that used at Bleiberg; smaller furnaces are used, having only one fire-place and a capacity for only one ton of mixture; but they consume in 24 hours 53 cubic feet of coal. A charge is completed every 9 hours. The furnace is charged whilst the temperature is still very high from the last operation; the temperature is kept up till the ore, which is frequently turned over, has become thoroughly glowing, when it is lowered. The roasting occupies about  $5\frac{1}{2}$  hours. The slags which at the former charge had run out of the furnace together with the lead, and which contain some small coke and coal, are now mixed up with the roasting mass, and the temperature is raised so as to allow the greater part of the lead to be extracted and to flow into the sump. During this period the roasting mass is turned over about once every  $\frac{3}{4}$  of an hour. After 8 hours it is turned for the last time, the residues are removed from the furnace, the contents of the sump are stirred up with slacked lime and coal slack, and run into the outer sump. The slags, after being stirred with glowing coal and coal slack, are removed from the lead and added to the next charge.

From the 70 per cent of lead contained in the ore, about

40 are obtained. The crude lead, which contains from 20 to 30 ounces of silver in the ton, is refined by Pattinson's process; the scum resulting from the refining is added to the ore mixture, or it is worked together with residues with a view to the production of hard lead. The residues of the reverberatory process, containing from 30 to 40 per cent of lead, are mixed with roasted ores of the second quality, and 100 parts are smelted with 60 per cent of iron refinery cinders, 15 per cent of lime, and 20 per cent of coke, as at Bleiberg. In smelting the residues the oxide of antimony bears an essential part, forming with oxide of lead a combination only to be decomposed by coal at a very high temperature. This behaviour is advantageous, as it causes the production of a reverberatory lead poor in antimony, and a residue lead rich in antimony. In the same way the separation of the silver in the two sorts of lead is favourable.

The siliceous and impure ores are roasted in double reverberatory furnaces. The two hearths of the furnace have each 2 divisions, and a charge of 2 tons are roasted on each of these divisions for 8 hours, so that each charge remains in the furnace for 32 hours. Thus the furnace roasts in 24 hours 6 tons of ore with a consumption of 17 cubic feet of coal.

The processes adopted in these two lead works, are based on a combination of the Carinthian and French processes, but principally the Carinthian.

In several lead works situated near the mouths of the Rhone in France,\* the process of Poullaouen is in use, chiefly for the ores from Sardinia and Spain, which contain from 60 to 80 per cent of lead, and are associated with calcareous and barytic gangue, and contain very little blende and silica.

At Bottino,† in Tuscany, rich ores containing at least 55 per cent of lead are worked in double furnaces.

\* SIMONIN, Bull. de la Société de l'Industrie Minérale, ii., 412, 413, 429, 430. (With drawings).

† CAILLAUX, Bull. de la Société, &c., ii., 697.

**B. THE FRENCH PRECIPITATION OR VIENNE PROCESS.**

In this process the galena is decomposed in reverberatory furnaces by means of metallic iron. It is carried on at Vienne in the department Poitou, and is adapted for galena, poor in silver and rich in lead, containing so much silica (upwards of 5 per cent), alumina, and other silicates, that it is impossible to work it advantageously in the ordinary way in reverberatory furnaces.

Ores containing less lead and more silver are more economically worked in cupola furnaces when associated with the above-named gangue.

The Vienne process is very simple, but usually so expensive that it is very seldom employed. The process takes place in a reverberatory furnace, made smaller than usual in order to produce a higher temperature; the ore is mixed with metallic iron, and quickly heated before the fire-bridge, till the mass begins to frit. This temperature is kept up for several hours, the pasty mass being worked all the while; when all the iron has disappeared, the temperature is raised until the mass is completely fused, and flows into the sump, where it separates according to the specific gravities. The resulting products are tapped into an outside basin, collecting the lead in it, whilst the matt and slags flow over the edge of the basin on to the sole of the smelting-house. After removing the remaining matt from its surface, the lead is purified, chiefly from mechanically included iron, by stirring it with brush-wood, and is poured into moulds. If necessary for its purification, it is slowly re-melted. Matt and slags, not containing silver, are thrown away.

When galena is heated with iron it becomes decomposed, forming metallic lead and sulphide of iron; the latter forms a combination with a part of undecomposed galena, producing matt. In order to avoid much loss of lead by volatilisation, and a waste of iron tools, too high a temperature should be avoided, and the reaction of the iron assisted by a frequent working of the pasty mass. As this is done in the presence of air, oxide and sulphate of lead are formed, which extract metallic lead by reacting

upon the sulphide of lead; they are also partly decomposed by the direct reaction of iron and sulphide of iron. A complete decomposition of the matt is not possible, as its fluidity hinders its contact with the iron. The liquid slag, rich in oxidised iron and lead, becomes gradually more or less freed from lead by the reaction of the iron tools, and by that of the sulphides.

The process is carried on as quickly as possible, and concluded as soon as the iron in the mixture has disappeared, on account of the great loss of lead and waste of tools occasioned by working at a comparatively high temperature. In order that the lead obtained should not contain too much iron, the addition of iron to ores rich in lead must not exceed 35 per cent. The loss of lead by volatilisation amounts to about 4 per cent of the metal contained in the ore.

Though the loss of lead by volatilisation is greater in cupola furnaces than in reverberatory furnaces, still the former are usually preferable for ores of this kind. The Vienne process requires much fuel, more labour, and many expensive tools; and yields, when working ores containing much silver, matt and slags so argentiferous that they have to be worked again in cupola furnaces. In this case all the advantages of the method, its simplicity of construction and working, the absence of a blast machine, condensation apparatus, &c., which it possesses in preference to the cupola furnace process, are lost. Only occasionally, when a small production is required, and siliceous ores rich in lead and poor in silver have to be worked, and when iron is cheap, the Vienne mode may be adopted.\*

According to Phillips† a saving of iron may be effected if the galena is transformed as completely as possible into oxide and sulphate of lead, by longer roasting at a lower temperature; then the roasting mass, mixed with  $\frac{1}{2}$  per cent of coal slack, and 12 per cent of quartz sand, is quickly heated to a cherry-red heat; by this operation oxide of lead is reduced; but the chief aim is the expulsion of sulphuric acid, partly as

\* KARSTEN'S Archiv., I R. vi., 97.

† RIVOT, Métallurgie du Plomb et de l'Argent, 1860, p. 65.

sulphurous acid, by the reaction of carbon, and partly in form of vapour by the silica, the latter forming a silicate of lead. If the tumefaction of the mass ceases, about 10 per cent of metallic iron is mixed up with it, when silicate of iron will be formed, and the metallic lead separated. If the ores contained silver, the slags resulting from this process will be poorer in silver than those yielded by the Vienne process, as they mostly contain oxidised substances; on the other hand, the yield of lead is less (62 to 65 per cent from ores containing 75 to 76 per cent of lead), and the process requires more time, fuel, and labour. These disadvantages may be balanced, when the price of iron is high, by the smaller consumption of iron, and if the ores are rich in silver, by the more complete extraction of it; but still the results will always be inferior to those obtained in cupola furnaces. Very pure iron ore mixed with coal may be substituted for metallic iron, but ores of the required purity are seldom to be had.

#### Illustrations of the French Precipitation Process.

At Vienne\* from 8 to 20 cwts. of lead ores are worked in from 3 to 6 hours, mixed with from  $1\frac{1}{2}$  to 5 cwts. of iron and iron cinders. Ores containing pyrites are previously roasted and smelted together with iron and coal slack.

In the lead works† on the Rhone, ores containing from 45 to 50 per cent of lead, and 5 to 6 per cent of quartz, are worked.

At St. Louis, 4 tons of ore with 20 per cent of old iron are

FIG. 23.

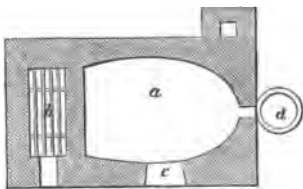
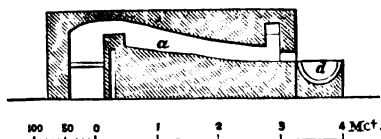

FIG. 24.



\* *Journal des Mines*, xxi., No. 125, p. 381. WEHRLE'S, *Hüttenkunde*, ii., 911, p. 253. KARSTEN'S *Met.*, v., 122. DUMAS, *Angewandte Chemie*, iv., 277.

† SIMONIN, in *Bulletin de la Société de l'Industrie Minérale à St. Etienne*, ii., 429.

worked in 24 hours,  $\frac{1}{2}$  ton of artificial fuel being used for every ton of ore; at Escallette, charges of from 24 to 26 cwts. with 36 or 40 per cent of cast iron or old iron, and sometimes lime and coal, are worked in 8 hours. The ferruginous slags, containing 4 or 5 per cent of lead, are used for desulphurising when smelting in cupola furnaces. The furnace used at the latter works is shown by Figs. 23 and 24. *a* is the hearth; *b*, the grate; *c*, working door; *d*, outside basin for receiving the metal.

### EXTRACTION OF LEAD IN HEARTH FURNACES.

Pure lead ores suitable for the reverberatory process are sometimes smelted in hearth furnaces. A decision between the two modes is chiefly influenced by the price and quality of the fuel to be used; on this account the hearth furnace process is only used in localities where good coal is either wanting or very expensive, and where other kinds of fuel, such as turf, wood, coke, &c., are easily attainable. Hearth furnaces consume less fuel than reverberatory furnaces, allow a quicker operation,—that is to say, a greater production at less wages,—and an interruption of the process at any stage without great loss of temperature. This last fact chiefly recommends the hearth furnace process for smaller smelting works. The lead resulting from impure ores is purer than that produced in reverberatory furnaces. On the other hand, a blast machine and extensive condensation apparatus are required, as, for example, at Alston Moor.

Very pure galena may be worked in hearth furnaces when in a raw state (American hearth process). Impure ores are better previously roasted in reverberatory furnaces (Scotch hearth furnace process), as then an easier smelting and better yield result. By using hot blast a saving of fuel may be effected (American hearth process).

**Theory of the Hearth Process.**—The chemical reactions which form the foundation of the hearth process, are similar to those of the reverberatory process. It includes the extraction of lead by the reaction of the formed oxide and sulphate of lead upon the undecomposed galena, as well as the decom-

position of the formed oxysulphide by lime and coal. The masses under treatment must not fuse during the process.

**THE SCOTCH HEARTH PROCESS.**

The galena is partly roasted in a reverberatory furnace, and the mass converted in a hearth furnace, using cold blast, to a pasty state, when the reaction of the oxides upon the sulphides takes place, and the lead becomes reduced. When the extraction of the lead ceases, the mixture is removed from the furnace, the slags separated, and the oxysulphides formed are replaced in the furnace with an addition of lime; they are then decomposed by the reaction of lime, and of the carbon of the fuel, and the greater part of their lead extracted. The separated slags are worked again for the extraction of the lead, either in slag hearths, in Castilian furnaces, or in some sort of cupola furnace.

Ores with a larger amount of lime may be worked by this process. For example: the process is in use in Cumberland, Northumberland, and Durham,\* and to a great extent in the lead works at Nenthead, in the neighbourhood of Alston Moor. Calcareous galena, containing from 70 to 77 per cent of lead, and some blende, is first roasted for about 8 hours in charges from 9 to 11 cwts. in a reverberatory fur-

FIG. 25.

FIG. 26.

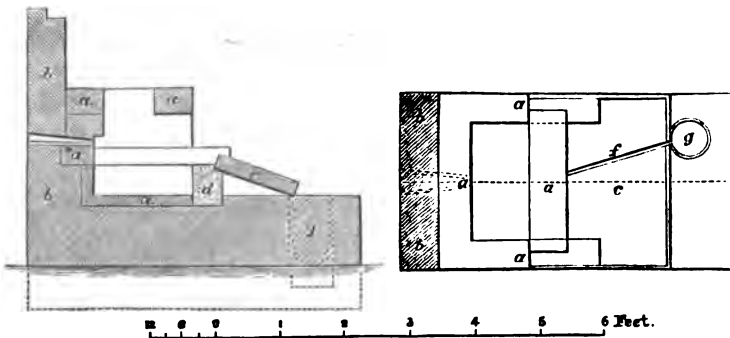

\* WEHRLE's Hüttenkunde, ii., 263. KARST. Met., v. 174. KARST. Arch., I R., vi., 227; xiv., 84, 87, 363. HARTM., Repert. für Bergb. und Hüttenkunde, ii., 380. Ann. des Mines, 1 sér., tom., xii., p. 10, 23, 405. PHILLIPS, Manual of Metallurgy. London, 1852, p. 504. B. u. h. Ztg., 1859, p. 388; 1862, p. 244. Bergegeist, 1861, p. 328.



nace, with a hearth 6 feet 3 inches long and 7 feet broad, and is then treated in four Scotch hearth furnaces standing beneath a single chimney. These hearth furnaces are represented by Figs. 25 and 26, of which Fig. 25 is a vertical section, and Fig. 26 a ground plan. It is formed of cast-iron beams, *a*, which are surrounded by the brick work, *b*. The front part, *d*, of the hearth, partly closing the hearth, is formed of galena and ground bone. The work-stone, *c*, being inclined forward, is furnished with a gutter, *f*, leading into the iron pot, *g*, which is heated from below. A separate reverberatory furnace is used for the working of poorer ores. The ore is roasted by a gradually increased firing at so high a temperature that a thick white vapour is evolved, without fritting together. To prevent the roasting mass from caking during cooling, it is taken from the furnace and thrown into a trough of water.

The Scotch hearth is filled with turf at the commencement of an operation, one burning piece is thrown before the tuyere, and the blast machine set to work, blowing by nozzles 3 to 4 inches wide. The rapidly growing fire in the hearth is increased by adding some shovels-full of coke, and upon these a mixture of oxysulphide, and browse (undecomposed ore and coke rubbish), from the former operation; on this coke is again added. If no more lead is extracted from the browse by the reaction of the oxides upon the sulphides, the mass in the hearth is broken up, and the greater part taken out by means of a scraper and put upon the stone. The brighter parts, or grey slags, from which no more lead can be extracted in the hearth, are thrown aside, and the oxysulphides, with the addition of some lime, are taken back to the hearth, fuel is added, also some shovels of ore (from 15 to 20 lbs.) with lime and the required fuel. A brick of turf is put before the tuyere, the better to divide the blast in the furnace, and to prevent any concentration of heat upon one point. As soon as the masses come under the direct influence of the blast, the extraction of the lead takes place, filling the interior sump; when filled, the lead runs out of the furnace into a lead crucible, from which it is poured by ladles into moulds. When the production of

lead ceases, after 10 or 15 minutes, these operations are repeated. When at the commencement fresh ore is charged, a thick black smoke is developed from the fuel, but afterwards a strong, lighter lead smoke is continually to be seen. This smoke is conducted into a very extensive condensation apparatus which runs to the top of a hill in the form of flues, and enters a rain chamber communicating with a high chimney on the top of the hill. The rain chamber is provided with partition walls, which alternately do not extend either to the roof or the floor. The water standing on the floor shuts the openings beneath the walls, therefore the smoke is drawn by means of a cylinder blast machine through the water, and emitted into the chimney. The blast machine consists of 3 cylinders about 6 feet in diameter, and 8 feet high, and is put in motion by means of a water wheel 50 feet high. The arrangement is made to transmit the smoke direct into the chimney in case some repairs of the blast machine, or rain chamber, should make this desirable. At Nenthead these flues are nearly five miles long.

The Scotch hearth furnaces produce :—

- a.* **Lead**, which is treated after Pattinson's process.
- b.* **Grey Slags**, containing from 1-15th to 1-10th of the amount of lead contained in the ores. They are mixed with a suitable amount of lime, and worked in a slag hearth for the production of slag lead and new slags; the latter flow into water for the separation of the lead which is mechanically contained in them. The slag lead, after being refined, is treated by Pattinson's process.
- c.* **Browse** (undecomposed galena and coke rubbish) is selected for the next operation.
- d.* **Smoke** separates from the water in the reservoirs, and when dried, is worked in reverberatory furnaces. According to Phillips\* the smoke contains from 1 to 1½ per cent of the lead existing in the ores, but a comparatively small amount of silver. The smoke of ores containing 20 ounces

\* Berg u. h. Ztg., 1859, p. 446.

of silver yielding only 2 or 3 ounces in the ton. There is more silver in the first 100 yards of the condensing chamber, measured longitudinally, than in the following 100 yards; and the smoke collected near the chimney shows traces only of silver. About 300 tons of lead are annually collected from the smoke.

From 1 to 2 tons of lead are produced in an operation extending over 14 or 15 hours. Ores containing 73 per cent of lead, yield in a Scotch hearth furnace 60 per cent; from the slags, 3.20 per cent; and from the smoke, 6.91 per cent; the total loss amounts to 2.90 per cent.

1 ton of ore consumes about 1 cwt. 2 lbs. of coal in smelting, 1 cwt. 3 lbs. in roasting, together with 3 lbs. of turf and 2 lbs. of lime.

At Pesey\* in Savoy, 8 cwts. of roasted ore are smelted in 8 hours, yielding from 54 to 65 per cent of lead, and 13 per cent of plumbiferous slags, and consuming 40 to 45 per cent of the weight of the ore in charcoal; 91 cubic feet of air are used per minute. Only 40 to 50 per cent of lead were produced at the smelting of these ores in small cupola furnaces.

#### THE AMERICAN HEARTH PROCESS.

The North American lead hearth† is a modification of the Scotch hearth. The treatment in the North American lead hearth differs from that in the Scotch hearth in the employment of raw ore, a wood fire, and hot blast.

The purest galena must be used, as earthy components will interfere with the roasting in the hearth, as well as with the subsequent reactions. The air, by acting upon the hot ore above the tuyere, forms subsulphide of lead, and sulphurous acid; most of the sulphur is separated in order to allow the oxidation of the lead, and then oxide and sulphate of lead will be formed, as in the Carinthian process; these are then heated still more, in conjunction with sub-sulphide of lead, and produce the metal and sulphurous acid gas by mutual reaction. The iron forming the walls of the hearth

\* LEVILEC, in *Karsten's Archiv.*, 1 R., vi., 148. PUVIS, *Ibid.*, p. 227.

† TUNNER'S *Leob. Jahrb.*, 1852, ii., 176.

exerts a desulphurising and reducing action, and the iron and carbon contained in it combine with the oxygen of the oxide of lead. The conduct of this simple process requires great attention, as too high a temperature causes a considerable loss by volatilisation of the lead and sulphide of lead. When well conducted, the process gives a good yield of lead, and costs little for fuel and labour.

The Backwood hearth :\* formerly in Missouri lead was smelted in square log furnaces, constructed of logs or stones. The front wall is about 8 feet wide and 7 feet high, the interior of the bottom is 2 feet wide and 8 feet long, and 10 or 12 inches thick, forming a kind of boshes with the side walls, 1 foot in width. The inclination of the interior is towards the arch in front, which serves to admit the air, and is temporarily closed with a wall, having a small tap-hole through which the metal flows. A channel communicating with the tap-hole runs the whole length of the bottom. A sump in front of the furnace receives the fused metal, and thence it is ladled into the pig moulds. The operations in this furnace are very simple : a layer of stones is placed upon the channel, and upon them a layer of heavy logs laid horizontally ; then billets of split wood are set upright, and covered with galena, which again is covered with small wood. A fire kindled in the front arch will char the lower parts of the wood first, and the process of reduction will commence as soon as there is enough heat for smelting. The reduced lead flows down through the tap-hole into the basin. One operation requires 24 hours ; after which the furnace is allowed to cool and the ashes are removed, when it is re-charged. About 50 per cent of metal is thus extracted from the ore. The remaining ashes contain much metal, and are subjected to a second smelting in the ash furnace.

The galena occurring on the Mississippi contains only in rare cases as much as one ounce of silver to the ton ; its extraction is only profitable when it contains 6 or 8 ounces. This primitive plan of lead smelting is now obsolete.

\* OVERMANN, Treatise on Metallurgy. New York, 1865.

### Illustrations of the American Hearth Process.

The hearth at Rosie,\* in the State of New York, represented by Figs. 27 and 28, has been many years in use.

FIG. 27.

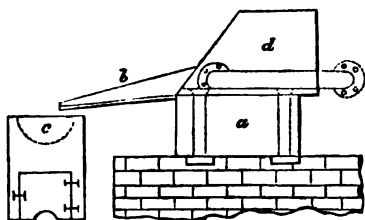
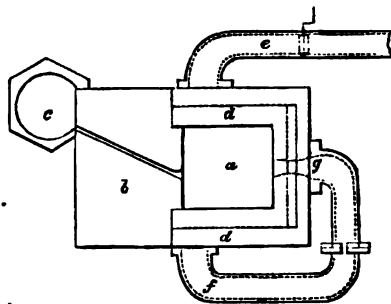

FIG. 28.



The hearth is first carefully warmed by a charcoal or wood fire, and the reservoir, *a*, is filled with lead, which soon assumes a fluid condition. Upon this bath the charge swims during treatment. The workman places several pieces of wood before the blast, and then charges with raw galena; the heat soon permeates the whole pile, and the materials already mentioned oxidising, a reducing action takes place, and the resulting metal flows into the basin, *c*. One operation finished, the furnace is re-charged, and the process is continuous. A more concentrated fuel is found to give too intense a heat, and to prevent the rapid reduction of the ore; a degree of heat sufficient to fuse the galena should be avoided, and a large supply of air is essential.

In 24 hours, 75 cwts. of lead are produced, and the cost per ton for working is about 7 shillings.

English reverberatory furnaces, and cupola furnaces, are also used in America for the production of lead.†

At Bleiberg,‡ in Carinthia, similar hearths formed of cast iron have been used since the year 1843; the ore gives by

\* B. u. h. Ztg., 1842, p. 975; 1860, p. 317. Begwkd, vi., 277. Jahrb. d. geolog. Reichsanstalt, 1856, p. 795.

† OVERMANN, Treatise on Metallurgy. New York, 1852, p. 656.

‡ PLATTNER, in B. u. h. Ztg., 1854, p. 22. TUNNER's Jahrb., 1851, Bd. I., p. 238; 1852, Bd. II., p. 262.

assay 70 to 71 per cent of lead, and from this 61 to 62 per cent of pure lead is obtained, and some residues rich in lead.

According to Plattner, these residues are composed of—

SiO <sub>3</sub>	. . . . .	5·260
SO <sub>3</sub>	. . . . .	5·038
PbO	. . . . .	37·710
Fe <sub>2</sub> O <sub>3</sub>	. . . . .	19·500
ZnO	. . . . .	19·200
MoO <sub>3</sub>	. . . . .	0·460
CaO	. . . . .	8·856
MgO, and MnO	. . . . .	1·417
Al <sub>2</sub> O <sub>3</sub> , KO and NaO	. . . . .	1·760

and they are best re-smelted in cupola furnaces with an addition of loam.

According to Tunner\* the loss of lead in reverberatory furnaces with one hearth, at Bleiberg, during the years 1849 to 1851, amounted to 7·5 per cent; in furnaces with two hearths, to 6·9 per cent; and in the American hearth to 10·51 per cent; the fuel used amounted respectively to 12·8, 8·7, and 5·25 cubic feet per cwt. of produced lead, and to 8·35, 5·68, and 3·34 cubic feet per cwt. of worked galena. The experiments at Bleiberg have shown that the American hearth is advantageous for working pure ores, but when they contain blende, reverberatory furnaces are preferable; the resulting waste is best re-worked in cupola furnaces with an addition of quartz, iron refinery cinders, and cast iron.

### THE CUPOLA FURNACE PROCESS.

Galena, whether poor or rich in silver, is treated in cupola furnaces when it contains enough foreign substances (earths or sulphides) to make it unfit for working in reverberatory or hearth furnaces; sometimes local circumstances, such as a deficiency of cheap and good coal, render cupola furnaces advisable for the treatment of very pure galena. It is usually much cheaper to work galena rich in lead and poor in silver, in reverberatory furnaces, instead of in cupola furnaces, as the former do not require such expensive fluxes, and the yield of metal is larger.

\* LEOBEN. Jahrb., 1852, ii., 262.

Rivot\* has made an interesting comparison of the cost of working, the yield of metal, &c., and the results of the smelting at the works in Tarnowitz (Silesia), in cupola furnaces, with the results of the working of similar ores in English reverberatory furnaces.

Galena with earthy substances is best decomposed by an addition of iron (precipitation process), and ores containing many foreign sulphides are first treated by a roasting, and then by a purifying and reducing smelting (roasting reduction) process; this last process requires an addition of iron. As the choice between these processes depends chiefly on the quality and quantity of the foreign substances contained in the ore, local circumstances, such as the price of the materials, necessitate various modifications of the process.

**Furnaces.**—As impure ores mostly require a higher temperature for smelting, cupola blast furnaces are usually employed; in Spain† and France‡ similar furnaces without a blast, called atmospheric furnaces, have been in use, but the results are unsatisfactory.

**Loss of Lead.**—The construction of the furnace has great influence upon the loss of lead by scorification and volatilisation. The loss occasioned by scorification is partly chemical, caused by the formation of silicate of lead, and partly mechanical, caused by an imperfect extraction of the lead, and of the plumbiferous products, from the slags. If the mixture is properly proportioned, the loss is chiefly caused by the powdered mixture falling through the fuel, and becoming either mechanically enclosed by the slags, or scorified by silica. The best remedies for this are higher furnaces, the employment of the mixture in a more compact form, and, according to Vogl,|| a greater depth of the furnace, so as to give the slags a longer passage before flowing out, and enable the heavier parts, such as lead, matt, &c., to separate.

The loss by volatilisation depends on the velocity of the

\* Rivot, *Métallurgie du Plomb et de l'Argent*, 1860, p. 442.

† B. u. h. *Ztg.*, 1862, No. 7.

‡ *Bulletin de la Société de l'Industrie Minérale*, St. Etienne, ii., 415.

|| B. u. h. *Ztg.*, 1865, p. 1.

blast, and on the pressure which the blast and the hot gases have, and the greater the pressure the greater the loss will be; the loss may be lessened, however, by so constructing the furnace that it is wide from the front wall to the back wall, at the level of the tuyere, and contracted above the smelting zone, and by having it built sufficiently high.

The height and width of the furnace must be modified according to the quantity and the pressure of the blast required for the process; and the more blast and pressure required, the wider and higher must be the furnace. If the mouth of the furnace top is flaming, the loss of metal increases; but some loss takes place under all circumstances, and though every possible precaution may be taken, the loss will still be so considerable as to necessitate spacious chambers above the furnace for the collection of the volatilised lead; the volatilisation is increased when the smelting mixture contains substances which are apt to be reduced in the upper parts of the furnace (white lead ore, litharge, &c.), while the chief reaction—the decomposition of the galena—first takes place in the lower parts of the furnace.

FIG. 29.

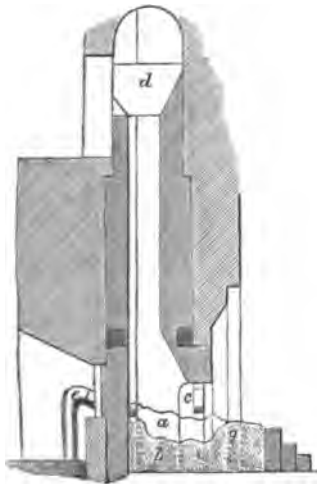
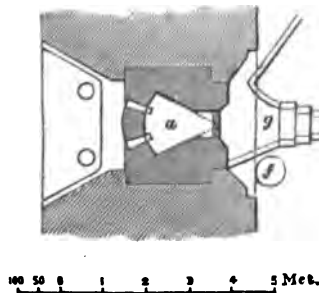

FIG. 30.





**Vogl's\* Furnace.**—This furnace, which is represented by Figs. 29 and 30, is so constructed as to give the greatest possible yield of metal. It possesses,—

1. A great depth, so that the slags travel some distance before flowing out, in order to permit the separation of the contained lead and matt.

2. A great breadth on the back wall.

3. The furnace is worked at a low pressure, and with a light blast, whilst the tuyere has an inclination of  $25^{\circ}$ . The more refractory the ores are, and the greater the necessity for economising fuel, the more blast and pressure are required.

4. A great height, in order to form a sufficient covering.

5. A furnace shaft as narrow as possible, and standing in great contrast to the wide lower part of the furnace. The shaft must be contracted abruptly on its commencement, so as to concentrate the heat in the lower part of the furnace, and to keep cool the upper part, which serves to condense the lead fume, which, when once heated, and beginning to escape, cannot be restrained either by the great height of the furnace or by a low temperature. The small amount of blast employed causes the fuel to be less completely consumed, and also more fuel is required by the swelling of the furnace in the smelting zone; but all these disadvantages are more than balanced by a greater yield of lead. Whereas in the old furnaces 100 cwts. of mixture were smelted with 600 cubic feet of coal, causing a loss of at least 14 per cent of lead, in the new furnace the loss only amounts to 2 per cent at the outside, and consumes 800 cubic feet of coal, which is certainly a saving.†

The neglect of any of these five conditions is at once shown by a flame on the top of the furnace, causing a great loss of lead. The gases emitted from the furnace must be so cool that the hands may be held on the top of the furnace and not burnt, provided the charges have sunk to two-thirds of its height. The same laws regulate the construction both of the iron blast furnaces and the lead cupola furnaces,

\* B. u. h., Ztg., 1855, p. 1, 243.

† Oesterr. Zeitschr., 1862, p. 34.

modified only in the manipulation, or by local circumstances, as, for instance, when the mixture facilitates the formation of deposits in the sump, the furnace must not have a depth of 4 feet 8 inches, and its upper part must also be shallower.

Markus\* states that the loss of lead is considerably lessened by a high furnace, and that each pressure requires a certain height, and that the height of a furnace is determined by the highest pressure intended for it. The following comparison of different furnaces will be found interesting :—

	Joachimsthal.	Przibram.	Freiberg.	Schemnitz.	Hartz.	Silesia.	
<i>a.</i>	50	36	42	42	39	36	Inches.
<i>b.</i>	48	26	64	48	28	28	"
<i>c.</i>	10½	6½	12½	8	6½	6½	"
<i>d.</i>	2	1	2	2	2	1	Feet.
<i>e.</i>	20½	9½	10	13	17	17½	Inches.
<i>f.</i>	23	—	{ Gradually contracted	—	{ Gradually contracted }	—	Lines of mercury.
<i>g.</i>	6	4½	1½	7	7½	—	Cubic ft. per min.
<i>h.</i>	280	8½	157	228	35½	237	Per cent.
<i>i.</i>	—	16	9	17	?	?	

*a.*, depth; *b.*, breadth; *c.*, section at the tuyere; *d.*, number of tuyeres; *e.*, height from the tuyere to the funnel head; *f.*, difference of depth in the upper and lower parts; *g.*, pressure of blast; *h.*, quantity of blast; *i.*, loss of lead.

Lead furnaces have either a regular prismatic form, *e. g.*, the furnaces in Przibram, Schemnitz, &c., or, which is preferable, an irregular form (Freiberg, Joachimsthal, Hartz): round or elliptical furnaces do not answer at all.

The following may be stated with reference to the requirements for the proper construction of lead furnaces mentioned in the preceding page :—

1. The depth of the hearth of the furnace depends chiefly on the fusibility of the ores, on the fluxes at disposal, and on the pyrometric effect of the fuel. An increased depth of the hearth causes a greater consumption of fuel. When it is not deep enough, the smelting masses will not separate properly according to their specific gravity; the blast impinges against the front wall, and causes a strong draught of the gases in the shaft, and a more rapid waste of the hearth takes place. In most cases, a medium depth of 3 feet 6 inches, as in the furnaces of the Upper Hartz, is found most suitable; the limits are 2 feet 6 inches, and 4 feet 6 inches.

2. A great breadth of the back wall is better than the smaller breadth used in most lead furnaces, but the corners projecting into the furnace are so near to the point of the noses as to be rapidly melted. This is almost remedied in Vogl's new furnace.\* (See Fig. 31.)

Fig. 31.

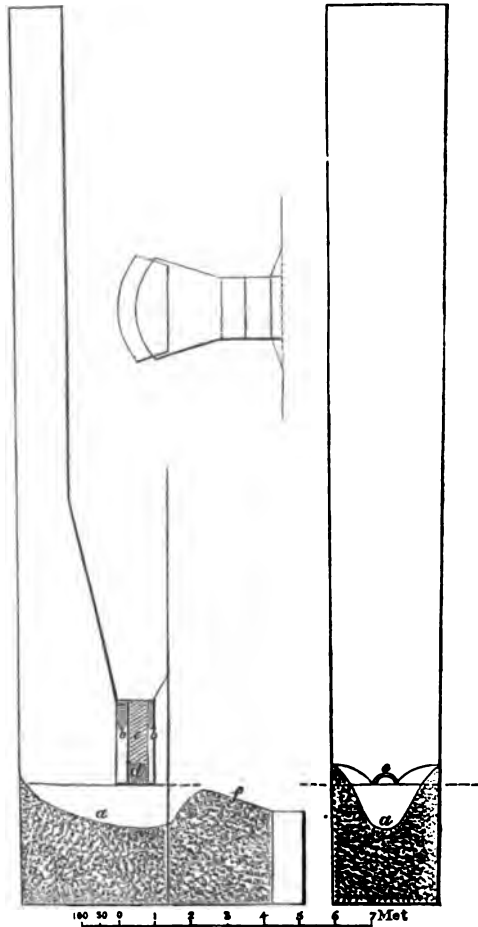

3. Little pressure and a small amount of blast are certainly advantageous, as preventing the volatilisation of the

\* Oesterr. Zeitschr., 1862, No. 5.

lead, but this may be more than counterbalanced by the subsequent smaller production; besides which, the degree of pressure depends on the density of the fuel, and the quality of the ore.

4. A greater height of the furnace acts favourably with regard to the loss of lead by volatilisation and the consumption of fuel; Vogl's new furnaces have a height of 28 feet, and pounded sulphuretted ores require a higher furnace than similar ores in lumps. Oxidised ores and products, when either porous or in the form of powder, are best worked in lower furnaces, as they have been already reduced in the upper parts of high furnaces. To work these ores advantageously in higher furnaces, they should be moulded into the form of bricks, or roasted in a reverberatory furnace till they cake together or become completely scorified.

5. The sudden contraction of the furnace in its shaft has a favourable influence in keeping back the ascending gases; the upper part of the shaft of Vogl's newest furnace is contracted to 18 inches; if the ores contain zinc, this part of the furnace must be at least 21 inches wide. When using a mixture containing much oxide of iron, and employing a dense fuel, it is advisable to widen the shaft of the furnace, and to use a lower pressure,\* in order to prevent the formation of much deposit of iron in the hearth; Vogl's construction, with slight modifications, is adopted in many lead works.

Furnaces with two tuyeres, and either with or without a partition wall, have, in some places, yielded a greater production than furnaces with one tuyere, a saving of fuel taking place at the same time. In other smelting works (Upper Hartz, Joachimsthal) this disadvantage is not found, and as it is also more difficult to keep two noses than one, the furnaces are worked by one tuyere.

These division walls did not answer at Joachimsthal in furnaces with two tuyeres, on account of the great quantity of zinc contained in the ore, which occasioned too much metallic fume in the furnace.

\* v. AMON, in Oesterr. Ztschr., 1857, p. 332, 334.

The hearth, or bottom of the furnace, is formed of a mixture of loam and charcoal dust, firmly rammed down. The basin outside the tympan contains the lead, which is tapped off by opening a tap-hole communicating with the bottom, and the slags are conducted by a slope to another basin, where they accumulate for re-smelting.

The length of the nose must be so regulated that the front wall is kept free from deposit; and by lengthening or shortening the nose, the hearth can be made wider or narrower according to requirement.

#### **B. DECOMPOSITION OF RAW ORES BY MEANS OF IRON. PRECIPITATION PROCESS.**

This process is best adapted for ores rich in lead and poor in silver, associated with siliceous and aluminous gangue, and not containing foreign sulphides to any great amount, as these compounds are more or less decomposed by iron; their base either deteriorating the lead (copper, antimony, arsenic), or causing a loss of metal by facilitating the volatilisation of lead, or the formation of metallic fume (zinc, antimony, arsenic), or by rendering the smelting mass difficult to fuse (zinc blende); the sulphides also cause the formation of products such as speiss, and the matt becomes richer in valuable metals. This process will be found more advantageous the higher the price of lead is, in comparison with iron; as the price of iron is now comparatively high, the only ores profitable to work by this process are those rich in lead; but ores poor in lead may be worked by it if they contain sufficient silver, though the extraction of silver by this method is imperfect.

The advantages of the precipitation process are:—That it saves the roasting of the ore, and allows a more perfect composition of the mixture, thus insuring a safer result than would be possible with roasted ores, as their composition varies according to the degree of roasting. The silica contained in rich ore makes it easier to scorchify the lead in oxidised than in sulphuretted ones; the produc-

tion is less, and a small amount of copper is lost when working roasted ores, whilst in the precipitation process the copper collects in the matt, and may be made profitable.

The disadvantages of the precipitation process are :—The iron is lost by entering into combination with the slag, and an important disadvantage is that the matt, which, together with metallic lead, is formed in the process, contains a considerable amount of lead, often  $\frac{1}{4}$  or  $\frac{1}{5}$  of the whole yield, and also some silver. To extract these metals, the process has to be much protracted, which can only be done with considerable loss of metal; when other sulphides, such as  $\text{Cu}_2\text{S}$ ,  $\text{AgS}$ ,  $\text{SbS}_3$ , are contained in the ore, they also enter into combination with the matt. The amount of lead in the matt may be lessened by employing a suitably high temperature, but the amount of silver cannot be diminished, as sulphide of silver has a greater affinity for sulphide of iron, and therefore will be found in the matt in larger quantity than the sulphide of lead.

If the greater part of lead and silver were extracted from the strongly roasted matt by one operation, most of the copper, as well as antimony, zinc, and arsenic, would enter into the lead; whereas it is only possible to drive them off by repeated roasting, and to extract the argentiferous lead by subsequent smelting processes; the copper will then concentrate into the matt. Part of the silver will be found in the last matt on account of the above-mentioned affinity, and is to be extracted from this matt, or from the black copper produced from the matt.

The smoke, also, and part of the slags contain enough lead and silver to make it worth while to work them over again.

The following have an essential influence upon the success of the process :—

### 1. The Nature of the Ore.

Ores are worked in a pounded state (schlich), or in pieces the size of a nut. The latter is preferable\* when the galena is not too poor in lead, or associated with too many substances

\* ERDM., J., f. ök. u. tech. Chemie, ii., 402, 511. Bergwerksfreund, xi., 572.

as to make it difficult to render fluid (quartz, zinc blende, &c.). Schlich cakes together in the furnace, surrounds and encrusts the fuel, and requires more fluxes and stronger heat, causing the formation of smoke, soot, and deposits; by binding together the schlich with lime,\* or by previously heating it until it frits, these disadvantages may be avoided. Ores in lumps and schlich are seldom worked together, as they require different fluxes.† When worked together they require comparatively more fluxes and iron, and the resulting intermediate products are richer in lead, and the volatilisation of lead is greater. If both kinds of ore have nearly the same amount of metal and a similar behaviour in smelting, they may be worked together advantageously, and the process proceeds more rapidly than the smelting of schlich alone; the latter not being held together by the larger pieces, and the above-named drawbacks in smelting schlich by itself not being so marked. Schlich generally requires higher furnaces, a lower pressure of blast, and larger addition of slag than ores in pieces.

The minerals associated with the ore may be either advantageous or injurious.

**Quartz, Silicates, Lime, Fluor Spar, &c.**, are desirable, provided the amount is not too great, as they assist the formation of slag.

**Sparry Iron Ore** exerts a desulphurising influence.

**Heavy Spar** acts injuriously if present in excess; the sulphate of baryta becomes reduced in the cupola furnace to sulphide of barium, part entering into the matt, and by reaction upon silicate of lead, forming silicate of baryta and metallic lead or sulphide of lead, dependent on the quantity of oxide of lead which had been combined with the silica; in the first case the oxygen of the oxide of lead oxidises both components of the sulphide of barium. The heavy spar is thus decomposed by the lead, and facilitates the fusibility of the slag at high temperature; the reaction of the iron also

\* KARST., Arch., 2 R., xxiv., 430. B. u. h. Ztg., 1852, p. 173.

† LEITHNER, B. u. h. Ztg., 1852, p. 170.

forms an oxysulphide containing baryta, sulphide of iron, and sulphide of barium. This, on account of its specific gravity being between matt and slag, assists the formation of a so-called dull matt (skumnas) which does not completely separate from the slags, causing the production of impure products, and also giving rise to loss of metal.

**Sulphide of Silver** is a valuable component of galena, the economy of the whole process often depending on it, though it causes a lengthening of the operation, as before stated.

The following components are injurious :—

**Sulphide of Zinc** partly enters into the slag, renders it more difficult to fuse, and requires more flux (fusible slags), thus causing a loss of metal, and a greater consumption of fuel (Lautenthal); it is decomposed by iron at a high temperature, and the zinc freed from the blende volatilises, carrying away much lead and silver, chiefly when the blende itself is argentiferous (Przibram),\* and causes the formation of metallic fume and zinciferous products, whose working up again entails greater loss of metal. When oxide of zinc is formed by the influence of the blast or of steam, the slags are also difficult to fuse; sulphide of zinc is more apt to enter the slags as such than to combine with the matt; the resulting slags are then impure, specifically heavy, and do not easily separate from the matt.

**Iron Pyrites** causes a greater consumption of iron, and facilitates the formation of matt; from 8 to 10 per cent of pyrites requires from 2 to 3 per cent of iron.

**Sulphides of Antimony and Arsenic** cause great loss of metal, contaminate the lead, and form soot in the furnace. Arsenic by its greater volatility causes more loss of metal than antimony; arsenic enters less into the lead, and may be more completely separated from it by the cupelling process. More iron is absorbed by arsenic than by antimony. These metals also cause the formation of speiss. If, at the same time, there are nickel and cobalt in the lead ores, this formation of speiss may be considered an advantage, as the cobalt and nickel will collect in it.

\* LEOBEN. u. Przibr. Jahrb. pro., 1857, p. 236.



**Copper Pyrites.** is decomposed by metallic iron,\* the reduced copper follows the lead into all the products, and when a suitable addition of iron is made, may be nearly all concentrated in the matt and then extracted from it (Upper Hartz, Victorfriedrichshütte).

**Bournonite and Grey Copper Ore** act like copper pyrites, but as they contain arsenic and antimony, they also cause loss of metal by volatilisation, and by the formation of metallic deposit.

The greater the difference between the foreign sulphides which occur with the galena from which the metals (silver and copper) are to be extracted, the greater will be the complications of the smelting process.

## 2. The Mixture of the Ores.

A certain quantity of slag is required to prevent, as far as possible, oxidation of lead on the furnace hearth, therefore rich and poor ores, giving a moderate yield of metal, are mixed together as the operator may find desirable. The different earthy bodies must be contained in the mixture in such proportions as to melt together; an addition of an earthy or metallic oxide (oxide of iron) is usually required to form a sufficiently fusible slag.

Experience proves that a more complete decomposition of galena by iron takes place at a high temperature, whilst at a low temperature a matt richer in lead is formed. Sulphides of lead and iron combine at a lower temperature than is required for the extraction of lead from galena by iron, therefore it is necessary to render the mixture so difficult to fuse that the galena gets decomposed at the temperature required for its smelting. As the most fusible combination of silica, alumina, and lime, in the proportion of 56: 14: 30, is still not sufficiently fusible, and as an increase of fuel would cause a great loss of metal by volatilisation, the mixture rendered more fusible by an addition of ferruginous substances (ferruginous lead ores, iron refinery

\* RIVOT's and PHILLIP's copper smelting process: B. u. h. Ztg., 1850, p. 593; 1852, p. 268, 303.

cinders, &c.), tending to form silicates intermediate between mono- and bi-silicates.

The analyses of such slags (from raw ores) of the Upper Hartz\* stand thus:—

No.	SiO <sub>2</sub>	Al <sub>2</sub> O <sub>3</sub>	CaO.	MgO.	FeO.	MnO.	PbO.	SbO <sub>3</sub> .	FeS.	ZnS.	S.	Proportion of Oxygen between SiO <sub>2</sub> and bases.
1	48.80	4.62	3.62	1.24	36.00	—	5.30	—	—	—	—	25.35 : 12.13
2	53.90	4.40	5.60	1.30	32.00	—	4.20	—	—	—	—	28.00 : 11.71
3	43.13	4.76	5.77	0.78	37.72	0.30	6.32	—	—	—	—	22.41 : 13.19
4	45.00	4.62	6.31	0.75	35.83	—	7.80	0.50	—	—	—	23.38 : 12.55
5	47.57	3.21	5.26	0.58	32.28	1.35	3.98	0.22	1.71	1.50	—	24.70 : 11.01
6	53.82	3.82	5.37	1.09	25.90	2.74	4.79	—	3.16	—	—	27.94 : 10.45
7	41.90	4.09	11.64	1.36	34.82	—	2.40	ZnO	0.60	—	—	22 : 14
8	41.00	2.55	6.82	0.62	33.73	1.26	7.25	—	1.58	3.60	—	21.29 : 11.66
9	41.52	10.37	5.22	0.16	35.28	—	6.59	KO	—	—	2.13	21.6 : 14.8
10	34.82	9.77	11.72	1.21	24.61	Cu <sub>2</sub> O 0.33	12.31	0.21	KO	NaO	AsO <sub>3</sub>	1 : 1
11	30.04	7.96	15.93	0.97	22.66	Cu <sub>2</sub> O 0.34	14.13	0.27	2.34 KO	NaO	AsO <sub>3</sub>	15.76 : 18.23
12	37.68	10.23	18.72	0.65	21.23	—	5.19	ZnO	3.80 KO	—	—	20 : 16
13	47.81	7.35	12.25	1.81	23.62	—	6.85	ZnO	2.73	—	—	25 : 15
14	42.93	6.29	10.98	0.23	24.11	—	7.27	ZnO	—	—	—	22 : 13
15	48.20	8.53	6.74	2.68	33.00	—	2.00	—	KO	—	—	—
16	53.14	2.20	5.67	0.33	33.01	—	4.31	trace	5.59	—	—	27.61 : 10.57
17	58.10	3.70	11.03	1.15	21.27	0.80	2.06	BaO	—	—	—	30.18 : 10.55
18	59.86	2.51	10.22	0.62	21.22	0.65	1.68	BaO	—	—	—	31.09 : 9.48
19	57.98	2.59	10.38	0.18	25.94	—	2.46	trace	—	—	—	10.12 : 10.28
20	54.48	6.60	16.16	1.71	19.42	—	1.62	—	—	—	—	28.30 : 12.79

Nos. 1 to 15, schlich slags from the Upper Hartz, mostly

\* KERL's Hüttenkunde, i., p. 845.

bisilicates, are, according to Plattner, mixtures of mono-, bi-, and tri-silicates of the composition,

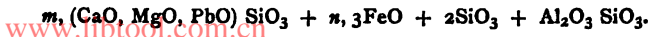

Nos. 16 to 20 are slags produced at the Clausthal lead works, in a blast furnace furnished with boshes; Plattner asserts that their composition corresponds to the following formulæ:—

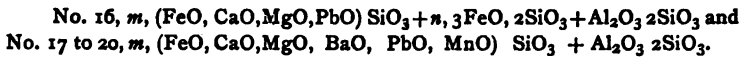

Although the silica is predominant, no great scorification of lead takes place, as the lead in the lower parts of the furnace is not in an oxidised state. A higher degree of silication of the slags adds to the purity of the products. To attain a sufficiently high temperature for melting the mixture, higher furnaces are employed when using charcoal as fuel, and lower when using coke or coal.

The mixture for the precipitation process usually has the following components:—

**Iron**, whether wrought or cast iron, scrap, granulated, or spongy iron; wrought iron is the most effective,\* but Chenot's spongy iron is very efficacious; whilst the cheaper substitutes for iron, such as iron ore, refinery cinders, &c., do not give satisfactory results.

A stoichiometric calculation shows that 1 part of pure iron extracts 3·83 parts of lead, and 1 part of cast iron with 5 per cent of impurities, extracts 3·64 parts, assuming the formation of FeS; but usually Fe<sub>2</sub>S is formed; a surplus of iron is useless.

Less iron is added when the lead ores contain **Copper Pyrites**, in order to avoid as far as possible the decomposition of sulphide of copper, and also when the ores contain **Blende**, to avoid the liberation of much zinc. According to Markus\* arsenic first enters into combination with iron, forming Fe<sub>4</sub>As, and then the surplus reacts upon the sulphide of lead; as the volatilisation of lead and silver decreases by

\* B. u. h. Ztg., 1860, p. 165. KERL'S Metallur. Hüttenkunde, i., p. 376. Oesterr. Ztschr., 1857, No. 1. B. u. h. Ztg., 1857, No. 8.

the union of the arsenic to iron, an increased addition of iron lessens the loss of metal ; therefore a larger addition of iron is desirable when the ores contain **Arsenic**.

**Sulphide of Silver** is decomposed by iron in the same way that sulphide of lead is, and when a certain amount of iron is added, the decomposition of both sulphides is complete; if the addition of iron is increased, a proportionately greater amount of lead is extracted, as the sulphide of silver, on account of its great affinity to sulphide of iron, is more apt to collect in the matt. Since the extraction of silver from the matt would require an addition of lead, it is preferable to produce, by a smaller addition of iron, a matt richer in lead. Sulphide of silver is also decomposed by metallic lead in a similar way, and a different proportion of lead is required for extracting a certain quantity of silver, depending for instance on the state of combination of the sulphide of silver\* (whether it occurs with galena only, or with sulphides of copper or iron), and on the temperature employed.†

The reaction of the iron is also reducing as well as desulphurising, for by it, in the presence of coal, oxide of lead and silicate of lead may be transformed into metallic lead and silicate of iron, the carbon of the cast iron taking part in this reduction.

Experiments show in every case how much iron may be added to the mixture ; the pieces of iron must not be large enough to sink too quickly, and they must be consumed before the smelting mass comes in front of the tuyere. Lime only decomposes galena under the oxidising influence of air, forming metallic lead and sulphate of lime. Silicate of lead only gets decomposed at a higher temperature ; and lime, together with ferruginous slags, assist the extraction of iron from the slags, and facilitate the desulphurising action.

**Slags**, chiefly rich in iron. These act mechanically in the upper part of the furnace by rendering the smelting mass (chiefly schlich) less compact, and above the tuyere they

\* Oesterr. Ztschr., 1857, No. 1. B. u. h. Ztg., 1857, No. 8.

† Oesterr. Ztg., 1855, No. 5, 24 ; 1856, No. 13.

form easily fusible silicates, the scorified lead and part of the copper being extracted by iron, coal, and sulphide of iron ; only a small part of the iron contained in the slags, reduced by the contact with fuel, exerts a desulphurising action ; sparry iron ore acts in a similar manner.

As it increases the consumption of fuel, the quantity of slag added must not exceed a certain limit, except for ores containing zinc blende, and when the schlich is too compact ; in such cases a larger addition is advisable.

Substances rich in Oxide of Lead (Litharge, Hearth scum, &c.) are better reduced with coal in reverberatory furnaces at a low temperature, as they become reduced in the upper part of the cupola furnace, and great part of the contained lead volatilises. They must be used in large quantities when working ores rich in silver and very poor in lead (Andreasberg lead works), and they are then best moulded into bricks.

### 3. The Construction of Cupola Furnaces.

Cupola furnaces vary in height according to the ore smelted ; ores in the form of schlich require higher furnaces than ores in larger fragments, as the schlich forms very compact masses, whilst rich galena and ores containing blende may be worked in furnaces of less height ; and again, on the other hand, ores associated with much earthy matter require higher furnaces. The highest temperature is to be obtained in furnaces furnished with boshes.\*

The lower part of these furnaces (the hearth) is, according to what is required of it, constructed in different ways.

a. The bottoms of some are furnished with a kettle-like reservoir, from the deepest part of which a channel conducts the smelted masses into one or more outside basins ; this channel may be closed by a plug of clay. This reservoir is called a crucible, and hence these furnaces are called *crucible furnaces*. If they have also an aperture in the front wall for removing the slags, they are called *crucible*

\* Bergwerksfreund, ii., 257. KARSTEN'S Archiv., 2, R., x., 131. LAMPADIUS, Fortschritte, 1839, p. 77. KERL'S Oberharzer Hüttenprocesse, 1860, p. 576.

*furnaces with open breast*; without this aperture, *crucible furnaces with closed breast*.

These furnaces do not waste heat, and admit of the full reducing reaction of the gases. The workmen suffer less from heat and have easier work, the production is larger, the action of the blast machine need not be arrested when tapping off, the slags are hotter, poorer in metal, and almost free from mechanically included metallic products, the molten products are more completely separated, &c. But, on the other hand, the furnaces have the following disadvantages:—The deposits formed in the hearth cannot be removed, which is of great importance to the length of the operation; the great reducing power of the furnaces facilitates the formation of iron deposits, and a chemical reaction upon the molten masses may possibly take place beneath the tuyere. These furnaces are chiefly used for ores which are difficult to fuse, and which do not easily form deposits.

Roasted lead ores (Stolberg, Belgium) are sometimes smelted in such furnaces; the mixture is then rendered easily fusible by an addition of iron refinery cinders, but only short operations can be made, as deposits are not altogether to be avoided.

b. In some furnaces the reservoir for collecting the smelted products lies outside, and the smelted masses flow from the sloped bottom of the furnace through one or two apertures in the front wall into crucibles. The products either flow from above into the crucibles, when such furnaces are called *channel furnaces with open eye*, or they are conducted by means of a covered channel from the interior of the furnace from below into the crucible, and are then called *channel furnaces with covered eye*.

These furnaces are chiefly advisable for all smelting processes in which certain qualities of the smelting products, such as great oxidability, make a quick removal from the furnace desirable (reduction of litharge). The channel furnaces with covered eye prevent the air influencing the products outside the furnace, which the furnaces with an open eye do not do. The construction is somewhat complicated,

and therefore the third kind of furnace (sump furnace) is often preferred.

Channel furnaces, like the crucible furnaces with open breast, concentrate temperature and reducing gases, thus effecting an economy in fuel, but causing the formation of deposits. The saving of fuel is balanced by the loss in temperature caused by the masses flowing out. This lowering of the temperature renders the separation of the molten masses less complete, and causes the formation of slags richer in metal, which require a re-working, and entail an unnecessary consumption of fuel.

c. Sump furnaces are furnished with a collecting basin inside and one outside before the front wall, communicating with each other by means of a channel, and called the sump; and the furnaces are named *sump furnaces*. The smelted metallic masses are conducted into another basin by a channel which can be closed by a plug; the slag usually flows out from above.

These are the furnaces chiefly in use, as they allow the removal of formed deposits, and therefore admit of more lengthy operations.

The loss of temperature and reducing gases may be lessened by covering the outside basin and lowering the front wall.

4. **Fuel.**—Charcoal and Coke are chiefly used.\* Porous coke is not fit for smelting schlich, as the latter is apt to enter the cavities, and the complete combustion of the coke thus encrusted is prevented.

Coke, in consequence of its density, burns slower than charcoal, and causes a slower movement of the charge through the furnace; but as it is able to bear a larger charge, it smelts an equal quantity in about the same time as charcoal; its smelting value may be somewhat higher, as coke does not form so much carbonic oxide. As coke occasions a higher temperature, the galena necessarily gets more completely decomposed, a more perfect separation of the

\* KARSTEN'S, *Archiv. i R.*, vi., 96. KLEINSCHMIDT, *Bergbaukunde*, ii., 103. FOURNET, *Annales des Mines*, 2 sér., tom. vii., 453. KERL'S *Oberharzer Hüttenprocesse*, 1860, p. 251.

products takes place, and the resulting matts and slags are poorer in lead ; but, on the other hand, it is more difficult to regulate the nose. As the coke forms a more compact mass in the furnace, it is found that less ore dust is carried away when it is used for melting ore in the form of schlich. This has caused an increased yield of lead.

Lower furnaces are used when coke is employed, in order to avoid too high a temperature.

Of the **Raw fuels**, Coal only has been used in Tarnowitz,\* for wood and turf do not give good results.†

### THE SMELTING PROCESS.

It will be found when the process is normal that the charges become gradually heated in the upper part of the furnace, and that the white lead ore, if it is present as well as lead products (litharge, hearth scum), are partly reduced, causing a volatilisation of lead ; at the same time volatilised sulphide of lead escapes from the lower parts of the furnace ; if higher sulphides are present they lose part of their sulphur, and sulphuretted hydrogen gas may be formed by the reaction of the steam. The greater the amount of lead reduced and volatilised, the more porous will be the oxidised substances. At a certain height above the tuyere, when the masses have become pasty, the sulphide of lead becomes decomposed by contact with the iron, and metallic lead and sulphide of iron, the latter in combination with some sulphide of lead, drop on to the hearth ; hence part of the lead is oxidised and volatilised when passing the tuyere. If the charges pass too quickly, the iron comes less in contact with the sulphide of lead ; the iron should have disappeared altogether in the zone of the tuyere, as its reaction in the hearth cannot be relied on. Only at a higher temperature and very little above the tuyere the ferruginous slags begin to combine with the earthy substances, and part of the oxidised iron becomes reduced by contact with the fuel, the separated iron having a desulphurising

\* KARSTEN'S Arch., 1 R., viii., 103.

† KERL, Oberharzer Hüttenprocesse, 1860, p. 238, 241. B. u. h. Ztg., 1860, p. 102.



action ; but this reaction is only secondary, as the quantity of slag is comparatively small. Also, little decomposition of sulphide of lead takes place by the direct reaction of the oxidised iron, as this is mostly combined with silica. Most of the metallic lead is extracted from the silicate of lead by metallic iron. In the case of a surplus of iron, most of the copper would be extracted ; but when this is not the case, the copper, both that which is reduced from the oxide and that which has combined with silica, will enter the matt. Sulphides of iron and zinc are very effective in the decomposition of cupriferos silicate of lead, as they form metallic lead and sulphide of lead and copper. In this way may be produced a lead nearly free from copper, slags poor in copper and lead, and a matt which contains the greatest part of the copper.

Most of the lead and matt which are mechanically mixed with the slags, will be deposited, and when they are liquid flow slowly from the furnace ; the smelted masses separate according to their specific gravities.

The following appearances will indicate the process :—

When the raw lead has a dull surface and is pasty, it is an indication that it contains a certain amount of sub-sulphide of lead, the result of too sparing an addition of iron.

The quality and behaviour of the matt are treated of on page 85.

The chief characteristic is the nature of the slags ; whether they approach in composition a bi-silicate, what degree of fusibility they possess, whether they are pasty in consequence of the presence of oxysulphide, &c.

The arrangement of the nose must also be taken into consideration.

It should be here stated that the charging of the ore mixture is conducted on the back wall, where the tuyere is, and the charging of the fuel on the front wall ; as the charges sink towards the tuyere, fuel and ore become more and more blended. This mode of charging is adopted for ores which are easily rendered fusible and which do not require a very powerful reduction, and when certain components of the ore are required in the oxidised state and to become scorified.

Smelting with a nose is mostly connected with this manner of charging; the nose is a prolongation of the tuyere, and is formed into the shape of a tube by the cooling of the mixture or slags. A certain quantity of slags (*nose slags*) is charged at the beginning of the process to form the commencement of the nose, and it may then be made any length, by charging more or less ore-mixture upon the charge of fuel, which is kept constant, but it does not usually exceed 18 or 20 inches. The formation of the nose may be facilitated by putting iron covered with moist loam into the furnace through the tuyere; the slags will adhere to it and become cool; the nose may be turned in any direction by means of this iron, and elongated as much as may be desired.

This construction of the nose has the following advantages:—

It preserves the tuyere, which is usually made of bronze, from an early destruction by heat and from the influence of such components as sulphur; it also prevents a forcible protrusion of the glowing mass from the tuyere; it transfers the smelting point from the back wall into the interior of the furnace, thus again saving the tuyere from burning, and it renders it possible to fix the smelting focus in any part of the furnace; as it is pierced in front it divides the blast equally in the furnace, thus facilitating a uniform smelting of the mixture, which glides gradually from the inclined plane. As the blast is divided by the pierced nose, the fine particles of ore are less easily carried away; the process in the furnace depends chiefly on the length and the clearness of the nose; when clear and short it indicates a higher temperature than when long and dark. Various unsuccessful attempts have been made to overcome the disadvantages of the nose; such as to smelt in furnaces with boshes\* with clear noses; and though regular smelting is obtained by dividing the blast in several tuyeres, yet they are left unprotected from the noxious influence of the sulphides.

\* KARSTEN'S Archiv., 2 R. x., 131; Bergwerksfreund, ii., 257; KERL, Oberharzer Hüttenprocesse, 1860, p. 576.

Too great heat at the mouth of the furnace should be avoided, as flame would cause a volatilisation of metal ; attention must be paid to the regular passing of the charges, and to the temperature on the front wall, as much increase shows that the nose is too long, &c.

And, lastly, the nature of the hearth is to be considered, namely, to what extent it is free from deposits, whether the blast is passing out of the fore-hearth, whether the tap-hole is hard, &c.

The following are the remedies for improving an irregular process :—Increasing or decreasing the charge of mixture whilst the charge of fuel is kept constant, this serves to raise or lower the temperature ; an addition of acid or basic slags according to the fusibility of the slags ; an increase of the quantity of slags when the mixture is difficult to fuse ; clearing the hearth ; regulating the nose and the blast, &c.

**The Products of the Precipitation Process** are as follows :—

1. **Lead.**—If it contains more than 0·031 per cent of silver, it is treated by Pattinson's process, which extracts the silver, and at the same time renders the lead very pure.

2. **Lead matt**, containing about 30 per cent of lead, 0·094 per cent silver, and more or less copper. According to the metal it contains it is either thrown aside (Tarnowitz) ; roasted for the production of mixed vitriols, (Victorfriedrichshütte) ; used for the production of cement copper (Siberia) ;\* on account of its iron, it is used as an addition when smelting ores and residues (Sala, Tarnowitz) ; or when it contains a large amount of valuable metals it is worked again by itself (Upper Hartz). This last working consists in repeatedly roasting the matt, and in treating it by a precipitating and purifying smelting process in a low cupola furnace (Krummofen), with an addition of iron and acid slags. The oxide of lead which has been formed by roasting becomes reduced ; when a suitable temperature is used the oxidised iron of the roasted matt is combined with the slags from the ore smelting, forming a basic slag (matt slag) ;

\* B. u. h. Ztg. 1852. p. 503.

the sulphide of lead, which is not decomposed by the roasting process, or has been produced by reduction of sulphate of lead, is decomposed by the metallic iron which was either added to or reduced from the oxide of the charge; and a new matt is formed into which all the copper present concentrates. If this smelting process is carried on in higher furnaces, too much iron becomes reduced; this forms iron deposits on the hearth, and partly causes the copper to collect in the raw lead, whilst the resulting slags are poor in lead; too great an addition of metallic iron produces a similar reaction. The addition of iron is so regulated that the greater part of the copper enters into the matt, and only a small part collects in the raw lead; the resulting slags are somewhat richer (Upper Hartz). The same roasting and smelting processes are then repeated with the matt 2 or 3 times, till a raw lead rich in copper results, and until the copper becomes more and more concentrated in the matt; antimony arsenic, zinc, sulphur, &c., are volatilised in these processes. If the matt contains more silver, it is best to make no addition of iron to the first matt smelting, or better still to none, or the resulting copper matt becomes too rich in silver; when this is the case the silver must, by different processes, be extracted from the matt or from the raw copper produced from it (Upper Hartz). If the copper matt contains enough antimony and arsenic to injure the quality of the copper, it is smelted in a blast reverberatory furnace (Andreasberg); lead matts rich in silver and lead may be separated from the greater part of their lead and silver by suitable fluxes before roasting, thus avoiding a great loss of copper.

The chemical changes in working matt and in the roasting precipitation process of the ore, resemble each other very closely.

3. **Speiss.**—Arseniates and antimoniates are seldom formed in this process.

4. **Ore or Schlich Slags.**

5. **Smoke and Fume, Scum, &c.** These are either added to the mixture when smelting ores and matt, or are worked alone.

H

### Illustrations of the Precipitation Process.

In the Upper Hartz,\* at Clausthal, Altenau, Lautenthal,† and Andreasberg, dressed galena containing silver‡ in the form of schlich, and from 40 to 70 lbs. of lead and 0.05 to 0.33 lb. of silver per cwt., is chiefly worked. These ores contain earthy minerals in large quantities (calc spar, quartz, baryta, clay, &c.), and less, but still enough to be influential, of metallic minerals (copper and iron pyrites, zinc blende, bournonite, &c.). At Andreasberg the galena is worked together with real silver ores (red silver ore, &c.). The processes at Clausthal and Altenau are very similar. At Lautenthal there are some modifications, as the ores worked there contain zinc blende, and the difference in the process at Andreasberg is caused by the silver ores.

The schlich are so mixed that those principally containing sparry iron ore as their associated minerals are worked together with those having difficultly fusible matrices. They are mixed in such a proportion that the average yield in Clausthal and Altenau amounts to from 54 to 56 lbs. of lead and 0.1 lb. of silver per cwt., and in Lautenthal from 62 to 64 lbs of lead and from 0.09 to 0.1 lb. of silver. The schlich is smelted with an addition of iron, schlich slags, matt slags, and plumbiferous products.

The iron|| is used in the form of grains, scraps, and turnings.

Basic lead matt slags absorb silica, and prevent lead from

\* *Annales des Mines*, 1 sér., vii., 159. *Bergmännisches Journal*, 1790, 8. stck, p. 97. *LAMPADIUS*, *Hüttenkunde*, ii., Thl. 2 Bd., p. 7, u. 229. *Suppl. i.*, 31, ii., 192. *ZIMMERMANN'S Harzgebirge*, i., 481, ii., 432. *JARS*, *metallurg.*, *Reise*, iii., 514. *HERON DE VILLEFOSSE*, *Mineralreichthum nach Hartmann* Bd. iii., 4 *Abthl.*, *Cap.*, 2. *KARSTEN'S Metallurgie*, v., 162. *WEHRLE'S Hüttenkunde*, ii., 246. *HARTMANN*, *Repertor, der Bergbau und Hüttenkunde*, 1840, ii., 265. *RUSSEGER'S Reisen*, iv., 688. *KERL*, *Oberharzer Hüttenprocesse*, 1860, 2 Aufl. *KERL*, *Der Oberharz*, 1852, p. 40. *Geschichtliches: B. u. h. Ztg.*, 1859, No. 2.

† *Rivot*, *Métallurgie du Plomb et de l'Argent*, p. 450

‡ *KERL*, *Oberharzer Hüttenprocesse*, 1860, p. 16. *COTTA*, *Erzlagerstätten* ii. 90. v. *DECHEN*, *Statistic des zollv. and nördlichen Deutchl.*, i., 756.

|| *NOLTE*, *Über die Grösse des Eisenzuschlages: Berg und hüttenmännische Zeitung*, 1860, p. 165. *KARSTEN'S Archiv.*, 2 R., x., 131. *KERL*, *Oberharzer Hüttenprocesse*, 1860, p. 362. *ZIMMERMANN*, *Harzgebirge*, i., 450. *Bergwerksfreund*, ii., 265.

scorifying; they also render the process in the furnaces hotter, and cause a quicker smelting, but not an invariably better yield. Acid schlich slags have a contrary effect upon the process; otherwise the slags serve to prevent any movement of the schlich, and to protect the molten metallic products from oxidation and volatilisation. The blende in the ore at Lautenthal, and the gangue in the silver ores at Andreasberg, necessitate a greater addition of basic slags.

The fluxes, consisting chiefly of oxide of lead, are added to the mixture partly to extract the metal contained in them, and partly to assist the extraction of the silver from the ore (Andreasberg). In these last works the fluxes are given in such quantity that in poor mixtures 0.01 lb. of silver is contained in every 4 to 5 lbs. of lead, and in rich mixtures 0.01 lb. of silver in every 2 to 3 lbs. of lead.

The following table will show the composition and yield of a mixture containing 36 cwts. of mixed schlich:—

At the smelting works of Clausthal—

*Mixture.*

36 cwts. schlich with 0.10 p. c. of silver and 54 to 56 p. c. of lead.

6 cwts. fluxes with 0.008 to 0.0175 p. c. of silver and 57 to 80 p. c. of lead.

12 cwts. schlich slags with 0.008 p. c. of silver and 3 p. c. of lead.

34 cwts. matt slags with 0.006 p. c. of silver and 1.5 p. c. of lead.

---

92 cwts., containing 3.6 to 3.7 lbs. of silver and 27 cwts. of lead.

*Yield.*

19 to 20 cwts. of raw lead with 0.13 to 0.16 p. c. of silver.

16 cwts. of matt with 0.07 p. c. of silver and 29 p. c. of lead.

48 cwts. of slags with 0.008 p. c. of silver and 3 p. c. of lead.

3 cwts. of fume with 0.05 p. c. of silver, and 45 p. c. of lead.

210 cubic feet of charcoal = 14.7 cwts.

10 hours' time for smelting.

£3 cost for smelting. Operations of 8 to 10 weeks.

At the smelting works in Altenau—  
*Mixture.*

36	cwts. of schlich.
2	„ granulated cast iron.
2	„ bore chips.
1	„ scum.
1½	„ fluxes.
22	„ matt slags.
17½	„ schlich slags.

The amount of metal in the mixture is nearly the same as in the Clausthal smelting works.

82 cwts.

*Yield.*

17 cwts. of raw lead.  
15 to 16 cwts. of matt.  
1 to 2 „ smoke.  
24 to 25 „ charcoal.  
10 to 11 hours' time. Operations of 10 to 14 weeks.

At the smelting works in Lautenthal—

*Mixture.*

36	cwts. of schlich with 0'09624 p. c. of silver and 60'55 p. c. of lead.
2'43	cwts. of hearth with 0'0125 p. c. of silver and 68 p. c. of lead.
1'22	cwts. of fluxes with 0'01 p. c. of silver and 88 p.c. of lead.
0'61	cwts. of scum with 0'0025 p. c. of silver and 82 p. c. of lead.
25'98	cwts. of schlich slags with 0'0009 p. c. of silver and 5 p. c. of lead.
32'79	cwts. of matt slags with 0'0009 p. c. of silver and 4'5 p. c. of lead.
4'50	cwts. of iron.

103'53 cwts., containing 3'562 lbs. silver and 27'73 lbs. lead.

*Yield.*

15'45 cwts. of raw lead with 0'13 per cent of silver.  
17'15 cwts. of lead matt with 0'07 p. c. of silver and 41 lbs. of lead.  
46'32 cwts. of pure slags with 0'0049 p. c. of silver and 5 lbs. lead.  
14'086 cwts. of impure slags with 0'0037 p. c. of silver and 5'6 lbs. of lead.  
0'922 cwts. of soot with 0'062 p. c. of silver and 50 lbs. of lead.  
Requiring 200 to 210 cubic feet of charcoal.  
12 hours' time for smelting. Operations of 4 to 5 weeks.

The consumption of charcoal amounts to about 380 cubic feet. In the smelting works of the Upper Hartz charcoal only was formerly used, but coke is now almost exclusively employed, and with good results. The process is more uniformly carried on, on account of the higher temperature on the hearth given by the coke; the gases escaping from the furnace are also cooler, as less combustion takes place in the upper parts of the furnace. At Lautenthal, where ores associated with blende are worked, a greater formation of fume in the upper part of the furnaces was observed.

The furnaces in use are represented by Figs. 32, 33, 34, 35, and 36.

FIG. 32.

FIG. 37.

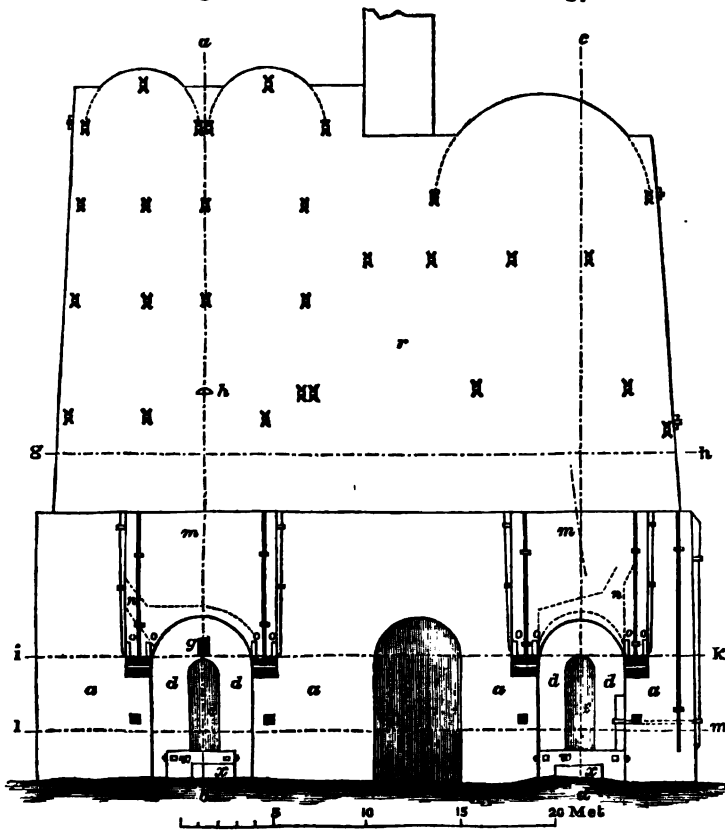



*a* is the mantle; *b*, the back wall; *c*, counters; *d*, front wall; *e*, opening of the front wall; *f*, breast; *g*, an opening for removing soot, &c.; *h*, an opening showing the flame of  
 FIG. 33.

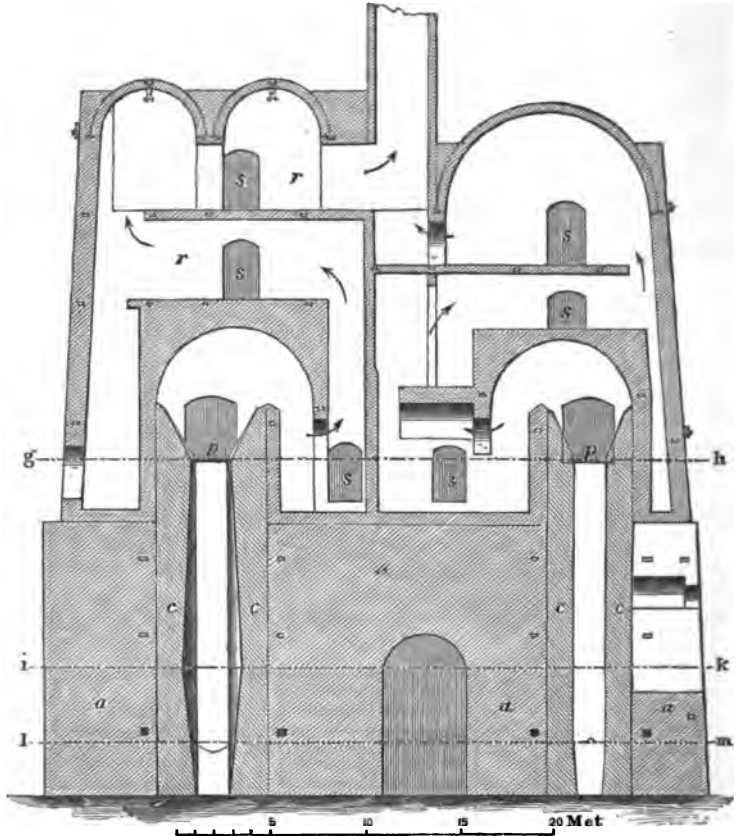

the furnace, so that if anything escapes from the furnace mouth, it may be observed by the smelter working before the hearth of the furnace; *i*, tuyere arch; *k*, opening for the tuyere; *m*, chimney hood; *n*, channel leading to the smoke chambers; *p*, mouth of the furnace; *q*, platform for charging the furnace; *r*, smoke chambers or boxes; *s*, openings for removing the smoke; *t*, foundation; *u*, sole stone; *y*, is formed out of loam; *z*, bottom composed of a mixture of coke-dust and fire-clay.

Figs. 37, 38, 39, 40, and 41 represent the furnaces used at the Upper Hartz for reducing litharge, and will be referred to when that process is treated of.

A porous nose about 12 or 18 inches long is used in the precipitation process. One charge consists of 2 or 3, or alternately 2 and 3 troughs of mixture 60 lbs. and coal 25 lbs.; the furnaces at Lautenthal are made somewhat wider on account of the blende with the ores.

The following are the smelting products :—

1. **Raw Lead.**—This is either treated by Pattinson's process for the production of a very pure lead (Altenau), or directly cupelled for extracting the silver.

FIG. 34.

FIG. 39.

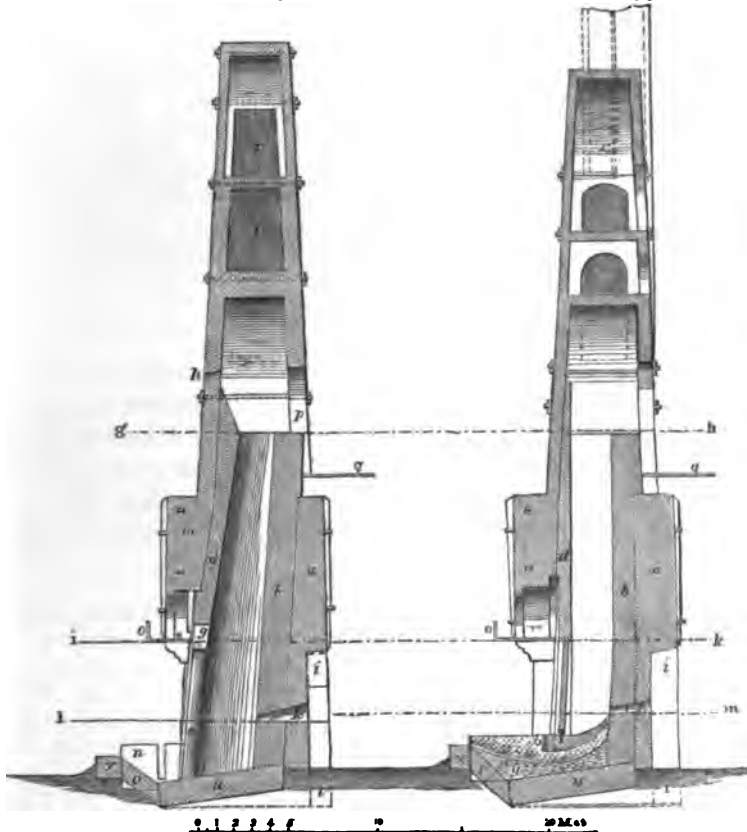

FIG. 35.

FIG. 40.

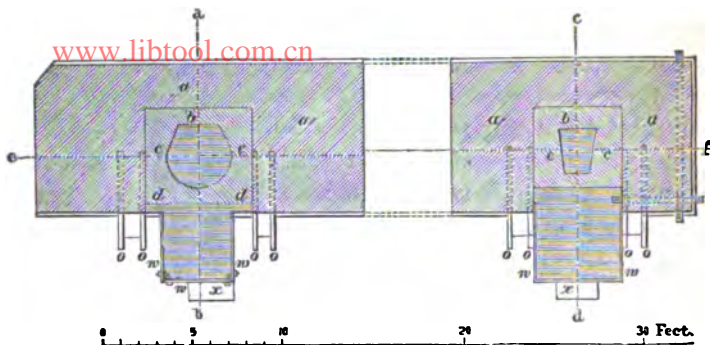
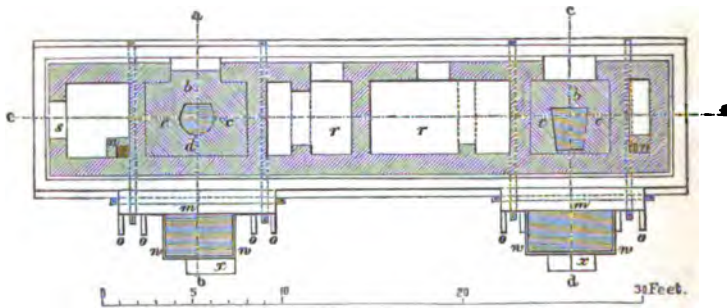

FIG. 36.

FIG. 41.



The raw lead from the Upper Hartz contains, according to analyses by Jordan, from 95·97 to 99·00 per cent of lead, 0·40 to 0·76 per cent of copper, 0·28 to 2·96 per cent of iron, 0·20 to 3·46 per cent of antimony, and 0·11 to 0·18 per cent of silver. Such lead from Pontgibaud contained 91·1 per cent of lead, 0·7 per cent of copper, 6·7 per cent of arsenic, and 1·0 per cent of sulphur.

2. **Lead matt.**—The following analyses have been made of different lead matts from the upper Hartz.

A matt from Clausthal contained 73·346 per cent of lead, 9·814 per cent of iron, 0·396 per cent of copper 0·198 per cent of tin, 0·397 per cent of antimony, 0·116 per cent of silver, 15·338 per cent of sulphur, and a trace of carbon. A matt from Lautenthal contained 59·33 per cent of lead,

19.60 per cent of iron, 1.10 per cent of copper, 0.17 per cent of tin, 0.13 per cent of antimony, and 18.92 per cent of sulphur. A matt from Andreasberg contained 35.68 per cent of lead, 31.55 per cent of iron, 3.79 per cent of copper, 1.49 per cent of antimony, 23.97 per cent of sulphur, 0.25 per cent of manganese, and 1.07 per cent of arsenic.

For the composition of these matts different formulæ have been suggested.\*

Lead matt is roasted under cover, in heaps about 24 feet long, 16 feet broad, and 5 to 6 feet high, put upon a thick layer of pine wood laid down for the foundation, for about 3 or 4 weeks. The matt has to be broken into pieces of about the size of the fist for this purpose. After this first roasting it is put into a second fire for two weeks, then into a third for 8 or 10 days, and in two more for shorter periods, till the matt has been sufficiently freed from sulphur. 5 tons of matt require for the different roastings about 120 cubic feet of pine wood = 75 cubic feet solid wood = 1,912 lbs.

The roasting mass is then mixed with schlich slags, matt slags, products containing lead and iron (Clausthal) or lime (Altenau); at Lautenthal no iron is added to the first smelting of the roasted matt, but to the following smeltings instead; at Andreasberg no iron is added.

The reducing and purifying smelting is intended to reduce the oxide of lead contained in the roasting mass, and to decompose sulphate and sulphide of lead by the iron which has either been added, or extracted from the matt slags by the reaction of the lime, aided by the fuel. The foreign oxides, chiefly oxide of iron, become scorified by the acid ore slags; the metal must also be extracted from the furnace products containing lead.

The mixture for 1 charge of matt at the first smelting is composed as follows:—

\* POGGEND., liv., 271. HAUSMANN, Beiträge zur metallurgischen Krystallkunde, 1850, p. 10, 12. LEONHARDT, Hüttenerzeugnisse, p. 383, 340. GURLT, pyrog. min., p. 22, 37. RAMMELSBURG, Mineralogie, p. 177. POGGEND. Annalen, 1858, No. 3, p. 526. Jahrbuch des Vereins für Naturkunde in Nassau, 1851, p. 133. B. u. h. Ztg., 1860, p. 52. ERDMANN'S Journal für praktische Chemie, 1859, hft. 1. Polytech. Centr., 1858, p. 1161.

		Clausthal.	Altenau.	Lautenthal.	Andreasberg.
Matt	cwts.	34	34	34	33
Iron	"	1	—	—	—
Lime	"	—	3	—	—
Impure ore slags	"	34	23	28	37-38
Hearth	"	6	3	2	—
Matt and hearth remnants	"	2-3	1	—	—
Lead scum and slags from the litharge melting	"	—	2	—	—
Fluxes	"	—	—	½	} 12-24
Dross	"	—	—	½	
Time for smelting	hours	10	9·8	7	24
Consumption of charcoal	cubic feet	15	10	9½	—
Do. coke	cwts.	8	7	8	—
Quantity of blast p. min.	cubic feet	260-290	—	230-250	159
Length of one campaign	weeks	3-4	5-6	3-4	—

### The products are—

Raw lead	cwts.	11·6	9·5	13	—
Matt	"	12·6	9·8	10	—
Slags	"	54	—	40½	—
Fume	"	0·1	—	0·23	—

Low cupola furnaces (Krummofen) are used for smelting the matt; those at Clausthal are 8 feet 7 inches high, those at Lautenthal are nearly 2 feet higher, and at Andreasberg they are only 5 feet high.

The resulting raw lead is treated by the cupelling process; the matt is again melted two or three times, being each time previously roasted. At the third or fourth smelting a copper matt is obtained, containing 20 to 36 per cent of copper and 0·06 to 0·1 lb. of silver. This is then worked by a separate process (Kratz copper process) for the extraction of its metals.

The resulting matt slags are more basic than the ore slags. The following analyses will show their composition:—

	SiO <sub>3</sub> .	CaO.	Al <sub>2</sub> O <sub>3</sub> .	PbO.	FeO.	Cu <sub>2</sub> O.	MnO.	KO.	MgO.	S.	Proportion of Oxygen between SiO <sub>3</sub> and bases.
1.	32·34	2·07	5·06	10·01	43·90	0·05	1·20	0·05	—	—	16·80 13·89
2.	33·58	3·57	4·46	6·19	44·44	—	trace	0·05	—	—	23·09 11·12
3.	39·79	2·12	trace	9·17	46·44	—	—	—	—	trace	20·68 11·57

3. **Lead Fume.**—An analysis of this is given on page 24. From the schlich smelting at Clausthal and Altenau 7 or 8 per cent of smoke result, at Lautenthal 10 or 11 per cent, and at Andreasberg 0·8 to 1 per cent. This smoke is smelted together with dressed scum containing 0·10 to 0·03 lb. of

silver and from 35 to 40 per cent of lead, in schlich furnaces, when combined in the following way:—

At Clausthal, 36 cwts. of smoke, 9 cwts. of scum, 12 cwts. of roasted matt of the smoke smelting, 3 cwts. of iron, 5 cwts. of plumbiferous fluxes, 45 cwts. of schlich slags, and 6 cwts. of hard lead slags; at Altenau, 54 cwts. of smoke, 18 cwts. of scum, 13 cwts. of roasted matt of the smoke smelting, 4 cwts. of iron, 3 cwts. of plumbiferous fluxes, 28 cwts. of schlich slags, and 20 cwts. of matt slags; at Lautenthal, 30 cwts. of smoke, 6 cwts. of scum, 2 cwts. of iron, 6 cwts. of plumbiferous fluxes, 26 cwts. of schlich slags, and 29 cwts. of matt slags; at Andreasberg, 36 cwts. of smoke and scum, 2 cwts. of iron, 12 cwts. of plumbiferous products, and 73 cwts. of matt slags.

The consumption of coal at Clausthal amounts to 230 cubic feet; at Altenau, to 350 cubic feet, and Lautenthal to 186 cubic feet, and at Andreasberg to 250 cubic feet; and the yield of raw lead at Clausthal to from 16 to 20 cwts., at Altenau to 18 cwts., and at Lautenthal to from 11 to 12 cwts.; and that of matt at Clausthal to from 15 to 19 cwts., at Altenau to from 18 to 19 cwts., and at Lautenthal to from 12 to 13 cwts.

11 per cent of the lead fume escape reduction by being again volatilised during the smelting.

4. **Plumbiferous Deposits** are usually roasted and smelted at the end of the schlich operation, mixed with iron slags.

According to Metzger\* the deposit from the furnaces at the Upper Hartz consists of—

PbS	FeS	ZnS	Sb <sub>2</sub> S <sub>3</sub>	AgS
95·5	3·2	trace	2·5	trace.

5. **Speiss** is sometimes produced in smaller quantity, as at Andreasberg.

6. **Furnace Ends** are dressed and worked together with smoke or by themselves.

7. **Schlich Slags** are worked up again or used for the construction of cupola furnaces, and sometimes even formed into bricks and employed for building purposes.

\* B. u. h. Ztg., 1853, p. 238.

The loss of lead at Clausthal, Altenau, and Lautenthal, amounts to 14 or 16 per cent; from 2 to 6 per cent of this loss is occasioned by the schlich roasting and matt smelting processes, 8 or 10 per cent by the cupelling process, and about 2 per cent by the process for reducing the litharge. The yield of silver is higher than the result of the assay by 1 or 2 per cent. At Andreasberg, on account of the large amount of antimony and arsenic in the ore, the loss of lead sometimes amounts to 60 per cent, and the loss of silver to 1 per cent.

The production of the smelting works at the Upper Hartz amounted in the year 1859-60 to 22,035½ lbs. of silver, 435 tons of lead, 297 tons of litharge, and 68 tons of copper, of a total value of £193,000.

The lead produced varies in quality.

At Victor-Friedrichshütte, near Harzgerode (Lower Hartz), the smelting process differs in the following points from that used on the Upper Hartz:—The galena is worked in two forms, as schlich, and in fragments whose cubic side measurement is  $\frac{3}{4}$  to  $1\frac{1}{2}$  inches. These two kinds are mixed together; the fuel employed is a mixture of coke and charcoal, and as the ore mixture contains a small amount of metal, it possesses a basic nature. The galena contains from 32 to 34 lbs. lead, and, on an average, 0.056 lbs. of silver per cwt. It is associated partly with sparry iron ore, partly with blende, quartz, and clay-slate, and partly with fallow silver ore, and with copper pyrites, which contains in 5 tons from 12 to 16 cwts. of lead, and 8 to 11.5 lbs. of silver.

Sump furnaces are used for smelting, and in 24 hours from 4 to 5 tons of ore are smelted.

The yield from 5 tons of ore is—

20 to 23 cwts. of raw lead, containing 0.147 lbs. of silver; 32 to 34 cwts. of lead matt, containing 27 to 30 lbs. of lead, and 0.058 to 0.066 lbs. of silver;  $8\frac{1}{2}$  cwts. pure slags, with 4 to 6 lbs. of lead, and 0.002 lb. of silver; smoke,  $\frac{1}{2}$  per cent.

The lead matt is worked up as in the Upper Hartz. The annual production amounts to about 1,135 lbs. of silver, 310 tons of litharge, and from 35 to 45 tons of vitriol.



At Friedrichshütte,\* near Tarnowitz, in Upper Silesia, the galena† is found partly in compact layers alternating with and disseminated through dolomite, and partly in iron-ochre, in lumps or grains. It is also associated with iron pyrites, calamine, and brown iron ore, and is poor in silver. The lead ores from the calamine mines are richer, and contain from 0·06 to 0·1 per cent of silver.

**Smelting Ores in Fragments (Knorper).—**This was formerly done in low cupola furnaces (Krummofen)  $3\frac{1}{2}$  feet high, but since 1848 channel furnaces with closed eye  $16\frac{1}{2}$  feet high have been in vogue. The higher furnaces have enabled the smelting process to be better and more regularly carried on, and have caused a greater yield of metal; they also occasion less loss of lead by volatilisation, and produce poorer slags. On the other hand, the consumption of fuel and fluxes for the process is greater, and longer time is required, but these disadvantages are outweighed by the increased yield. 100 cwts. of ore with 50 to 70 per cent of lead (often in pieces of the size of the fist) are smelted together with 19 cwts. of iron,  $5\frac{1}{2}$  cwts. of refinery cinders, and 30 to 40 cwts. of lead slags, in 20 hours, consuming 50 cwts. of coal, and yielding—

a. 50 cwts. or so of raw lead, dependent on the quality of the ore.

b. 30 cwts. of lead matt, with about 9 per cent of lead.

c. 40 cwts. of impure slags and hearth-ends.

**Smelting the Schlich.—**The schlich ores, containing from 30 to 44 per cent of lead, are mixed with lime; 100 cwts. of schlich and 72 cubic feet of lime. This mixture is moistened with water, and bricks are formed of it, which are allowed to dry in the air during 48 hours.

100 cwts. of schlich require 8 cwts. of iron, 24 cwts. of

\* KARSTEN'S Archiv., 1 R., i., 135; vi., 170; vii., 54; 2 R., viii., 103; xxiv., 430. ERDMANN'S Journal für ök. u. techn. Ch., xv., 120, 237, 392. Ann. d. Min., 1 sér., vii., 54; xii., 101; 4 sér., iv., 377; vi., 213; xiii., 271. KARSTEN'S Métallurgie, v., 157. HARTMANN'S Repert., ii., 289. Bergwerksfreund, ix., 369. B. u. h. Ztg., 1852, p. 173, 470. RIVOT, Métallurgie du Plomb et de l'Argent, 1860, p. 76, 390.

† V. DECHEN, Statist. des zollv. u. nordl. Deutchl., i., 757. COTTA, Erzla-gerstätten, ii., 238, 708.



refinery cinders, 84 cwts. of coal, and 44 hours' time for smelting; and they yield 30 per cent of raw lead, 15 per cent of lead matt, and 50 per cent of impure slags. The operations only last 6 or 8 days, as the ores conduce to the formation of a great deal of zinciferous soot.

According to Rivot the loss of lead by volatilisation and in the slags, which are thrown away, amounts to 10·5 per cent; the loss of silver to 6·4 per cent; and the smelting cost for 1 ton of schlich is £1 12s. 7d.

**Smelting the Residues.**—5 tons require 3 cwts. of iron, 8 cwts. of refinery cinders, 22 cwts. of coal, 4 cwts. limestone, and 16 hours' time; and yield 4 to 4½ cwts. of raw lead, and matt containing 2 per cent of lead, which is thrown aside along with the pure slags.

According to Rivot the yield of this process amounts to 87 per cent of the lead, and 96·50 per cent of the silver, and the smelting costs 8s. 5d. per ton.

The three processes together cause a loss of 4·48 per cent of the lead, and 14·30 per cent of the silver, and the smelting cost of 1 ton of ore amounts to £1 18s. 11d. The high price of the iron and cinders used makes this process expensive; and the necessity for a more perfect dressing of the ores free from silica, and enriching them from 65 to 75 per cent of lead, has been the cause of the introduction of the English reverberatory process.

In the year 1861 were produced: 1,408 tons of lead, 560 tons of litharge in lumps, 228 tons of common litharge, 57 tons of sifted litharge, and 4,179·183 lbs. of silver.

At Przibram, in Bohemia, the galena\* occurs in veins in greywacke, containing from 4 to 12 ounces of silver per cwt., and is chiefly associated with zinc blende containing silver up to 6 ounces, besides real silver ores, and sparry iron ore in smaller quantities; the prevailing gangue is quartz or greywacke (up to 15 per cent), with some admixture of calca-

\* CORTA, *Erzlagerstätten*, ii., 201. GRIMM, im *Leob. u. Przibr. Jahrbach für*, 1855, p. 93; 1857, p. 231. LILL v. LILLENBACH, *Verhalten des Erzadels, gegen die Teufe im Bericht über d. erste allgem. Versammlung von Berg und Hüttenmännern in Wien*. Wien, 1859, p. 12. *Oesterr. Zeitschrift*, 1861, No. 15.

reous spar and baryta. The amount of silver contained in blende makes a very careful preparatory dressing of the ore necessary, and the amount of blende and quartz in the ore, and the absence of iron pyrites, render their smelting difficult.

After many trials the following processes have been adopted for the different ores:—

1. The rich lead ores are worked by the precipitation process.

2. The poorer lead ores are roasted in English and double reverberatory furnaces, and afterwards worked in cupola furnaces with iron and ferruginous substances.

3. The argentiferous blende and the poor lead ores containing blende are roasted in double muffle furnaces (*vide* Zinc) for the formation of sulphates and the production of sulphurous acid, which is conveyed into lead chambers for conversion into sulphuric acid.

Analysis shows the rich ores to consist of—

Galena . . . . .	89 to 90	per cent.
Blende . . . . .	3'0 to 3'5	„
Sulphide of antimony . . . . .	1'5 to 1'8	„
Sulphide of silver . . . . .	0'55 to 0'59	„
Iron partly oxidised and partly sulphuretted . . . . .	1'5 to 2'0	„
Quartz and aluminous substances . . . . .	3'1 to 3'3	„

The galena contains 77 or 78 per cent lead, and 14 per cent sulphur.

The smelting mixture is composed as follows:—

		<i>a.</i>	<i>b.</i>
Ore . . . . .	cwts.	40	25
Lead slags . . . . .	„	10	10
Dross . . . . .	„	4	3
Rich litharge . . . . .	„	—	2
Hearth . . . . .	„	4	—
Small coal . . . . .	„	—	2
Iron . . . . .	„	4	3½
Refinery cinders . . . . .	„	20	14

This mixture is melted in cupola furnaces. The different smelting processes carried on at Przibram are explained subsequently.

At Joachimsthal the new smelting process is carried out as follows:—Principally silver ores are worked here,\* they are mostly associated with quartz and a little lime and alumina, 5 per cent at the outside. The silver chiefly occurs in a native state, and as ruby silver ore; most of the ores contain 5 per cent of lead as galena, and some bismuth, cobalt, and nickel, combined with arsenic and iron, are present in almost all ores; iron pyrites is only rarely present. Some uranium† and vanadium‡ are extracted by Patrer's method.

The first essential improvement of the former process was introduced by Vogl in his new construction of the furnaces|| which are mentioned on page 81. According to Vogl, the following expedients for avoiding a great loss of lead may be used with advantage, in addition to the new construction of the furnace:—

*a.* The formation by protoxide of iron and lime of a basic slag, easily fusible and decomposable by acids.

*b.* An amount of lead in the mixture exceeding 20 per cent.

*c.* So large an addition of iron that the formation of deposits in the hearth is unavoidable at the end of the operation. This will cause the highest yield of silver from the smallest quantity of lead.

*d.* Smelting at as low a temperature as possible, with high charges, and a small pressure of blast ( $2\frac{1}{4}$  to 4 inches water), and a tuyere from  $1\frac{1}{4}$  to  $2\frac{1}{4}$  in. diameter.

*e.* An inclination of the tuyere of at least 25 degrees, and rather a dark nose.

*f.* Most perfect working up of the metallic soot, iron deposits, &c.

\* J. F. VOGL, *Gangverhältn. und Mineralreichthum, von Joachimsthal Teplitz*, 1856. STERNBERGER, *Joachimsthaler Bergbau: Oester. Zeitschr.*, 1857, p. 33. J. F. VOGL, *die secund. Gebilde der Joachimsth. Gruben. Oester. Zeitschr.*, 1856, p. 353. COTTA, *Erzlagerstätten*, ii. 34.

† *Oester. Zeitschr.*, 1856, p. 95, 230, 242; 1857, p. 40, 53. *Bergwerksfreund*, Bd 22, No. 37. *B. u. h. ztg.*, 1861, p. 391.

‡ *Oesterr. Zeitschr.*, 1856, p. 230, 244. WAGNER'S *Jahrsbericht*, 1859, p. 134.

|| *B. u. h. Ztg.*, 1855, No: 1—3, 30—32. *Oesterr. Zeitschr.*, 1857, p 51, 89; 1862, No. 5.

Though these improvements were important, more economical processes in the wet way have of late been introduced. Since the year 1859, the rich lead ores have been submitted to the precipitation process in Vogl's furnace. Ores containing 71 per cent of lead, cause a loss of only 0.9 per cent of lead when smelted in that furnace. Silver ores containing no lead, or not more than 15 per cent, are treated according to Patrera's process (*vide* Silver).

At the Marienhütte, in Kinzigthal (Baden), mixtures of the following composition are worked in cupola furnaces:— 14 cwts. of galena, containing 48 to 55 lbs. of lead and 1 to 1½ ounces of silver, 23 cwts. of mixed ores (galena, copper pyrites, malachite), containing 7 lbs. of lead and ¾ ounce of silver, and 4 cwts. of silver ore with 2 ounces of silver, 15 cwts. of refinery cinders, and 18 cwts. of copper slags.

At the smelting works in Münsterthal (Baden), galena schlich, containing 50 lbs. of lead and 2½ ounces of silver per cwt., is worked in cupola furnaces 6½ feet high. In the matt of those works, Sandberger found Ni<sub>3</sub>, Cu<sub>6</sub>, Sb<sub>3</sub>; the same alloy was found by Hausmann in furnaces at the Upper Hartz. These works produce annually 470 lbs. of silver and 65 to 70 tons of litharge.

At the smelting works at Ems (Nassau), the precipitation process was formerly adopted, but it is now discarded.

In Sala (Sweden) argentiferous galena, which occurs in granular limestone, is worked, associated with zinc blende, a little iron pyrites, some gypsum, quartz, and silicates of magnesia. It is smelted in cupola furnaces 19 feet high.

At Ruszkberg (Banat), a mixture of 24 cwts. of argentiferous galena, 24 cwts. of brown lead ore, 29 cwts. of argillaceous iron ore, 12 cwts. of roasted lead matt, 1 cwt. of iron pyrites, and 10 cwts. of limestone is profitably worked in cupola furnaces 20 feet high.

#### TREATMENT OF ROASTED ORES WITH IRON, OR SOME FERRUGINOUS FLUX.

##### Roasting Reduction Precipitation Process.

This process is used for ores which are either so rich in foreign sulphides, antimonides, and arsenides, as to be unfit

for the common precipitation process, or so rich in earthy siliceous matter, that they cannot be worked in reverberatory furnaces. It would be possible to work these last ores by the common precipitation process; but in some cases local circumstances, chiefly the price of materials, make a previous roasting desirable (Commern, Ems). Ores poor in lead and rich in silver, associated with different gangues, and which, on account of the presence of this amount of silver, cannot be sufficiently dressed, are best adapted for this process. The disadvantages have been spoken of on page 83. The process is carried on in the different works with modifications dependent on the nature and the aggregation of the ore, and on local circumstances. The reaction process is intended to transform the sulphides as much as possible into oxides, and to volatilise antimony, arsenic, zinc, &c.; the oxides are then submitted to a reducing and purifying smelting. Matt is thus formed in small quantity, but containing the greater part of the copper present; the degree of roasting must be regulated according to the amount of copper contained in the ore.

The roasting of the ores is conducted,

1. **In Heaps**, either with or without shelter; used for ores containing a very large quantity of foreign sulphides, and which cannot be completely roasted on account of the copper contained in them (Hartz). Those ores contain sufficient sulphur to burn by themselves. Pot-like depressions are stamped in the porous covering of the roasting pile, and the sulphur being sublimed from below collects in them, and is dipped out from time to time in a liquid state; the quantity is about sufficient to pay the cost of roasting.

When the ores contain less sulphur, they must be provided with intermediate layers of fuel (Müsen, Rothenbach.)

2. **In Mounds**; they permit the fuel and temperature to be better regulated, and are used for the same ores as those before described; but the roasting process cannot be carried on completely and uniformly with these arrangements.

3. **In Cupola Furnaces**: chiefly used when the sulphur

is employed for the production of sulphuric acid (Oker in the Hartz).

4. In **Reverberatory Furnaces**, with one or two hearths, either one above the other, or side by side; they give the best result in roasting, and are mostly employed. Furnaces with two hearths are more difficult to work, but they effect a saving of fuel. According to Vogl, furnaces with one hearth and a long grate are more economical to work than English furnaces with short grates. If the sulphurous acid, formed by the roasting, is to be used for the production of sulphuric acid, these furnaces must be combined with muffle furnaces (Przibram, Freiberg), and the roasted ore must have been previously more or less ground.

According to Vogl,\* an addition of coal is advantageous in the roasting of lead ores. When the roasting is well conducted, the sulphides will be nearly all transformed into oxides. In contrast to the common roasting, the temperature in the last period is sometimes raised so high that the roasting mass either cakes together, or completely fuses. This is done† either with the object of doing away with the pounded form of the ore, which is injurious in cupola furnaces; or in order to decompose the sulphate of lead by silica so as to counteract the formation of matt, and to save ferruginous fluxes. As the components of the roasting mass (oxide of lead, sulphate of lead, and some undecomposed galena) are brought into nearer contact by the caking, a reaction of the oxide upon the sulphuretted substances will be produced during the process in the cupola furnace; and, as in the reverberatory furnace, metallic lead and sulphurous acid will be formed. When the ore does not contain sufficient silica, the deficiency must be supplied by an addition of quartz sand. The silicate of lead which has been formed together with other silicates must be decomposed by ferruginous substances. The sulphuration will be most complete when the galena is treated at a gradually rising temperature, as in the French roasting

\* B. u. h. Ztg., 1856. p. 61.

† KACHELMANN in Oesterr. Zeitschr. 1857 p. 162, 179.

process, when it mostly changes into sulphate of lead, which again is decomposed by silica at a high temperature; but the drawback to this operation is the greater consumption of fuel. If a great amount of sulphates of lime and baryta has been formed in the roasting mass, they must be decomposed by silica at a continued high temperature. A complete scorification is advisable if a sufficient quantity of ferruginous substances can be added in the subsequent smelting; also when a saving in fuel and labour is desired in working ores poor in lead, and when the scorification is facilitated by the presence of white lead ore (Commern, Ems, Stolberg).

Foreign substances associated with the ore are sometimes advantageous and sometimes injurious to the roasting process.

**Iron Pyrites** requires a lower temperature: containing a large amount of sulphur, it requires more time for roasting, and forms sulphates in large quantity, thus necessitating a large addition of silica and a high temperature for decomposition; but these disadvantages are more than counterbalanced by the favourable influence of the oxide of iron formed. Undecomposed sulphide of iron increases the yield of matt; the presence of pyrites acts advantageously in preventing the volatilisation of lead and silver, by transforming them into sulphates.

**Zinc Blende** has an invariably injurious action in this process. The best treatment for ores containing a great amount of blende is to roast them first by themselves, and afterwards with coal several times.

**Sulphide of Antimony** in ores is highly deleterious, and a roasting of such ores with coal is advisable.

**Arsenical Pyrites** likewise causes a loss of metal.

**Copper Pyrites** does not interfere with the roasting process, but part of its copper always enters into the lead and decreases its value (Lower Hartz, Müsen, Rothenbach.)

**Grey Copper Ore** acts similarly, and, on account of the antimony and arsenic it contains, also increases the loss of metal.

**Sulphide of Silver** is easily roasted.

**Sparry Iron Ore** is converted by the roasting process into peroxide of iron and counteracts caking of the ore; it acts favourably in the smelting process; if there is a large amount associated with the galena, siliceous fluxes must be added, and the smelting process conducted in low furnaces and with a low pressure of blast.

**Heavy Spar** has no influence upon the roasting process, and acts favourably upon the fusibility of the slags in the smelting process.

**Lime** hastens the roasting by absorption of sulphuric acid, and acts, like baryta, as a flux for silica.

### Smelting the Roasted Ores.

The result depends chiefly on the roasting, the choice of suitable fluxes, and on the furnaces. The roasting mass chiefly contains metallic oxides, reducible in different degrees; and this process is intended to reduce the oxide of lead as quickly as possible, and to scorify those oxides which are difficult to reduce.

Experiments have been tried so to compose the mixture\* as to form slags of mono-silicates, or of a combination of mono- and sub-silicates with a metallic base, chiefly protoxide of iron (basic silicate of iron and lime), which may be formed at a sufficiently low temperature, and which, not having a high specific gravity, allow a separation of the smelting products, except when zinc blende is present in large quantities. If the slags are too basic, and contain excess of iron, their easy chilling and reduction of too much iron cause an impure result and shorter operations; and if their specific gravity is too high they do not separate sufficiently from the matt, thus causing loss of metal. If they are too acid, contain too little iron, and are not rendered more easily fusible by oxide of lead, they require a higher temperature for their smelting, causing a considerable volatilisation of lead and greater reduction of foreign oxides,

\* Oesterr. Zeitschr., 1857, No. 1. B. u. h. Ztg., 1857, p. 51, 91.



chiefly oxide of iron. As acid fluxes, slags and sometimes quartz are used ; as basic fluxes, refinery cinders, iron ore, roasted matt, &c.

The ferruginous substances not only react in the formation of slags, but also in the extraction of lead. Protoxide of iron, as a strong base, expels the oxide of lead from its silicate, which may then be reduced by coal ; also one part of the protoxide of iron is always reduced to metallic iron, and has a desulphurising action upon the undecomposed sulphide of lead, and a reducing action upon silicate and oxide of lead ; and as no means are given to control this reduction of oxide of iron, the product is apt to be injured, and deposits of iron formed in the hearth of the furnace. This formation is advantageous towards the end of the operation, as it proves that there was sufficient iron in the mixture, which is essential for the yield of lead and silver (Joachimsthal).

The reduction of refinery cinders is still less subject to control than the reduction of rich iron ore, as the refinery cinders are difficult to reduce, and nearly all enter the hearth without being decomposed ; and as the processes are uncertain with both the substances, metallic iron\* is employed in many smelting works, as it not only decomposes sulphide of lead but also reduces oxide of lead. At the same time the sulphide of iron acts upon the silicate of lead, forming metallic lead, sulphurous acid, and silicate of iron. Sulphides of barium and calcium, formed by the reduction of the respective sulphates, act in a similar manner, and sulphide of barium is sometimes added to the mixture in order to produce such a reaction (Vialas).

If iron ore and metallic iron are expensive, the fuel may act as a substitute, either in part or wholly ; but enough oxidised iron must be contained in the mixture to form an easily fusible slag ; and for this purpose the roasting is carried out as completely as possible, and the sulphates formed are chiefly decomposed by silica at a high temperature ; the mixture is then combined with coal or coke and slowly smelted in low furnaces, the upper mouth part of them being

\* B. u. h. Ztg., 1857, p. 67.

flaming (Vialas, Spain). Compared with smelting with iron, this process causes a great loss of metal, a large consumption of fuel, and a small production.

The chief advantage of the roasting process over the common precipitation process is the non-formation of matt; but the formation of matt is necessary when a loss of silver is to be expected, or when the mixture contains a larger amount of copper (Müsen, Lower Hartz); or again, when for these reasons the roasting must not be carried on so far, and when the roasting process depends on the smelting in the cupola furnaces. Small quantities of matt are dissolved in the slags, and large quantities are allowed to remain in them; thus the slags contain more or less silver (Przibram). If a small quantity of matt is separated, and if it is poor in lead and silver, it is treated like the ores without much cost and loss of metal; but if a greater quantity is obtained, and it is rich in copper, lead, and silver, more elaborate processes are required, causing great expense and loss of metal (Lower Hartz, Müsen, Freiberg).

If the roasting process is incompletely carried out with ores containing antimony and arsenic, a formation of speiss takes place in the smelting process, and its working up causes loss of metal.

Products rich in lead are frequently added to the mixture, partly in lumps and partly in the form of powder; to avoid a loss of metal the powder should be heated until it cakes, or mixed with lime, as before directed, and worked up separately when containing much lead. The presence of zinc blende in the mixture causes most of the modifications of the smelting process.

Low cupola furnaces are best for smelting roasted ores, as they cause a less formation of iron deposits in the hearth, and of metallic soot when smelting ores associated with zinc, thus allowing longer operations. If these inducements do not exist, the application of higher furnaces is advisable, as effecting a saving of fuel and less loss of metal by volatilisation. These furnaces must always be provided with a chamber for condensing the unavoidable smoke.

On account of the basic and ferruginous mixture which facilitates the formation of deposits, the furnaces used are mostly constructed like sump furnaces; in rare cases only channel furnaces are used, as in the smelting works on the Rhone, whilst crucible furnaces (Commern, Stolberg, Przi-  
 bram) are much used. In the latter case, the lower part of the front wall is furnished with a door suspended on hinges, and having its inner side covered with clay; these furnaces allow a better separation of the matt and lead, as it takes place at a higher temperature in the interior of the furnace.

For fuel, charcoal, coke, or a mixture of both are employed, the last giving the highest yield of metal; coke produces a high heat in a small space before the tuyere, and charcoal a lower heat in a greater space.

When the process is going on properly, less reduction of oxide of lead and volatilisation of lead and silver will take place in the upper part of the furnace, if the smelting masses be less porous or pulverised; on the other hand, a reduction of the oxide of iron now begins if the furnace is not too low, and the grain of the ferruginous flux not too coarse. The masses become softer and gradually fuse as they sink into the furnace. Part of the oxide of lead is reduced by coal and iron, sulphates are decomposed by the fused silicates, and the oxidised lead is extracted from the latter by oxidised iron, which allows the reduction of oxide of lead by coal; undecomposed sulphide of lead, and that reduced from the sulphates, get decomposed by metallic iron; and the sulphide of iron thus formed has a partially decomposing action upon silicate of lead, or forms a matt, if present in larger quantity, together with other sulphides, whilst a fusible slag, poor in lead, is formed at the same time. The action of the coal is stated on page 118. If the ores contain zinc, the previously described reactions take place; the process is effected by a nose from 8 to 12 inches long, and the mouth of the furnace must be kept free from flame.

The results of the process are judged satisfactory or not according to the products obtained, which are as follows:—

1. **Raw Lead**, usually more impure and more brittle than

that obtained by the precipitation process; it contains an amount of Sb, As, Zn, Cu,  $Pb_2S$ ,  $Pb_4S$ , &c. It is submitted to Pattinson's process for the extraction of its silver, and, if necessary, previously refined.

2. **Lead Matt** with varying quantities of Pb, Cu, and Ag. If the amount of these metals is small, it is treated like ore, otherwise the treatment followed is that stated on page 96.

3. **Speiss**, usually of the composition  $x(Fe, Ni, Co)_2 As + y(Fe_2S, Cu_2S, Pb S)_n + RS (As, S_2, Sb S_2)$ ; it is sometimes worked in order to extract the Pb, Ag, Cu, Ni, and Co contained.

4. **Slags** of basic nature; the pure slags are thrown aside, the impure ones re-worked.

5. **Metallic Smoke**, from roasting and smelting, is either mixed up with the smelting mass, or burned, together with from 15 to 20 per cent quartz, in reverberatory furnaces. In this operation part of the lead may be extracted by mixing the smoke with coal. If the ores contain blende, the smoke contains oxide and sulphate of zinc, and is rich in silver.

6. **Furnace Ends**; these, if carefully worked up, lessen the loss of metal.

### Illustrations of Smelting Ores Poor in Lead and Associated with Pyrites and Blende.

In the three smelting works near Goslar (Lower Hartz),\* the lead ores † of the Rammelsberg are worked; besides galena they contain a great deal of iron pyrites, some copper pyrites, zinc blende, arsenical pyrites, antimonial ores, baryta, calc spar, quartz, argillaceous clay, &c., so that the average amount of lead in the roasted ores does not exceed from 4 to 10 per cent.

\* LAMPADIUS, *Hüttenkunde*, ii. Thl., Bd. p. 110; B. u. h. Ztg., 1853, p. 6; 1854, p. 1, 97; 1859, p. 37; 1862, p. 105. JARS, *metallurgische Reise*, iii. 404. RUSSEGGERS' *Reisen*, iv., 675. KERL, *der Communion Unterharz*. Freiberg, 1853. KERL, *die Rammelsberger Hüttenprocesse*, Clausthal, 1861.

† B. u. h. Ztg., 1853, p. 6; 1860, p. 14, 439; 1861, p. 391. CORTA, *Erzla-gerstätten*, ii. 103. v. DECHEN, *Statist. d. zollv. u. nördl. Deutschlands*, i. 754.

The roasting of the ores is effected as before described. Lead ores associated with much blende (brown ores) are washed with water after the first roasting, and the solution is used for the production of sulphate of zinc.

The roasted ores contain from 4 to 10 lbs. of lead per cwt.,  $\frac{1}{8}$ th ounce of silver, and 1 lb. of gold in about 1,850 tons. As these ores contain a large amount of foreign oxides, chiefly peroxide of iron, a great quantity of siliceous flux is required, and schlich slags of the Upper Hartz are used for this purpose.

One mixture for the smelting process consists of—  
35 cwts. of ore.

10 „ schlich slags of the Upper Hartz.  
 $\frac{1}{4}$  to  $\frac{1}{2}$  „ litharge and hearth ends,

besides some cwts. of roasted matt, scum, soot, &c., according to necessity; the amount of lead yielded by such mixture is 4 cwts.

The furnaces in use are represented by Figs. 42, 43, and 44; they differ from other furnaces of this kind in the singular

FIG. 42.

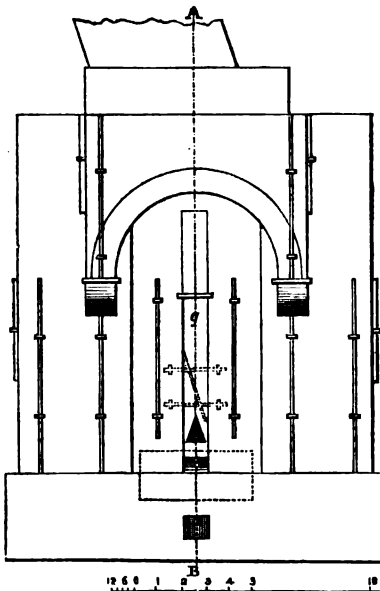

FIG. 43.

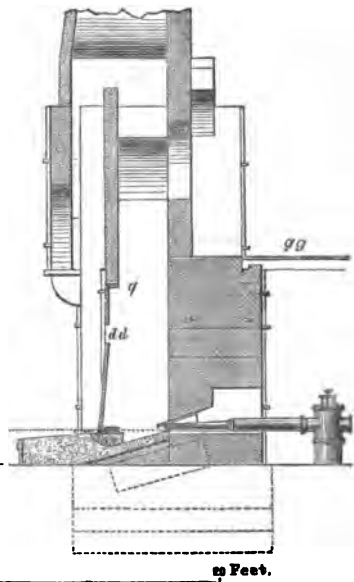
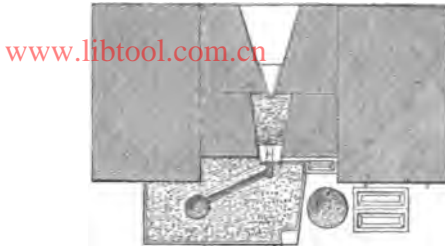

FIG. 44.



Ground Plan of Figs. 42 and 43, or Section through the Tuyere.

construction above the channel, shown by the drawing at *y*, which is a small space filled with small coal, and intended for the reception and reduction of oxides of lead and zinc, which are blown into it; this apparatus is called *zincstuhl*, and it is charged with coal by the opening *dd*.

This mixture yields:—

1. From 2 cwts.  $47\frac{1}{2}$  lbs. to 3 cwts.  $57\frac{1}{2}$  lbs. of **Raw Lead**, containing about 2 ounces of silver per cwt. This becomes cupelled, and the resulting silver, after having been converted under the muffle into fine silver, is treated with sulphuric acid for the extraction of its gold; the litharge is reduced to lead, the scum smelted to hard lead, raw lead, and cupriferos matt.

2. From  $1\frac{1}{4}$  to 6 cwts. of **Lead Matt**. The following analysis, by Ulrich, which may be expressed by the formula  $(PbS, ZnS) 3(Fe_2S, Cu_2S)$

shows its composition:—

Lead . . . . .	8.64
Iron . . . . .	44.34
Copper . . . . .	17.43
Tin . . . . .	7.76
Arsenic . . . . .	2.19
Sulphur . . . . .	19.64

It is either, after properly roasting, worked till it is so cupriferos that it may be treated for copper, or, having been three times roasted, it is mixed with siliceous schlich slags, and worked for the production of raw lead and copper matt.

3. From 0.5 to 5 lbs. of **Zinc**, which is freed from lead by repeated meltings.

4. **Zinciferous Soot**, used for the production of metallic zinc and chloride of zinc.

The following analyses of this soot, by Ahrend, show its composition :—

ZnO . . . . .	80.29	ZnO . . . . .	71.52
PbO . . . . .	8.27	PbO . . . . .	4.80
CuO . . . . .	0.23	Fe <sub>2</sub> O <sub>3</sub> . . . . .	5.06
Fe <sub>2</sub> O <sub>3</sub> . . . . .	5.06	CuO . . . . .	0.23
Al <sub>2</sub> O <sub>3</sub> . . . . .	0.35	ZnO, SO <sub>3</sub> . . . . .	0.56
CaO . . . . .	trace	ZnO, SiO <sub>3</sub> . . . . .	2.66
SiO <sub>3</sub> . . . . .	1.42	ZnO, CO <sub>2</sub> . . . . .	0.65
CO <sub>2</sub> . . . . .	0.23	ZnS . . . . .	8.19
SO <sub>3</sub> . . . . .	0.28	PbS . . . . .	3.72
S . . . . .	3.21	Al <sub>2</sub> O <sub>3</sub> . . . . .	0.35

5. About 27 cwts. of Slags, which are thrown aside. Their composition may be expressed by the formula



An analysis of them by Ulrich gives the following :—

SiO <sub>3</sub> . . . . .	27.66
Al <sub>2</sub> O <sub>3</sub> . . . . .	6.00
FeO . . . . .	50.30
MnO . . . . .	trace
CaO . . . . .	7.72
MgO . . . . .	1.90
PbO . . . . .	2.13
ZnO . . . . .	3.5
CuO . . . . .	trace
S . . . . .	2.23

6. Lead Speiss ; less is formed at the ore smelting than at the matt smelting, and it is worked for the extraction of its silver and copper, and for the production of a concentrated cobalt and nickel speiss. Analyses of different speiss of these works show their composition to be as follows :—

Cu . . . . .	29.94	26.42
Pb . . . . .	3.95	2.91
Fe . . . . .	23.39	23.10
Zn . . . . .	0.91	0.27
Ni . . . . .	1.05	trace
Co . . . . .	4.12	0.75
Bi . . . . .	0.19	—
Cd . . . . .	0.08	—
Sb . . . . .	32.90	36.29
As . . . . .	0.92	7.52
S . . . . .	1.47	5.48

Each mixture requires 740 lbs. of charcoal for smelting, and 1,782 lbs. of coke. The furnaces, using 136 cubic feet air per minute, make operations of 8 or 10 days, during which time 16 mixtures are worked. A smaller yield of lead and an impurer smelting took place when hot blast was used; the saving in fuel was very small.

In the year 1861, those works produced 6,073 cwts. of refined lead, 3,052 cwts. of litharge, and 108 cwts. of zinc (B. u. h. Ztg., 1862, p. 106).

At Fahlun,\* in Sweden, an argentiferous galena,† in which iron and copper pyrites are disseminated, is worked; the ore contains from 6 to 10 lbs. of lead, 2 to 3 lbs. of copper,  $\frac{1}{4}$ th ounce of silver, and 60 to 70 lbs. of pyrites per cwt. It is roasted in mounds from 14 to 18 feet long, 10 to 12 feet wide, and 4 to 6 feet high. The roasted ores are worked in admixture with the proper fluxes, in sump furnaces 18 feet high, and they yield:—

1. **Raw Lead** with  $4\frac{1}{2}$  to 6 ounces of silver per cwt.; the fine silver resulting from it contains from 4 to 6 grains of gold per mark, which is extracted by sulphuric acid.

2. **Raw Matt** containing 6 or 8 lbs. of copper, and about 1 ounce of silver per cwt.; it is roasted and smelted for the production of copper matt, from which copper and silver are extracted.

### Illustrations of Working Ores rich in Lead and associated with Foreign Sulphides and Earths.

Smelting process at Przibram.‡ The quality of the ore has before been mentioned. In the first half of the year 1861, the total quantity of ore brought to the smelting works (41,426 cwts., with 13,698 lbs. of silver, and 18,190 cwts. of lead) contained, on an average, 0.330 lb. of silver, and 43.90 lbs. of lead per cwt.; 16.812 per cent of these were rich ores,

\* ERDMANN, Journal f. ök. u. technische, Chemie, vi., 179. Brgwkfd., xi., 604. RUSSEGER'S Reisen, iv., 641. B. u. h. Ztg., 1859, p. 93.

† COTTA, Erzlagerstätten, ii., 525. B. u. h. Ztg., 1855, p. 37; 1861, p. 195.

‡ Annales des mines, 1842, l., 27. WEHRLE'S Hüttenkunde, ii., 253. Oesterr. Zeitschrift, 1853, p. 215; 1854, p. 283, 321; 1856, p. 322; 1857, p. 265. B. u. h. Ztg., 1843, p. 801; 1850, p. 438.



containing 0·579 lb. silver, and 72·66 lbs. lead per cwt., and were worked by the precipitation process. 50·729 per cent, in form of coarse grains, contained 0·309 lb. of silver, and 40·89 lbs. of lead; and 32·459 per cent of pounded ore (schlich) contained 0·325 lb. of silver, and 33·72 lbs. of lead. The poor ore, when in the form of small fragments, contains 0·321 per cent of silver, 41·25 per cent of lead, 13·53 per cent of zinc, 12·20 per cent of peroxide of iron, and 16·40 per cent of silica; and when in the form of slime and schlich, 0·205 per cent of silver, 27½ per cent of lead, 9·22 per cent of zinc, 18·00 per cent of peroxide of iron, and 28·10 per cent of silica. The former contains 45½ per cent of sulphides, and the latter 29 per cent.

The different lots intended for roasting are spread out one upon the other, and are made use of whilst so combined.

English roasting reverberatory furnaces and double reverberatory furnaces are used for roasting. In the former charges of 20 cwts. are employed, which are stirred continually, and turned three or four times. At the end of the process (after about eight hours) the temperature is so much increased that the roasting mass begins to cake. The furnaces with two hearths are charged with from thirteen to fifteen cwts. of ore, which are spread out about two inches high upon the hearth, and kept four hours in the upper hearth, and then four hours in the lower one.

The roasted ores are chiefly smelted in cupola furnaces, with two tuyeres, of Vogl's construction. The tuyeres have an inclination of from nine to eleven degrees, and the sump lies at its deepest point seventeen inches beneath the tuyeres. These high cupola furnaces give a greater production and a better yield, and less loss of metal by volatilisation and scorification, and require less fuel than the lower cupola furnaces, which were formerly exclusively used, and are still occasionally to be met with.

The mixtures for both kinds of furnace are as follows:—

*Mixture for the high cupola furnaces:* 50 cwts. of ore, 4 cwts. of furnace ends, 2 cwts. of rich litharge, 2 cwts. of scum, 4 cwts. of old hearth, 4 cwts. of iron, and 24 cwts. of iron refinery cinders. 49 cwts. 35 lbs. of ore are smelted

in 24 hours, yielding 17 cwts. 86 lbs. of raw lead, at a consumption of 55 cubic feet of coal per 5 tons. of ore. *Mixture for the lower furnaces*: 25 cwts. of ore, 3 cwts. of furnace ends, 1 cwt. of rich litharge, 2 cwts. of old hearth, 175 cwts. of iron, and 10 cwts. of iron refinery cinders. 35 cwts. of ore are smelted in 24 hours, yielding 10 cwts. 18 lbs. of raw lead, at a consumption of 750 cubic feet of coal per 5 tons. of ore.

The cost for smelting in the high furnaces is 2s. per cwt. less than in the low furnaces.

Smelting process at Freiberg. The smelting processes formerly used (*vide* Lampadius, "Hüttenkunde," Jar's "metallurgische Reise" iii., 663. Winkler, "die Freiburger Schmelzprozesse." Freiberg, 1837, &c.) have been considerably modified in the course of time; some are altogether abandoned, and new ones introduced. The most extensive experiments have been made to discover a means of obviating the deleterious influence of the lead smoke. Foreign silver ores are bought and worked together with the ores raised from the mines in the neighbourhood of Freiberg. The two smelting works situated near Freiberg are called the Muldner and the Halsbrückner Works; they buy the ores from the mines in the Erzgebirge at a fixed rate. According to v. Dechen,\* the Erzgebirge contains 1848 veins, in which silver ore occurs (native silver, antimonial silver, silver glance, horn silver, &c.), in 181 of them silver ores are predominant, in 403 of them silver and lead ores, in 465 silver, lead, and copper ores, and in 849 silver, cobalt, and lead ores. The veins in the neighbourhood of Freiberg yield 19-20ths of the whole production of silver of the Erzgebirge.

Those ores in metallurgical relation are divided thus:—

1. **Lead Ores**; galena associated with iron pyrites, arsenical pyrites, zinc blende and earthy substances (chiefly quartz, calc spar, brown spar, and baryta). Ores containing from 15 to 29 per cent of lead are called lead ores; those containing from 30 per cent and upwards, glance. The lead

\* v. COTTA, Erzlagerstätten, ii., 4. B. u. h. Ztg., 1866, p. 301; 1866, p. 214. v. DECHEN, Statistic des nörd. u. zollv. Deutschlands i., 758.

ores contain, on an average, 40 lbs. of lead and 0·15 lbs. of silver per cwt., and they amount to half the quantity (25,000 tons) worked at the smelting works.

2. **Earthy Silver Ores.**—These are chiefly earths containing disseminated silver ores; sometimes also iron pyrites and some galena. If the silver they contain exceeds 0·10 lb., they are worked with the lead ores, and if they contain less they are submitted to the raw smelting process in reverberatory furnaces. The amount of silver in these ores sometimes exceeds 2 per cent.

3. **Copper Ores**, with from 1 to 10 per cent, on an average 3 per cent, of copper; if they do not contain more than 6 per cent, they are worked together with the lead ores, on account of their great amount of silver.

4. **Flux Ores**, chiefly iron pyrites, arsenical pyrites, and often a great deal of zinc blende, quartz, calc spar, containing less than 0·03 per cent of silver and some lead and copper. They are converted into raw matt, and then used as fluxes for smelting the lead ores. The first three sorts of ore are worked in the form of schlich; the latter ore is used partly in fragments.

For roasting the ores they are mixed in quantities of 1,500 to 2,000 cwts. containing 50 per cent of glance ore, 30 per cent of lead ores (or 60 per cent of glance and 20 per cent of lead ores), 20 per cent of earthy silver ores, containing more than 0·12 per cent of silver; or copper ores, with the same amount of silver, or furnace ends, of a similar richness; so that the mixture contains, on an average, from 34 to 38 per cent of lead, and 0·15 to 0·18 per cent of silver.

Hungarian furnaces\* and English reverberatory furnaces were formerly used for roasting; but, at present, as the evolved sulphurous acid is used for the production of sulphuric acid, the roasting is conducted in furnaces which are a combination of reverberatory and muffle furnaces; they are represented by Figs. 45, 46, 47, 48, and 49. At Przibram they have been advantageously employed. At the Muldner smelting works 6 of these furnaces lie in 4 parallel rows, one

\* B. u. h. Ztg., 1849, p. 183.

behind another. A channel, *f*, communicating with all the six furnaces, is constructed on the top of each row, and the

www.libtool.com.cn FIG. 45.

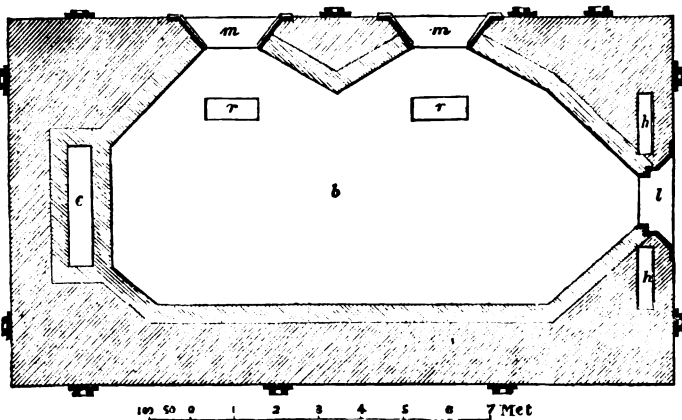

Section through I K.

FIG. 46.

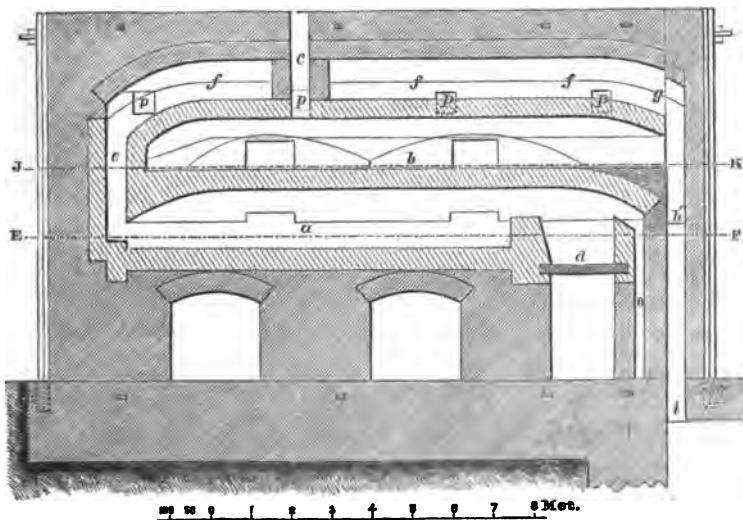

Section through G H.

muffles are separated from it by a brick division, six inches high. The products of combustion are conducted from this channel by the flues *h h*, into the horizontal channel *k*,

K

FIG. 47.

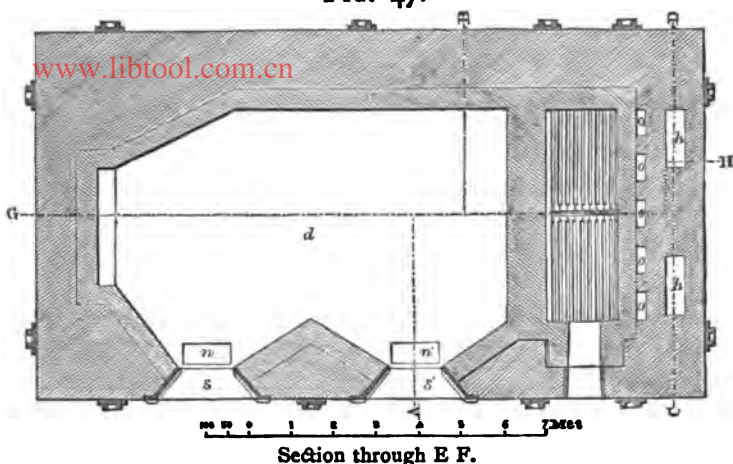

which leads to the chimney. The draught in the channels may be regulated by iron sliding doors. The channel conducting the sulphurous acid from the muffles is made of considerable length, in order to allow the deposition of the arsenious acid and of the particles of ore dust which are mechanically carried away.

FIG. 48.

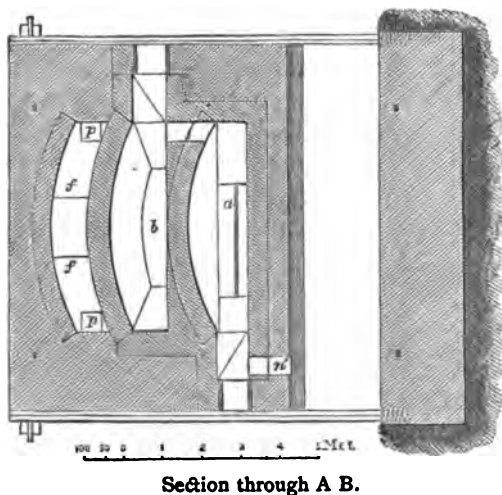

Quantities of 10 cwts. of ore are roasted on the upper

FIG. 49.

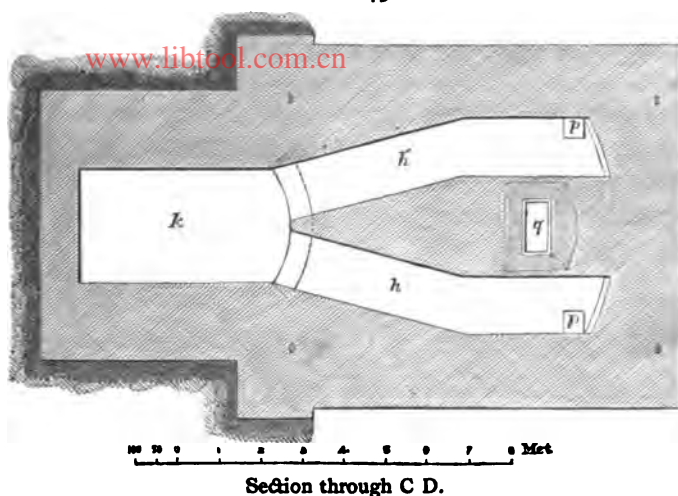

hearth for four hours each at a dull red heat, and afterwards for four hours longer on the lower hearth at a gradually increasing temperature, so that the ore begins to cake. Each lot of ore must be assayed, in order that the roasted products may not contain more than 4.5 per cent of sulphur. If the ores do not contain a sufficient quantity of pyrites, they are mixed up with pounded raw matt; this prolongs the roasting process by one hour. Well roasted ore has a blackish, earthy appearance. Each furnace hearth is attended to by one workman who works eight hours at a time, and about four cwts. of coal are consumed in the roasting of one lot of ore. The roasted lead ore is mixed with roasted raw matt in quantities of 30 to 50 per cent of its own weight, 5 to 8 per cent of burned lime\* or fluor spar, and impure slags from the smelting process, in the proportion of  $1\frac{1}{4}$  to  $1\frac{1}{2}$  cwts. of slags to 1 cwt. ore, in the following manner:—

First spread out 20 cwts. of raw matt; place upon it 60 cwts. of roasted lead ore; upon this, poor lead ores richer in silver, and unroasted; then  $2\frac{1}{2}$  cwts. of lime or fluor spar; and, finally, the slags. The burned lime contributes to a better yield of lead, and to the formation of matt and slags poorer in lead.

\* Jahrbuch f. d. Sächs. Berg- und Hüttenmann, 1845 p. 55; 1846, p. III.

If the mixture is rich in silver, shortly before the raw lead is tapped, lead fluxes are added at the corners of the back wall, 3 cwts. of litharge or 4 cwts. of hearth being added in 24 hours to each furnace. This manner of charging is said to be more effective for extracting silver than distributing the lead fluxes over the slags.

The smelting process is carried on in Wellner's double furnaces, represented by Figs. 50, 51, 52, and 53.

FIG. 50.

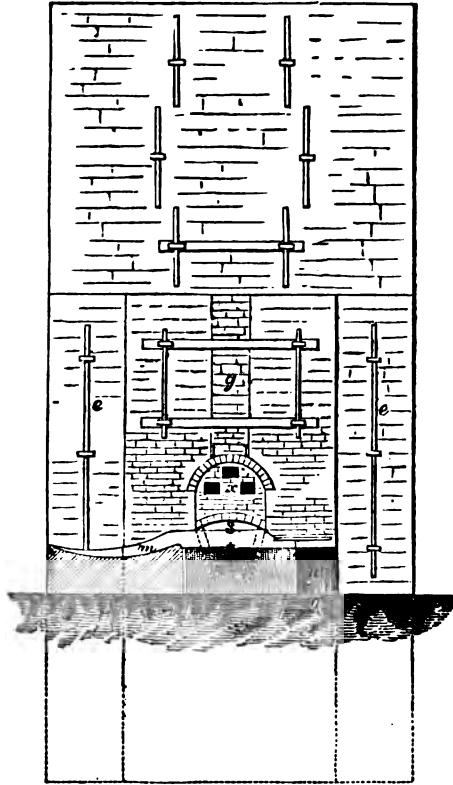

These furnaces are built of gneiss and fire-bricks. *a* and *b* are drains in the foundation *c*; *d* is the back wall; *e*, the rough walling; *f*, coating of fire-bricks; *g*, front wall; *h*, shafts; *i*, hearth; *k*, tuyeres; *l*, tuyere arch; *m*, slag duct; *o*, sole formed of slags; *p*, sole of loam; *q*, sole bottom,



FIG. 51.

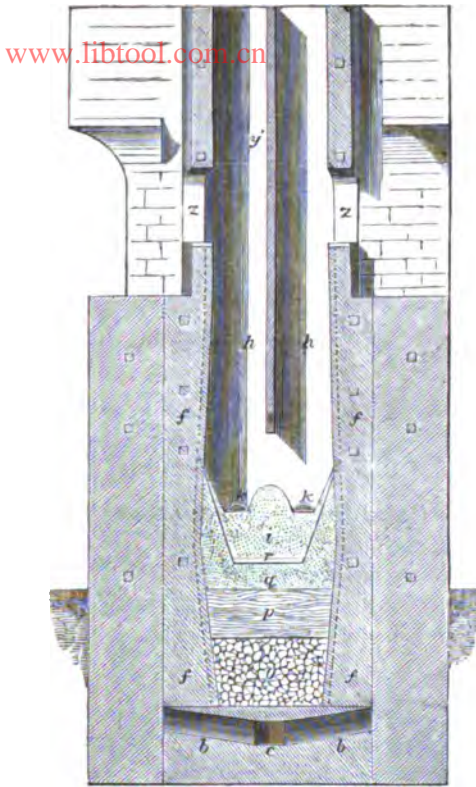

composed of a mixture of coke dust and fire clay ; *r*, sump ; *s*, wall ; *t*, fore hearth ; *u*, channel for tapping off the metal ; *v*, outside basin for receiving the metal ; *w*, breast wall ; *x*, working holes ; *y*, division wall ; and *z*, openings for charging the furnace. The tuyeres have a slight inclination, and the slope of the front wall is from 12 or 15 inches. At the Muldner smelting works, 6 double furnaces are connected by means of a channel which is built at the top for the purpose of collecting the metallic fume and ore dust. The channel leads into a chimney furnished with one division wall for each 3 furnaces. The hearths of the latter are constructed as in the sump furnaces, and they are composed of 3 parts by weight of loam, and 2 parts of coke dust.



Coke from the Saxony district is used for fuel, and during the smelting the mouth of the furnace is kept free from flame; a nose of from 4 to 6 inches long is used, and the pressure of blast is kept between 1·8 and 2·2 lines of mer-

FIG. 52.

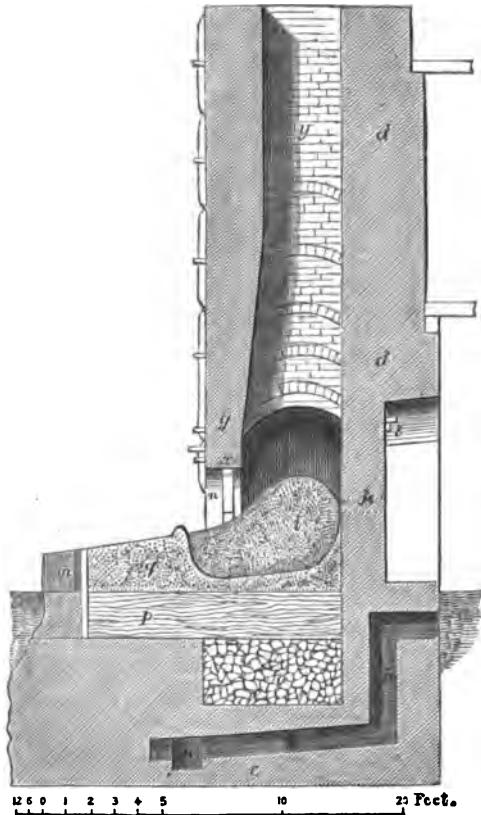

cury. The section of the tuyere being equal to 5·2 square inches, the furnace receives from 185 to 213 cubic feet of cold blast per minute. If the process proceeds in a normal manner, 2 and 4 barrows of mixture of 57 lbs. each are charged alternately with from 19 to 22 lbs. of coke. If the nose is too long, 2 barrows of the mixture are charged in succession, and if too short, 4 barrows are charged successively

FIG. 53.

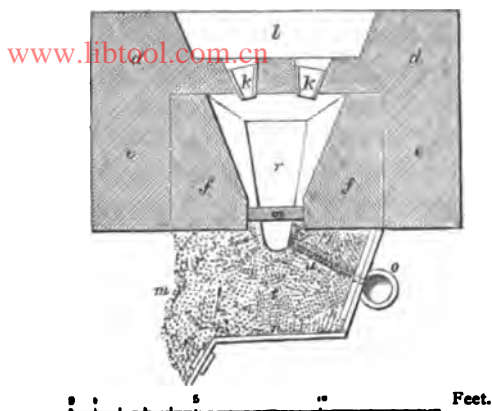

without altering the charge of coke ; but, in the latter case, the charge is begun with some barrows of mixture. In 24 hours the lead is tapped off 4 times, each furnace having been charged with about 60 cwts. of ore, 20 cwts. of raw matt, and from 90 to 100 cwts. of lead slags ; consuming from 24 to 27 cwts. of coke. Three workmen attend to the furnace, and an operation lasts 20 weeks.

The products resulting in 24 hours are on an average—

1. **Raw Lead**, 16 cwts., which contain from 0·50 to 0·60 lb. of silver per cwt. This is refined in reverberatory furnaces, and treated according to Pattinson's process, so as to concentrate the amount of silver into half the original quantity. The poor lead is sold, the rich lead cupelled, and the resulting silver refined to fine silver.

Raw lead from Halsbrücker smelting works contained; according to Richter, 96·69 per cent of lead, 0·53 per cent of silver, 0·20 per cent of copper, 0·06 per cent of iron, 1·30 per cent of arsenic, and 0·71 per cent of sulphur. Refined raw lead contained 98·46 per cent of lead, 0·64 per cent of silver, 0·22 per cent of copper, 0·05 per cent of iron, 0·14 per cent of arsenic, and 0·3 per cent of sulphur.

2. **Lead matt**, 8 cwts., which contain 0·20 per cent of silver, 20 lbs. of lead, and 10 lbs. of copper.

Matt from the smelting of roasted ores contained 25·130

per cent of lead, 33·120 per cent of iron, 12·100 per cent of copper, 0·201 per cent of silver, 2·450 per cent of arsenic, 4·753 per cent of antimony, and 19·526 per cent of sulphur.

Re-smelted matt contained 20·250 per cent of lead, 27·052 per cent of iron, 27·614 per cent of copper, 0·117 per cent of silver, 1·010 per cent of nickel, 0·231 per cent of tin, 0·650 per cent of arsenic, 1·005 per cent of antimony, and 21·314 of sulphur.

In order to lessen the amount of lead and silver in the matt, it must be re-smelted in a double furnace at the end of each operation, having been first pounded, roasted, and mixed with slags from the same operation, and with hearth ends. 20 cwts. of roasted matt are mixed with about 80 cwts. of these substances, and as the smelting process is very expeditious, in 24 hours the reduced metal is tapped off 8 or 9 times. The following are obtained from this re-smelting process:—

*a. Raw Lead*, which is added to the raw lead from the ore.

*b. Modified Slags*, which are treated like ore slags.

*c. Modified Matt*, which is worked as follows:—A mixture of  $5\frac{1}{2}$  tons of roasted lead matt, 10 to 15 cwts. of the slags of the same process, 20 cwts. of the slags from the reducing process of litharge, and 3 cwts. of fluor spar, and sometimes some copper ores poor in silver, is smelted in a double furnace in 24 hours; the tuyeres are placed perfectly horizontal, and the channel for tapping the metal is put 22 inches beneath the tuyeres. This process lasts for 12 or 14 weeks; from 18 to 20 cwts. of cupriferous lead containing 0·75 per cent of silver, and 30 cwts. of copper matt containing about 30 per cent of copper and 0·18 per cent silver, are produced every 24 hours.

The following is an analysis of the copper matt:

Pb.	Fe.	Cu.	Ag.	<u>Ni. Zn.</u>	S.
24·80	15·20	36·20	0·16	2·64	21·00

This matt is roasted and worked again in double furnaces, producing *matt*, *raw copper*, and *slags* which are worked up again with the lead matt (*vide* Copper). The lead matt slags

are treated like ore slags ; they are worked up in reverberatory furnaces for the production of raw matt, in combination with about one half of roasted flux ores, poor silver and copper ores containing upwards of 3 per cent of copper, and a suitable amount of copper residues. The copper matt from the second smelting is treated partly by Augustin's method for the extraction of its silver, the residues are smelted to raw copper, and being partly roasted are treated with sulphuric acid ; the argentiferous residues are worked up in the lead smelting process, and the lye water is boiled down for the production of a mixed vitriol.

3. **Speiss.** This occurs in thin layers with the matt, from which it is easily separated ; it is composed of arsenical iron, nickel, and cobalt, mixed with sulphides of iron, copper, zinc, and lead. It must be roasted and worked with lead fluxes for the extraction of its silver ; raw lead and lead matt to be worked by the lead matt smelting process, and a speiss rich in cobalt and nickel, to be sold after having been farther refined, are thus produced.

4. **Lead Slags.** 73 cwts. of this are produced from 5 tons of the mixture, containing 5 or 6 lbs. of lead, and about 0·02 lb. of silver per cwt. According to Richter, they are composed as follows (*a* is slag from the Halsbrückner, and *b*, from the Muldner Smelting Works) :—

*a.* 28·14 per cent of silica, 5·78 per cent of alumina, 37·23 per cent of protoxide of iron, 7·68 per cent of lime, 3·87 per cent of sulphide of barium, 0·63 per cent of magnesia, 7·35 per cent of oxide of lead, 7·60 per cent of oxide of tin, 0·50 per cent of copper, and 2·47 per cent of sulphur.

*b.* 27·05 per cent of silica, 6·85 per cent of alumina, 41·21 per cent of protoxide of iron, 8·84 per cent of lime, 0·90 per cent of magnesia, 3·90 per cent of oxide of lead, 8·62 per cent of oxide of tin, 1·00 per cent of oxide of copper, and 3·53 per cent of sulphur.

These slags were formerly re-smelted at the end of each operation, but they are now worked together with flux ores and poor earthy silver ores, by which smelting process the greater part of their metal collects in the matt, whilst the

considerable amount of protoxide of iron they contain acts advantageously in smelting the siliceous ores. The raw matt, being rich in iron and containing valuable metals, is a useful flux in the lead smelting process.

The present mode of working up the lead slags combines the advantages of giving a better yield and of allowing the time which was formerly required for the re-smelting of the slags to be used for the working of a larger quantity of ore.

If impure slags result from the ore smelting, the amount of metal they contain is extracted by the subsequent smelting in reverberatory furnaces, and the yield of the first process may therefore be increased without disadvantage. As the slags are completely worked up, an exact calculation of the cost of the different processes is possible.

The lead slag process allows a decrease of the expensive raw smelting, and an increase of the lead smelting process, as the earthy silver ores which were formerly used in raw smelting are more extensively worked in lead smelting.

**The Raw Smelting Process** comprises the following manipulations:—

**a. Roasting the Flux Ores.** As part of the flux ores contain much blende, they are roasted either in an English reverberatory furnace or in a double furnace. In the former, 30 cwts. are roasted in 8 hours, in order to avoid an impure smelting, and to produce less matt with a suitable amount of metal; the reverberatory furnaces, constructed like gas furnaces, consume 10 cwts. of coal and 9 cwts. of cinders, and the English furnaces with a direct firing, 18 cwts. of coal in 24 hours. Two workmen attend to the furnace in shifts of 8 hours. The roasted mass must not contain more than 4·5 per cent of sulphur.

**b. The Smelting of Raw Matt** is conducted in reverberatory furnaces, as represented by Figs. 54 and 55; *a*, is the foundation; *b*, the cast iron plates; *c*, the pillars; *d*, mantle; *e*, fire-place; *f*, grate, consisting of 13 grate bars each 2 inches square; *g*, opening for charging the fuel, 16 inches high; *h*, fire-bridge; *i*, channel for cooling; *k*, refractory coating, consisting of 3 parts quartz and 1 part clay, 12 inches high;

FIG. 54.

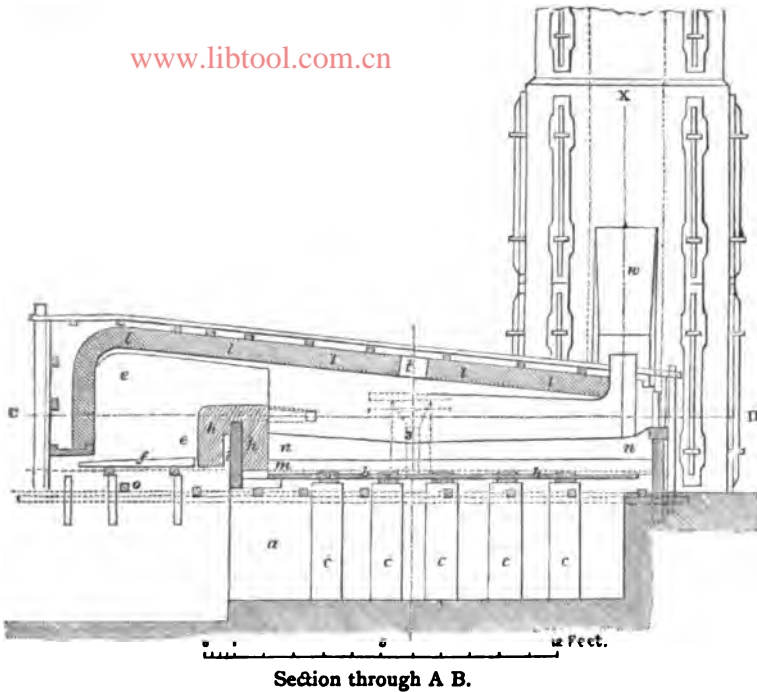

*l*, arched roof of the furnace; *m*, bottom made of bricks; *n*, bottom formed of quartz and clay; *o*, channels for the admission of air; *p*, working door, 12 inches square; *q* and *r*, side openings; *s*, tap opening; *t*, opening for charging the furnace; *u*, support for the tools, coated with a lubricating mixture of oil and graphite; *v*, support for tools used for lifting the grate; *w*, flue; *x*, chimney, 66 feet high. The slope of the hearth from the fire-bridge to the tap-hole, *s*, is from 5 to 6 inches. The opening in the arch for the flue is of trapezoidal section, 11 inches broad, 2 feet 8 inches long on the back, and 14 inches long on the front towards the working door.

The body of the furnace, *n*, consisting of a refractory mass, is covered with a mixture of 5 parts of quartz and 1 part of raw slag, and the hearth is formed by burning it; then the first charge only of lead slags is given, that the hearth may

FIG. 55.

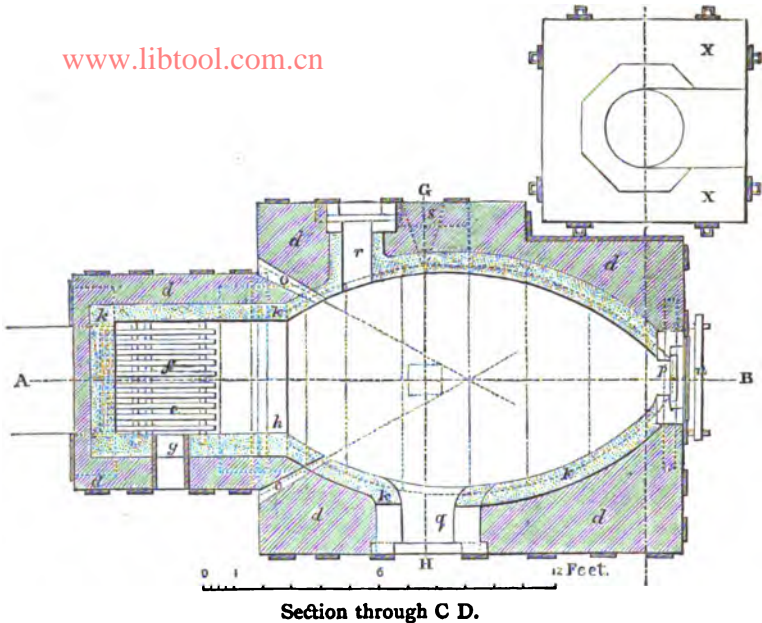

attain greater solidity. By means of the movable charging funnel, charges of 20 cwts. of lead slags, 5 cwts. of raw and 5 cwts. of roasted flux ores (or sometimes instead of the roasted ore, pyrites previously burned in heaps or in the manufacture of sulphuric acid), are now added in such a way that the ore lies on the top of the slags; 1 or 2 cwts. of quartz are also added if necessary. The roasting mass is then spread out upon the hearth in such a manner that the layer is somewhat higher near the fire-bridge, and is smelted in  $2\frac{1}{2}$  hours, when the grate is cleared and the fire stirred for about half an hour; the atmospheric air is excluded as much as possible during the whole process. The liquid mass is then stirred and again heated by a fierce fire for about a quarter of an hour, whilst the working door is kept closed; then the slag is drawn out from the working door. The slag first runs into moulds of sand upon the floor of the smelting house, and thence into moulds of cast iron, 2 feet long and 1 foot broad and high. By letting part of the new charge



pass over the hearth, the slags accumulate against the working door, and thus they may be more perfectly removed. After having treated two more charges in a similar manner (two or three times in 24 hours), the raw matt produced is tapped off, by s, into iron moulds 4 feet long, 18 inches broad, and 10 inches deep; the tap-hole is then closed, the fire-bridge and hearth repaired with a mass consisting of five parts of refractory clay, and two parts of quartz, and the smelting process is re-commenced. In operations of about twelve months, in twenty-four hours about  $5\frac{1}{4}$  tons of slate coal are consumed for the production of—

a. 2 tons of **Raw Matt**, containing from 0'15 to 0'20 lb. of silver, 8 or 10 lbs. of lead, and 4 or 5 lbs. of copper per cwt.; if the matt contains a greater amount of zinc blende, it has a granular, laminated, black fracture of some lustre, and possesses a certain solidity and density, in consequence of which it is difficult both to roast and to fuse. Some powdered coke and fluor spar were formerly added before the tapping off of the matt, with very good effect, the coke then reducing some peroxide of iron from the roasted flux ores, and the reduced iron extracting some zinc which became volatilised; the fluor spar assisted the formation of slags. But as this treatment both prolonged the smelting process and caused a greater consumption of fuel, also, as the slag became pasty, rendering the separation of the matt more difficult, and as greater loss of lead and silver took place, it was abandoned, and the attainment of a purer reverberatory furnace matt has been attempted by a more perfect roasting of the flux ores. Sometimes the raw matt has a certain amount of slag and per- and protoxide of iron mixed up with it.

The reverberatory furnace raw matt is composed, according to an analysis by Richter, of 53'81 per cent of iron, 7'65 per cent of tin, 7'35 per cent of lead, 3'87 per cent of copper, 0'84 per cent of arsenic and antimony, 23'43 per cent of sulphur, and 2'11 per cent of silica.

These matts are compounds of  $\text{FeS}$  with more or less  $\text{Fe}_2\text{S}$  and  $\text{PbS}$ ,  $\text{Cu}_2\text{S}$ ,  $\text{ZnS}$  and  $\text{AgS}$ , and are sometimes mixed with  $(\text{Fe}, \text{Ni}, \text{Co})_4 \text{As}$ .



The matt must be crushed into pieces the size of the fist, and roasted in mounds before it is in a condition to be used. Well roasted raw matt has a greyish black, dull appearance. [www.libtool.com.cn](http://www.libtool.com.cn)

*b. Furnace Hearth.*—This is worked up in the lead smelting process.

*c. Slags* containing on an average 1 lb. of lead and 0.002 lb. of silver per cwt. These are mixtures of mono- and bi-silicates. They are either thrown away or are moulded into bricks of 3 cwts. each for building purposes.

Such a slag from the Halsbrückner smelting works was, according to Richter, composed of 36.04 per cent of silica, 5.38 per cent of alumina, 42.60 per cent of protoxide of iron, 6.29 per cent of lime, 1.71 per cent of oxides of magnesium and manganese, 0.24 per cent of sub-oxide of copper, 1.34 per cent of oxide of lead, 4.66 per cent of oxide of tin, and 1.47 per cent of sulphur.

In the year 1859, 23,220 tons of ores (amongst them 130 tons of foreign ores), containing on an average 0.1291 lb. of silver per cwt. were worked at the smelting works near Freiberg. They yielded 23,565 lbs. of fine gold, 60,546.0070 lbs. of fine silver, 15,782.2824 cwts. of refined copper, 297 cwts. of copper vitriol, 32 cwts. of mixed vitriol, 27,475 cwts. of assay lead, 51,521.76 cwts. of soft lead, 4,120.6 cwts. of hard lead, 4,900.4 cwts. of red litharge, 7,697.04 cwts. of yellow litharge, 7,095.58 cwts. of black litharge, and 3,115 cwts. of lead smoke. In the manufacture of sulphuric acid there were produced: 12,367.2 cwts. of sulphuric acid, 887.71 cwts. of iron vitriol, 8.35 cwts. of arsenical sulphur, 2,553.35 cwts. of raw chamber acid, and 3.40 cwts. of lead pan acid.

At the silver smelting works in Lower Hungary the ores used are silver ores (silver glance, and more rarely red silver ore and native silver) and lead ores. The matrices consist of quartz, clay, limestone, zinc blende, manganese, spar, iron pyrites containing gold and silver, copper pyrites very seldom, and in some cases sulphide of antimony. There is more quartz than lime.

The composition of the ores is shown by the following analysis, made in the laboratory at Schemnitz:—

*Poor lead ores* from the Ferdinands mine contained 2·86 per cent of copper, 4·10 per cent of lead, 0·0003835 per cent of gold, 0·0557215 per cent of silver, 3·14 per cent of tin, 6·40 per cent of iron, 4·33 per cent of manganese, 0·34 per cent of antimony, 5·21 per cent of sulphur, 60·87 per cent of silica, 5·69 per cent of alumina, 3·81 per cent of lime, 0·90 per cent of magnesia, 0·04 per cent of soda, and 0·19 per cent of potash, with a trace of arsenic.

*Schlich* from the mines of Segengottes and Schmidterinn contained 0·9 per cent of copper, 0·7 per cent of lead, 0·00142 per cent of gold, 0·02467 per cent of silver, 8·3 per cent of tin, 20·2 per cent of iron, 8·3 per cent of manganese, 11·7 per cent of sulphur, 36·7 per cent of silica, 5·1 per cent of alumina, 5·2 per cent of magnesia, and traces of arsenic and lime. *Mixed pyritic schlich* contained 1·0 per cent of copper, 0·6 per cent of lead, 0·000832 per cent of gold, 0·081508 per cent of silver, 0·8 per cent of tin, 25 per cent of iron, 4·7 per cent of manganese, 18·7 per cent of sulphur, 31·9 per cent of silica, 12·6 per cent of alumina, 3·2 per cent of lime, 1·3 per cent of magnesia, and a trace of arsenic.

*Schlich from pyrites* contained 15 to 39 per cent of silica, 16 to 83 per cent of sulphide of iron, 0·8 to 14 per cent of peroxide of iron, 3 to 6 per cent of oxide of lead, 0·12 to 1·5 per cent of oxide of copper, 0·5 to 37 per cent of sulphide of zinc, 48 to 66 per cent of sulphides for forming matt, and from 0·006 to 0·035 lb. of auriferous silver, 1 lb. of which contains from 0·015 to 0·4 lb. of gold.

The silver ores and silver schlich are divided according to whether they contain sulphides or are free from them, and again according to their amount of auriferous silver; that is to say, into those containing from 0·002 to 0·1 lb., those containing from 0·1 to 0·2 lb., and those containing from 0·21 lb. per cwt. and upwards. The amount of gold in these ores is from 0·006 to 0·05 lb. per pound of auriferous silver.

Lead ores and schlich contain on an average 44 per cent of lead, 0·0352317 per cent of silver, and 0·0000083 per cent

of gold, and 0.010 to 0.180 lb. gold per lb. of auriferous silver. They are worked in the proportion of 41 parts to 59 of the other ores.

The lead ores are principally used for extracting the silver from the silver ores (*vide* Silver); the raw lead resulting from this process is cupelled, and the argentiferous copper matt is worked at Tajowa.

Those lead ores which are not worked for the production of argentiferous lead, are submitted to the following ordinary lead smelting process:—

The lead ores and lead schlich are roasted in a reverberatory furnace at a low temperature, combined with some schlich rich in silver. The hearth of that furnace is of a peculiar form, consisting of two parts,—that near the grate measuring  $5\frac{1}{2}$  feet by  $6\frac{1}{2}$  feet, and the other part, forming the continuation of the first one towards the flue,  $9\frac{1}{2}$  feet long and 5 feet broad. The furnace is of the usual construction. On the top of the furnaces are constructed channels for retaining the ore dust which is carried away by the draught. Lots of from 500 to 560 lbs. of ore are first roasted at a very low temperature on part of the hearth near the flue, for 2 or 3 hours, and afterwards on the hearth near the grate for half an hour or 1 hour, at an increased temperature.

The smelting of the roasted ores is performed with ore slags in sump furnaces\* 18 feet high, and furnished with 2 tuyeres.

From 8 to 10 tons of ore and schlich are worked each week, consuming about 1,200 cubic feet of charcoal. The yield is from 88 to 90 per cent of raw lead, with 0.3 to 0.5 lb. of auriferous silver, 8 to 14 lbs. of lead, and 2 to 3 lbs. of copper; some furnace ends; slags containing 0.0005 to 0.002 lbs. of silver, and  $\frac{1}{2}$  to  $1\frac{1}{4}$  lb. of lead, if the process goes on properly.

At Holzappel, in Nassau, the galena is associated with zinc blende, white lead ore, copper pyrites, and fallow ore, and with a great proportion of sparry iron ore and quartz, and

\* Oesterr. Ztschrift, 1857, p. 332.

with less calc spar, iron pyrites, and antimonial and arsenical compounds. After a most perfect dressing of the ore, and as complete a separation as possible of the saleable zinc blende, the ores are finely pounded by rollers, and mixed with the schlich and finer fragments, so as to form a mixture of 65 to 68 per cent of galena, 15 to 18 per cent of zinc blende, 15 to 18 per cent of sparry iron ore and quartz, together with a small amount of copper pyrites.

Reverberatory furnaces are used for roasting the ores; these furnaces have hearths 20 to 25 feet long and 6 to 7 feet broad, and are furnished with 5 working doors. In 24 hours 3 tons of ore are roasted, in portions of  $\frac{3}{4}$  ton every 6 hours, which are gradually moved upwards from the charging opening to the fire-bridge. The loss in this process amounts to 9 or 10 per cent; taking into consideration  $\frac{1}{2}$  per cent of virgin lead, which is extracted during roasting, the roasting mass contains about 4 per cent of sulphur, and from 54 to 55 per cent of lead.

A mixture of  $37\frac{1}{2}$  cwts. is formed of 15 cwts. of roasted ore, 1 cwt. of brown and white lead ore, 150 lbs. of refinery hearth, 100 lbs. of metallic fume, 12 cwts. of lead slags, 3 cwts. of iron refinery cinders, 1 cwt. of sparry iron ore containing galena from the dressing tables, 2 cwts. of limestone, 1 cwt. of brown iron ore containing manganese and white lead ore, and 25 lbs. of iron in the form of scraps and washings; the amount of this last is increased if raw ores are smelted instead of roasted ores. In 24 hours from 4 to 5 of these mixtures are charged, each with 5 cwts. of coke. Vogl's sump furnaces, 13 feet high, are used, in which each operation lasts 4 weeks. The smelting process is carried on with a nose from 4 to 5 inches long. One furnace yields daily from  $2\frac{1}{4}$  to  $2\frac{1}{2}$  tons of raw lead, containing 2 ounces of silver. The slags contain from  $\frac{3}{4}$  to 1 per cent of lead; Vogl's furnaces, 18 or 20 feet high, and furnished with two tuyeres, have been used of late.

At Lohe, Müsen, and Rothenbach, the following ores from the Stahlberg are worked:—Galena, with disseminated fallow ore, zinc blende, and copper pyrites, containing from 50

L

to 60 per cent of lead, and from 2 to  $2\frac{1}{2}$  ounces of silver; fallow ore, associated with sparry iron ore, containing from  $2\frac{1}{2}$  to 3 ounces of silver; and copper pyrites with more or less silver. The chief gangues are sparry iron ore, quartz, and baryta; zinc blende, iron pyrites, nickel and antimonial ore, white lead ore, malachite, &c., occur in smaller quantities.

At Müsen and Rothenbach the lead ores are roasted in pyramidal heaps of 16 to 18 feet in the base, and from 3 to 5 feet high, in quantities of 60 tons, upon a layer of wood, coal, and coke rubbish, 8 inches high. 3 or 4 layers of ore from 10 to 12 inches deep are placed alternately with layers of charcoal 4 inches thick. Ores in the form of schlich and coarser grains are mixed with lime, and put in separate layers upon the ores in fragments. By means of bundles of wood a flue is formed in the middle of the heap. The heap burns out in about  $3\frac{1}{2}$  or 4 weeks, or during winter time in from 4 to 6 weeks, and then a second firing is given for about 4 weeks; the roasted ores contain from  $\frac{1}{4}$  to 1 ounce of silver, and from 40 to 55 lbs. of lead per cwt. The cost of roasting 5 tons of ore is about £1 8s. 5d.

Sandmann's analysis shows the fallow ores to be composed of 38.41 per cent of copper, 2.29 per cent of iron, 6.50 per cent of tin, 0.69 per cent of silver, 4.98 per cent of arsenic, 19.71 per cent of antimony, 25.52 per cent of sulphur, 0.36 per cent of silica, and a trace of nickel. They are roasted in mounds from 13 to 17 feet long, 8 feet broad, and  $5\frac{1}{2}$  feet high; the foundation is of fuel, and the intermediate layers are placed as when roasting in heaps. A space 3 inches wide is left on the surrounding walls, which is filled up with wood; two perpendicular flues are made in the middle of the mound. From 20 to 25 tons of ore are roasted in from 2 to 5 weeks, according to the amount of pyrites they contain; the cost for roasting 5 tons of fallow ore is about £1 7s.; the roasting of 5 tons of copper ore costs 12s. 6d.

At the Müsener smelting works the mixture consists of 10 cwts. of twice roasted lead ore,  $2\frac{1}{2}$  cwts. of once roasted fallow ore, 0.5 cwt. of iron, 0.4 cwt. of iron refinery cinders, and  $13\frac{1}{2}$  cwts. of lead slags; that at Rothenbach, where the

ores contain a larger quantity of baryta, consists of 10 cwts. of twice roasted lead ore, 6 cwts. of once roasted fallow ore, 1 cwt. of iron, 15 cwts. of lead slags, and  $1\frac{1}{2}$  cwts. of ferruginous copper pyrites. When a great proportion of fallow ore is to be worked, the following mixture is used:—10 cwts. of twice roasted lead ore, 10 cwts. of once roasted fallow ore, 1 cwt. of iron, 15 cwts. of lead slags.

The proportion of the produce in lead and matt, of the first mixture is as 5 to 2, of the second as 2 to 1, and of the last as 7 to 8.

The refinery cinders contain from 25 to 30 per cent of silica and 67 to 70 per cent FeO (= 47 to 55 per cent of iron); the iron used contains 90 per cent of metal: therefore  $1\frac{1}{2}$  cwts. of cinders are equal to 1 cwt. of iron; 1 cwt. of the latter costs 3s., and 1 cwt. refinery cinders 9d.

The smelting of the ores, with coke for fuel, is performed either in a low cupola furnace from 6 to 8 feet high above the tuyere, or in very low cupola furnaces, 4 to  $4\frac{1}{2}$  feet high above the tuyeres. The latter furnaces are charged with 270 to 300 lbs. of mixture upon 25 lbs. of coke; thus 12 lbs. of mixture are smelted by 1 lb. of coke. The higher furnaces are charged with 750 lbs. of mixture upon 50 lbs. of coke, or 15 lbs. mixture to each pound of coke.

In this smelting are produced—

*a. Raw Lead*, containing from 1 to  $1\frac{1}{2}$  per cent of copper, 3 to 4 per cent of antimony and arsenic, besides some particles of matt; the amount of silver varies from 3 to 6, or even 7 ounces per cwt.

*b. Lead Matt*, containing about 35 per cent of lead, 5 or 6 per cent of antimony and arsenic, 6 or 8 per cent of copper, and 2 or 3 ounces of silver. The amount of silver in raw lead stands in proportion to that in the matt as 2 to 3; thus the raw lead is  $1\frac{1}{2}$  times as rich as the matt.

*c. Speiss*, sometimes.

*d. Metallic Fume*, containing from 30 to 40 per cent of lead, and about  $\frac{1}{2}$  an ounce of silver.

*e. Lead Slags*.—If these are pure mono-silicates, they contain from  $1\frac{1}{2}$  to 2, and sometimes 3 per cent of lead.

The process for working up the lead matt is intended to extract the lead and silver as perfectly as possible, and to concentrate the copper into a matt.

The lead matt is twice roasted, together with the first dross from the cupelling process, which contains 40 to 50 per cent of lead, 6 to 8 per cent of copper, and 9 or 10 per cent of antimony and arsenic. The roasting is performed in heaps, the first operation lasts from 8 to 14 days, and the second 8 days.

**First Lead Matt Smelting.**—The roasting mass is mixed with unroasted furnace ends from all the different smelting processes, and sometimes even with roasted argentiferous copper ores. No addition of iron is made, in order to reduce the amount of silver in the matt, and to produce less basic slags. The following mixtures are used:—At Müsen  $9\frac{1}{2}$  cwts. of lead matt,  $\frac{1}{2}$  a cwt. of dross, from 2 to 3 cwts. of metallic soot, from 2 to 3 cwts. of copper ore, and  $7\frac{1}{2}$  cwts. of lead ore slags; at Rothenbach, 9 cwts. of lead matt, 1 cwt. of dross,  $3\frac{1}{2}$  cwts. of metallic soot, and  $7\frac{1}{2}$  cwts. of lead ore slags; and at Lohe, 8 cwts. of lead matt, 2 cwts. of dross, 2 cwts. of metallic soot,  $4\frac{1}{2}$  cwts. of copper ore, and  $10\frac{1}{2}$  cwts. of lead ore slags. The smelting process is performed in low cupola furnaces, and gives a better result when commenced in a furnace that has been just used for reducing litharge, &c., and is still hot. From 12 to 15 barrows of mixture of 30 lbs. each are charged upon 25 lbs. of coke, or 12 to 14 lbs. of mixture to 1 lb. of coke. In a furnace with one tuyere 2 tons of mixture without slags are smelted daily, and in a furnace with 2 tuyeres from  $2\frac{1}{2}$  to 3 tons, consuming from  $4\frac{1}{4}$  to 6 cwts. of coke. The produce are: **Raw Lead** with 4 or 5 ozs. of silver, containing more antimony and copper than that resulting from the ore smelting; **Lead Matt** with 20 per cent of lead, 15 to 20 per cent of copper, and  $2\frac{1}{2}$  to 3 ounces of silver; **Metallic Soot and Slags**, containing 1 to  $1\frac{1}{2}$  per cent of lead. The second lead matt, like the first, is twice roasted. The roasted matt is then smelted, either by itself or with roasted argentiferous copper ore, and if

necessary with an addition of clay slate. Such a mixture contains:—

10	cwts.	second lead matt.
3 to 5	„	copper ores.
0·2	„	clay slate.
9	„	lead ore slags.

The smelting is also conducted in low cupola furnaces still hot from the previous operation. From 2 to 2½ tons of the mixture without slags are smelted in 24 hours, consuming 6 or 7 cwts. of coke, and yielding—

Raw lead with 5 or 6 ounces of silver, lead matt containing from 10 to 15 per cent or more of lead, from 30 to 50 per cent of copper, and from 2½ to 3 ounces of silver per cwt.; the slags are used as flux in the ore smelting process.

The third matt is worked up again in the following way. If it contains more than 12 per cent of lead it is roasted like the first and second lead matt, and smelted in the following mixture—

10	cwts.	third lead matt.
4 to 6	„	copper ores.
10·5	„	lead ore slags.

The resulting raw lead contains from 5 to 6 ounces of silver, containing more copper, but less antimony than the former sorts. The copper matt containing from 45 to 50 per cent of copper, from 5 to 10 per cent of lead, and from 2½ to 3½ ounces of silver, is submitted to three successive smelting operations, mixed up with such quantities of litharge or hearth that ½ ounce of silver corresponds respectively to 8, 12, and 15 lbs. of lead, and so that the extraction of silver takes place in the proportion of 4 : 2 : 1; by which operation the copper matt containing originally 3 ounces of silver will at last contain only about ½ an ounce. Litharge is only employed when hearth ends are not to be had. The latter require an addition of clay slate.

The following mixtures are used in the first process for extracting silver from the copper matt:—10 cwts. of copper matt, 8½ cwts. of hearth, from 0·25 to 0·50 cwts. of clay slate, and 12 cwts. of lead slags; or 10 cwts. of copper matt, 6½ cwts. of litharge, and 10½ cwts. of slag.



In 24 hours, 40 cwts. of copper matt and 50 cwts. of copper ore slags are worked in low cupola furnaces with one and two tuyeres, consuming about 6 cwts. of coke, giving raw lead with 3 to  $3\frac{1}{2}$  ozs. of silver, and copper matt containing about  $1\frac{1}{2}$  ozs. of silver.

The following is the mixture for the second process:— 10 cwts. of matt, from 1 to 2 cwts. of copper ores, 5·1 cwts. of hearth, 0·8 cwts. of clay slate, and 12 cwts. of lead slags; or 10 cwts. of matt, from 1 to 2 cwts. of copper ores, 4 cwts. of litharge, and  $10\frac{1}{2}$  cwts. of lead slags.

This process, like the former, gives raw lead with about  $2\frac{1}{2}$  ozs. of silver, and copper matt with about 1 ounce of silver per cwt.

For the third smelting process the mixture is 10 cwts. of copper matt, 6·6 cwts. of hearth, from 2 to 3 cwts. of copper ores poor in silver, 12 cwts. of lead slags, and from 0·2 to 0·3 cwts. of iron refinery cinders. The resulting copper matt, containing about  $\frac{1}{2}$  oz. of silver, is smelted at the copper works.

In 1860 were produced at Lohe, 2,117 lbs. of silver, 71 tons of lead, 506 tons of litharge, and 28 tons of copper; at Müsen, 836 lbs. of silver, 15 tons of lead, 142 tons of litharge, and 20 tons of copper; and at Rothenbach, 1,940 lbs. of silver, 35 tons of lead, 69 tons of litharge, and 26 tons of copper.

The roasting reduction process is also used in different French smelting works, as shown in the following examples:

At Pontgibaud.\* Here the lead ores are worked in the form of schlich, and associated with blende, iron pyrites, quartz, baryta, and felspar. The treatment of these ores is difficult on account of their containing so little lead in comparison with their silver.† They contain on an average from 25 to 36 per cent of lead, and from 12 to 17 ozs. of silver in 2 cwts. of raw lead.

\* ERDMANN, Jour., f. ök. u. techn. Chem., xiii., 208. Ann. d. min. 4 sér., 5 livr. de 1851. B. u. h. Ztg., 1851, No. 17.

† COTTA, Erzlagertätten, ii.; 418. B. u. h. Ztg. 1858. p. 32.

The ores are roasted in reverberatory furnaces with two hearths, one above the other. In Figs. 56, 57, and 58

www.libtool.com.cn FIG. 56.

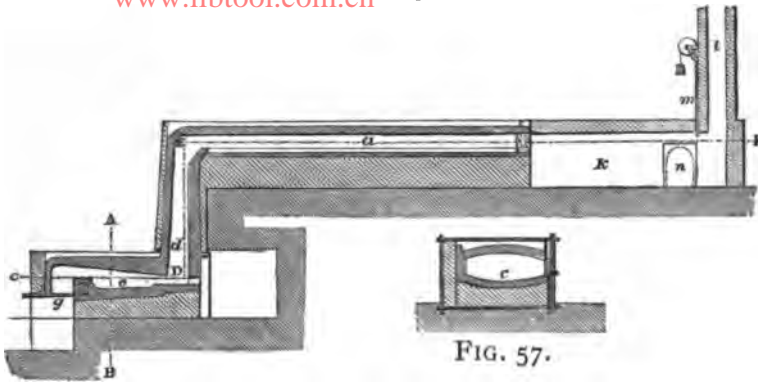
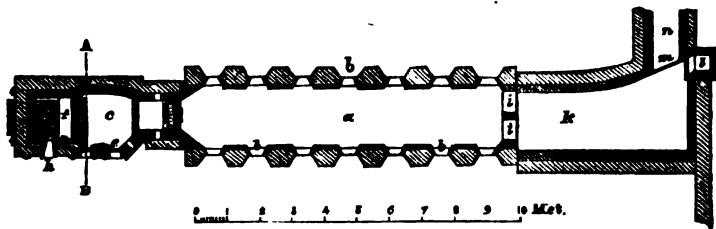

FIG. 58.



*a*, is the upper hearth ; *b*, the working doors ; *c*, the hearth for caking the ores after they have been roasted in the upper hearth ; *d*, the channel for conveying the roasting mass from the upper hearth to the lower one, and for passing the flame to the upper hearth ; the hearth, *c*, consists of fire-bricks coated with a layer of lime and sand, 0·10 metre thick ; *e*, the working doors ; *f*, fire-bridge ; *g*, grate ; *h*, door for charging coal ; *i*, flues ; *k*, condensation chamber, from which the gases and metallic fume either enter the chimney, *l*, or pass by means of a channel, *n*, into another chimney ; this last channel is intended to condense the fume.

This furnace consumes little fuel, and effects a most perfect roasting.

In 24 hours, 7·2 tons of ore are roasted, causing a loss of

from 11 to 12 per cent ; 6.3 to 6.5 tons of ore in form of cakes, require from 1.9 to 2.0 tons of coal, amounting to from 30 to 31 per cent of the roasted ore.

A roasting mass, which was vitreous, of porphyry-like texture, and free from visible galena, containing according to the dry assay, 35 per cent of lead, and about 2 ounces of silver per cwt. was shown by analysis to be composed as follows :—

1.5 per cent of oxide of lead, 0.6 per cent of oxide of tin, 0.7 per cent of protoxide of iron, 7.4 per cent of sulphate of baryta, 6.7 per cent of sulphate of lead, 1.4 per cent of sulphide of lead, 24.1 per cent of silica, 34.1 per cent of oxide of lead, combined with silica, 3.3 per cent of oxide of tin, combined with silica, 16.3 per cent of peroxide of iron, combined with silica, 1.3 per cent of magnesia, soda, and potash, and 1.0 per cent of lime and of baryta, the latter also combined with silica ; besides traces of antimony and arsenic.

The smelting furnaces are 1.6 metre high above the tuyere, 0.45 metre deep beneath the tuyere, 0.9 metre, and 0.6 metre wide. One mixture consists of—

20 cwts. of roasted ore, 2 cwts. of fluor spar,  $4\frac{1}{2}$  cwts. of limestone, 2 cwts. of iron,  $\frac{1}{2}$  cwt. of hearth, scum, and residues, and 10 cwts. of old rich slags ; altogether 39 cwts.

This is worked in 8 hours, consuming 3 cwts. of coke, and producing 25 parts of raw lead from 100 parts of ore ; the operation lasts from 40 to 50 days.

The resulting products are—

1. **Raw Lead**, with 96 per cent of lead, and upwards of  $8\frac{1}{2}$  ounces of silver per cwt. The silver is extracted by the cupelling process, the resulting silver re-melted in crucibles, the red litharge rolled in order to separate the grains of lead mixed up with it ; the more compact litharge is ground and washed, and the impure litharge is ground, washed, and reduced to lead ; the scum and hearth are added to the mixture of the ore smelting.

2. **Lead Matt** is only produced when the roasting process is badly conducted ; it contains 63 to 76 per cent of lead, and about 3 ozs. of silver per cwt.

3. **Slags**, usually containing 1 to 3 per cent of lead.
4. **Metallic Fume**, containing 56 to 62 per cent of lead, and 1 to  $1\frac{1}{2}$  ozs. of silver per cwt. In 24 hours three furnaces smelt from 9 to 10 tons of roasted ore, producing from 2·5 to 3·0 tons of raw lead.

At Vialas.\* Here the lead ores are associated with quartz and clay slate, also with blende, iron pyrites, lime, sparry iron ore, and baryta, but in smaller quantities; they contain when dressed, 42 per cent of lead and  $7\frac{1}{2}$  ozs. of silver per cwt.

The crushed ores are roasted in reverberatory furnaces with one hearth, in lots of 1 ton, mixed with 160 lbs. of fume and of intermediate plumbiferous products of the operations of the year before; the temperature of the furnace must be so regulated that the mass does not completely fuse. As soon as part of the charge is sufficiently caked, it is removed from the furnace, and the remainder is moved nearer the fire-bridge, in order to obtain the high temperature required for caking; when the masses cake again, they must be taken out, until all the contents are removed from the furnace. The caking occupies about 6 hours, and the whole roasting process about 16 hours; 3 tons of ore require about 1 ton of coal for roasting; the loss amounts to about 20 per cent, and the cost per ton of ore is about 12s. 8d.

For the purpose of smelting, 1,000 parts of roasted ore are mixed with 40 parts of heavy spar, 35 parts of sparry iron ore, 170 parts of dross and hearth, and 400 parts of ore slags.

The reduction of the ore is effected in low cupola furnaces chiefly by the reaction of the fuel; heavy spar acts as a flux and reducing agent; the iron ore chiefly as a flux.

The normal smelting process is carried on with coke, and requires a nose from 0·15 to 0·20 m. long, and no flame at the mouth of the furnace. The operations last from 8 to 13 days. In an operation of 10 days and 12 hours, from 90·19 tons of mixture containing 34·33 tons of lead and 244 lbs. of silver, there were produced 25·50 tons of raw lead with 234 lbs. of

\* LAN., in Ann. d. m., 1854, liv. 6; 1855, liv. 2., p. 390.

silver; and the consumption of fuel amounted to 14'90 tons of coke. The cost of smelting 1 ton of ore amounts to 17s., and 1 ton of ore yields 0'438 ton of raw lead with 3'794 lbs. of silver. Only very little matt is formed. The pure slags contain as much as 2 per cent of lead.

The cost of roasting and smelting 1 ton of ore is—

	£	s.	d.
Labour . . . . .	0	7	0
Fuel (0'595 ton) . . . . .	0	15	0
Fluxes (0'070 ton) . . . . .	0	1	0
Sundries . . . . .	0	3	3
	£1 6 3		

The total loss of metal per ton of ore amounts to 0'059 ton of lead and 0'0596 lb. of silver.

In 1855-56, 665 tons of schlich, containing on an average 50 per cent of lead and 0'230 per cent of silver, were roasted, with a consumption of 389 tons of coal; 640 tons of the roasted mass, and 214 tons of dross, hearth, &c., yielded 336 tons of raw lead, consuming 334 tons of coke. The raw lead yielded on cupellation 3'1 cwts. of silver, 71 tons of red litharge, 169 tons of yellow litharge, 9 tons of impure litharge, and 30 tons of dross.

The lead ores from Southern France, Algeria, Corsica, Spain, Italy, &c., which are sold at Marseilles, are worked at the smelting works on the mouths of the Rhone; they contain at least 40 or 50 per cent of lead, if they are not rich in silver. Galena rich in lead, and containing but little silica, is worked in reverberatory furnaces according to the French method; but ores richer in silica are treated either in the Vienne furnaces, or are smelted in cupola furnaces after having been previously roasted.

The roasting of the ore is effected in single reverberatory furnaces with two hearths, as at Escalette and St. Louis; and in mounds.

At the Catalan Works the smelting process is carried on in cupola furnaces of a medium height, and the charges at the last-named works are 4 shovels of ore, 4 of coke, 2 of lead

slags, and half a shovel-full of refinery cinders; but the amount of this last addition varies at the different smelting works (Septèmes, St. Louis) according to the nature of the ores. In 24 hours 3 tons of ore are worked, consuming 1 ton of coke.

At the smelting works at Bottino, in Tuscany,\* pure galena,† with from 55 to 64 per cent of lead, is treated in reverberatory furnaces; but all ores containing silica, and from 42 to 45 per cent of lead, are worked in cupola furnaces after a previous roasting; the roasting is conducted in double reverberatory furnaces, and entails a loss of 6·30 per cent.

The smelting process is carried on in cupola furnaces 3 metres high, 1 metre deep, and 0·5 metre wide; and 4 charges are added every hour, consisting of 5 barrows of 30 to 40 lbs. each of ore, and 5 to 6 barrows of 24 to 30 lbs. each of iron refinery cinders and poor lead slags; 132 tons of ore with 42 per cent of lead, 3 tons 13 cwts. of slags from the litharge reducing process with 15 per cent of lead, 2 tons 15 cwts. of slags from the reverberatory furnace with 20 per cent of lead, 129 tons of hearth with 50 per cent of lead, and 81½ tons of refinery cinders, yielding in 24 hours 58½ tons of raw lead, and from 1½ to 2 tons of matt, which were replaced for the smelting process; the consumption of fuel amounted to 83 tons of charcoal, and 8 tons of coke.

In different localities of Spain,‡ lead ores are worked after they have been roasted (Carmelita), but smelting processes without previous roasting are used, as well as the reverberatory process.

These cupola furnaces are constructed like sump furnaces, and are 1·50 metre high; the roasting takes place in reverberatory furnaces. The mixture for the smelting process is composed of 5 tons of roasted galena containing on an average 18 per cent of lead, 6 cwts. of raw galena, 4 cwts. of litharge containing from 80 to 85 per cent of lead, 10 cwts. of lead hearth, &c. with 60 per cent of lead, and 70 cwts. of slags. The ores yield from 9 to 10 per cent, and the total

\* B. u. h. Ztg., 1856, p. 1. Ann. d. min., 1858, livr. 6, p. 579.

† CORRA, Erzlagerstätten, ii., 374. B. u. h. Ztg., 1861, p. 406.

‡ B. u. h. Ztg., 1862, p. 56.

mixture 15 or 16 per cent; the cost of working 2 cwts. of ore is 2s. 1d.; calculated for 1 cwt. of lead it amounts to 14s. 5d.; 15 or 16 per cent of coke will smelt 100 parts of mixture, and 1'50 to 1'65 parts of coke reduce 1 part of metal.

**Illustrations of the Processes for Working Rich Lead Ores, containing Earthy Matter, but Little Foreign Sulphides.**

At Bleiberg, near Commern,\* the ores occur in the lower schists of the red sandstone formation, partly in grains more or less fine, and partly disseminated in extensive beds of sandstone; white lead ore is now and then found on the head of the formation, instead of galena. The whole ore mass contains from 0'2 to 5 per cent, but on an average 2 per cent of galena, and yields  $1\frac{3}{4}$  per cent of lead, containing from 0'007 to 0'014 per cent of silver. A similar ore occurring on the Maubach Bleiberg, near Düren, contains on an average 5 per cent of lead.

At the mining property of Meinertzhagen from 17,000 to 18,000 tons of dressed lead ores, containing from 55 to 58 per cent of lead, are annually obtained, and are mostly worked at the smelting works in Stolberg, near Aix-la-Chapelle; whilst only a small part is worked at the Burgfeyer Smelting Works for the manufacture of shot, the annual production of which amounts from 125 to 150 tons. About 1,750 to 2,000 tons of ores are used for glazing pottery, and sold at 11s. or 11s. 6d. per cwt.

The schlich for smelting is mixed with 3 per cent of lime and moulded into bricks, which are allowed to dry in the air, and become very hard in consequence of a formation of silicate of lime. They are then crushed into pieces the size of the fist, and are smelted in small cupola furnaces  $4\frac{1}{2}$  feet high, 20 inches deep, and 14 inches wide, but higher furnaces have lately been introduced.

At the Mühlgasse Smelting Works\* the ores raised from the mine at Peterhaide are roasted in three reverberatory furnaces

\* KARSTEN'S Archiv., ix., 60. TUNNER'S Jahrbuch, ii., Jahrgang, 1852, p. 56.

\* Preussische Zeitschrift, 1859, p. 226.

with hearths 22 feet long and 12 feet broad; the arched roof is 2 feet above the middle of the hearth, and the furnaces have 8 working doors on each side.

After the schlich has been dried for 2 or 3 days on an iron plate hearth, it receives an addition of lime, about 3 or 5 per cent, seldom as much as 10 per cent. About  $2\frac{1}{2}$  tons of such mixed schlich are then charged upon the back part of the hearth, spread out and gradually moved by means of iron rakes towards the fire-bridge, where the temperature is so high that the mass fuses. Every 6 hours from 40 to 50 cwts. of the mass are removed from the furnace, whilst what remains in the furnace is moved towards the discharging opening to make room for a new charge which remains in the furnace for 36 hours; each furnace holds 6 charges.

The mass must not become liquid enough to produce metallic lead, as this would increase the loss of metal and allow the mass to run easily out of the furnace. The space for scorification inclines four inches towards the discharging orifice which is closed by a door. As soon as the mass has acquired the proper consistence, and no more blisters form, and the scorification is uniform, it is drawn into the sump and allowed to flow into iron moulds running upon wheels. From 8 to 10 tons of ore are roasted in 24 hours, with a consumption of about 56 cubic feet of coal; two workmen attend to the furnace in shifts of 12 hours; the smoke is conducted by a flue 360 feet long, 12 feet broad, and 22 feet high, into a chimney 132 feet high and 4 feet wide. The loss in the roasting process amounts to 7 per cent, not including the metal contained in the condensation flues. This scorification during the roasting process is facilitated by the presence of white lead ore, and therefore requires less fuel and labour than the common roasting. This saving is of great importance, as the ores contain but little silver.

The scorified mass is smelted in cupola furnaces 16 feet high, 4 feet wide, and 4 feet deep, constructed like crucible furnaces. The escaping gases and smoke are conducted into a condensation chamber lying 20 feet above the hearth of the furnace.



As the materials are measured instead of weighed, the data of the smelting results are not quite exact. According to the "Preuss. Ztschr." (vii. 226), 5 tons of lead ores, previously roasted with an addition of 10 per cent of lime, are smelted in admixture with 25 cwts. of calcareous oolitic red iron ore,  $4\frac{1}{2}$  tons of old lead slags, and 3 cwts. of iron. 10 tons of ore yield about 5 tons of lead in 24 hours. The red iron ore gives better results than the refinery cinders formerly used; the addition of metallic iron is intended to lessen the production of matt.

The raw lead with the 0.2 oz. of silver per cwt. is treated by Pattinson's process, which concentrates the amount of silver to 12 or 13 ozs. The lead matt contains as much as 23 per cent of lead. The slags are so poor that they may be thrown away. The metallic fume is added to the mixture of the next operation, and is previously heated till it cakes. The smoke of 2 furnaces produces in 6 weeks about 25 or 30 cwts. of lead. The reduction of the red iron ore causes deposits in the hearth. In the year 1860,  $625\frac{1}{2}$  lbs. of silver and 1,883 tons of lead were produced.

At Münsterbusch, near Stolberg (Aix-la-Chapelle), the lead ore (Dieplinchen) is associated with calamine, zinc blende, a little iron pyrites, calc spar, and quartz; some galena from Commern, containing 50 per cent of lead and 30 per cent of quartz, is worked; white lead ore is also used in small quantity. The ores are delivered to the smelting works in the form of grains and schlich, and the ores from Stolberg yield when worked alone, a raw lead containing about 1 oz. of silver, whilst from the ores of the Eifel a raw lead is produced containing about  $\frac{1}{2}$  oz. in 100 lbs.; the ores contain no copper. The mixture used contains 55 per cent of lead and 0.375 oz. of silver per cwt.

The ores from Dieplinchen are roasted as at Binsfeldhammerhütte (page 63), and those from Commern as described at page 157. From 8 to 10 tons of ore are roasted in 24 hours, consuming 39 cubic feet of small coal and 4 cwts. of coal in lumps, costing about 19s. 6d. The roasting mass contains from 60 to 70 per cent of oxide of lead, and has a vitreous fracture, a greasy lustre, and a completely homo-

geneous appearance. According to Eich, it consists of 18·18 per cent of silica, 3·87 per cent of alumina, 2·56 per cent of peroxide of iron, 71·80 per cent of oxide of lead, 1·12 per cent of lime, 0·37 per cent of magnesia, and 0·49 per cent of sulphur. 5 tons of ore are mixed with 4 tons of iron refinery cinders, and 4 to 5 cwts. of limestone, and are smelted with 24 or 25 cwts. of coke in crucible furnaces with 2 tuyeres; the operation in 1 furnace lasts 2 or 3 weeks; 8 furnaces consume about 55 tons of ore and 15 tons of coke in 24 hours, producing on an average 30 tons of lead; 400 tons of ore yielded 200 tons of lead. The lead is tapped off every 4 hours.

When the process goes on well, the production of lead matt only amounts to about 1 per cent, which is roasted and added to the mixture; if it contains from 3 to 4 per cent of copper it is kept for the purpose of extracting the copper from it. These works, like all the smelting works near Stolberg, have extensive flues for condensing the smoke, which is much poorer in silver than ore with the same amount of lead; the production of smoke is about 1 or 2 per cent; the slags are assayed daily, and if they contain more than  $\frac{1}{2}$  per cent of lead they are returned and resmelted. The slag is run into cast iron pots, 14 inches wide and 20 inches deep, which are suspended in two-wheeled barrows; when the slag is sufficiently liquid, the lead and matt, which may be mechanically mixed up with it, will deposit in the pots.

According to F. Osann, these slags are composed as follows: 33·57 per cent of silica, 6·64 per cent of alumina, 54·93 per cent of protoxide of iron, 3·41 per cent of lime, 0·28 per cent of magnesia, 2·04 per cent of oxide of lead, 0·11 per cent of oxide of zinc, and 1·53 per cent of sulphur.

In 1860, the smelting works at Münsterbusch produced 2,683 lbs. of silver and 6,955 tons of lead.

A similar process is carried on at the smelting works in Ramsbeck (Westphalia), which produced in 1860, 2,755 lbs. of silver, 1,957 tons of lead, and 144 $\frac{1}{2}$  tons of litharge.

At the smelting works at Ems,\* argentiferous galena is

\* COTTA, Erzlagerstätten, ii., 142. ERDMANN'S Journ. f. ök. u. techn. Chem. xiii., 204.

used in the form of schlich, grains, and fragments, associated with blende, sparry iron ore, and a little quartz; the metal contained in the ore varies between 40 per cent of lead and 0.35 oz. of silver per cwt., and 65 to 70 per cent of lead and 1.4 oz. of silver; most of the ores contain on an average about 50 per cent of lead, and 0.9 oz. of silver per cwt.

The ores are converted into the form of schlich, in order to admit of a better roasting, and the process is carried on in double furnaces, with one hearth lying at the side of the other, and capable of receiving 3 tons in six lots. One lot is brought to the caking state on the fire-bridge, and removed every 4 hours, and a new charge is added on the back of the hearth; from 3 to 3½ tons of ores are roasted in 24 hours, consuming 11.5 cwts. of coal, and each furnace is attended to by two workmen, working in shifts of 12 hours; 6 per cent of lead is lost in the roasting.

The roasting mass is mixed with 25 per cent of slags from the puddling and re-heating furnaces, from 75 to 100 per cent of lead ore slags, from 8 to 10 per cent of limestone, and as much metallic iron. More or less sparry iron ore, containing from 5 to 15 per cent of lead, may be substituted for the metallic iron or the ferruginous slags, if desired.

The smelting is effected in furnaces with two tuyeres according to Vogl's construction.

The raw lead from the ore and matt smelting processes is cupelled in quantities of 17½ tons, containing about 1.7 oz. of silver per cwt.; 5 tons of raw lead produced in 1861—

Scum	. 6.59	per cent,	containing	5.89	per cent	of lead.
Hearth	. 13.41	„	„	8.72	„	„
Litharge	88.36	„	„	81.99	„	„
Loss	. . . .			3.40	„	„

The resulting silver is refined in a small furnace holding 30 lbs.

The lead matt is roasted in Hungarian reverberatory furnaces, in order to conduct the gases into a common chimney by means of a flue 500 feet long; the second lead matt, with about 12 per cent of lead, is roasted and re-smelted; its amount of lead is thus reduced to 3 per cent, when it may be thrown aside, for though it contains from 1 to 2 per cent of copper this cannot be profitably extracted.

## DIVISION II.

**TREATMENT OF OXIDISED ORES AND PRODUCTS.****Oxidised Ores.**

**Carbonate of Lead** (white lead ore) is usually treated by metallurgical processes differing from those employed for the sulphate. Oxidised ores generally occur together with galena, and are worked with them, either by the common lead process (Ruszberg, Holzappel), or by a modified process (scorification roasting at Commern and Stolberg). In rare cases only is white lead ore worked by itself, either in reverberatory furnaces or in cupola furnaces, according to the richness of the ore, the earthy and metallic gangue, or the price of materials.

**REDUCTION OF WHITE LEAD ORE IN REVERBERATORY FURNACES.**

Rich ores only are treated in these furnaces, and when the price of coal is not too high; furnaces with a sump or an inclined hearth are used, and a reducing reaction is to be performed; the grate of the furnaces is low down, and the working door is put under the flue to prevent the access of air to the hearth.

The crushed ore is mixed with 7 or 8 per cent of charcoal or coke rubbish, or with 13 or 14 per cent of non-caking coal or brown coal; when charcoal or coke rubbish is used, a finer division of the ore is requisite, as they chiefly act by direct contact with the roasting mass, necessitating a more intimate mixture. Raw fuel develops reducing gases abundantly; these gases permeate the particles of ore, and therefore raw fuel allows the treatment of ores of coarser grain; the reduction takes place quicker and at a lower temperature, and less loss occurs from the escape of ore dust owing to the coarser state of the ore. The coal should be in such large pieces as to evolve gases during the whole period of reduction. Anthracite reacts less upon oxide of lead, and requires a higher temperature.

The ore is then spread out upon the hearth of the furnace,

M

and treated by a reducing flame at a gradually increasing temperature; it is repeatedly turned as long as any lead is extracted; the porous residues are then moved towards the fire-bridge and heated till they cake; this is done in order to avoid a reduction and volatilisation of lead in the upper parts of the cupola furnace in which they are worked up again. Very little lead is extracted during this period. Lime will prevent the caking if no silica is present, and in this case easily fusible slags must be added to replace the silica. Sulphates of baryta and lime are reduced, partly by the caking process and partly by the smelting of the residues in cupola furnaces; the metallic sulphides formed react advantageously in the reduction of oxide of lead, and the oxides of calcium and barium facilitate the formation of slags. Sparry iron ore reacts in the first process like lime, but facilitates the formation of slags; calamine occasions a loss of metal by volatilisation, counteracts the caking, and causes in the smelting process in cupola furnaces the formation of soot and difficultly fusible slags; it also renders the raw lead impure.

The products of the smelting process are—

1. **Lead**, with more or less silver;
2. **Smoke**, consisting mostly of fine ore dust;
3. **Residues**. These are mixed with other lead products (impure litharge, scum, metallic fume, &c.), and ferruginous substances, and smelted in low cupola furnaces.

#### **TREATMENT OF WHITE LEAD ORE IN CUPOLA FURNACES.**

Ore in the form of grains and coarse sand is best worked in cupola furnaces; the schlich is previously mixed with lime and moulded into shape, and the ores are usually mixed with lead products, impure slags, and ferruginous substances. The porosity of the ore and its easy reducibility cause the formation of metallic lead in the upper part of the furnace, and to avoid as far as possible this disadvantage, the smelting process is carried on in low sump or crucible furnaces, in which a suitable pressure of blast produces a high temperature round the tuyere. The mixture then passes quickly before the tuyere, smelts rapidly, and the reduced lead is not

exposed so long to the action of the escaping gases as in higher furnaces. When the ore fragments are more compact, higher furnaces may be used to save fuel; the ore is then mixed with fuel to assist the reduction of the oxide of lead. The loss of lead by volatilisation caused by this smelting process is always very large, and when the ore is used in large fragments, it amounts to from 45 to 50 per cent of the lead contained in the mixture, and to 20 per cent of the silver; therefore extensive condensation chambers are necessary. The smoke produced may be either worked up with the ore or with the lead products.

Of the associating gangues, quartz, limestone, and ferruginous substances have a favourable influence; also baryta when present in small quantity, but a larger quantity of it assists the formation of matt, and requires a considerable addition of siliceous substances for the formation of silicate of barium, thus causing an increased consumption of fuel, a decrease of the amount of metal contained in the mixture, and a greater loss of metal by volatilisation. Baryta is therefore only used, when necessary as a flux, for the scoriification of quartz (Altai Smelting Works); calamine acts disadvantageously; galena behaves as in the reverberatory process.

#### **Illustrations of the Cupola Furnace Process for Reducing White Lead Ores.**

At the five Altai smelting works\* in Barnaul, Pawlowskiy, Zmjejewskiy, Loktewskiy, and Gawbrilowskiy, about 57,000 tons of ore† are worked yearly; one half consisting of baryta with about 0·0065 per cent of silver without lead; and the other half of silver and lead ores containing on an average 0·02 per cent of silver and from 8 to 20 per cent of lead. The metals are mostly contained in the ores in an oxidised state, as white lead ore, lead ochre, iron ochre, malachite, azurite, and calamine, besides some zinc blende and galena. The earthy gangues are chiefly quartz, baryta, slate, &c. Part of the silver ore is worked together with the

\* B. u. h. Ztg., 1853, p. 138, 180. Bergwerksfreund, 1853, Bd. xv., p. 321.

† Cotta, Erzlagertätten, ii. 567.

argentiferous baryta for the production of raw matt, the silver being extracted by metallic lead (*vide* Silver), and the rest is worked with the lead ores and baryta. The treatment of these ores is very difficult as they are poor and difficult to fuse, and on account of the easy reduction of the white lead ore; they are very siliceous, poor in iron and other bases, therefore the baryta, together with much limestone and sea-salt, is required for the scorification of the quartz.

A smelting mixture consists of about  $2\frac{1}{2}$  tons of lead and silver ores, 13 cwts. of matt of the raw smelting or the lead ore smelting, 3 cwts. of baryta, 4 cwts. of sea-salt, 8 cwts. of limestone, and 14 cwts. of slags of the raw smelting, and lead products (scum, hearth ends, &c.).

The smelting is carried on in sump furnaces 12 feet high, working about 31 cwts. in 24 hours, and consuming 160 lbs. of coal for 100 lbs. of ore.

The products are—

*a.* **Raw Lead** containing about 0·126 lb. of silver and 93 to 95 per cent of lead, besides copper, iron, antimony, and sulphur. By cupelling this lead, silver is produced, containing from 3 to  $3\frac{1}{2}$  per cent of gold, and litharge which is used to extract the silver contained in the raw matt; scum and hearth ends are added to the lead smelting.

*b.* **Lead Matt** containing about 0·025 lb. of silver, and as much as 12 per cent of lead and 20 per cent of copper; it is worked again in the lead smelting process, and is afterwards used in copper smelting.

*c.* **Slags** containing 0·005 lb. of silver; these are bi- and tri-silicates, and are seldom completely fusible; some are used as a flux in the raw smelting, and some are smelted at the beginning of a raw smelting operation, with from 5 to 10 per cent of limestone, and from 10 to 20 per cent of heavy spar poor in silver, in sump furnaces 16 feet high, for the production of raw matt which is added to the lead smelting process.

At the smelting works in Münsterbusch, white lead ore is worked like galena (page 158), having been first mixed with pounded refinery cinders and burned lime, in the proportion

of 8 : 1 : 1, moistened with water, formed into irregular pieces, and dried.

In Southern Spain, mixtures of white lead ore, sulphate of lead, and more or less galena, are worked in various smelting works in low cupola furnaces of different dimensions, constructed partly as sump furnaces, and partly as crucible furnaces; the following are the chief constructions :—

1. *Castilian furnaces*, from 0·85 to 1·3 metres high, 0·84 to 0·9 metre deep, and 0·7 to 0·74 metre wide; they are either sump or crucible furnaces. About 5 tons of ferruginous white lead ore and galena with 25 per cent of lead, and 25 to 50 cwts. of old slags with  $1\frac{1}{2}$  or 2 per cent of lead, are worked in 24 hours, consuming 20 cwts. of coke and producing  $21\frac{1}{2}$  cwts. of raw lead with 4·4 ozs. of silver per cwt. of lead; the yield of lead therefore amounts to 20·43 per cent. The cost for smelting 1 cwt. of ore is 10d., for 1 cwt. of lead, 8s. 7d.; one part of coke is used to one part of metal, or five parts of ore.

2. *Round crucible furnaces at Escombreras*, with two tuyeres, 1·68 metres high, 1·5 metres in diameter at the upper part of the furnace, and 1·3 metres diameter at the lower part. The lead collects in a sump which is situated at the side of the furnace, and the slags flow out through a rectangular opening. The mixture, containing from 35 to 40 per cent of lead, consists of  $7\frac{1}{2}$  tons of galena and white lead ore and  $3\frac{1}{4}$  tons of the slags of a former process; and in 24 hours from 48 to 54 cwts. of lead with 1·7 ozs. of silver per cwt., are produced, consuming from 32 to 34 cwts. of coke. The yield of lead therefore amounts to 34 per cent; 5 per cent of lead matt also results, and is worked up in a subsequent operation. To smelt 1 cwt. of ore costs 11d., and 1 cwt. of metal, 5s. 4d.

3. *Round crucible furnaces of Roma*, with three tuyeres, from 1·65 to 1·7 metres high, 0·5 metre in diameter at the top, and 1·3 metres in diameter at the bottom; the three tuyeres, two of them fixed in the side walls, and one in the back wall, converge towards the middle of the furnace, and incline towards the bottom at an angle of 8° or 10°.

The ore used consists of galena mixed with arsenical com-



pounds, and containing carbonates and sulphates.  $8\frac{1}{2}$  tons of ore, mixed with  $3\frac{1}{2}$  tons of residues of the reverberatory furnace and old slags, are smelted in 24 hours, consuming 35 cwts. of coke, and producing from 17 to 21 cwts. of raw lead containing about 1·2 ozs. of silver per cwt. The yield is about  $12\frac{1}{2}$  per cent. To save fuel, the furnaces are worked with a hot blast. The cost for smelting 1 cwt. of ore is 9s. 4d., and for 1 cwt. of lead, 10s. 11d. The consumption of fuel is 21 per cent for the ore, and 1·65 parts for 1 part of metal.

4. *Castilian furnaces of Pormann.*—Some of these have three tuyeres, others only one or two. Carbonate of lead and old Roman slags are chiefly worked in them. They are mostly square or rectangular in section; those with three tuyeres are from 1·25 to 1·3 metres high.

5. *Air cupola furnaces* (Hornos de Gran Tiro, Pavos) are used at Carthage for working white lead ore occurring with clay, quartz, oxides of antimony and zinc, blende, and arsenical iron pyrites; this ore is very difficult to fuse, and contains from 11 to 12 per cent of lead.

The shaft of the furnace is constructed in the form of a cask, and is connected with a horizontal flue leading into the chimney. The air for combustion is conducted into the furnace by six nozzles of clay. From this point up to the mouth the shaft is 1·7 metres high, the diameter in the middle is 1·29 metres, and in the upper and lower parts respectively 1·21 and 1·16 metres.

To commence, the furnace is filled with brush-wood and a little coke; this is lighted at the nozzles, and after five or six hours the furnace will be dried, and will have attained a moderate temperature. Coke is then added, together with some lead for filling the sump and keeping it free from scoria, and after some hours, when the furnace has attained a red heat, light charges of ore and lead slags are added together with coke; the half closed nozzles are opened, the fuel is gradually diminished, and the charge of ore increased. A somewhat tough slag will then begin to flow out of the furnace; the attention of the workman must now be directed to keep the nozzles always clean; the highest charge must

then be obtained as soon as possible, and it must be modified according to the process. When the operation is normal, the nozzles are clear allowing the smelting of the lead and slags to be observed; if they become dark, this will indicate that the process is probably deranged by the presence of too large pieces of ore, and the mass becomes easily chilled. If the slags are too liquid, the quantity of lead flux is increased.

The charging must be conducted accurately; large charges usually should be added hourly, in order to avoid as far as possible any injury to the draught. In order to conduct the gases, and consequently the heat, to the middle of the furnace, the ore is mostly charged on the walls, and according to the brightness of the nozzles in smaller or larger quantities at any one point. These furnaces sometimes make operations of two months or longer, the nozzles having to be frequently renewed.

The mixture for 24 hours consists of 10 tons of ore and  $2\frac{1}{2}$  or 3 tons of slags, and one charge of about 7 cwts. of ore, 10 or 12 baskets of slags with  $\frac{1}{2}$  old slags, and 6 to 7 baskets of coke with a little wood, which is added in order to render the smelting mass less compact, as this would injure the draught; the slags assist the smelting, and by passing down the furnace in a softened state they absorb metallic particles and prevent the volatilisation of metal. From  $32\frac{1}{2}$  to 35 cwts. of coke are consumed in 24 hours, producing about 16 cwts. or 9 per cent of lead at a loss of  $2\frac{1}{2}$  to 3 per cent. The cost of smelting one cwt. of ore is  $7\frac{1}{4}$ d.; of one cwt. of lead, 5s.

As the ores are poor in lead and coke so expensive, it is sometimes the silver alone which pays for the cost. This furnace has an advantage over the blast furnace on account of its greater production and its not requiring a blast machine; on the other hand, it occasions a waste of fuel and causes greater loss of metal, and therefore is not suitable for working rich ores; neither are poor and difficultly fusible ores fit for it; the conduct of the process requires great experience and attention.

This furnace has given good results in smelting carbonate of lead, which cannot be worked advantageously in blast

furnaces, and in smelting the residues of reverberatory furnaces.

The cost of one cwt. of lead, when working residues and poor ores containing only from 9 to 18 per cent of lead, amounts to from 3s. 6d. to 4s. 9d.; when working argentiferous ores with a medium percentage of metal, to from 4s. 9d. to 5s. 11d.; and when working ores with 35 to 40 per cent down to 20 per cent, to about 5s. 6d. In the reverberatory process the expense is about 3s.

The loss by volatilisation is seldom less than 5 or 6 per cent, but it is considerably lessened by condensation chambers; the yield from the smoke, containing from 30 to 40 per cent of argentiferous lead, is estimated to be 7 or 8 per cent of the worked materials; the vitreous slags containing 1 or  $1\frac{1}{4}$  per cent, seldom as much as 2 per cent of lead, are thrown aside.

#### REDUCTION OF SULPHATE OF LEAD.

Sulphate of Lead seldom occurs in nature in large quantity, and is usually worked together with sulphuretted ores, without modifying the smelting process; sometimes the artificial sulphate of lead produced in calico works by decomposing sulphate of alumina by acetate of lead, has to be treated by a smelting process. This operation is performed either in *reverberatory furnaces* or in *cupola furnaces*.

Only rich substances, such as the artificial sulphate of lead, can be treated in reverberatory furnaces, which always cause a great loss of metal when the sulphate is not mixed with galena (Poullaouen), but is worked by itself.

The following method is recommended by Rivot and Phillips:—

Artificial sulphate of lead, containing a little excess of sulphuric acid, is heated in an English roasting reverberatory furnace till no more sulphuric acid is evolved; it is then mixed with 20 per cent of quartz and  $1\frac{1}{2}$  per cent of pulverised coal, and heated in an English copper matt furnace, at a gradually rising temperature, till the whole mass fuses, and till no more sulphurous and sulphuric acids are expelled by the quartz. This takes about three hours when working a charge of a ton.

The coal assists the decomposition of sulphuric acid, and extracts some metallic lead.

The product chiefly consists of silicate of lead, and may be decomposed for the extraction of the contained lead.—

*a. By Metallic Iron*, in the form of scrap iron, &c. About 15 per cent of this is uniformly distributed over the surface of the smelting mass, and repeatedly stirred up with it. This will cause the formation of metallic lead, and of slags containing silicate of iron, which are tapped off together with the lead, and are worked again in a high cupola furnace if they contain as much as 18 or 20 per cent of lead. This process of decomposition is finished in about five hours. If it is continued longer, and if more iron is added, it will be possible to produce poorer slags, but in this case the volatilisation of lead, already very great, increases, and the consumption of materials is greater. A ferruginous lead may also be formed, which would have to be treated by a refining process. The resulting scum which contains iron and lead is mixed with the charge in the next operation. From a dried sulphate containing from 65 to 68 per cent of lead, only 50 per cent is produced, 6 per cent remaining in the slags, and 10 per cent being volatilised; therefore the fume must be collected and added to the sulphate of the next charge. When calculating the yield from slags and fume, from 58 to 59 per cent of lead is produced from the dried sulphate, giving a loss of 9 or 10 per cent. As the consumption of fuel, iron, and iron tools is very considerable in the different operations, this process is applicable only to rich substances.

*b. By Charcoal, Coke or Coal, and Lime.*—The pasty mass is mixed as uniformly as possible with 10 per cent of lime in small pieces, and 8 per cent of fuel, heated till completely liquid, and then tapped off. Purer lead is obtained than when using iron, but at the same time richer slags are produced; these have to be re-smelted, and the volatilisation of lead is considerable.

*c. By Iron Pyrites.*—If from 20 to 22 per cent of this substance is mixed with the silicate of lead, metallic lead,

silicate of iron, and sulphurous acid will be produced, the excess of sulphur being volatilised :

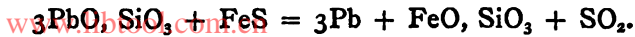

If iron pyrites is added in excess, poorer slags will be obtained, but a matt will also be produced which will be expensive to work up. To avoid this, the pyrites must be mixed well and uniformly with the silicate, so that the former is in no place in excess ; the slags are re-smelted in cupola furnaces. Though the reaction takes place in a very short time, yet the temperature required must be high, and therefore the volatilisation of lead is considerable.

Völckel's method for the reduction of the artificial sulphate of lead is as follows :—The substance is heated with coal in a Carinthian reverberatory furnace with an inclined hearth, in order to convert part of it into sulphide of lead, which is made to react upon the undecomposed sulphate, producing metallic lead. The yield of lead is about 60 per cent, and the resulting slags are re-smelted with an addition of refinery cinders.

At Poullaouen, the artificial sulphate of lead is added to the mixture when smelting argentiferous galena by the French method ; in this case the roasting process is either shortened or altogether omitted.

Smelting in cupola furnaces is more suitable for poor sulphates, as it produces poorer slags, causes less loss of lead by volatilisation, and the consumption of material is small. Such a process is used in some smelting works in Southern France, where sulphate of lead, with a gangue of lime and clay, is worked ; the ore is heated in a reverberatory furnace with two hearths, till it cakes, and, if required, enough quartz is added to form silicates containing at least 30 per cent of silica.

The caked, porous mass is smelted, together with lead products and impure slags, in furnaces from 1·5 to 2 metres high, and with an addition of enough ferruginous substance (refinery cinders, or roasted iron ore) to form an easily fusible slag containing from 44 to 45 per cent of silica. When using higher furnaces, the porous mass becomes already

reduced in the upper part of the furnace, and causes a volatilisation of lead. In operations of from 17 to 18 days, about 25 or 30 parts of coke are used for every 100 parts of ore smelted, and for caking 10 parts of ore, about 25 or 30 of coal are consumed. The yield of lead is about 80 per cent of the quantity contained in the ore, whilst the yield of poor ores in reverberatory furnaces amounts to only 45 per cent.

If a more complete desulphurisation is required, the mass must be completely scorified, instead of only caked; but sometimes the other minerals present in the ore make such a scorification unavoidable. In that case it is preferable to smelt the ore in furnaces from three to four metres high, as then a reduction of lead cannot easily take place in the upper part of the furnace; higher furnaces also allow a saving of fuel.

#### TREATMENT OF OXIDISED SMELTING PRODUCTS.

These are chiefly **Litharge, Dross, and Hearth Bottoms**, besides some lead slags. They are worked either with lead and silver ores, or by themselves in reverberatory, cupola, or hearth furnaces. Upon adding a percentage of iron pyrites, the greater part of the copper they contain may be, by these smelting processes, concentrated in a matt.

#### Reduction of Litharge.

As litharge is nearly pure oxide of lead, with only small amounts of copper, silver, antimony, arsenic, iron, &c., its reduction is effected by any of the three above-named furnaces, the choice depending chiefly on the quality and the price of the fuel, and on the smelting process which has been used in working the lead ores.

The production of lead in a certain time, as well as the ultimate yield of lead, is larger in cupola furnaces than in reverberatory and hearth furnaces, and consequently the price of labour is lower; on the other hand, the lead produced from impure litharge in cupola furnaces at a high temperature, is of inferior quality, containing more copper and antimony than that produced in reverberatory and hearth furnaces, which allow the use of raw fuel, whilst the former require coked fuel. The loss of lead in cupola furnaces

usually amounts to from  $1\frac{1}{2}$  to  $2\frac{3}{4}$  per cent ; in reverberatory furnaces from 3 to 5 per cent ; and is still greater in hearth furnaces. When litharge in the form of powder is reduced in cupola furnaces, the loss of lead exceeds that in reverberatory furnaces, which is usually somewhat larger on account of the greater volatilisation and scorification by the coal ash.

#### Reduction of Litharge in Reverberatory Furnaces.

The reduction furnaces are usually of smaller dimensions than the furnaces for smelting ore. Those used are—

*a.* Reverberatory furnaces with an inclined hearth, from which the lead continually flows out, either from the short side of the furnace situated opposite to the grate (Holzapfel), or from one of the long sides of the furnace (England).

*b.* Reverberatory furnaces furnished with a sump on the short side of the furnace beneath the flue, from which the lead is ladled.

The products are—

*a.* Lead, either marketable, or treated according to its purity and amount of silver ;

*b.* Slags, mostly treated with the remnants of the ore smelting in slag hearths, or worked again in reverberatory furnaces mixed with coal and fluxes.

#### Illustrations of the Litharge Reduction Process.

In England the reduction of litharge is carried on at different places with little modification in the construction of the furnaces, as is shown by the following examples :—

FIG 59.

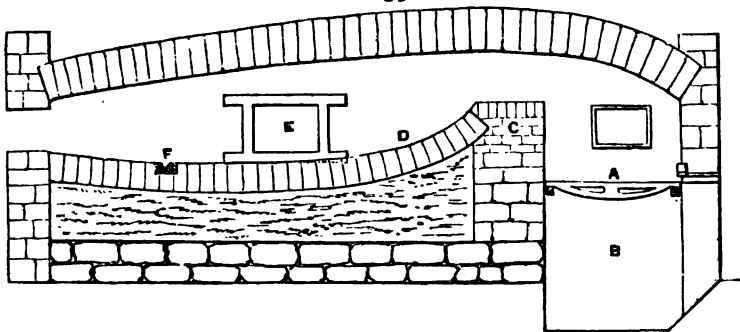
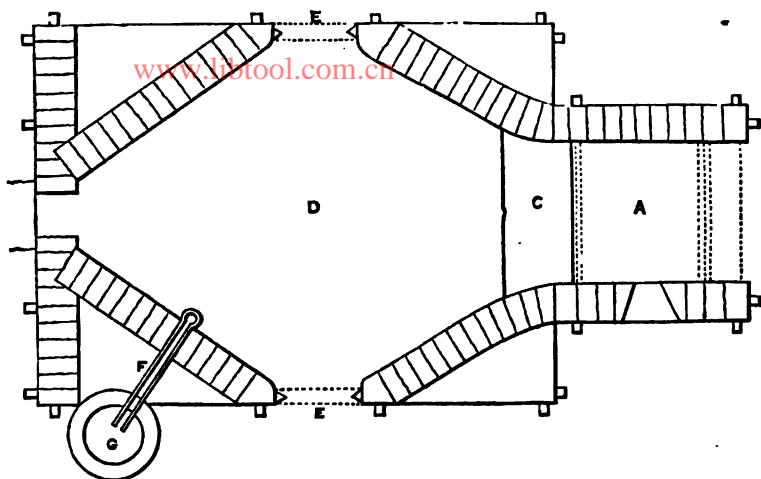

FIG. 60.



Figs. 59 and 60 represent a vertical section and plan of a reducing furnace. A, is the fire-place; B, the ash-pit; C, the fire-bridge; D, the hearth; E, the working door; F, the iron gutter for leading the reduced metal into the lead pot, G, which is kept heated by a fire beneath. A furnace of this kind, having a sole eight feet long and seven feet wide, will reduce about  $5\frac{1}{2}$  tons of lead from litharge in 24 hours.

The litharge is intimately mixed with about 10 per cent of small coal, and is charged on the part of the hearth immediately in front of the fire-bridge. To prevent the fused oxides from attacking the bottom of the furnace, and also to provide a sort of hollow filter for the liquid metal, the sole is covered with a layer of bituminous coal.

The heat of the furnace quickly effects the ignition of this substratum, which is rapidly reduced to the state of a spongy cinder. The reducing gases present in the furnace, aided by the coal in the charge itself, cause the reduction of the oxide, which flows through the interstices of the cinder in a metallic form, and ultimately finding its way into the depression at the extremity of the hearth, flows through the iron gutter into the external cast iron pot. The surface of the charge is frequently stirred up with an iron rake during the process of reduction, for the double purpose of exposing new



surfaces to the action of the gases and of allowing the reduced lead to flow off more readily. Fresh quantities of litharge, with small coal, are thrown in from time to time as the previous charge disappears; and at the end of the shift, which usually extends over 12 hours, the floor of cinder is broken up, and after being mixed with the residues in the furnace, is withdrawn. A new floor of cinders is then made, and the operation proceeds as before. The yield is 89 per cent of lead;  $4\frac{1}{2}$  tons are produced in 24 hours, with a consumption of one ton of coal.

The expense of reducing one ton of litharge may be estimated as follows:

	£	s.	d.
Labour . . . . .	0	2	6
Coals (3 cwts.) . . . . .	0	0	5·2
Repairs . . . . .	0	0	1·6
Total . . . . .	£0	3	0·8

At Deebank, in North Wales, the reduction furnace has an oval hearth, 3·5 metres long, 2·3 metres broad, and sloping with an inclination of 5° or 6° towards the flue, so that the hearth near the fire-bridge is 0·45 metre beneath the arched roof, and 0·6 metre at its lowest inclination (the sump). The breadth of the hearth on the fire-bridge is 1·8 metres, and on the side of the flue 1 metre. The fire-place is 0·7 metre wide and 1·2 metres long; the grate lies 1·1 metres beneath the roof, and 0·66 metre beneath the fire-bridge, which is 0·45 metre broad. The sole is formed of ferruginous sand, and rests upon iron plates supported by an arch. The flue, which is 0·3 by 0·4 metre in section, is connected with a chimney 0·6 metre square and 10 metres high.

A charge of 3 tons of litharge is mixed with 0·3 ton of small coal, and spread over the hearth of the furnace, which is still hot from the previous charge. The temperature is raised as quickly as possible to dull redness, and the lead will be extracted in about  $4\frac{1}{2}$  hours; the temperature is increased another half-hour longer, and the charge repeatedly worked with a rake till no more lead appears. The slags, which are incompletely fluid, are withdrawn by

the side doors, and are treated in the slag hearth together with the ends of the ore smelting. The lead which has somewhat cooled is ladled through the working door into moulds; this takes about one hour. Three tons of litharge yield 2.7 tons of lead in pigs, and 12 tons of litharge are reduced in 24 hours, consuming 1.4 tons of coal. The yield of lead amounts to from 89 to 90 per cent; about 3 per cent of slags also result, which contain from 45 to 50 per cent of lead.

At Holzappel, in Nassau, Carinthian reverberatory furnaces are used for reducing litharge, partly to make use of the brushwood which abounds in the neighbourhood, and partly to obtain a purer lead. The hearth of the furnace, 13 feet long and 8 feet broad, is covered about 3 inches high with small charcoal, except the space near the front of the furnace, which is about 2 feet broad; after these have been ignited, about 6 cwts. of litharge, not too finely crushed, are laid evenly upon the charcoal layer, and covered again with a layer of coal. This is exposed to the action of a low temperature for about  $1\frac{1}{2}$  hours, and then the mass is stirred, turned and pressed, still at a moderate temperature, in order to keep the charge in the form of powder. The reduced lead flows into a sump constructed outside the furnace, which is kept covered with glowing coals. The residues are heated till they cake, and are withdrawn after a shift of 12 hours; 4 cwts. of them are mixed with about 1 cwt. of refinery cinders, the hearth of the reverberatory furnace, and 12 cwts. of lead slags, and are treated for the production of hard lead. From 30 to 40 cwts. of litharge are reduced in 24 hours, yielding 82 per cent of lead, besides the lead contained in the residues. The loss of lead is said to amount to 8 or 10 per cent.

At Poullaouen\* the reduction process is carried on in French reverberatory furnaces. 5 tons of litharge are worked in 12 hours, consuming 150 cubic feet of wood, and about 9 cubic feet of coal, and yielding 80 per cent of lead. The residues are again treated by the cupola furnace process.

\* B. u. h. Ztg., 1859, p. 351.

At the smelting works in Ems, only part of the litharge is reduced (in 1861 about 38 per cent), the other part is sold as it is. The process is conducted in Carinthian reverberatory furnaces, and from the 5 tons of lead contained in the litharge, there were obtained 86.77 per cent of very pure lead, and 9.29 per cent of lead in the residues, causing a loss of 3.94 per cent.

**Reduction of Litharge in Cupola Furnaces.**—Moderately high cupola furnaces (half-blast furnaces) are employed for the reduction of litharge, oftener than high cupola furnaces. They are mostly constructed like sump furnaces (Freiberg, Upper Hartz), though sometimes like a channel furnace with a closed eye (Upper Hartz, Tarnowitz, Lower Hartz), and in rare cases like crucible furnaces (Przibram).

The more compact and large the lumps of litharge, the higher the furnaces which may be employed. High furnaces cause a saving of fuel, and the production of poorer slags; the process takes a shorter time, produces less slag, and admits of longer operations. But if the furnace is too high, a more impure lead will be produced.

Porous litharge, and litharge in form of powder, must be worked in low furnaces; when in the form of powder, litharge should be moulded with an addition of clay into bricks, previous to its reduction.

The smelting process must be carried on without flame at the mouth of the furnace, and with a short nose. Its progress may be chiefly judged by the nature of the slags, which should be pasty and vitreous; as soon as they become too easily fusible, a smaller charge is added. If litharge is added in too large a quantity, it will be found swimming upon the lead. The process is carried on with charcoal or coke, seldom with coal or turf; charcoal is preferable to coke; the application of hot blast has been found to possess no benefit.

The products resulting from this operation are lead, slags, and dross.

## Illustrations of the Reduction of Litharge in Cupola Furnaces.

[www.libtool.com](http://www.libtool.com)

At the smelting works of the Upper Hartz, low furnaces were formerly used, but of late higher furnaces constructed as sump furnaces are employed; they are represented by Figs. 37, 38, 39, 40, and 41, as shown on pages 101, 102, 103, and 104. The horizontal tuyere has a diameter of  $2\frac{1}{2}$  inches, and the pressure of blast is equal to 7 lines of mercury.

One charge consists of 174 lbs. of litharge in lumps, 20 lbs. of slags from the same process, and 25 lbs. of charcoal. In one operation of about 60 hours eight or nine smeltings are effected, care being taken to keep the furnace mouth dark, to have a nose from five to six inches long, and to form pasty slags. One smelting consists of from 184 to 187 cwts. of litharge, and 21 cwts. of slags from the same process. 5 tons of litharge, containing 92 per cent of lead, yield  $4\frac{1}{2}$  tons of lead, with 0.00375 per cent of silver; 1.6 cwts. of slags, with about 9 per cent of lead; 11 cwts. of slags, which are used for the same process; 2.4 cwts. of lead dross, with 75 per cent of lead; and 0.4 cwt. of metallic smoke, with 78 per cent of lead; and they consume 11 cwts. of charcoal and 11.5 cwts. of slags.

The composition of the reduced lead is shown by the following analyses:—

Lead from Clausthal, analysed by Streng, contained 99.647 per cent of lead, 0.122 per cent of copper, 0.225 per cent of antimony, 0.005 per cent of iron, and 0.001 per cent of tin. Lead from Altenau, by Jordan: 97.69 per cent of lead, 0.09 per cent of copper, 1.34 per cent of antimony, 0.58 per cent of iron and tin. Lead from Lautenthal, by Streng: 99.67 per cent of lead, 0.07 per cent of copper, 0.24 per cent of antimony, 0.005 per cent of iron, and 0.015 per cent of tin.

The slags from this process are composed as follows:—

Slag from Clausthal, analysed by Brülé: 28.75 per cent of silica, 44.6 per cent of oxide of lead, 6.87 per cent of protoxide of iron, 0.42 per cent oxide of manganese, 0.21 per

cent of suboxide of copper, 8.92 per cent of alumina, 7.83 per cent lime, 0.53 per cent magnesia, and 0.7 per cent oxide of antimony.

Slag from Pontgibaud, according to an analysis by Berthier, consisted of 22.0 per cent of silica, 35.6 per cent of oxide of lead, 4.2 per cent of oxide of iron, 5.2 per cent of alumina, 30.2 per cent of lime, and 1.0 per cent of magnesia.

The resulting dross is reduced in 18 hours in quantities of about 12½ tons in one operation, with 18 cwts. of slags from the reducing process, and 2,480 lbs. of charcoal, producing 184 pigs of lead, and 26 cwts. of slags. On refining these 184 pigs, there are produced in 15 hours 12 tons of dross lead, containing 0.0035 per cent of silver, and about 1 ton of cupriferous refining dross, which is worked in the last lead matt smelting. The total yield of lead from the reducing process of the litharge and dross amounts to 90 per cent, and the loss of lead to 2 per cent.

The dross lead is composed as follows:—

Lead from Clausthal, analysed by Streng: 98.30 per cent of lead, 0.16 per cent of copper, 1.20 per cent of antimony, 0.10 per cent of tin; its specific gravity = 11.383. Lead from Altenau, by Ulffers: 99.60 per cent of lead, 0.016 per cent of copper, 0.370 per cent of antimony, 0.006 per cent of iron, 0.001 per cent of tin; its specific gravity = 11.350.

The litharge of the smelting works at the Lower Hartz\* is more or less cupriferous, contains from 86 to 90 lbs. of lead and 0.03 oz. of silver per cwt., and is reduced in low cupola furnaces six feet high, constructed like channel furnaces with a closed eye. It is mixed with ¼ of its weight of slags from the same process, and smelted with the mouth of the furnace kept dark and the tuyere bright. In operations of from 16 to 20 days, about 7 or 7½ tons of litharge are reduced with charcoal, producing about 4½ tons of lead and from 4 to 6 per cent of slags.

At the Freiberg smelting works,† double furnaces, eight

\* KERL, die Rammelsberger Hüttenprocesse, 2 Aufl, 1861, p. 65.

† KARSTEN'S Archiv., I R., ix., 232. PLATTNER'S Vorlesungen, herausgegeben von Richter, ii. 129.

feet high, are employed, and about 45 tons of litharge from unrefined raw lead are reduced in 24 hours, yielding  $4\frac{1}{2}$  tons of lead per 5 tons of litharge; only 25 tons of litharge can be reduced in 24 hours if it is derived from the rich lead which had been treated by Pattinson's process; and only 15 tons of this rich litharge if obtained at the latter part of the cupelling process. This is worked with an addition of 10 per cent of slags, as it contains a certain amount of the hearth bottom.

The resulting slag contains from 25 to 30 per cent of lead, and, at the end of the operation, is worked in admixture with 3 per cent of iron pyrites. From this smelting there results, first, slag lead, which is refined by Pattinson's process; second, matt and slags (modified slags), containing 5 per cent of lead; these are worked up again in the lead smelting process. If they are black and vitreous in appearance, they are either a mixture of mono- and bi-silicates (*a*, from the Muldner smelting works), or a bi-silicate (*b*, from the Halsbrück smelting works). According to Richter, their composition is as follows:—

SiO <sub>3</sub> .	Al <sub>2</sub> O <sub>3</sub> .	CaO.	MgO.	FeO.	PbO.	Cu <sub>2</sub> O.	S.	Coke mechanically intermixed.
<i>a.</i> 36.66	6.12	5.76	1.43	30.42	8.38	1.07	3.21	7.32
<i>b.</i> 52.00	7.40	8.63	0.81	25.11	3.10	0.18	0.51	2.10

The application of turf and hot blast\* and also the construction of the furnace like channel furnaces with a closed eye † have given no good results.

In order to diminish the loss of lead, lumps of coke are arranged over the mouth of the furnace; the escaping gases and flame ignite the coke, and the oxide of lead passing through it becomes reduced, and the metal drops back into the furnace.

At Przibram, ‡ 10 tons of litharge are reduced in 24 hours without any addition of flux, in low furnaces five feet high. The lead is not tapped off, but runs continually out of the tap-hole on to the hearth as the reduction proceeds rapidly.

\* Freiburger Jahrb., 1834, 1840.

† Ibid., 1839.

‡ Oesterr. Ztschft., 1856, p. 350.

One operation lasts 10 or 12 days. From 57 tons there are produced 2 cwts. of litharge, containing 90 per cent of lead, 43 tons, 15 cwts., 16 lbs. of soft lead; 8 tons, 19 cwts. of slags, containing 60 per cent; 1 ton, 2 cwts., 71 lbs. of pot dross, containing 80 per cent; and 10 cwts. of furnace residues, containing 80 per cent of lead. The loss of lead is 1·85 per cent.

At Tarnowitz, litharge is reduced in ore smelting furnaces with coal and a flaming furnace mouth. Five tons of litharge, consuming 1 ton of coal, reduce in 7 hours 4 tons, 9 cwts. of soft lead containing 0·06 oz. of silver, and 15 cwts. of slags, dross, and residues.

### Reduction of Litharge in Hearth Furnaces.

Scotch hearths and Siberian reducing furnaces are used for this purpose. The process is conducted in the Siberian reducing furnace as follows:—The furnace, which is of very small dimensions, is filled with glowing coals and put before the cupelling furnaces, and the litharge as it flows off is made to run direct into the small reducing furnace, causing the reduction to take place at a low temperature, and consuming a comparatively small quantity of fuel. Whilst skimming off the first dross the reducing furnace is either not brought close up or is closed with an iron plate covered with marl. If the process of forming litharge is interrupted by an after-charge of lead, the reducing furnace is likewise covered with the iron plate.

Although very simple and inexpensive, this plan has the following disadvantages:—

1. In the cupelling process a highly argentiferous litharge is likely to be produced, as the workman is prevented observing whether any lead runs out with the litharge, whilst in the usual process the metal is clearly visible on the solidifying litharge. When the lead produced from litharge is to be desilverised, this disadvantage is of no consequence (Hungarian smelting works).

2. The workmen are more exposed to heat and lead fume.

3. The manipulations in the cupelling furnace have to be conducted at a greater distance, interfering with an exact observation of the process; this is chiefly occasioned by the lead fume escaping from the reducing furnace.

These disadvantages have prevented a general introduction of the process, although it has often been tried at Freiberg,\* Tarnowitz,† Upper Hartz,‡ Schemnitz,|| &c.

At Barnaul,§ in Siberia, the reducing furnace is two feet high and 12 inches broad and deep. It is composed of cast iron plates, three of them cast into one piece, resting upon an iron bottom plate. The fourth plate, which is fixed against the three plates, is furnished with an opening forming the front of the furnace. The sole of the furnace has a sump from which the lead is conducted, by means of a moveable spout, into pans which are placed round the furnace.

At Fernezely¶ (Hungary), the litharge is reduced in small cast iron furnaces, 30 inches high, 16 inches broad, and 18 inches wide; the front wall is pierced with circular holes, and placed about two inches deep against a sloping channel, which conducts the lead to a crucible situated in the sole of the smelting house. The crucible is kept filled with charcoal; the air required for combustion enters through the lower part of the furnace, and by the holes in the front wall. This furnace produces about 70 per cent of the cupelled lead, and a variable quantity of dross and residues. 9 cwts. of lead require about 12 cubic feet of charcoal.

The process of reducing litharge in Scotch furnaces is very simple, consuming little fuel, but causing a great loss of lead if not furnished with ample condensation chambers.

At the smelting works at Bottino, in Tuscany, from about 6 tons 6 cwts. of second litharge, 5 tons 6 cwts. of marketable lead, and 12 cwts. of poor slags were produced.

\* KARST. Arch., 2 R., xi., 232.

† Polyt. Centrbl., 1836, No. 50.

‡ KERL, Oberh. Hüttenpr., 1860, p. 605.

|| KARST. Arch., 2 R., ix., 228.

§ KARST. Arch., 2 R., ix. Polyt. Centrbl., 1836, No. 50.

¶ Jahrb. d. K. K. geol. Reichsanst., 1853, No. 3, p. 610, 612.



In the same operation about  $4\frac{1}{2}$  cwts. of third litharge, and  $10\frac{1}{2}$  cwts. of dross were reduced, giving 12 cwts. of lead for the cupelling process, and 2 cwts. of rich slags; the total consumption of coal amounted to about 34 cwts. The slags are re-smelted in cupola furnaces.

At Pezey and Pontgibaud the Scotch furnaces yielded 89 per cent of lead from litharge.

### REDUCTION OF THE DROSS.

When smelting very impure raw lead in cupelling furnaces, even before starting the blast engine, a dark crust is produced on the bath of metal, consisting chiefly of sulphuretted and oxidised metals and earthy substances, as well as some raw lead mechanically intermixed. If this crust is formed in considerable quantity, it is skimmed off from the metal bath, and goes by the name of *abzug* (Lower Hartz). When smelting purer lead, the crust is not skimmed off, but changes into an oxidised slag-like mass (black litharge), chiefly containing those substances which have a greater affinity for oxygen than is possessed by lead, such as antimony, arsenic, iron, zinc, &c. A small quantity of sulphur, which always retains copper and silver, causes the dark colouration of the black litharge at the beginning of the period; as the foreign substances are removed, the litharge becomes richer in oxide of lead, and assumes a more yellowish green colour.

This black litharge will give, when submitted to a reducing smelting, a more or less antimonial hard lead, which is chiefly used for the manufacture of printing type, shot, &c.

To separate the raw lead which is mechanically intermixed with the dross, and to reduce part of the oxide of lead in order to concentrate the antimony into the remaining part, the dross is sometimes submitted to a refining process in a cupelling furnace before it undergoes reduction; in this case the hearth of the cupelling furnace is made of small coal mixed with loam, and some marl or sand.

The dross is mostly reduced in the furnaces which were

used for the reduction of litharge, but cupola furnaces are preferable, and a saving of fuel and a greater yield of metal have been effected in high furnaces. The process of reducing dross is slower than that of reducing litharge, as the dross is more difficult to fuse, and requires some addition of slag; poorer slags result when using coke instead of charcoal.

The chief products are—

a. **Hard Lead**, which is either sold as such or refined. Its composition is shown in the following analyses:—

	Pb.	Sb.	As.	Cu.	Fe. Zn.
1.	85'34	14'06	—	0'50	0'10
2.	77'36	22'75	—	—	—
3.	86'34	12'98	—	0'68	—
4.	83'91	16'01	—	0'04	0'04
5.	91'80	3'98	3'24	0'69	0'12
6.	94'73	2'02	1'92	0'48	0'11
7.	82'40	10'04	3'00	2'28	1'08
8.	84'10	14'60	—	1'20	—
9.	81'27	16'40	—	2'29	0'04
10.	91'40	8'20	0'40	—	—
11.	95'60	2'40	—	trace	—
12.	93'00	7'00	—	trace	—

Nos. 1 to 4 are from the Upper Hartz, 5 and 6 from Freiberg, 7 and 8 from the Lower Hartz, 9 from Holzappel, 10 from Katzenthal, 11 from Villefort, 12 from Pezey.

b. **Slags**, varying in the amount of lead they contain.

### Illustrations of the Processes for the Reduction of Dross.

At the smelting works of the Upper Hartz, the dross resulting from the middle smelting period contains from 80 to 86 per cent of hard lead and 0'0012 per cent of silver; it is fused upon a foundation of brush-wood, and in cupelling furnaces without the application of blast, in quantities of 3 tons, 6 cwts.; the smelted mass is tapped off into a basin in which the raw lead collects, whilst the dross runs over the border of the hearth on to the sole of the smelting house. The result from 3 tons, 6 cwts. of dross is about 12 cwts. of

raw lead containing 0·02 per cent of silver, consuming from 360 to 420 bundles of brush-wood, each bundle being 42 inches long and 30 inches in circumference. The porous dross is then broken into pieces and treated in the litharge reducing furnaces. One charge consists of 40 lbs. of coke,  $1\frac{1}{2}$  cwts. of dross, and 50 lbs. of matt slag from the reducing smelting. 25 tons of dross with 1 ton of reducing slags and 12 cwts. of matt slag are treated in four days, consuming 4 tons, 11 cwts. of coke, and 11 cwts. of charcoal, and producing—

1. Fifteen tons, 18 cwts. of **Hard Lead**, containing 0·001 to 0·0025 per cent of silver; this has little or no ductility, emits a clear sound when struck, has a granular fracture, and solidifies in the moulds much more slowly than common lead produced by the reducing process.

2. **Slags**, containing 0·0005 per cent of silver and from 9 to 10 lbs. of lead per cwt.; these are re-worked in the same process together with the metallic fume.

At the smelting works of the Lower Hartz,\* the black litharge contains at the commencement of its formation 80 or 82 per cent of lead, 4 or 6 per cent of antimony, and  $\frac{1}{4}$  or  $\frac{3}{8}$  of oz. of silver per cwt.; it is reduced in the same way as the litharge, with charcoal and an addition of  $\frac{1}{4}$ th of unrefined copper ore slags. 5 tons consume 160 cubic feet of charcoal in 24 hours, and produce—

1. About  $2\frac{3}{4}$  tons of **Hard Lead** containing 0·437 oz. of silver when charcoal has been used, and 0·468 oz. of silver when coke has been used.

2. From 10 to 16 cwts. of **Slags**, containing 15 or 20 per cent of lead by using charcoal, and 4 to  $4\frac{1}{2}$  per cent of lead when using coke. These slags are either worked together with the lead ore, or treated by themselves with coke; the resulting hard slag lead contains up to  $\frac{1}{2}$  oz. of silver, the slags 4 or 5 per cent of lead.

As the raw lead in these works is very impure, the first dross is removed separately and treated by itself for the extraction of its silver, copper, and lead. This process is

\* KERL, Unterharzer Hüttenpr., 1861, p. 67.

very much like the process for reducing litharge. The first dross and black litharge, containing from 74 to 88 percent of lead and  $1\frac{1}{2}$  or  $2\frac{1}{2}$  oz. of silver, yield by it—

1. **Raw Lead** with about  $1\frac{5}{8}$  oz. of silver, which is refined, and the residues are treated for the production of a matt containing 40 or 50 per cent of copper.

2. **Matt** containing 40 or 50 per cent of plumbiferous copper, which is worked for the production of copper.

3. **Slags**; these are treated according to the amount of metal they contain.

At Przibram\* the dross (black litharge) is re-smelted in lots of 3 tons 15 cwts. in 20 or 22 hours, giving raw lead containing 1 or  $1\frac{1}{2}$  ozs. of silver, and slag (refined dross) containing 56 or 60 per cent of lead. This refined dross is reduced like litharge in cupola furnaces. From 31 tons 17 cwts. of refined dross with  $11\frac{1}{2}$  tons of slags from the same process, together with 11 tons, 9 cwts. of iron refinery cinders and 3,890 cubic feet of charcoal, were produced 15 tons of hard lead and 17 tons 7 cwts. of slags.

At Freiberg different modes of treating the dross are used according to its composition.

1. Dross rich in antimony is reduced like litharge with a small addition of old lead slags, producing hard lead and slags.

2. Dross containing much copper is treated with an addition of old lead slags, and pyritic residues or magnetic iron ore, and with coke, giving lead, matt and slags.

3. Dross resulting from the cupellation of rich lead is added to the mixture at the lead smelting process.

At Holzappel the dross is treated as at the Upper Hartz. Hard lead fit for shot is produced by reducing the dross resulting from the treatment of litharge in reverberatory furnaces.

At Müsen the second dross is reduced; 5 tons producing 4 tons of hard lead, with a consumption of 15 cwts. of coke. 1 ton, 15 cwts. of the slags from this process yield 3 cwts. of

\* Oesterr. Ztschr., 1858, p. 349. B. u. h. Ztg., 1843, p. 807.

hard lead, consuming 22 cubic feet of coke and 3 cwts. of iron cinders.

At the smelting works at Ems the dross is treated in a Carinthian reverberatory furnace, and from the 5 tons of lead contained in the dross there result 62·08 per cent of hard raw lead, and 36·2 per cent of lead in the residues. The loss is 1·72 per cent. The residues are treated in cupola furnaces for the production of marketable hard lead ; the hard raw lead is cupelled in lots of  $1\frac{1}{4}$  tons.

#### TREATMENT OF THE BOTTOMS OF FURNACES.

The hearth of a cupelling furnace, consisting chiefly of marl and wood-ash, or lime and clay, will always be found impregnated with oxide of lead after having been used. This hearth is only in rare cases worked up by itself ; most frequently it is added to the mixtures for other smelting operations. It is worked by itself in some Siberian smelting works,\* being smelted in reverberatory furnaces with old slags and scrap iron.

At Tarnowitz the hearth from the cupellation of poor lead is worked for the production of marketable lead, and that from the cupellation of rich lead for producing raw lead.

#### REDUCTION OF LEAD SLAGS.

The richer slags are usually worked up in other processes, often without considering the injurious influence this has upon the quality of the resulting metal.†

On the other hand, a separate smelting process for extracting the greater part of the lead from the slags does not always give good results, as the price of fuel, lead, and labour has to be considered, as well as the amount of lead contained in the slags.

The lead in slags, being combined with silica, requires

\* Oesterr. Ztschr., 1854, p. 410.

† TUNNER, Jahrb., 1852, ii., p. 270.

fluxes containing strong bases, such as lime, protoxide of iron, &c., and high temperatures, by which the consumption of fuel is increased. If the mixture is too easily fusible, the reduction of the oxide of lead will be incomplete, or if the fusibility is caused by ferruginous substances, deposits of iron will be separated, thus injuring the process. When the mixture is too difficult to fuse, the great amount of fuel required renders the process very expensive. Coke is preferable to charcoal, and the hot blast has been sometimes advantageously applied.

Occasionally it is advisable to smelt the slags with pyritic ores for the production of raw matt (Freiberg), or also, by a small addition of pyrites, to concentrate in a matt the copper contained in the slags. The process may be carried on both in cupola and in reverberatory furnaces.

### Illustrations of the Processes for the Reduction of Lead Slags.

At the smelting works near Freiberg, the lead ore slags are treated in reverberatory furnaces for the production of raw matt, and the slags from the litharge and dross reducing process are treated in admixture with pyrites for the production of lead and matt.

At Tarnowitz, the ordinary slags are treated in cupola furnaces with iron refinery cinders, and sometimes with metallic iron.

At the Saigerhütte, near Hettstädt (Mansfeld), old lead slags, containing from 10 to 13 per cent of lead, are worked in a cupola furnace 14 feet high; the profit is very small.

In several smelting works in the province of Iglesias,\* in the island of Sardinia, old lead ore slags, containing from 11 to 18 per cent of lead and 0.35 oz. of silver in 2 cwts., and litharge reduction slags, containing up to 43 per cent of lead and 0.2 oz. of silver per 2 cwts., are worked. For instance, at the smelting works in Domusnovas, nine cupola furnaces are used for the smelting of slags. These

\* Oesterr. Ztschr., 1861, p. 395.

furnaces are 4·5 metres high above the tuyere; some have two and three tuyeres.

The slags are composed as follows:—

[www.libtool.com.cn](http://www.libtool.com.cn)

SiO <sub>3</sub>	. . . . .	29·00
PbO	. . . . .	16·00
FeO	. . . . .	28·05
SbO <sub>3</sub>	. . . . .	3·50
ZnO	. . . . .	0·40
Al <sub>2</sub> O <sub>3</sub>	. . . . .	12·00
CaO	. . . . .	1·55
FeS	. . . . .	9·50

In 24 hours about 8 tons are treated with 6 per cent of iron borings and cast iron, producing 10 or 11 per cent of lead, at a consumption of 15 or 17 per cent of oak charcoal.

Serpieri has founded in Cagliari the first works for smelting Sardinian slags, and he produces 1,000 tons of lead per annum. This lead is richer in silver than that produced from galena in other works, and it has lately been treated according to Pattinson's process in the works near Genoa, which are capable of treating annually more than 3,000 tons of lead.

In different parts of Spain, in Amadir,\* near Almazaron, for instance, old Roman slags are worked.

### DIVISION III.

#### PURIFICATION OF THE LEAD.

The lead produced in smelting works is never chemically pure; it contains, according to the foreign substances associated with the ore, *copper, silver, antimony, arsenic, zinc, iron, bismuth, nickel, and sulphur*. These substances render the lead more or less hard and sonorous, and lessen its value by rendering it less applicable both for chemical manufactures and for mechanical purposes. With regard to

\* B. u. h. Ztg., 1862, p. 62.

the former disadvantage, *copper*, *antimony*, and *arsenic* are chiefly injurious, and in the latter, chiefly *antimony* and *arsenic*; for instance, the rolling of the lead is not prejudiced by a certain amount of copper,\* and the purest lead will sometimes show itself brittle at rolling in consequence of a crystalline structure (Pattinson's lead).† A small amount of oxide is said to make lead harder, as suboxide of copper does copper.‡

According to the investigations of Reich|| and Streng,§ iron enters but little into combination with lead unless the metals are some time in contact, as, for instance, when lead is melted in iron vessels. Iron is mostly separated by oxidising the surface of the metal, so that seldom more than 0·02 to 0·07 per cent of iron remains in it. The highest amount of zinc, according to Matthiessen and v. Bosse,¶ which remains in lead is 1·5 per cent.

The purer the lead the higher is its specific gravity, and the greater its softness and ductility.

In English smelting works it is regarded as an infallible sign of the purity of the lead if there is an iridescent appearance when an iron rake is moved across the molten surface, beginning at the working door. The workmen sometimes take small samples, pour them upon a hot iron plate, and observe whether the lead forms round globules or not; if no globules are formed, the lead is tolerably soft. This sign is of value if the lead contains *arsenic*, but of little use when it contains *antimony*.

The methods used for purifying impure raw lead (for Pattinson's process) or impure lead poor in silver, so as to make it marketable, are founded upon the principle either of separating admixtures difficult to fuse by a process of liquation, or of exposing the lead to the oxidising influence of the common air or of a blast, in a more or less high temperature,

\* KERL. Oberharzer Hüttenpr., 1861, p. 446.

† Ibid., p. 624.

‡ Dingler's Polyt. Journ., Bd. 32, p. 286.

|| Freiburger, Jahrb., 1860. B. u. h. Ztg., 1860, p. 28, 284.

§ B. u. h. Ztg., 1860, p. 127, 284.

¶ ERDMANN'S Journ. f. pr. Chemie, Bd. 84, p. 323.



and for longer or shorter periods, according to the quantity and quality of the foreign admixtures.

When smelting at as low a temperature as possible, iron, zinc, and copper separate almost entirely from the lead, and swim on its surface as a pasty, half-melted mass, provided the crust is repeatedly skimmed off; arsenic and antimony require a longer oxidising smelting, and sometimes the application of blast, to become partly volatilised, and partly separated as a dross-like mass on the surface of the liquid lead. The loss of lead and the expense of the process are increased by using a high temperature, by a long calcination, and by the application of a blast. Reich\* states that if cupriferous dross is kept in contact with the lead for a longer time and at a high temperature, part of the copper will again enter into combination with the lead. These different kinds of dross are afterwards treated in various ways.

**The Modes of Purification are as follows :—**

**A. Skimming the Lead.**—The lead produced by reducing litharge, and which has been tapped off into the basin, is freed by repeated skimmings from the cupriferous and antimonial dross which forms upon its surface; this goes on till the lead has attained a suitable temperature for being ladled into moulds. In England the skimming is effected by means of two wooden boards, and in Germany by an iron scraper, and is repeated till the colour of pure lead appears. This mode of purification is only effective with the purer sorts of lead containing little copper. It is sometimes assisted by mixing wood shavings and brush-wood, &c., with the molten lead, and stirring it up with them, when a development of gases will take place, causing mechanically admixed impurities to rise to the surface, and also facilitating the oxidation of the foreign substances by increasing their contact with the air. In this way the subsulphide of lead which is frequently contained in lead produced in reverberatory furnaces, rendering it pasty, may be removed, as well as the sulphide of lead, and intermixed particles of ore, &c.

\* B. u. h. Ztg., 1860, p. 284.

**B. The Liqueation Process**, chiefly used for separating the substances difficult to fuse (copper, nickel, iron, &c.), which are present in larger quantities in lead (Lower Hartz); this process is mostly conducted on the liqueation hearth, and, though very simple, is imperfect and causes great loss of metal.

**c. The Process of Stirring the Smelted Lead with a Birch Pole.**—This is done at Altenau (Upper Hartz) in the following way:—11 tons 5 cwts. of lead are melted in an iron vessel, 5 feet 6½ inches in diameter, and 2 feet 10 inches deep, for 6 or 8 hours, the impurities which rise to the top (about ¼th of the charge) are then collected together by a piece of wood, and put into moulds by means of a pierced ladle. After a lapse of half or three-quarters of an hour the surface becomes bright, and then a birch pole is moved about in the metal bath by machinery for two hours; by this manipulation the metal begins to bubble fiercely, the surface is continually renewed, and an ample separation of impurities is effected, which are removed in pierced ladles. According to Streng's investigations, the greatest part of the antimony and copper is separated by this process; this, for the not very impure argentiferous raw leads of the Upper Hartz, appears preferable to the calcination process in reverberatory furnaces, as it saves fuel, time, and labour, and also causes less loss of lead.

At the smelting works in Stadtgrund and Schemnitz\* (Hungary), the lead is liquated in a reverberatory furnace, with a sloping, tray-like sole, and is then treated with a pole, the liquated lead running into a kettle which stands outside the furnace. This mode is less expensive, the consumption of fuel is a little larger, the production is greater (the loss of lead being from 0·59 to 0·73 per cent), and the lead (*a*) is purer than from the liqueation process formerly used (*b*).

	Pb.	Ag.	Cu.	Sb.	Fe.	Zn.
<i>a.</i>	98·954	0·005	0·456	0·212	0·126	trace
<i>b.</i>	99·900	trace	0·090	—	0·009	—

\* Schemnitzer und Leobener Jahrbuch, 1862, Bd. xi., p. 130, p. 199. Berg. und Hüttenmannische Zeitung, 1857, p. 26; 1859, p. 67.

Experiments on the application of this process for the purification of the antimonial lead of Stolberg, did not succeed.

**D. Pattinson's Process.**—This crystallisation process can only be advantageously employed with the purer kinds, mostly calcined raw leads, and as it yields lead of great purity is chiefly adopted with lead rich in silver (Altenau, Freiberg). Baker calls attention to the fact that the small quantities of copper and antimony contained in lead, enter chiefly into the argentiferous mother liquor, whilst arsenic collects in the crystals. If the raw lead contains a larger amount of copper, the crystals also become cupriferous, and in this case a calcination of the raw lead is advisable.

The following analyses of lead treated by Pattinson's process will be of interest:—

	Pb.	Sb.	Cu.	Zn.	Fe.	Ag.	As.	Specific gravity.
1.	99'955	0'016	0'017	0'009	0'003	—	—	—
2.	99'897	0'040	0'020	0'008	0'035	—	—	11'395
3.	—	0'01	0'095	—	0'06	—	0'01	11'373
4.	—	0'04	0'14	—	0'02	—	0'01	11'365
5.	—	—	0'0054	—	0'0112	0'0014	—	—
6.	99'907	0'053	0'026	0'001	0'003	—	—	—
7.	99'952	0'007	0'026	0'009	0'006	—	—	—

Nos. 1 and 2, lead from Altenau (Upper Hartz). No. 3 and 4, lead from Freiberg. No. 5, refined lead from Sheffield, by Baker, from lead containing 0'0046 per cent Ag, 0'0066 per cent Cu, and 0'0065 per cent Fe (Berg. u. h. Ztg., 1857, p. 26). No. 6, lead from Eschweiler. No. 7, lead from Stolberg.

**E. Oxidising Smelting in Air Reverberatory Furnaces,** applicable to impure leads either poor or rich in silver.

In England, in many smelting works, cupriferous or antimonial leads are calcined in reverberatory furnaces, and afterwards treated by Pattinson's process. When calcining large quantities of less pure raw lead, the hearth of the furnace usually consists of a cast-iron pan with one fire-place, or with two, opposite each other (Panther Works at Bristol). When working purer lead, a furnace with a very low hearth

is sufficient (smelting works at Par in Cornwall, and at Deebank in Flintshire), or one furnished with a Pattinson's boiler, instead of a hearth (Enthoven lead works at Rotherhithe, near London). These boilers are more durable than cast-iron pans, and as the calcined raw lead is not very impure, they allow the calcination of six or eight tons in seven hours. The weight of the charges and the time for calcination vary according to the purity of the raw lead; two charges of lead, each five or eight tons, are usually worked in 24 hours. The resulting dross is either smelted for the production of hard lead (Par), or reduced in a reverberatory furnace with a sloping sole; the resulting lead is refined and treated by Pattinson's process, and the dross from the latter calcination process worked in Castilian furnace for the production of hard lead (Rotherhithe). Sometimes the dross is so impure and rich in antimony that it is not reduced, but reserved for sale (Deebank).

Lead calcining furnaces with cast-iron hearth pans\* are represented by Figs. 61, 62, and 63. Fig. 61 represents an elevation, and Fig. 62 a vertical section. Fig. 63 is the pan

FIGS. 61 & 62.

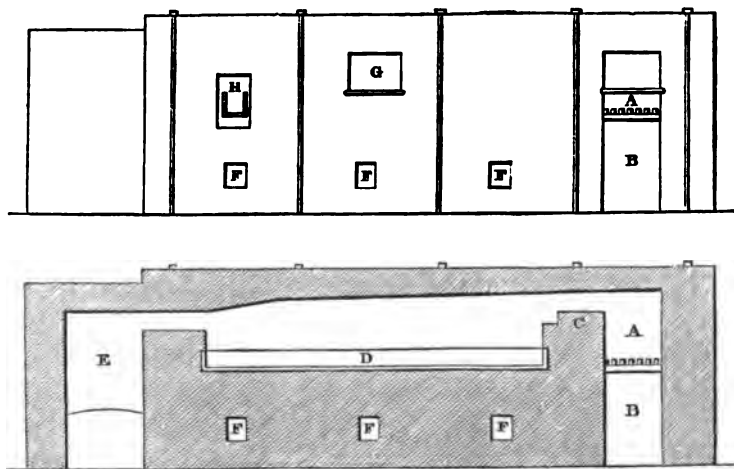

\* PHILLIPS' Manual of Metallurgy. London, 1852, p. 494. B. u. h. Ztg., 1859, p. 433. URE'S Dictionary of Arts, &c. London: 1867, vol. ii., p. 823.

FIG. 63.

www.libtool.com.cn

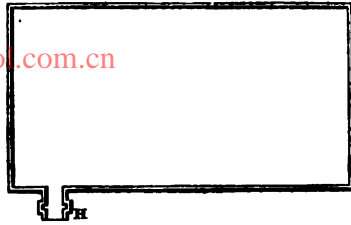

removed from the masonry, and shows a groove in the lip for the introduction of a sheet-iron dam luted with moistened bone-ash, for keeping in the fused metal. In more modern furnaces of this description, the corners are usually rounded to prevent breakage from expansion, whilst the tapping is effected by means of a hole through the bottom near one of the sides, which is closed by means of an iron plug kept in its place by a weighted lever. The pan is  $1\frac{1}{2}$  inches thick at the sides, and 3 inches at the bottom. It rests upon a support of sandstone, and the back is somewhat deeper than the front; whilst in the masonry a space of 1 inch is left lengthways, and  $1\frac{1}{2}$  inches sideways for its expansion. A is the fire-place; B, the ash-pit; C, the fire-bridge; D, the cast-iron pan; E, the flue; F F F, the channels for allowing the escape of moisture; G, the working door; H, the spout for tapping off the metal.

The fire-bridge is either solid, or provided with a vertical slit which communicates with a horizontal channel, opening over the edge of the pan and serving to introduce air.

The pan is about 10 feet long, 5 feet 6 inches wide, and 10 inches deep. The fire-place, which is 1 foot 8 inches wide, and  $5\frac{1}{2}$  feet long, is separated from the pan by the fire-bridge, 2 feet in width. The height of the arch at the bridge end is 1 foot 4 inches above the edge of the pan, whilst at the outer extremity it is only about 8 inches.

The lead to be introduced into the pan is either first fused in a large iron pot fixed in brick-work at the side of the furnace, and subsequently ladled into the furnace through an iron gutter adapted for the purpose, or the pigs of lead are thrown into the furnace when it is red hot, through the working door.

From 8 to 11, usually 10, tons of lead are charged into the red hot furnace, and at this temperature the mass is frequently and strongly stirred till the surface is covered with fluid slag about half an inch thick; three or four shovels of a mixture consisting of one part of burned lime and two parts of small coal, are now added to the mass, and stirred well into it, causing a reduction of the lead contained in the slag, by which the latter becomes stiff and dry, and may be removed by the working door. This is repeated until the lead has become sufficiently pure and soft, which is ascertained by the iridescent appearance, and by a sample assuming a peculiar crystalline structure when taken out of the furnace. According to the impurity of the lead, one calcination may take from 12 hours upwards to several weeks. The skimmed slags are reduced, the resulting hard lead is calcined, and the resulting slag, rich in antimony, is smelted for the production of the real hard lead. The cost for refining one ton of Spanish lead amounts in the north of England to about 2s. 4'4d., viz. :—

	s.	d.	
Labour . . . . .	1	11'2	}
Coals, 2'7 cwts. . . . .	0	4'7	
Repairs, &c. . . . .	0	0'5	
			2s. 4'4d.

At Stolberg, near Aix-la-Chapelle, the raw lead is calcined in a reverberatory furnace with iron hearth pan, previous to its treatment by Pattinson's process. These furnaces differ from the English furnaces in having two fire-places, one on each of the short sides of the furnace. The pan is 9 feet 5½ inches long, 6 feet 1½ inches broad, and 5½ inches deep. In the middle of one of the long sides it has a spout, 13 inches long and 4½ inches wide, for tapping off the calcined metal; the bottom of the pan is 2¾ inches thick, the edges 1¾ inches thick, and it weighs about 4 tons. The height of the arch at the middle of the furnace is 26 inches above the bottom of the pan, and 22 inches at the fire-bridges, which are 20 inches high, measuring from the grate, and 10 inches, measuring from the bottom of the pan. The fire-place is 7 feet long, and 2 feet 2 inches wide.

A charge consists of  $3\frac{1}{2}$  or 4 tons, and is smelted at a moderate temperature; the metal bath is kept for about 10 hours at a temperature somewhat below redness, which causes the impurities to separate and collect on the surface. During the first few hours of the manipulation, a stronger heat is given in order to cause a quicker removal of the impurities, and some shovels of small coal are mixed with the separated dross, which is removed as soon as it has assumed a dry, pulverulent consistency; these operations are repeated for about 10 hours, when a sufficient purity is obtained. The lead is then made to run into an iron boiler, placed before the furnace, heated by a special fire, and from this the lead is ladled into moulds holding 1 cwt. each. At Bleiberg a furnace is used which, instead of the iron pan, has a brick wall, which answers well, giving a good result, provided a mixture of marl and coal slack is strongly beaten down as a lining to the brick wall. The lead remains in the furnace for 24 hours, during which time the antimonial dross is repeatedly skimmed off.

At the smelting works at Rouet\* (Department of the Mouths of the Rhone), reverberatory furnaces with two fire-places are also used; the grates are 0.8 metre long, and 0.6 metre wide. The hearth is 4 metres long, 1 metre wide at the front, and 3 metres wide at the back. The fire-places are on the longer sides, and one working door is on the narrower side of the furnace. The hearth is made of trachytic sand, and lasts a long time. Very impure Spanish lead containing as much as 10 per cent of antimony is calcined. A calcination lasts, according to the purity of the lead, from 4 to 48 hours, and the loss of lead amounts to from 1 to 3 per cent. One charge of 8 tons of lead required 36 hours for calcination, consuming 1.4 tons of coal, and yielding 7 tons of calcined lead and 2,180 lbs. of dross.

**Oxidising Smelting in Blast Reverberatory Furnaces.** If lead contains copper, antimony, and arsenic in considerable quantities a stronger oxidation is required; this may be obtained by the application of blast, which at the same

\* Bulletin de la Société de l'industrie Minérale, St. Etienne, ii., 414, 431.

time causes a greater loss of metal. For this purpose either a cupelling furnace or a reverberatory furnace, purposely constructed for lessening the loss of metal, is used.

At the smelting works near Freiberg\* furnaces are used with hearths having a similar form to that of the furnace represented on page 139. The hearth is formed sometimes of a refractory mass, sometimes of a cast-iron pan. The pan is 10 feet long, and in its middle somewhat more than 7 feet broad, on the fire-bridge 4 feet 4 inches broad, and on the opposite side it is 1 foot broad; the working door is put on this small side. The pan is 8 inches deep in the middle, 9 or 10 inches deep in the centre of one side, where it is furnished with a spout for tapping off the metal, and 5 or 6 inches deep on the edges. It is capable of containing 5 tons of lead. Another furnace is furnished with a hearth of burned clay, which is beaten down upon iron plates; it is larger, having the capacity of 6 tons 10 cwts. of lead. An iron pot is fixed before the tap-hole, and the charging opening is on the opposite side of the furnace; the hearth is covered with a movable iron cupola.

The lead is slowly smelted, and the cupriferous metallic dross formed is removed. A low blast is then thrown in through two tuyeres which are fixed at each side of the fire-bridge, for removing the antimony and arsenic, and this blast is kept on till the lead is sufficiently pure. During this time the dross-like mass formed is repeatedly skimmed off.

The degree of purity, as well as the time required for calcination, depends on the purpose for which the lead is intended.

a. Five tons of lead which have been reduced from litharge, and which are intended for treatment by Pattinson's process, require four or five hours for calcination, consuming about 23 cubic feet of coal in 24 hours. A sample is then taken and examined as to its ductility, and by the blow-pipe; the resulting soft lead is one of the best in the market (*vide* analyses on page 135).

\* PLATTNER'S Vorlesungen, herausgegeben von Richter, ii., 137.



b. Five tons of raw lead require 10 or 12 hours' calcining for a subsequent treatment by Pattinson's process, consuming about nine cubic feet of coal.

c. Lead reduced from furnace ends and dross of the different processes, being similar in quality to hard lead, requires 60 hours or more for calcination, according to the purpose for which the calcined lead is destined.

The following analyses may prove interesting:—

1. *Lead which has been calcined in reverberatory furnaces:—*

	Pb.	Cu.	Fe.	Ni.	Sb.	As.	S.	Sp. gr.
1.	92·41	0·18	0·04	trace	5·54	1·64	0·13	10·787
2.	—	—	0·016	0·08	not determined		—	10·987
3.	97·56	0·44	0·03	0·03	0·74	0·56	—	11·162
4.	98·68	0·54	0·03	0·04	0·06	0·05	—	11·340

These four kinds of lead are slag lead from Freiberg, analysed by Reich. 1, raw slag lead; 2, the same after having been calcined for 6 hours; 3, the same after 14 hours' calcination; 4, the same after 19 hours' calcination (soft lead).\*

2. *Lead produced at Altenau from intermediate products, after treatment by Pattinson's process:—*

	Pb.	Sb.	Cu.	Zn.	Fe.	Sp. gr.
1.	98·75	0·70	—	0·13	—	—
2.	98·74	0·20	0·02	0·31	—	—
3.	99·56	—	—	0·16	0·04	11·368

1. Lead from reducing the poor scum of the 11th, 12th, and 13th crystallisation pan, by Streng; 2, lead produced from argentiferous furnace ends, taken from a crystallisation pan, by Streng; 3, lead reduced from litharge which had been produced by cupelling rich lead.†

**Calcination of Lead at the Smelting Works at Kremnitz.**—According to Bittsansky, there is contained in the calcined marketable lead—

	Pb.	Ag.	Cu.	Sb.	Fe.	Zn.
of Schemnitz	98·954	0·005	0·456	0·212	0·126	trace
„ Neusohl	97·502	0·002	0·273	0·704	0·084	trace
„ Kremnitz	98·748	0·003	0·150	0·362	0·102	trace

\* B. u. h. Ztg., 1860, p. 126.

† KERL, Oberharzer Hüttenprocesse, 1860, p. 447.

These leads may be used for common purposes, but not for the finer manufactures. Von Amon has completely purified this lead, with the exception of some traces of iron, by the following treatment:—

The lead resulting from the reducing process of litharge, is smelted in lots of 5 tons, 3 cwts., at a moderate temperature in a cupelling furnace furnished with a sloping hearth; the dross is skimmed off and is stirred with green wooden poles for  $1\frac{1}{2}$  to 2 hours, till the separating dross consists merely of yellow oxide of lead. As the copper and antimony cannot be completely extracted by this operation, some air is admitted for oxidation, at a moderate temperature, until in two or three hours the litharge running out is pure yellow. The lead is then allowed to cool and is tapped off into an outer basin, and is ladled from this into warmed cast-iron moulds. The lead must be sufficiently cooled before the ladling, as otherwise a thin covering of oxide will be formed, giving a rough, ill-looking surface to the lead.

The loss of lead in this calcination process amounts to 1.98 per cent, and the cost of calcining 1 cwt. of lead to about 2s.

**Baker's Method of Calcining Lead.\***—According to this method, hard slag lead, whose calcination in reverberatory furnaces is both expensive and tedious, may be purified in a short time, by ladling it from the receptacle basin into a red hot iron pot, after skimming off and adding either potash or soda saltpetre, adding it in the proportion of 1 part saltpetre to 100 of lead, or of 2 parts of sulphate of potash to 900 of lead. It is then stirred at a temperature higher than the melting point of lead, and the dross formed is skimmed off till the lead has assumed the hues characteristic of pure lead. The resulting lead is then fit for rolling or any other technical application.

**Pontifex and Glassford's Method of Calcination.†**—According to this method, soft lead, or a lead rich in antimony, may be produced as follows:—

\* B. u. h. Ztg., 1861, p. 440; 1862, p. 40. Polyt. Centrbl., 1861, p. 827.

† Polyt. Centrbl., 1855, p. 618.

Hard lead containing from 3 to 15 per cent of antimony is melted in a reverberatory furnace whose hearth consists of a cast iron pan; the dross formed is skimmed off, and upon the surface of the metal a mixture of 3 parts of soda saltpetre, 4 of calcined soda, and 4 of burned lime, is uniformly spread out. Then the furnace doors are closed for some time, but occasionally opened to observe whether a brownish scoria appears on the surface of the lead, which is generally the case after 10 or 20 minutes; the doors are then re-closed, fresh fuel is added, and when the smoke has disappeared so that the fire burns brightly, the covering is removed and another portion of the mixture is added; this goes on until a sample of the lead shows ductility.

Nine or 10 tons of lead may be treated in 24 hours, consuming about 55 lbs. of the mixture; when the lead is poor in antimony the addition of saltpetre may be omitted.

The scum of the lead is reduced in a cupola furnace; the resulting lead rich in antimony is smelted in an iron pan and cooled to the point at which highly antimonial lead crystallises, when it is ladled out as in Pattinson's process. This lead is sold as hard lead, and the remaining liquid is again treated with the mixture.

The annual production of lead amounts—

In Great Britain, to about 67,000 tons.		
„ Spain	„	60,000 „
„ Prussia	„	20,000 „
„ Austria	„	6,200 „
„ Belgium	„	4,000 „
„ Saxony	„	3,000 „

## CHAPTER II.

## SILVER.

## PRINCIPAL ORES OF SILVER.

ACCORDING to Malaguti and Durocher,\* silver occurs frequently in nature, and the following are the ores to which the attention of the metallurgist will probably be directed:—

I.—ORES IN WHICH SILVER FORMS A CHIEF COMPONENT  
(REAL SILVER ORES).

**Native Silver**, Ag, sometimes containing as much as 3 per cent of antimony, arsenic, and iron; the native ore silver at Freiberg,† containing from 97·10 to 99·8 per cent of silver, is usually associated with other silver ores, sometimes also with grey copper ores. In California,‡ silver occurs in admixture with gold; at Lake Superior,|| it is found upon native copper; at Kongsberg,§ it contains about 90 per cent

\* MALAGUTI et DUROCHER, *ii. d. Vorkommen, etc., des Silbers, Quedlinburg and Leipzig*, 1851. *Neuer Schauplatz der Bergwerkskunde*, xii. 57. B. u. h. Ztg., 1842, p. 3. COTTA, *Gangstudien*, i. 437; ii. 115, 254, 491. v. DECHEN, *Statis. des nördl. and zollv. Deutschlands*, i. 750.

† *Jahrb. f. d. B. u. Hm.*, 1831, p. 223. LAMPADIUS, *Fortschr.*, 1839, p. 111. B. u. h. Ztg., 1858, p. 37. HAUSMANN, *norrdteutsche Beitrage*, Stück, i. p. 127.

‡ *Allg. B. u. h. Ztg.*, 1862, p. 405. LAUR, *de la production des métaux précieux en Californie*. Paris: 1862.

|| *Berggeist*, 1862, No. 93. *Allg. B. u. h. Ztg.*, 1863, p. 164.

§ B. u. h. Ztg., 1858, p. 102; 1862, p. 434.

of silver. One mass\* from that locality in the royal collection at Copenhagen weighs upwards of 5 cwts., and later two blocks have been obtained weighing respectively 238 and 436 pounds. Much of the silver of Peru has been found in a native condition; a mass discovered at Huantaya weighed 800 pounds. But all these are surpassed by an immense mass discovered in Sonora, which, Wilson states, weighed 2,700 pounds, and was the subject of a suit brought on behalf of the King, who thought to recover it on the plea that it was a curiosity, and belonged to the Crown.

**Amalgam**, of different composition,  $\text{Ag}_3\text{Hg}_4$  containing 44·8,  $\text{AgHg}$  containing 51·9, and  $\text{Ag}_3\text{Hg}_3$  containing 57·2 per cent of silver, occurs frequently in Chili.†

**Antimonial Silver**,  $\text{Ag}_6\text{Sb}$ , and  $\text{Ag}_4\text{Sb}$  containing respectively 84 and 77 per cent of silver, occurs at Andreasberg also in Dauphiné, and near Coquimbo, South America.

**Mixed Antimonial Silver**. Its constituents are, silver 16, iron 44, arsenic 35, antimony 4; it occurs at Andreasberg in the Hartz.

**Telluric Silver**,  $\text{Ag Te}$ , containing 61 per cent of silver, sometimes also gold and traces of iron; it occurs in Siberia in a talcose rock with pyrites and blende; specimens have been obtained a cubic foot in size.

**Silver Glance**,  $\text{AgS}$ , containing 87 per cent of silver; it is frequently met with in the mines of the Hartz, Saxony, Bohemia, Mexico, and is also found in Cornwall and in the United States.

**Bismuth Silver** (*Sprödglasserz*, *Melangelce*),  $5\text{AgS}$ ,  $\text{SbS}_3$ , containing 68·5 per cent of silver, and sometimes small amounts of Fe, Cu, and As.

**Miargyrite**,  $\text{AgS}$ ,  $\text{SbS}_3$ , containing 36·9 per cent of silver.

**Light Red Silver Ore**,  $3\text{AgS} + \text{AsS}_3$ , containing 65·4 per cent of silver; sometimes part of the  $\text{AsS}_3$  is replaced by  $\text{SbS}_3$ ; it is found in Saxony and in Bohemia, also at Guadalcanal, in Spain.

\* LAMBORN, a Rudimentary Treatise on the Metallurgy of Silver and Lead. London: 1861.

† Allg. B. u. h. Ztg., 1863, p. 121.

**Dark Red Silver Ore**,  $3\text{AgS} + \text{SbS}_3$ , containing 59 per cent of silver; part of the  $\text{SbS}_3$  is sometimes replaced by  $\text{AsS}_3$ . Mixtures of both occurring at Freiberg, contained from 60·75 to 62·50 per cent of silver.

**Dark White Silver Ore**,  $4(\text{Cu}_2\text{S}, \text{FeS}, \text{ZnS}, \text{AgS}) + \text{SbS}_3$ , with 18 to 31·8 per cent of silver and 15 to 26 per cent of copper.

**Light White Silver Ore**,  $4(\text{FeS}, \text{ZnS}, \text{PbS}, \text{AgS}) + \text{SbS}_3$ , occurring at Freiberg with 38 per cent of lead, 5·7 per cent of silver, and traces of copper.

**Silver Copper Glance**,  $\text{Cu}_2\text{S} + \text{AgS}$ , containing 53 per cent of silver and 31 per cent of copper.

**Chloride of Silver**,  $\text{AgCl}$ , containing 75·2 per cent of silver.

**Megabromite**, an isomorphous mixture of chloride and bromide of silver,  $4\text{AgCl} + 5\text{AgBr}$ , containing 64·2 per cent of silver.

**Microbromite**,  $\text{AgBr} + 3\text{AgCl}$ , containing 69·8 per cent of silver.

**Embolite**,  $2\text{AgBr} + 3\text{AgCl}$ , containing 66·9 per cent of silver.

**Bromite**, **Bromargyrite**, bromide of silver,  $\text{AgBr}$ , containing 58 per cent of silver.

**Iodide of Silver**,  $\text{AgI}$ , containing 46 per cent of silver.

Silver in combination with chlorine, bromine, and iodine forms a class of ores which was once considered rare, but has since been found to constitute a valuable portion of many veins. They are generally found disseminated in a different part of the deposit from that in which the sulphides are found, and are associated with clay, quartz, calc spar, and baryta.

At Huëlgoet, in Brittany, they constitute the ore known as *terres rouges*; they contain an average of 0·05 per cent of silver, and are subjected to amalgamation. In Spain, the chloride appears to have existed in considerable quantities at the mines of Guadalcanal. Large quantities of this class of ores are worked in Chili, Peru, and Mexico; the veins in which they are found usually contain in their lower portions sulphides, arsenides, and compounds of antimony; they are also found in the mines of Norway, Saxony,

Siberia, the Hartz, and Cornwall. Iodide of silver occurs in various parts of the New World\* ; at Abarradon, in Zacatecas, it is found in thin veins in steatite. Bromide of silver is so abundant in the district of Plateros, Mexico, near Zacatecas, that the ores have received the name of *plata verde*, from the colour it causes them to assume.

**2. ORES CONTAINING SILVER IN A VARIABLE PROPORTION, AND NOT AS AN ESSENTIAL CONSTITUENT.**

Sulphuretted ores are always richer in silver than oxidised ores; the ferruginous sulphides are usually the poorest, and next come the sulphides containing zinc, lead, and copper.

Of these ores the following may be mentioned :—

**a. Argentiferous Lead Ores.**

Galena, PbS, containing between 0·01 and 0·03 per cent of silver, often, also, 0·5 per cent, but seldom as much as 1 per cent. According to Malaguti and Durocher, some of the galena of Rhenish Prussia contains upwards of 7 per cent of silver (Schemnitz). The ores of Joachimsthal, which average among the highest in Europe, generally contain about 2 or 3, and seldom exceed 10, per cent of silver. The average of the region about Clausthal is 0·098 per cent, and that of Andreasberg is 0·36 per cent. The Saxon galena averages between 0·025 and 0·809 per cent of silver.

White Lead Ores, containing traces up to 0·002 per cent of silver.

**b. Argentiferous Copper Ores.**

Fallow Ores† containing from traces up to 31 per cent of silver.

Copper Pyrites, Variegated Copper Ore, and Copper Glance, are generally poor in silver. Bournonite is somewhat richer.

Oxidised Copper Ores mostly contain mere traces of silver; sometimes they are richer, for instance, malachite ores at Bouc, in France, contain 0·525 oz. of silver and 0·0035 oz. of gold per cwt.

\* B. u. h. Ztg., 1859, p. 452; 1860, p. 187; 1861, p. 308.

† KARSTEN'S Archiv., 2 R., iv., 289. ERDMANN'S J. f. k., öu. techn. Ch., x. 219.

**c. Argentiferous Zinc Ores.**

Zinc Blende contains sometimes as much as 0·88 per cent of silver. Blende at Poullaouen contains 0·019; at Huëlgoet, 0·008; at Przibram, from 0·0027 to 0·0067; at Fahlun, 0·005; at Sala, 0·0033; and at Tunaberg, 0·001 per cent of silver. Blende in Hungary, Saxony, and Kongsberg contains mere traces. If zinc blende occurs with galena, sometimes the former, and sometimes the latter, will contain most silver; for instance, at Poullaouen the blende contains 0·004 and the galena 0·025; at Huëlgoet, the galena 0·125, and the blende from 0·002 to 0·004 per cent. The pure blende of Lautenthal contains 0·0008, and that of Freiberg 0·0006 per cent. Sometimes blende occurs richer in silver; for instance, the blende of Pontpéan\* (Bretagne), contains from 35·0 to 52·5 ozs. of silver per ton, from 5 to 8 times as much as the galena associated with blende contains. This blende is worked at Swansea.

Calamine from Altenberg contains 0·0001 per cent of silver.

**d. Argentiferous Iron Pyrites.**

They contain from traces up to 0·00150 per cent of silver, and are poorer than other sulphides if they happen to be associated with them.

**e. Argentiferous, Arsenical, and Antimonial Ores.**

Native Arsenic from Markirch (Upper Rhine) contains 0·00092, and that from Adreasberg (Hartz) 0·005 per cent of silver.

Mispickel sometimes contains 0·0038 per cent of silver.

Native Antimony from Andreasberg contains 1 per cent of silver, and that from Allemont 0·0004.

**Dressing the Silver Ores.**

Ores of the first class seldom occur in large quantities, and are mostly disseminated in the gangue (Dürr ores), requiring a most careful preparation; and it depends on local circumstances whether it is advantageous to concentrate the

\* Revue Univers., 1863, 2 livr., page 294. Bulletin de la Société de l'Industrie minérale, tom. viii., livr. 4. 1863.



amount of metal so as to cause loss of silver but saving of fuel in the smelting process, or to work a larger and poorer quantity with a larger consumption of fuel. Ores containing much baryta have lately been prepared by heating them with coal and washing out with water the sulphide of barium formed.\*

Ores of the second class are usually first sorted as perfectly as possible by hand, partly to facilitate the dressing of the ores and partly to prepare them for a suitable metallurgical process, as, in most cases, it is not possible to smelt the ores in the proportions in which they occur in nature. How far hand separation is to be carried on, as well as the farther dressing of the separated ores, depend on the requirements of the metallurgical process, which will in some cases aim at the production of the accompanying metals (lead, copper), or the extraction of silver from those metals (for instance, zinc, arsenic, antimony, bismuth). And as the value of the silver is in many cases much the highest, its extraction is effected at the expense of the copper which is present.

#### **SYNOPSIS OF PROCESSES FOR THE EXTRACTION OF SILVER FROM ITS ORES.**

The great variety of ores in which silver occurs usually makes it necessary to employ complicated processes for its extraction.†

##### **A. EXTRACTION OF SILVER, IN THE DRY WAY, BY MEANS OF LEAD.**

By fusing argentiferous substances with metallic lead, or by smelting such substances together with lead, lead products or lead ores (when the silver ore does not already contain a sufficient amount of lead), an argentiferous raw lead is produced; this lead is either cupelled or, if containing but little silver, is previously treated by Pattinson's process. The silver resulting from the cupellation process is refined by another process, which produces fine silver. It depends on

\* Oesterr. Ztsch., 1862, No. 464; 1863, No. 1. B. u. h. Ztg., 1863, p. 114, 269.

† KARSTEN'S Archiv. 2 R., xxv.; 174. B. u. h. Ztg., 1852, p. 73, 815.

the amount of silver present, on the price of materials, &c., whether it is advisable to desilverise the ores at once or the intermediate products (matt, raw copper, &c.)

These processes are very old, and applicable to argentiferous substances of every kind; but they are mostly imperfect on account of their complications, producing more or less intermediate argentiferous products, whose farther treatment requires much time and a great consumption of fuel, and causes a great loss of metal.

Many of these processes have, therefore, lately been replaced by more perfect processes in the wet way. The choice of a process is chiefly influenced by the nature of the ores and local circumstances, such as whether lead ores are cheap or totally absent. Lead, for instance, is most valuable for treating auriferous silver ores and products, as it extracts silver and gold at the same time, which can only be very imperfectly effected by other means. Only lately, Patera and Roessner have discovered how to extract gold and silver in the wet way, by means of a solution of chloride of soda saturated with chlorine.

The following ores are submitted to treatment with lead:—

1. **Argentiferous Galena**, from which the greater part of our silver is obtained. The processes adopted are described in Chapter I. (Lead). They are the oldest,\* and generally the simplest, for which the amalgamation process may be advantageously substituted in rare cases only, as, for instance, if fuel is not easily procurable, as in Nicaragua.† The less copper the ores contain the more easily and perfectly the silver may be extracted.

2. **Silver Dürr Ores**, mixtures of real silver ores with earthy, sulphuretted substances, &c. (Dürr ores containing earths, pyrites, blende, copper).

Rich earthy Dürr ores, if they contain chiefly native silver, are sometimes smelted together with lead products in crucibles (formerly at Kongsberg), or they are refined at once with an addition of litharge (now at Kongsberg); and if they consist of other ores, with from 50 to 90 per cent of silver, it is

\* Bgwkfd., xii., 590.

† B. u. h. Ztg., 1862, p. 268.

judicious to add them to the raw lead during cupellation (Andreasberg). Moderately rich earthy Dürr ores may be smelted with lead ores or products (Andreasberg, Freiberg). For such ores also Patera's process in the wet way is advantageously applied, as at Joachimsthal, for ores containing from 0.4 lb. up to the highest amount per cwt.

**Poor Earthy Dürr Ores** containing 0.12 to 0.25 oz. of silver per cwt. are first smelted with iron pyrites for producing raw matt, in which the silver becomes concentrated, and the matt is then desilverised by being fused with metallic lead, or by being smelted with substances containing lead. This is the more completely effected the less copper the matt contains. Ziervogel's mode of extraction is also sometimes employed for these matts (Schemnitz); also the amalgamation process, which latter is likewise used direct for somewhat richer Dürr ores, containing from 2 to 8 ozs. of silver with a little iron pyrites (Arany-Idka, formerly in Freiberg).

**Pyritic Dürr Ores.**—Silver ores disseminated in iron pyrites are roasted and mixed with lead if they contain a larger amount of silver, but if they are poor in silver they are either mixed with poor earthy Dürr ores in the raw smelting process, or are submitted to a raw smelting after having been more or less roasted, and the resulting matt is melted with lead. Such ores containing a moderate amount of silver are best adapted for the amalgamation process (Arany-Idka) if they are not associated in larger quantities with deleterious substances, such as arsenical and antimonial compounds, zinc blende, galena, &c.

**3. Argentiferous Copper Ores.**—The process to be followed for the extraction of the silver from these ores depends on the amount of silver and copper present.

*a.* Copper ores rich in silver are smelted, either in a roasted or unroasted state, with roasted or raw galena, lead products, &c., for the production of raw lead and copper matt; the copper matt, either roasted or raw, is desilverised by repeated fusion with lead (Müsen, Freiberg, Andreasberg).

*b.* Ores poorer in silver are treated for the production of a

matt, and if the matt is sufficiently argentiferous, it is repeatedly smelted with lead; if not, the amount of silver is further concentrated in raw copper, which is then desilverised by the liquation process.

These processes are advantageously replaced by processes in the wet way; for instance, the amalgamation of matt (formerly in Mansfeld), and of raw copper (formerly in Tajowa, Schmöllnitz, Banat); Augustin's process with matt (Hungary); Ziervogel's process with matt (Mansfeld); and chiefly when treating lead copper matt, the extraction of the concentrated roasted matts with diluted sulphuric acid (Freiberg); or the extraction of raw copper (Oker smelting works on the Hartz, Altenau, Fahlun).

According to Karsten, silver can only be extracted advantageously from poor cupriferous and argentiferous ores which contain 0.031 per cent of silver, if other circumstances, such as the mining cost of the ore, the association of these poor ores with richer ores, &c., are favourable. But if at the same time they contain so much copper or lead as to make the extraction of these metals profitable, it will pay to extract the silver even though it should be less than from 0.16 to 0.1 oz. per cwt.

**4. Argentiferous Zinc Blende and Arsenical Pyrites** are seldom metallurgically treated, but when they are, they should be first roasted, then submitted to a raw smelting, and afterwards to fusion with lead. The roasting process may occasion considerable loss of silver, especially the roasting of zinc blende. Experiments for extracting silver from blende in the wet way have yielded better results in England than in Przibram.\*

**5. Argentiferous Native Arsenic** is carefully roasted to drive off the arsenic as arsenious acid, and then fused with lead (Andreasberg).

**6. Argentiferous Nickel and Cobalt Ores** are either directly fused with lead (experiments at Freiberg),† or they

\* NEUMANN'S *Extraction*, 1863, p. 107. B. u. h. *Ztg.*, 1860, p. 104. *Leobener Jahrbuch*, 1857, vii., 236.

† *Freiberger Jahrbuch*, 1848, p. 79.

are previously smelted for the production of speiss, which is then advantageously submitted to the amalgamation process. If they are rich in silver they are sometimes treated by Patera's process in the wet way, thus allowing nickel and cobalt to be extracted as well as the silver (Joachimsthal).

#### B. EXTRACTION OF SILVER IN THE WET WAY.

These processes generally effect a quicker and more perfect extraction, and allow a saving of materials, chiefly fuel; but they require ores and products of a certain nature, and this limits their utility to a great extent.

1. **The Amalgamation Process.**—The extraction of the silver by mercury, and the subsequent volatilisation of the mercury by heat. This process was invented in Mexico about the middle of the 16th century, but it was only introduced into Europe in the second part of the 17th century, and into Hungary about 1780 by Born, and in Freiberg by Gellert. This process has advantages over the mode of extraction by means of lead. If the price of fuel is high and that of mercury low, Dürr ores poor in silver, or copper ores free from lead, and similar cupriferous intermediate products are used (copper matt, raw copper). When using poor earthy ores, silver may be concentrated by a previous smelting with iron pyrites; only the real silver ores can be directly submitted to the amalgamation process. The silver contained in argentiferous copper ores is best concentrated in copper matt or raw copper, and then these products are amalgamated. The amalgamation of the copper ores is cheaper, and it also enables a more perfect extraction of silver to be effected, causes less loss of copper, and gives a purer copper than the process with lead. On the other hand, the fine copper always retains  $\frac{1}{4}$  oz. of silver per cwt., and if the ores are auriferous, a considerable loss of gold takes place; therefore auriferous raw copper is unfit for the amalgamation process. The advantages of the European amalgamation process over the American consist in a more perfect extraction of the silver, and a considerably less loss of mercury. On the other hand, the American process requires no special buildings, machines, or fuel.

**2. Mr. Crookes's Process of Extraction by means of Sodium Amalgam.**

**3. Lixiviation and Precipitation of Silver in the Metallic State.**

This mode of treating argentiferous ores and products was introduced almost at the same time by two of the officers of the Mansfeld Mining Company, Augustin and Ziervogel, in 1849. They surpass the system of liquation and amalgamation in simplicity and cheapness, in the rapidity and completeness with which the metal may be obtained from the mineral, and also in being healthier for the workmen engaged upon them. They are far more economical than fusion with lead, in fuel, in the time required, and in the amount of the various metals lost; while they are superior to the process of liquation in requiring less time and fuel, in accomplishing a more complete separation of the copper and silver, and in allowing the production of a copper of excellent quality.

Augustin converts the silver contained in ores or products into chloride of silver by roasting in connection with common salt (chloride of sodium). He dissolves the chloride of sodium in a concentrated hot solution of common salt, and precipitates the silver in a metallic form by the addition of metallic copper. Ziervogel roasts the ores, &c., with proper precautions, in order to convert the silver in the ore into sulphate of silver; this is lixiviated with hot water and precipitated by copper.

Both these methods are only successful when the preliminary roasting process is carried on with the greatest care, requiring very skilful and intelligent workmen, and when the ore or product under treatment is not too rich, and is either free, or nearly free, from noxious substances (lead, zinc, antimony, arsenic). Ziervogel's process is cheaper and simpler than Augustin's process, but it requires a purer raw material.

**4. Patera's Process** is chiefly adapted for mixtures of rich silver ores with nickel and cobalt ores. The ores are first roasted in the presence of steam, and afterwards with common salt; the chloride of silver formed is dissolved by a

solution of hyposulphite of soda ( $\text{NaO}$ ,  $\text{S}_2\text{O}_2$ ), and precipitated as a sulphide by polysulphide of sodium; the remaining solution is used for the extraction of nickel and cobalt.

**5. Treatment of purified Raw Copper, or Roasted Concentrated Copper Matt, with Dilute Sulphuric Acid.**—The separation of silver and copper by sulphuric acid was formerly recommended by Serbat\* and Karsten, but it has only recently been practically applied. Sulphate of copper and argentiferous residues result from the process, and they are treated with lead. In contrast to the former processes, this method admits of the application of lead products, and has recently replaced the liquation process in several places. The process at the same time extracts a greater amount of gold than the liquation or amalgamation processes. Wehrle and Rochel† have recommended roasting the refined and granulated copper in a reverberatory furnace with common salt, and that the resulting oxide should be dissolved out with dilute sulphuric acid; but this process is less simple.

The chief modes at present adopted of extracting silver from its ores and from argentiferous products may be classed under the following divisions:—

#### A. TREATMENT OF ARGENTIFEROUS ORES AND PRODUCTS IN THE DRY WAY BY MEANS OF LEAD.

This treatment aims at the production of argentiferous raw lead, from which the silver is extracted by subsequent processes; it may, therefore, be subdivided into—

**1. Production of Argentiferous Lead.**—The processes vary according to the ores and products to be treated. Thus, rich silver ores are differently treated from Dürr ores poor in silver. The treatment of argentiferous lead and copper ores is described in the chapters Lead and Copper. Argentiferous products, such as matt, speiss, and black copper, are either treated with lead or with plumbiferous products.

\* *Annalen der Chemie und Physik*, Bd. 31, p. 436.

† *Oesterr. Zeitschr.*, 1857, p. 281, 289, 313.

**2. Extraction of Silver from the Raw Lead.**—This is effected either by Pattinson's process or by the cupellation process, which may be performed in two different modes, namely, by the *German process* and by the *English process*. The resulting brightened silver is then refined by separate processes, either in cupelling furnaces, in muffle furnaces, in reverberatory furnaces, or in crucibles.

The extraction of silver by means of zinc has also been proposed.

#### B. TREATMENT OF ARGENTIFEROUS ORES AND PRODUCTS IN THE WET WAY.

This treatment is also performed in different ways ; it may, therefore, be subdivided into—

**1. Extraction of Silver by Amalgamation.**—Experience has developed different modifications of this process, namely, the European process of amalgamation in casks, the American amalgamation process, also a combined amalgamation, and Mr. Crookes's process of extracting silver by sodium amalgam.

**2. Extraction of Silver by Lixiviation and Precipitation.**—Three different processes are chiefly employed, namely, Augustin's process, Ziervogel's process, and Patera's process. This mode of extraction is applicable to ores and products.

**3. Copper Matt and some Raw Copper** are also treated for the extraction of their silver by lixiviation with sulphuric acid, and by fusing the argentiferous residues with lead.

#### A. TREATMENT OF ARGENTIFEROUS ORES AND PRODUCTS IN THE DRY WAY BY MEANS OF LEAD.

The lead is employed either in the metallic, oxidised, or sulphuretted state, and in the latter case it becomes reduced to metallic lead in the smelting process by the action of iron or some other substance. The decomposing action of the lead and its compounds upon argentiferous substances is variable.



**1. Decomposition of Sulphide of Silver by Metallic Lead, forming Sulphide of Lead and Metallic Silver which enters into combination with the excess of Lead.**

[www.libtool.com.cn](http://www.libtool.com.cn)

The following reaction takes place:—

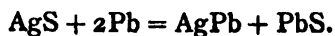

If the silver ores contain other sulphides, such as  $\text{Cu}_2\text{S}$  and  $\text{FeS}$ , they will also become more or less decomposed by the reaction of lead, and their bases will injure the purity of the raw lead.\*

The products of the smelting process are argentiferous lead and desilverised matt ( $\text{FeS}$ ,  $\text{Cu}_2\text{S}$ ,  $\text{PbS}$ ). The less copper the ores contain, the easier and the more perfect will be the extraction of the silver, as the  $\text{Cu}_2\text{S}$  of the matt persistently retains part of the  $\text{AgS}$ , and makes a repetition of the process necessary; but as silver ores are seldom free from argentiferous copper ores, a cupriferous matt always results, which cannot be completely desilverised by lead or lead ores. The residual silver is either considered as lost, or it is extracted from the raw copper produced from the matt. Sulphides of lead and iron also retain small amounts of silver. Lead acts upon antimonial and arsenical silver as it does upon sulphide of silver.

This chemical reaction takes place,—when smelting rich sulphuretted silver ores with lead ore in crucibles; when fusing them with lead; when treating raw argentiferous matt with metallic lead; and partly in the precipitation process of reducing argentiferous galena with iron. In this last process part of the silver becomes extracted by the iron decomposing  $\text{AgS}$ ; a long continued smelting would decompose it further, but still it would never get perfectly decomposed.

When the ores contain native silver, the silver immediately combines with the lead.

The desilverising of matts by lead is facilitated by an addition of copper, which extracts the silver from the sulphide, forming sulphide of copper.

\* ERDMANN'S Journ., x., 13.

## 2. Decomposition of Oxide and Sulphate of Silver by means of Metallic Lead.

The following reactions take place;—



*a.* When smelting roasted silver ores with lead or lead products from which metallic lead can be reduced; as AgS, when roasted with other metallic sulphide becomes more or less converted into AgO, SO<sub>3</sub>.\*

*b.* When cupelling raw lead, PbO and AgO † are formed, the AgO again is partly decomposed by contact with the excess of lead.

*c.* Scorified suboxide of silver becomes reduced from the slags by means of lead, or becomes sulphuretted by sulphide of lead. According to Rose and Lenssen, † Ag<sub>2</sub>O forms, with bases of the type R<sub>2</sub>O<sub>3</sub>, combinations able to resist higher temperatures without decomposition or a higher oxidation of the Ag<sub>2</sub>O.

## 3. Decomposition of Sulphide of Silver by Oxide or Sulphate of Lead.

In this case the following reactions take place;—

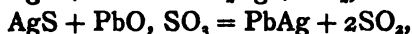
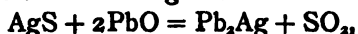

*a.* When smelting raw silver ores or argentiferous matt together with roasted lead ores or oxidised lead compounds (litharge, &c.); at the same time the reactions stated under the headings 1 and 2 may also take place by the reduction of metallic lead; hearth ends are a better reagent for desilverising than litharge, which is too quickly reduced, preventing the lead from coming into intimate contact with the silver; the hearth is therefore preserved for the last desilverising of the matt (Müsen).||

A formation of matt and a retention of silver by the matt are therefore unavoidable in this process.

\* KARSTEN'S Metallurgie, v., 472.

† FOURNET in Erdmann's J. f. ök. u. techn. Ch., i., 49, 80.

‡ ERDMANN'S J. f. pr. Ch., Bd. 85, p. 96.

|| Preuss. Ztschr., x., 199.

b. When treating argentiferous galena in a reverberatory furnace. Here proportionately more  $\text{AgS}$  than  $\text{PbS}$  becomes decomposed by the oxide and sulphate of lead which had been formed by roasting; and according to Fallize,\* the lead reduced at the beginning of the process is richer in silver than the lead afterwards obtained.

c. When fusing rich silver ores with raw lead and during cupellation, the sulphide of silver becoming decomposed by lead and oxide of lead.

d. When refining rich silver ores containing native silver and sulphide of silver, with an addition of lead (Kongsberg).

#### 4. Extraction of Silver from Argentiferous Copper by means of Lead.

This is effected by fusing both together, by liquation of the argentiferous lead, and by cupelling the copper with lead.

#### PRODUCTION OF ARGENTIFEROUS LEAD (RAW LEAD).

##### 1. Lead process with Argentiferous Ores.

The ores named on page 9 may be submitted to this process either raw or in a roasted state; and metallic lead, raw or roasted lead ores, or lead products, are used in the operation.

##### Treatment of Rich Silver Ores.

These ores (native silver, ruby silver ore, chloride of silver, &c.) are best and cheapest worked by fusion with lead and cupelling. Ores chiefly containing native silver may be advantageously smelted in crucibles, or refined without any preliminary process. Ores of moderate richness, which cannot be treated with success by those methods, are smelted with iron and lead ores, or similar products.

**Smelting of Rich Ores in Crucibles.**—This smelting is conducted either in plumbago or in fire clay crucibles, usually with an addition of iron for decomposing the  $\text{AgS}$ , and some lead, if none is contained in the ores. Litharge is preferable

\* B. u. h. Ztg., 1860, p. 359; 1863, p. 285.

to lead when earthy substances are present, and then it is also advisable to make an addition of carbonate of potash and glass. The resulting plumbiferous silver is refined, and the matt usually desilverised by a second treatment with iron.

**Former Mode of Smelting Rich Ores at Kongsberg.\*—**The ore veins of Kongsberg† contain chiefly native silver, and frequently other rich silver ores, such as silver glance, &c., in association with galena, copper pyrites, and zinc blende. Native silver containing 90 per cent of silver, and some schlich, result from dressing these ores; the schlich is submitted to a raw smelting and to a fusion process.

The native silver was formerly smelted on a small refinery hearth urged by a blast; but as the volatilisation of arsenic, zinc, and sulphur caused too much loss of silver, it was then smelted in crucibles, which caused less loss; but the loss was greater again in the subsequent refining process. An addition of 3 per cent of iron filings for decomposing the volatile sulphide of silver, lessened that loss considerably, particularly when less copper was contained in the ores. An addition of quartz and 1 per cent of borax was made to scorify the FeO. The smelting was done in quantities of 300 lbs. in an air furnace, and one crucible was used from 4 to 6 times. The following products were obtained:—

*a.* **Silver**, which was refined with a little addition of lead (1 oz. to 3 lbs.), and the loss of silver amounted to  $2\frac{1}{4}$  ozs. per lb.

*b.* **Slags**; these were pounded together with the dross of the refining process, washed to collect the larger silver grains, and then used in admixture in the raw smelting process. The following simpler method has been adopted since 1844:—

**Refining the Native Silver.**—The native silver with some little silver glance is quickly melted on the refinery

\* HAUSMANN *scandinavische Reise*, ii., 33. RUSSEGGER'S *Reisen*, iv., 551. B. u. h. Ztg., 1855, p. 49, 99; 1858, p. 101. BOBERT, in KARSTEN'S *Archiv.*, xii. Leobener Jahrbuch, 1852, ii., 190. COTTA, *Erzlagerstätten*, 1861, ii., 512.

† TUNNER'S *Leobener Jahrbuch*, 1852, ii., 191. B. u. h. Ztg., 1855, p. 99; 1856, p. 164; 1862, p. 433.

hearth\* with an addition of some cut-up iron wire, lime, and 1.5 per cent of litharge, the working door being kept closed. The dross is then skimmed off, and the silver refined as usual. Dross and hearth are worked in a small cupola furnace for the production of an alloy containing 8 or 10 ozs. of silver per lb., and this is added to the next refining smelting; the matt resulting at the same time (3 to 6 cwts. per annum), and which contains from 4 to 6 lbs. of silver per cwt., is fused with lead, and the slag worked in the raw process.

**Fusing Rich Silver Ores with Raw Lead in the Cupelling Process.**—In this process the sulphuretted and arsenical silver is chiefly decomposed by the litharge formed at the cupellation, which also combines with the earthy substances of the ore forming a slag, whilst the liberated silver enters into combination with the lead.

At Andreasberg,† in the Hartz, silver ores with 10 per cent of silver are distributed in quantities of 1 or 2 cwts. over the surface of the poor raw lead on the hearth of the cupelling furnace, just when the formation of litharge begins, and the blast being turned off a strong fire is given for about one hour. The silver is reduced partly by the roasting and partly by the reaction of the oxide of lead, and enters into combination with the lead; the whole mass becomes very fluid, and by the influence of the blast the earthy substances form a slag which is skimmed off, and if it contains some ounces of silver, is added to other lead smelting processes.

At Poullaouen‡ the red earths of Huëlgoet (quartz sand and ferruginous clay, with native chloride, bromide, and sulphide of silver), containing more than two per cent of silver, and raw silver of the amalgamation process, are added during cupellation; the former at the period when commercial litharge is formed, which quickly decomposes chloride of silver, &c., and the latter towards the end of the cupelling process, as the marketable litharge would otherwise become too argentiferous.

\* B. u. h. Ztg., 1855, p. 117; 1862, p. 437.

† K&ERL, Oberharzer Hüttenpr., 1860, p. 694.

‡ Rivor, Traité de Metallurgie, ii., 617, 1860. B. u. h. Ztg., 1859, p. 351.

At Freiberg, also, native silver and rich silver ores are reduced during the cupelling process.

### Smelting Rich and moderately Rich Silver Ores with Lead Compounds.

This method can only be carried out with advantage as regards the yield of silver; when it is possible to add enough lead ores and products to protect the silver, otherwise a greater loss of silver would take place by scorification, and more silver would remain in the intermediate products. According to experiments made at Andreasberg, from 2 to 3 lbs. of lead are required for every 0.01 lb. of silver; according to experiments made by Markus\* at Joachimsthal, the following conditions are very favourable to desilverising without loss of metal:—A high furnace, wide in the lower part; inclined tuyeres of 20°; dark nose 9 or 10 inches long; non-flaming furnace mouth; a quick process with a pressure of the blast of four lines of mercury; and a slag of the composition,—

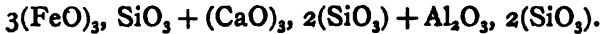

If lead products and ores are not to be had, it is best to treat silver ores, when not too rich, by a raw process previous to desilverising by lead, collecting the silver into a matt by means of iron pyrites.

### Illustrations of the Processes of Smelting Rich Silver Ores.

At Andreasberg, silver ores with from 2½ to 10 per cent of silver are smelted together with galena, the products of the cupelling process, iron, and slags; this process produces rich lead: the richer ores are fused with lead, and the poorer ores are worked by the process for producing poor lead. At the rich lead smelting it is arranged that from 2 to 3, and at the poor lead smelting from 4 to 5 lbs. of lead shall be present for every 0.01 lb. of silver. The resulting raw lead is cupelled, the lead matt repeatedly worked over, and the copper matt last resulting from these processes is trans-

\* B. u. h. Ztg., 1857, p. 51.

formed into raw copper, which is then desilverised by a liquation process.

At the smelting works in Lower Hungary, the Dürre ores, and those containing the highest amount of silver, are worked together with roasted lead ores and raw matt; and at the works in Upper Hungary, poorer ores are smelted in the poor lead smelting, and rich ores in the rich smelting process.

At Allemont,\* in the department of Isère, the silver ores, consisting of native silver, silver glance, and red silver ore, and associated with calc spar, siliceous clay, a little iron pyrites, and a large amount of brown iron ore, are sorted by hand and stamped without water. Five tons of ore, with an average of 0·7 lb. of silver per cwt., are mixed with 7 tons, 10 cwts. of ore slags, 16 cwts. of burned lime, 16 cwts. of iron refinery cinders, and so much galena, litharge, and hearth that the raw lead will contain 2 lbs. of silver per cwt. The smelting process is carried on in low cupola furnaces 3½ feet high, and gives the following products:—

*a. Raw Lead*; this is cupelled, and contains only about  $\frac{2}{3}$  of the silver present in the ore.

*b. Matt*, which contains  $\frac{1}{3}$  of the silver of the ore; this is smelted with litharge and hearth, and produces a raw lead which is cupelled again, and a second matt which is thrown aside.

*c. Slags*; only part is used again as a flux in the mixture.

This process has all the faults which were before pointed out; the galena is found at a great distance from the smelting works, its application is therefore limited as much as possible, and this causes great loss of silver by scorification. The large amount of silver in the matt indicates an unsuitable mixture, and the low furnaces only permit an ineffectual reduction and consume a considerable amount of fuel.

In Freiberg,\* raw and rich Dürre ores are smelted during the lead smelting process.

‡ Freiburger Jahrbuch, 1848, p. 79.

\* KARSTEN'S Metallurgie, v., 508.

### **Treatment of Argentiferous Lead Ores.**

We may here refer to most of the processes treated in the chapter on Lead. Lead ores are seldom wholly without silver, therefore the method described in that chapter may be considered as preliminary processes for the extraction of silver. The introduction of Pattinson's process has facilitated the extraction of small amounts of silver in many smelting works where it was formerly considered impracticable; the tapping off of the lead resulting from the first reaction period in reverberatory furnaces, has also allowed the extraction of the silver contained in it.

### **Treatment of Argentiferous Copper Ores.**

This method consists in smelting the roasted copper ores with roasted lead ores, and repeatedly desilverising the resulting lead and the subsequent copper matt with lead products, and finally liquating the raw copper. It requires much time and fuel, and many expensive intermediate processes, which impede a clear survey and cause the formation of impure products. It is chiefly used where the silver, lead, and copper ores are so intermixed that a separation is either impossible, or only to be obtained with great expense and loss.

### **Illustrations of the Processes for the Reduction of Argentiferous Copper Ores.**

The smelting process at Lohe\* and Müsen has been already described under Lead, but the process at Lohe has been somewhat modified of late. The roasting of the lead ores now takes place in a reverberatory furnace, and requires barely 1-20th of the time formerly required. The nuisance of the roasting gases is abolished; the processes of working the matt are considerably simplified in consequence of the better and more uniform roasting, and a saving of fuel is effected.

At Freiberg, copper ores, when not containing upwards of 6 per cent of copper, and more than 0.12 lb. of silver per cwt., are roasted and smelted together with lead ores.

\* Preuss. Zeitschr., 1862, x., p. 172. B. u. h. Ztg., 1863, p. 91.



### Raw Smelting of Poor Dürr Ores, nearly or quite free from Lead and Copper.

If fused direct with lead, these ores would, on account of their excess of earths, cause a great loss of metal by scorification, and produce a lead poor in silver, &c. ; so that it is advisable previously to melt them together with iron pyrites (if they do not already contain it) in order to produce a raw matt chiefly consisting of sulphide of iron ; in this the silver is sufficiently concentrated by suitable fluxes (scorifying the earths and foreign metallic oxides), that it may be extracted from the raw or roasted matt by means of lead, if other circumstances do not make the wet way preferable. Where iron pyrites is not obtainable, baryta\* is used for the formation of matt (Siberia). The roasted raw matt reacts most favourably in the fusion process with lead (in contrast to an ore with the same amount of silver) ; the iron present protects the lead from scorification, it assists the formation of slags, and precipitates lead from the sulphide of lead present. These advantages fully compensate for the cost of its formation.

Another advantage of this raw process is that all the resulting by-products (slags, &c.,) may be taken in admixture, so as to allow the extraction of a great part of the copper, silver, and lead contained in them.

The following are the chief points to be considered in carrying out the raw smelting process :—

1. **The Formation of a suitable Mixture.**—With regard to the amount of silver in the raw matt, experience shows that the concentration of the silver in raw matt must be confined to certain limits (between 0·16 and 0·2 per cent of silver), otherwise the loss of silver will be too great, as particles of raw matt are always mechanically retained in the slags ; the richer the raw matt is therefore, the greater will be the loss of silver in the slags, which also frequently renders a concentration of raw matts disadvantageous ; ores containing antimony and arsenic cause great loss of silver by volatilisation.

In order to form a proper mixture, the amount of silver in

\* Bgwkfd., xvi., No. 7.

the ores and fluxes must be determined by an assay, and the quantity of raw matt which may be produced by the iron pyrites, &c., must also be ascertained by a raw matt assay.

This assay\* is performed as follows:—

One assay part of ore is put at the bottom of a clay crucible, upon it 2 or 3 parts of vitreous borax, upon these 1 or 2 parts of glass free from lead; this is covered with  $1\frac{1}{2}$  or 2 parts of common salt; a piece of charcoal is put on the top, and the crucible is heated for  $\frac{1}{2}$  or  $\frac{3}{4}$  of an hour in an air furnace. In case metallic oxides or sulphates are present, from 0·04 to 0·1 part of coal dust or rosin is added to the ore, and when the ores are very refractory, some lime and fluor spar are added.

The slag, which is usually vitreous and of a green colour, owing to the presence of some metallic oxides, must have been perfectly liquid and easily separated from the brittle regulus; when the latter has been weighed, it is broken, and an idea is formed from its appearance as to whether it contains certain ingredients which may be injurious in the raw smelting process. A regulus, consisting almost entirely of pure sulphide of iron, has a yellow colour, and soon becomes dim and crumbles, in consequence of the presence of a little sulphide of sodium which becomes decomposed into NaO, SO<sub>3</sub> and HS. A matt of a more steel-grey colour, of semi-metallic lustre, laminated or radiated, not crumbling at all, or crumbling but little in the air, indicates zinc blende; the amount of zinc blende is very high when the slag is intermixed with blende and the resulting regulus is too small and angular, or when none at all is separated. Efforts have been made to counteract the noxious influence of too great an amount of zinc blende by a large addition of borax and by employing high temperatures, also by facilitating the collection of the matt by an addition of from 0·005 to 0·01 part of metallic copper in the form of wire or filings to roasted ores, and of 0·02 parts to raw ores. Sulphide of lead gives the matt a whitish-grey colour and a laminated fracture.

\* B. u. h. Ztg., 1859, p. 147. Oesterr. Ztschr., 1856, p. 41, 145, 281. BODEMANN KERL's Probirkunst, 1857, p. 502.

When roasted ores are used, and an extraction of lead has taken place, the regulus must be weighed, pounded, the lead separated and its weight subtracted, as well as the weight of the copper which may have been added. Copper pyrites gives rise to a brassy yellow colour and a quick deadening of the fragments; subsulphide of copper causes a bluish grey colour, a fine grain, and great brittleness. Arsenic and sulphides when together, and when the sulphides prevail, cause the formation of a speiss-like matt; when the reverse is the case, speiss and matt are separated.

These admixtures modify considerably the value of the pyrites, when the latter is used as a reagent for the extraction of silver, and they sometimes make it necessary to determine the different substances contained in them by wet analysis.\*

The amount of raw matt in the mixture must be kept between 30 and 50 per cent, and the mixture must be obtained either by a suitable mixing of the different ores, if they contain sufficient pyrites, or by an addition of pyrites. The pyrites is seldom quite pure; and it is desirable that it should contain an amount of silver. The presence of copper pyrites has a partially advantageous influence, as it enables the iron pyrites to collect the silver better, and as the resulting matt separates more easily from the slags on account of its greater cohesion; on the other hand, cupriferous raw matt is more difficult to desilverise by means of lead. Arsenical pyrites and zinc blende act injuriously if in larger quantities; they weaken the collecting power of the sulphide of iron; the former causes loss of silver by volatilisation, and the latter renders the mass difficult to fuse. A larger amount of zinc acts disadvantageously upon the subsequent processes. Occasionally, when pyrites is not easily obtainable, sulphate of baryta is substituted (Altai). The sulphide of barium which is formed enters partly into combination with the matt, rendering it specifically lighter and more difficult to separate from the slags, and retaining silver and gold in the subsequent fusion with lead. Aidarow,† therefore, smelts ores containing sulphate of baryta together with iron ore, for

\* HAUCH, in Oesterr. Ztschr., 1857, p. 135.

† Bergwerksfreund, xviii., 69.

the separation of baryta; and then he again smelts the resulting matt, having previously roasted it, together with new silver ores, which causes a decreased consumption of iron ore, and also the production of a raw matt containing double the amount of silver.

Endeavours have been made, with more or less success, in Siberia\* and in Tyrol, † to enrich poor silver ores containing sulphate of baryta by heating them with coal and by washing out the resulting sulphide of barium with water.

The mixture must be made with regard to the formation of slags. Experience shows that the slags which are best for the raw smelting are those containing protoxide of iron and lime approaching to a bi-silicate, as they most easily allow the raw matt to sink to the bottom, without themselves cooling too quickly. Higher silicated slags increase the consumption of fuel, and lower silicated slags require when working a quartzose smelting mass, more flux, and consequently an expenditure of more fuel and labour.

The raw slags at Freiberg, for instance, are combinations of mono- and bi-silicates of the formulæ,—

$3(\text{CaO}, \text{MgO}, \text{FeO}), 2\text{SiO}_3 + \text{Al}_2\text{O}_3, 2\text{SiO}_3$ , and,

$5(\text{CaO}, \text{FeO}), \text{SiO}_3 + 7(\text{CaO}, \text{MgO}, \text{FeO}), 3\text{SiO}_3 + \text{Al}_2\text{O}_3, \text{SiO}_3$ .

The following are analyses of such slags:—

	SiO <sub>3</sub> .	Al <sub>2</sub> O <sub>3</sub> .	FeO.	MnO.	CaO.	BaO.	MgO.	PbO.	Cu.	Zn.	SO <sub>3</sub> .	S.
1.	48·75	10·10	35·69	0·03	4·89	—	trace	—	—	—	—	—
2.	50·33	6·10	38·25	trace	3·38	trace	2·00	trace	—	—	—	—
3.	50·49	3·44	20·93	·42	7·85	—	2·88	3·20	trace	6·84	—	2·45
4.	53·72	4·67	16·94	2·41	7·94	—	3·04	2·00	1·31	5·10	—	2·74
5.	29·0	4·5	49·5	—	8·4	—	—	—	—	—	—	8·6
6.	52·1	trace	30·6	—	5·6	—	0·4	—	—	—	—	11·3

Nos. 1 and 2 are raw slags from Freiberg, 3 and 4 from Schemnitz, and 5 and 6 from Joachimsthal.

According to Samuelsen, a greater formation of iron deposits takes place in the raw smelting process when the mixture contains more pyrites. He states that when this is the case sulphide of carbon is abundantly developed, and this sulphide of carbon has a strong reducing action upon oxidised iron, forming Fe<sub>3</sub>S, which is then decomposed into

\* Oesterr. Zeitschr., 1862, No. 49, 50. B. u. h. Ztg., 1863, p. 114.

† Ibid, 1863, No. 1. Ibid., 1863, p. 269.

$\text{Fe}_2\text{S}$  and Fe. The sulphide of carbon reduces Ca, Si, &c. in the same way, transforming these substances into sulphides.

2. **The Raw Smelting Process.**—When the mixture is properly composed, the basic earths ( $\text{CaO}$ ,  $\text{MgO}$ ,  $\text{Al}_2\text{O}_3$ ) and the oxides which are more difficult to reduce ( $\text{FeO}$ ,  $\text{MnO}$ ,  $\text{ZnO}$ ) combine with the silica, and form a slag, whilst the undecomposed sulphides, or those reduced from the sulphates (Fe, Mn, Cu, Zn, Sb, As, &c.), receive the silver and form a matt. The metals from oxides which are easier to reduce, combine with the sulphur which is present in excess. Sulphide of zinc partly enters the matt as such, and partly becomes decomposed and enters the slag as an oxide; some metallic fume containing zinc is also formed.

The smelting process may be carried on—

a. *In cupola furnaces* constructed in the form of sump furnaces, sometimes with one, and sometimes with more than one tuyere, with or without condensation chambers; these are very advisable on account of the strong blast required.\* According to experiments made at Freiberg, furnaces with two tuyeres, with or without a partition wall, give a larger production, and allow a saving in labour and fuel compared with furnaces with one tuyere. The smelting is conducted either with no nose or with a short one (Lend). The height of the furnace depends on the fusibility of the mixture, on the amount of zinc contained in the ore, on the nature of the fuel, &c. The interior form of the furnaces approaches that of Vogl's lead furnaces (page 78); the raw furnaces being some inches shorter and narrower. Occasionally these furnaces are furnished with boshes, like iron blast furnaces, which increase the temperature (Lend); in some cases they have perpendicular walls (Hungary).

The furnaces require a suitably enlarged hearth to effect a larger production and give a higher temperature. Hot blast effects a saving of fuel, enables a larger quantity of mixture to be smelted, and allows longer operations (Kongsberg).

b. *In reverberatory furnaces*, which at Freiberg, for instance, have been proved to possess the following advantages

\* Oesterr. Ztschr., 1854, p. 258.

over the cupola furnaces:—The quantity smelted is three times larger; a saving of fuel and labour is effected; a larger addition of ores containing blende may be given; the most refractory ores may be used; and an addition of pyrites avoided, as in reverberatory furnaces less sulphur is used than in cupola furnaces. Comparisons show that the money saved by the process in reverberatory furnaces is 15 per cent, whilst the gain by cupola furnaces only amounts to 5 per cent. But the raw matt produced in reverberatory furnaces from ores with blende contains more zinc than such a matt produced in cupola furnaces, which necessitate a more perfect roasting of the flux ores.

The products from this smelting are chiefly—

a. Raw Matt, which is composed as follows:—

	Fe.	Pb.	Cu.	Zn.	Ag.	Ni.	Sb.	As.	S.
1.	58'00	12'25	2'00	3'00	0'14	—	—	2'00	18'75
2.	66'41	6'48	1'50	0'60	0'15	—	—	5'56	19'27
3.	62'35	5'22	1'26	—	0'10	—	—	10'28	19'34
4.	46'89	2'45	5'00	6'30	0'1261	—	trace,		36'97

Nos. 1 to 3 are raw matts from Freiberg, and No. 4 matt from Schemnitz: the latter contains 0'0041 per cent of gold.

This matt is either, after a previous roasting, fused directly with lead, or it is previously concentrated in order to enrich it in silver. To concentrate the raw matt, it is first roasted, not too strongly, in mounds, when sulphates, arseniates, and antimonates, and oxide of iron will be formed, whilst a part of the metallic sulphides, antimonides, and arsenides remains undecomposed. If the roasting mass is now submitted to a reducing and purifying smelting with a sufficient quantity of siliceous substances, so that a mixture of mono- and sub-silicated slags may be formed, a matt richer in copper and silver, and poorer in iron (concentration matt), will result, the iron being chiefly scorified. A more highly silicated slag, requiring a higher temperature for smelting, would cause the reduction of iron and the formation of iron deposits; and this would also be the case if sub-silicated slags were formed for want of silica, whilst at the same time an incomplete separation of the matt would take place. Ores containing antimony and arsenic, if they are too strongly roasted, or if the

mixture is too rich in iron, or if the pressure of the blast is too strong, cause the formation of a very hot matt emitting sparks, from which a speiss, mostly rich in noble metals, separates. This speiss can only become imperfectly desilverised, though it may be very strongly roasted. Ores richer in silver are sometimes added at this concentration smelting (Kongsberg, Lower Hungary).

Great care must be taken not to carry on the concentration of the matt too far, or over rich slags will occur owing to their including particles of matt. These disadvantages have hindered the introduction of this concentration of matt at Freiberg.\*

*b. Raw Slags*; these, on account of their siliceous nature, are used as building material and as a purifying flux in later matt smeltings, otherwise they are thrown aside.

*c. Smoke* containing silver; this is worked up in the raw concentration smelting.

*d. Metallic Fume* rich in Zinc; this is either worked up for the extraction of zinc or is thrown away.

#### Illustrations of the Raw Smelting Process in Cupola Furnaces.

At Kongsberg, in Norway, poor schlich with from  $\frac{3}{4}$  to 2 ozs., and slime with  $\frac{1}{2}$  oz. of silver per cwt., in admixture with smoke, soot, slags, and iron pyrites, are worked in a cupola furnace 14 feet high, with a large fore hearth, a hot blast of 190° C., and a pressure of 3.5 inches of mercury, for the production of raw matt with 4 or 5 ozs., smoke with 1 oz., and valueless slags with from 0.06 to 0.03 oz. of silver. The raw matt of 1859 contained on an average—

S . . . . .	29.969
Fe . . . . .	63.525
Cu . . . . .	2.500
Zn . . . . .	1.013
Ag . . . . .	0.329
Ni . . . . .	0.146
Co . . . . .	0.128
Mn . . . . .	0.148
Se . . . . .	0.046

The As and Sb were not determined. This matt is concentrated and fused with lead.

\* Freiburger Jahrbuch, 1845, p. 56; 1846, p. III.

In 1859, 778 tons, 3 cwts. of schlich and slime, 282 tons, 10 cwts. of iron pyrites, and 580 tons of slags, produced 270 tons, 4 cwts. of raw matt, containing  $5\frac{1}{4}$  ozs. of silver, 48 tons, 9 cwts. of fume, and 1,340 tons of slags. Of the total amount of silver contained in the mixture 91 per cent entered the raw matt, 3·7 per cent the smoke, and 5·3 per cent the slags. In 24 hours, 12 tons, 13 cwts. of mixture (without smoke), 5·6 tons of them schlich, have been worked; 2 cwts. of mixture require 5·6 cubic feet of charcoal.

At Lend\* (Salzburg), the ores at Böckstein and Raurist occur in gneiss, chlorite, mica slate, quartz, and calc spar, associated with blende, iron pyrites, and arsenical pyrites, varying in their amount of gold, silver, and raw matt; as they contain an excess of silica, they are mixed with so much basic slags, lime, and roasted matt, that a slag is formed consisting of—

SiO <sub>2</sub>	. . . . .	51·02
Al <sub>2</sub> O <sub>3</sub>	. . . . .	2·16
CaO	. . . . .	15·40
FeO	. . . . .	19·75
MgO	. . . . .	8·75

and containing small quantities of As, Mn, Zn, Cu, and S.

The smelting of the mixture is conducted in sump furnaces, as represented by Figs. 64 and 65. *a*, is the sump; *b*, the fore hearth; *c*, the tuyeres; *d*, the outside basins; and *e*, the condensation chambers.

8 tons, 15 cwts. of mixture, containing on an average 0·047 lb. of auriferous silver, are smelted in 24 hours, causing a loss of not more than 0·26 per cent of metal; 1 cwt. of mixture consuming 3·4 cubic feet of coal. The products are from 40 to 45 per cent (of the mixture) of raw matt, containing—

Fe	. . . 55·1	per cent.	Ca	. . . 1·2	per cent.
Cu	. . . 4·3	,,	As	. . . 1·3	,,
Zn	. . . 3·7	,,	Sb	. . . 1·2	,,
Pb	. . . 2·1	,,	S	. . . 27·9	,,
Ni	. . . 0·8	,,			

To concentrate the matt it must be roasted in mounds with 3 or 4 fires, so far as to give not more than 40 per cent of matt,

\* Oesterr. Ztschr., 1862, p. 297. B. u. h. Ztg., 1862, p. 424.  
 † COTTA, Erzlagertstätten, ii., p. 318.



FIG. 64.

www.libtool.com.cn

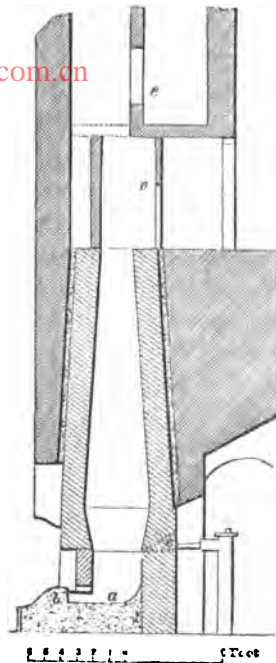

and melted with pyritic schlich and pounded quartz in the raw matt furnace, the hearth of which is 10 or 12 inches wider, and with a pressure of only two lines of mercury. The concentrated matt contains about 0.26 lb. of silver per cwt., which is melted together with lead products; the slag is thrown aside.

FIG. 65.

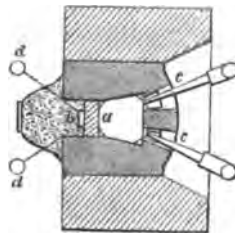

At the smelting works at Lower Hungary\* (Schemnitz,

\* Oesterr. Ztschr., 1857, p. 332.

Kremnitz, Neusohl, Zsarnowitz), from 10 to 22 per cent of Dürr ores, containing 0·105 to 0·14 lb. of auriferous silver, from 20 to 30 per cent of schlich with 0·002 to 0·14 of silver, and from 70 to 50 per cent of schlich containing pyrites and 0·002 to 0·101 lb. of silver, besides dross and smoke, are mixed, so as to contain an average amount of 0·04 to 0·067 lb. of silver per cent, and as the mixture contains much silica, an addition is made of from 10 to 20 per cent of limestone, and from 50 to 80 per cent of basic slags.

The furnaces in use\* have two tuyeres, trapezoidal in section. Their dimensions are:—Height 22 feet; width in the back, 60 inches; in front, 36 inches; depth, 50 inches; height of the tuyeres above the hearth-stone, from 26 to 28 inches; distance from each other, 14 inches; upper declination, 2°; lower, 1°; projection into the furnace, 6 inches; depth of the sump, 28 inches; diameter of the tuyeres, 2½ inches; pressure of blast, 16 lines.

In a week, from 27 tons, 10 cwts. to 35 tons of ores and schlich are worked; 5 tons consuming about 900 cubic feet of soft charcoal. The loss of auriferous silver amounts to from ½ to 1¼ per cent; the resulting products are—

a. 20 or 30 per cent of **Raw Matt**, containing from 0·14 to 0·21 lb. of auriferous silver. This is roasted four or five times, and melted with lead.

b. 6 or 8 per cent of **Furnace Ends**, containing from 0·03 to 0·12 lb. of auriferous silver, which are worked up in the next operation.

c. **Slags**, which are thrown aside (containing 0·0005 to 0·001 lb. of auriferous silver).

d. 2 or 3 per cent **Smoke**, which is treated as the residues.

e. **Metallic Soot**. This is composed as follows:—

Fe	. 30·12	per cent.	Ag	. . 0·028357	per cent.
Pb	. 2·00	„	As & Sb	traces	„
Cu	. 1·20	„	S	. . 15·34	„
Zn	. 4·06	„	Gangue	47·97	„
Au	. 0·0009392	„			

\* KARSTEN'S Archiv., 2 R., ix., 405, 439. ERDMANN'S Journal für pract. Chemie, i., 193, 479. WEHRLE'S Hüttenkunde, ii., 401. Oesterr. Ztschr. 1862, No. 39.

At the smelting works at Barnaul, Pawlowsk, Loktewsk, and Smejensk (Altai), silver ores are worked containing on an average 0.05 lb. of silver per cwt. The silver produced from these ores contains 3 or  $3\frac{1}{2}$  per cent of gold.

The usual mixture is composed of—

About 65 cwts. of silver ores containing 0.05 lb. of silver per cwt. ;  $\frac{1}{2}$  to  $\frac{1}{2}$  of them also contain baryta.

From 11 to 19 cwts. of desilverised raw matt ;

From 13 to 16 cwts. of limestone ; and

From 13 to 16 cwts. of lead ore slags.

The smelting process is carried on in cupola furnaces 12 or 16 feet high, 3 feet deep, and  $2\frac{1}{2}$  and 2 feet broad respectively in the back and front. The furnaces have one tuyere, and the nose is kept long and dark. In 24 hours a mixture of about  $6\frac{1}{2}$  tons is worked, and 1 cwt. of ores consume from 80 to 100 lbs. of charcoal. From the smelting result—

*a. Raw Matt* with about 0.0588 per cent of silver, from 25 to 35 per cent of Fe, 7 to 15 per cent of Cu, 15 to 20 per cent of Ba, 3 to 8 per cent of Pb, nearly as much zinc, and a little antimony. The rich matts also contain from 2 to 5 per cent of Na ; the matt is desilverised by fusion with lead.

*b. Impure Slags*, obtained before and after the tapping off ; these are re-smelted.

*c. Pure Slags*, consisting of from 50 to 55 per cent of silica, from 5 to 15 per cent of baryta, 7 to 20 per cent of lime, 10 to 18 per cent of protoxide of iron, 2 to 4 per cent of alumina, and small amounts of MgO, PbO, CuO, KO, and NaO. They are usually tri-silicates, or mixtures of bi- and tri-silicates, and are worked together with argentiferous lead ores.

Guerngross† has successfully separated the matt intermixed with the slags, by dressing them.

*d. Metallic Smoke*.—For the condensation of this different experiments have been made.‡

\* B. u. h. Ztg., 1853, p. 137. COTTA, Gangstudien, ii., 477.

† B. u. h. Ztg., 1852, No. 31.

‡ Bgwkd., 1853, p. 417.

## 2. Lead Process with Argentiferous Matts.

The desilverising of raw copper and lead matts may be effected by melting them in a raw state with metallic lead (Eintränken, hydrostatic smelting), or by smelting the roasted matt with roasted or raw lead ores, or lead products from the cupelling process. If the lead used for this process contains copper (Kongsberg), or if some black copper is added, the desilverising will be facilitated, as the copper will enter the matt while separating silver from sulphide of silver (*Abdarr* process).

### Desilverising by means of Metallic Lead.

This process is founded upon the behaviour of metallic lead towards sulphide of silver; the sulphide of silver is decomposed by the metallic lead, forming sulphide of lead, and the liberated silver enters into combination with the excess of lead present. This desilverising takes place more perfectly when the contact between the fused matt and the liquid lead is more intimate; yet the decomposition is never complete, and all that can be done is to extract as much of the silver as possible by a repeated treatment of the matt with fresh lead, so as to compensate for the cost of smelting and the loss of lead, and to make treatment by the liquation process, of the black copper produced from the matt, unnecessary.

This process is chiefly in vogue in localities where fuel and lead ores are not abundant. By smelting raw matt with lead ores in cupola furnaces a more perfect desilverising takes place, as lead at the moment of reduction possesses the greatest affinity for silver and gold; but a greater loss of lead and copper occurs than when the matts are treated by metallic lead at a lower temperature. Desilverising in this way is more imperfect, as it is impossible to keep the matt in contact with the liquid lead for a sufficiently long time. The amount of copper in the raw lead produced by this process is smaller than that contained in raw lead which has been produced by smelting the roasted matt with lead or litharge in cupola furnaces.

The molten matt is usually stirred with liquid lead in a hearth; Gren's process (hydrostatic smelting) of making the fused matt ascend in thin jets through the liquid lead has been tried in Müsen,\* on the Altai,† and on the Upper Hartz without giving satisfactory results.

The raw matt for this process is either smelted in separate hearths (Altai), or the liquid matt resulting from the concentration process is used for it (Kongsberg).

### Illustrations of Desilverising Matt by Fusion with Lead.

At the smelting works on the Altai, the raw matt containing 0·05 lb. of silver is smelted in quantities of about  $2\frac{1}{2}$  tons., in hearths about  $4\frac{1}{2}$  feet in diameter and 3 feet in height, furnished with three tuyeres. After the matt has been smelted the slags are removed, the surface covered again with burning coals, and upon these 16 cwts. of lead in small ingots are put opposite the tuyeres. The lead melts, permeates the matt, and collects at the bottom of the hearth; it is then repeatedly stirred up with green wooden poles to bring it in contact with the matt, afterwards allowed to settle, and then tapped off. The matt is thus treated three or four times, each time with 16 cwts. of lead, till the amount of silver it contains has decreased to about 0·012 lb. The raw lead of the first treatment, containing about 0·126 lb., is cupelled; that of the second, containing about 0·0756 lb., is used for a repetition of the first treatment; and that of the third, containing about 0·037 lb., for the second treatment. Each hearth will effect three such operations in 24 hours. The desilverised raw matt is used up in the raw or lead process.

At Kongsberg the raw matt is submitted to the following operations:—

*a.* **Fusion of Raw Matt with Lead.**—The matt is broken into pieces about 2 cubic inches in size, and roasted four times in mounds capable of holding 50 tons. It is then concentrated in cupola furnaces, together with the richer schlich

\* ERDMANN'S *Journal für ök. Chemie*, xvi., 48. LAMPADIUS, *Fortschritte*, 1839, p. 75.

† *B. u. h. Ztg.*, 1845, p. 403.

containing from 5 to 7 ozs. of silver per cwt., and smoke containing 5 or 6 ozs. of silver per cwt.; and the concentrated liquid matt in the tap hearth is stirred with raw lead containing from 2 to 5 lbs. of silver per cwt. The latter is cupelled when it is enriched up to 12 or 15 lbs. According to Samuelsen, the formation of iron deposits increases in proportion as the roasted raw matt diminishes; this is the reverse of what takes place in the raw smelting. A larger addition of roasted matt again dissolves the iron deposits formed, and for the following reason:—One part of carbon only possesses a definite smelting and reducing reaction by which the iron deposits are formed; if more sulphuretted raw matt is used, its metallic sulphides will remain undecomposed, and the sulphur it contains has a solvent action upon deposits which have been already formed. At the same time, slags difficult to fuse, and containing peroxide of iron, are formed, from which matt separates with difficulty. For this reason a small deposit of iron on the hearth is found advantageous. The slags contain  $\frac{1}{4}$  or  $\frac{1}{2}$  oz. and more of silver, depending on the more or less formation of iron deposits (page 118).

The products of this process are:—**Slags**, which are used for the raw process; **Smoke**, containing from 5 to 8 ozs. of silver; and **Matt**, containing  $1\frac{1}{2}$  to 2 lbs. of silver. This is used in the subsequent process. In 1859, 270 tons, 4 cwts. of raw matt were smelted after roasting with 300 tons of rich schlich and some slags in 56 days, or 11 tons, 3 cwts. of mixture in 24 hours; 175 lbs. of the mixture consumed 3.5 cwts of coal.

*b. Desilverising the Lead Matt.*—This matt is smelted with the metallic soot from the last process in a low cupola furnace, and fused with cupriferous raw lead containing  $1\frac{1}{2}$  or 2 lbs. of silver, so as to increase the amount of silver in the lead to  $4\frac{1}{2}$  or 5 lbs., while the silver in the matt decreases to  $12\frac{1}{2}$  ozs. The copper contained in the raw lead extracts silver from the matt, and the resulting matt is poorer in silver and richer in copper. A matt from this operation was found to contain—

Fe . . . . .	49·401	Ni . . . . .	0·492
Cu . . . . .	13·572	Co . . . . .	0·295
Pb . . . . .	6·760	As and Sb . . . . .	1·714
Zn . . . . .	6·459	S . . . . .	23·442
Ag . . . . .	0·880		

By the processes *a* and *b* were produced from the above stated quantity of matt, 50 tons, 15 cwts. of desilverised lead matt containing 888 lbs. of silver; 13 tons, 16 cwts. of raw lead containing 3,592½ lbs. of silver for the cupelling process; 14 tons, 3 cwts. of raw lead for the fusion process; also 19 tons, 17 cwts. of smoke, and 473 tons, 14 cwts. of slags. 1 lb. of silver causes an average loss of 2·4 lbs. of lead.

*c. Fusion of the Desilverised Lead Matt with Lead.*—The matt is roasted two or three times, and smelted in a cupola furnace together with metallic fume from process *a*, and with ore dust from the walls of the mounds; it is then fused with poor cupriferous raw lead, by which process the amount of silver in the latter is increased to 9 or 10 lbs. Smoke containing 5 or 6 ozs. of silver, and copper matt containing 40 per cent of copper and 1½ or 2 lbs. of silver, are also produced.

*d. Desilverising the Copper Matt.*—This matt is smelted several times in a low cupola furnace with poor raw lead, and then fused with pure English lead, which becomes gradually enriched by these processes till it is fit for the cupelling process. The copper matt is desilverised to ¼ oz. or even less, whilst the raw lead contains at each smelting with litharge, five times as much silver as it contained when in the matt, and if pure lead is present in the hearth, three times as much. Desilverised copper matt has the following composition:—

Fe . . . . .	22·817	Co . . . . .	0·388
Cu . . . . .	38·117	As and Sb . . . . .	1·312
Pb . . . . .	11·548	S . . . . .	22·561
Ni . . . . .	0·830		

The copper matt after having been roasted 10 or 12 times is smelted for the production of black copper, which is refined in a reverberatory furnace.

All the different processes are carried on by hot blast, and they cause a total loss of 1·5 to 1·75 lbs. of lead for each

0.5 lb. of fine silver produced. Besides this, 0.5 to 1 per cent of copper is obtained. In the years 1857-58 the annual production of silver exceeded 15,000 lbs.; this production was later reduced to 10,000 or 12,500 lbs., and will probably continue to decrease.

### Desilverising the Matt by means of Lead Ores and Products.

These processes are intended for smelting argentiferous matt, and sometimes also rich silver ores, together with substances containing lead, in order to collect the silver in the reduced lead, and to concentrate in the matt the copper which is present in the mixture. The matt requires repeated fusions with lead to effect a sufficient desilverising.

### Illustrations of the Process.

At the smelting works at Lower Hungary the matts resulting from the raw smelting (page 42) are submitted to the following processes:—

*a. Fusion for the Production of Rich Lead.*—5 tons, consisting of 30 or 40 per cent of Dürr ores (page 143), containing 0.14 lb. of auriferous silver, and from 10 to 20 per cent of silver ores roasted with plumbiferous residues containing 0.14 lb. or more of silver, and from 40 to 60 per cent of roasted lead ores, were mixed with 1½ to 2 tons of raw matt which had been 4 or 5 times roasted, 15 to 20 cwts. of products of the cupelling process, some dross, smoke, and basic slags, and occasionally with from 1 to 4 per cent of limestone. The ore mixtures contain from 0.15 to 0.245 lb. of auriferous silver and from 15 to 25 lbs. of lead. The smelting is conducted in cupola furnaces 18 feet high; a total mixture of from 13 to 18 tons, containing from 7 to 10 tons of ore and schlich, are smelted weekly, consuming about 1,000 cubic feet of soft coal. The lead absorbs 85 to 95 per cent of the silver, and 95 to 99 per cent of the gold contained in the total mixture.

The products are from 88 to 92 per cent (calculated for the total mixture) of rich lead, containing 0.7 or 0.8 lb. of



auriferous silver; from 6 to 12 per cent (calculated for ore and schlich) of rich matt, containing 0·11 or 0·16 lb. of auriferous silver; from 6 to 12 lbs. of lead, and from 1½ to 5 lbs. of copper; slags, containing 0·001 or 0·002 lb. of auriferous silver, and ¼ to 1 lb. of lead residues and smoke.

*b. Rich Lead Smelting of the Matt.*—The matt, after being roasted two or three times, is mixed with from 10 to 20 per cent of siliceous ores poor in silver and gold, with a little lead slag and the products from the cupelling process, and smelted in cupola furnaces, producing from 88 to 95 per cent of lead containing 0·35 or 0·45 lb. of silver; 20 or 30 per cent of matt containing from 0·06 to 0·1 lb. of silver, 8 or 10 lbs. lead, and from 8 to 16 lbs. of copper; furnace ends; and slags containing 0·0005 to 0·001 lb. of silver, and ¼ to ½ lb. of lead.

*c. Treatment of the Matt Produced in the Last Process.*—This is roasted from two to four times, according to its amount of copper, and again smelted in order to concentrate its copper, and to partly extract its lead. The result is from 40 to 60 per cent of lead, containing from 1·0 to 1·5 lbs. of silver, from 20 to 25 per cent of matt, with from 0·15 to 0·26 lb. of Ag, from 40 to 45 lbs. of Cu, and from 5 to 8 lbs. of Pb.

At Lend (Salzburg), matt containing 0·26 lb. of auriferous silver (page 229) is roasted 2 or 3 times, and mixed with sufficient lead products for the mixture to contain from 100 to 120 lbs. of lead for each lb. of silver. The furnace in use is similar to that described on page 229. From 11½ to 12½ tons of mixture are smelted in 24 hours, and 75 per cent of auriferous silver enters into combination with lead, in the proportion of 90 per cent of gold to 73 per cent of silver. A slag of the following composition is formed in order to lessen the scorification of lead:—

SiO <sub>3</sub>	. . . . .	27·45
FeO	. . . . .	56·52
CaO	. . . . .	10·19
MgO	. . . . .	3·48
Al <sub>2</sub> O <sub>3</sub>	. . . . .	1·25

The resulting matt is again desilverised by a larger quantity of lead.

In the years 1859-62, 81·825 per cent was produced of the noble metals under treatment, and 18·175 per cent remained in the smelting products; the loss of lead amounted to 8·275 per cent. [www.libtool.com.cn](http://www.libtool.com.cn)

At Freiberg the roasted slag raw matt (page 138) is smelted together with roasted lead ores and fluxes, as stated on page 127. The results of the different smelting processes at Freiberg during the year lately past are given on the following pages.

A difference is made between rich and poor lead smelting; the rich Dürr ores are worked by the former process in a raw state, causing the resulting raw lead to contain as much as 2 per cent of silver, which is treated directly by the cupelling process.

The following synopsis of operations at the smelting works at Halsbrücke and at Mulden may be of value:—

*a. Ore Smelting.*—The ore mixture consisted of—

<i>At Halsbrücke.</i>	<i>At Mulden.</i>
24·17 per cent lead ores.	33·54 per cent lead ores.
58·44 " galena.	51·61 " galena.
19·39 " Dürr and copper ores.	14·85 " Dürr and copper ores.

And contained on an average—

0·1398 lb. silver.	0·1561 lb. silver.
36·28 " lead.	33·29 " lead.

For every 5 tons of the ore mixture were added—

48·75 cwts. matt.	44·40 cwts. matt.
0·82 " lime.	— " lime.
0·49 " limestone.	— " limestone.
0·39 " fluor spar.	— " fluor spar.
0·12 " loamy substances.	— " loamy substances.
2·24 " iron cinders.	0·33 " iron cinders.
0·99 " coal slags.	4·25 " coal slags.

5 tons of ore mixture and raw matt required for roasting—

5·4 cubic feet wood.	0·86 cubic feet wood.
18·48 cwts. slate coal.	18·15 cwts. slate coal.
—	0·16 " coke.
—	103 cubic feet non-caking coal.
0·002 basket wood chips.	0·004 basket wood chips.

The roasting cost for 1 cwt. of ore mixture and raw matt were—

1·843d. for fuel.	2·004d. for fuel.
1·365d. " labour.	1·297d. " labour.

In 24 hours were smelted—

*At Halsbrücke.*

49'28 cwts. ore mixture.

24'02 " raw matt.

43'39 cwts. coke.

0'15 basket charcoal.

— " turf.

The smelting cost for 1 cwt. of ore mixture amounted to—

7'22d. for fuel.

3'158d. " labour.

5 tons of mixture of ores, matt, and intermediate products

yielded—

21'19 cwts. lead—

containing 0'5481 lb. silver.

2'77 cwts. matt—

containing 0'2411 lb. silver.

" 30'44 " lead.

" 9'53 " copper.

The total mixture produced—

75'67 per cent lead slags.

The total cost for 1 cwt. of ore mixture amounted to—

18. 4d.

Namely 0'250d. for fluxes.

10'279d. " fuel.

5'378d. " labour.

0'138d. " ore dressing  
and blast.

*At Mulden.*

49'45 cwts. ore mixture.

21'95 " raw matt.

43'67 cwts. coke.

0'04 basket charcoal.

0'02 " turf.

7'262d. for fuel.

3'175d. " labour.

20'75 cwts. lead—

containing 0'5709 lb. silver.

1'79 cwt. matt—

containing 0'26 lb. silver.

" 17'47 " lead.

" 15'04 " copper.

73'74 per cent lead slags.

18. 3'5d.

Namely 10'161d. for fuel.

5'044d. " labour.

0'381d. " ore dressing  
and blast.

**b. Lead Slag Raw Smelting.**—5 tons of lead slags were melted together with—

92'56 cwts. ores and flux ores.

Namely 27'30 cwts. raw.

63'78 " roasted.

1'48 " burned.

70'07 cwts. ores and flux ores.

Namely 28'10 cwts. raw.

29'85 " roasted.

12'12 " burned.

5 tons of ores and fluxes required for roasting and burning—

22'50 cwts. slate coal.

0'91 " coke.

5'35 " iron cinders.

0'324 cubic feet wood.

— " wood chips.

The cost for 1 cwt. of ores and fluxes amounted to—

2'490d. for fuel.

1'59 d. " labour.

In 24 hours were smelted—

104'50 cwts. ores and fluxes.

121'94 cubic feet slags.

17'66 cwts. slate coal.

— " coke.

1'15 " iron cinders.

0'756 cubic feet wood.

0'108 " wood chips.

1'905d. for fuel.

0'993d. " labour.

98'56 cwts. ores and fluxes.

138'02 cubic feet.

Five tons of ores, fluxes, and slags required for smelting—

47'95 cwts. slate coal.

— " cinders.

48'64 cwts. slate coal.

3'08 cubic feet of cinders.

Smelting cost per 1 cwt. of mixture—

<i>At Halsbrücke.</i>	<i>At Mulden.</i>
4·72d. for fuel.	5·00d. for fuel.
1·134d. „ labour.	1·046d. „ labour.
From 5 tons mixture were produced—	
25·40 cwts. matt—	24·08 cwts. matt—
containing 0·13 lbs. silver.	containing 0·12 lbs. silver.
„ 6·53 „ lead.	„ 5 „ lead.
„ 1·65 „ copper.	„ 2 „ copper.

From 5 tons mixture were produced and thrown aside—

74·59 cwts. slags.	75·92 cwts. slags.
--------------------	--------------------

The ore and slag-smelting for 1 cwt. of the used ores and fluxes cost—

0·098d. for fluxes.	— for fluxes.
11·013d. „ fuel.	11·545d. „ fuel.
4·389d. „ labour.	4·202d. „ labour.
0·089d. „ dressing and blast.	0·212d. „ dressing and blast.
<hr/> 1s. 3·499d.	<hr/> 1s. 3·959d.

Of the silver contained in the ore mixture there were obtained—

83·25 per cent from the raw lead.	84·72 per cent from the raw lead.
4·79 per cent from the matt of the ore smelting.	2·57 per cent from the matt of the ore smelting.
11·66 per cent from the matt of the reverberatory smelting.	13·01 per cent from the matt of the smelting in reverb. furnace.
0·26 per cent from the smoke and furnace ends.	0·48 per cent from the smoke and furnace ends.

Of the lead collected were obtained—

81·80 per cent from the raw lead.	86·10 per cent from the raw matt.
3·28 per cent from the matt of the ore smelting.	1·31 per cent from the matt of the ore smelting.
9·02 per cent from the matt of the reverberatory furnace.	6·29 per cent from the matt of the reverberatory furnace.
0·39 per cent from the smoke and furnace ends.	1·29 per cent from the smoke and furnace ends.

**c. Matt Smelting.**

Five tons of matt required for burning—

14·04 cubic feet wood.	14·04 cubic feet wood.
1·32 cwts. slate coal.	1·32 cwts. slate coal.

Five tons of matt, ore, and furnace ends required for roasting—

20·56 cwts. slate coal.	23·06 cwts. slate coal.
— „ cinders.	22 „ cinders.

The cost of roasting 1 cwt. of matt, ores, and furnace ends was—

2·353d. for fuel.	3·087d. for fuel.
1·785d. „ labour.	1·921d. „ labour.

To 5 tons of matt, at the smelting and concentration, were added—

*At Halsbrücke.*

7'99 cwts. ores and fluxes.  
0'36 " residues.

*At Mulden.*

15'41 cwts. ores and fluxes.  
— " residues.

The mixture contained, on an average—

0'2324 lb. silver.  
20'90. " lead.  
12'49 " copper.

0'1537 lb. silver.  
17'08 " lead.  
12'87 " copper.

Five tons of matt, ores, and fluxes were mixed at the matt smelting and concentrating with—

3'02 cwts. hearth ends.  
8'39 " litharge.  
24'64 " slags of the litharge re-  
ducing process.  
7'14 " concentration slags.  
3'01 " fluor spar.  
1'25 " sulphate of baryta.

20'02 cwts. slags of the litharge re-  
ducing process.  
5'08 " concentration slags.  
4'55 " fluor spar.  
5'43 " sulphate of baryta.

In 24 hours, of matt, ore, and furnace ends there were smelted and concentrated—

61'21 cwts.

59'03 cwts.

Five tons of matt consumed in the smelting process—

0'1 basket charcoal.  
44'0 cwts. coke.

15 cwts. slate coal.  
0'1 basket charcoal.  
58 cwts. coke.  
0'02 basket turf.

The smelting cost for 1 cwt. amounted to—

0'280d. for fluxes.  
7'448d. " fuel.  
2'469d. " labour.

0'668d. for fluxes.  
11'373d. " fuel.  
2'785d. " labour.

The matt smelting process yielded, for 5 tons of matt, ore, and furnace ends—

26'93 cwts. copper matt.  
containing 0'243 lb. silver.  
" 15' " lead.  
" 31' " copper.  
3'96 cwts. plumbiferous copper.  
23'76 lbs. concentrated matt.  
containing 0'24 lb. silver.  
" 50 " copper.  
26'26 cwts. raw lead.  
containing 0'4875 lb. silver.  
0'40 cwt. speiss.  
containing — lb. silver.  
" — " copper.  
" 27 " nickel and  
cobalt.

15'22 cwts. copper matt—  
containing 0'2544 lbs. silver.  
45'01 lbs. copper.  
45'41 cwts. copper matt.  
containing 0'2146 lb. silver.  
" 12'92 " lead.  
" 38'30 " copper.  
12'80 cwts. plumbiferous copper.  
10'20 lbs. concentrated matt.  
containing 0'20 lb. silver.  
" 54 " copper.  
13'35 cwts. raw lead.  
containing 0'5933 lb. silver.  
0'63 cwt. speiss.  
containing 0'40 lb. silver.  
" 23'8 " copper.  
" 17'4 " nickel and  
cobalt.

Five tons of mixture produced—

60'83 cwts. lead matt slags.

68'66 cwts. lead matt slags.

**d. Copper Matt Concentration Process.**—The matt for concentrating in reverberatory furnaces contained on an average—

[www.libtool.com.cn](http://www.libtool.com.cn)

*At Halsbrücke.*

*At Mulden.*

0·2509 lb. silver.  
47·04 „ copper.

0·1974 lb. silver.  
40·74 „ copper.

Five tons of copper matt for the mixture consisted of—  
14·06 per cent. raw matt.      41·26 per cent. raw matt.  
85·94 „ roasted matt.      58·74 „ roasted matt.

Five tons of roasted copper matt consumed—  
25·38 cwts. slate coal.      19·28 cwts. slate coal.  
13 cubic feet cinders.

and cost per cwt—  
2·554d. for fuel.      2·148d. for fuel.  
1·732d. „ labour.      1·038d. „ labour.

Five tons of matt were smelted with—  
10·03 cwts. ores.      33·75 cwts. ores.  
11·34 „ fluxes (containing baryta).      14·58 „ fluxes (containing baryta).  
24·20 „ sulphate of baryta.      16·03 „ sulphate of baryta.  
18·79 „ concentration slags.      31·34 „ concentration slags.  
— „ baryta slags.      16·03 „ baryta slags.

In 24 hours were smelted—  
111·58 cwts. copper matt.      73·62 cwts. copper matt.  
26·19 „ ores and fluxes.      35·82 „ ores and fluxes.  
27·00 „ sulphate of baryta.      11·89 „ sulphate of baryta.  
20·96 „ slags.      35·13 „ slags.

One cwt. of copper matt consumed in the smelting process—  
0·91 cwt. slate coal.      1·13 cwt. slate coal.

The smelting cost per 1 cwt. of copper matt was—  
1·364d. for fluxes.      0·489d. for fluxes.  
9·245d. „ fuel.      11·881d. „ fuel.  
2·148d. „ labour.      3·207d. „ labour.

From 5 tons of matt were produced—  
97·38 cwts. matt.  
Namely 90·60 cwts. concentration matt.  
64·71 cwts. matt.      containing 0·2745 lb. silver.  
    Namely 59·16 cwts. concentration matt.      „ 69·24 „ copper.  
    containing 0·40 lb. silver.      6·78 cwts. copper matt.  
    „ 70 „ copper.      containing 0·23 lb. silver.  
5·5 cwts. copper matt.      „ 20 „ copper.  
    containing 0·22 lb. silver.      0·58 cwt. speiss.  
    „ 13 „ copper.      containing 0·40 lb. silver.  
1·23 cwt. plumbiferous copper.      „ 23·8 „ copper.  
    containing 0·90 lb. silver.      „ 17·4 „ nickel and cobalt.  
    „ 44 „ copper.

The mixture produced, of slags which were thrown aside—

<i>At Halsbrücke.</i>	<i>At Mulden.</i>
60·36 per cent.	62·29 per cent.
The total smelting cost per 1 cwt. of matt was—	
4·408d. for ores and flux ores.	5·390d. for ores and flux ores.
1·364d. „ fluxes.	0·480d. „ fluxes.
11·442d. „ fuel.	13·142d. „ fuel.
3·637d. „ labour.	3·817d. „ labour.
1·435d. „ dressing.	0·646d. „ dressing.
<hr/> 1s. 10·286d.	<hr/> 1s. 11·484d.

*e.* Smelting of the Slags obtained by Concentrating Lead and Copper Matt.—Five tons of slags were smelted together with—

72·01 cwts. ores and flux ores.	123·35 cwts. ores and flux ores.
Namely 17·45 cwts. raw.	Namely 28·95 cwts. raw.
54·56 „ roasted.	78·38 „ roasted.
— „ burned.	16·02 „ burned.

One cwt. of ore and flux ore contained—

0·0516 lb. silver.	0·0494 lb. silver.
0·54 „ copper.	0·95 „ copper.

Cost for roasting and burning—

2·853d. for fuel.	2·869d. for fuel.
2·083d. „ labour.	1·394d. „ labour.

In 24 hours were smelted—

123·63 cwts. slags.	95·21 cwts. slags.
89·02 „ ores.	117·45 „ ores.

One cwt. of mixture required for smelting—

0·48 cwt. slate coal.	0·51 cwt. slate coal.
-----------------------	-----------------------

Costing per 1 cwt.—

4·830d. for fuel.	5·300d. for fuel.
1·161d. „ labour.	1·131d. „ labour.

From 5 tons of mixture were produced—

20·63 cwts. matt—	19·47 cwts. matt—
containing 0·175 lbs. silver.	containing 0·15 lbs. silver.
„ 5 „ lead.	„ 5 „ lead.
„ 5 „ copper.	„ 5 „ copper.

Of produced slags there were thrown aside—

79·37 per cent.	80·33 per cent.
-----------------	-----------------

Total cost of the lead matt smelting, copper matt concentration, and the slag smelting per 1 cwt. of matt, amounted to—

5s. 8·362d.	11s. 6·6d.
-------------	------------

The total cost for ore and flux ores amounted to—

3s. 2·595d.	7s. 4·136d.
-------------	-------------

The metals, at the lead matt smelting, copper matt concentration process, and the slag smelting process, were contained in the mixture as follows :—

<i>At Halsbrücke.</i>	<i>Silver :</i>	<i>At Mulden.</i>
63·75 per cent in intermediate products.	84·11 per cent in intermediate products.	
36·25 „ in ore and lead ore.	15·89 „ in ore and lead ore.	
	<i>Lead :</i>	
100 per cent in intermediate products.	100 per cent in intermediate products.	
	<i>Copper :</i>	
73·84 per cent in intermediate products.	93·32 per cent in intermediate products.	
26·16 „ in ores and flux ores.	6·68 „ in ores and flux ores.	

### Desilverising Matt by Lead Products and Copper.

The processes for this operation consist of smelting argentiferous copper matt with argentiferous black copper and lead products. The copper matt may be produced either from real copper ores by raw smelting, or by a repeated desilverising of cupriferous silver ores by means of lead. In these processes the liberated lead and the copper will together decompose the sulphide of silver contained in the matt. The extracted silver enters into combination with lead, and there result a matt richer in copper and poorer in silver, and a raw lead richer in silver. The copper also partly decomposes the sulphide of lead contained in the matt.\* When the black copper contains silver it is likewise extracted by the lead. When too much copper is added the whole will not enter into the matt, but part will combine with the lead; and if lead is not added in excess to the sulphide of silver, the copper will alloy with the silver, and also form argentiferous copper matt.

If all the circumstances are suitable, these processes will effect a more perfect extraction of the silver, and a production of purer black copper than is possible by a simple liquation of black copper; but they are amongst the most complicated of metallurgical operations. The desilverised refined copper always retains a considerable amount of silver; for instance, copper of 5 ozs. retains about  $\frac{1}{2}$  oz. of silver, equal to 10 per

\* KARSTEN'S Metallurgie, v., 476. ERDMANN'S Journal für pr. Chem., ii., 133.



cent of the whole silver originally present, and there is also a considerable loss of lead and copper. On account of their disadvantages these processes are sometimes replaced by a process in the wet way (treatment of copper by sulphuric acid).

**Smelting with Black Copper.**—This process was introduced into Upper Hungary, Nagybanya, by Schweitzer, in 1832, for the working of real auriferous silver ores, of argentiferous and auriferous pyrites, of argentiferous copper ores, and lead products containing a variable amount of gold and silver. Whether the application of this process is advantageous or not depends on the proportion of the matt to the black copper resulting from the smelting. If matt is present in excess, the extraction of the silver will be too incomplete; a deficiency of matt, on the other hand, will cause the copper to combine with the raw lead.

**Abdarr Process.**—This is a liquation process combined with raw smelting and fusion with lead. It allows a more perfect extraction of the silver, causes less loss of copper, and the refined copper produced is of a better quality than that resulting from the common liquation process. It resembles the copper liquation process in treating argentiferous matt with lead products and black copper.

This process is the most complicated of all metallurgical processes, and is only applicable to argentiferous copper ores, and not to cupriferous silver ores, which do not contain sufficient copper to collect the silver. The process is in use at Szalathna, in Siebenbürgen, and at Brixlegg,\* in Tyrol, for the working of copper ores associated with baryta, quartz, and calc spar.

### 3. Lead Process with Argentiferous Speiss (Regulus).

Argentiferous speiss resulting from lead, silver, and copper smelting processes, is desilverised by a fusion with lead, by amalgamation in the wet way, or by a treatment with solution of common salt or diluted sulphuric acid.

At Freiberg† lead and cupriferous speiss, resulting from

\* Oesterr. Ztschr., 1853, p. 221.

† PLATTNER and RICHTER's Vorlesungen, ii., 352. B. u. h. Ztg., 1864, p. 59.

the different smeltings of lead ore, lead and copper matts, as well as from the concentration processes of lead and copper matt, containing 0·4 to 0·5 per cent of silver and 2·5 per cent of nickel and cobalt, is roasted and smelted together with 50 per cent of lead hearth ends, 150 per cent of baryta slags from the copper matt concentration (*see* Copper), and 10 per cent of sulphate of baryta, for the production of raw lead, copper matt, and speiss poor in silver, and containing 12 or 13 per cent of nickel and cobalt. The speiss is then without any re-roasting desilverised 2 or 3 times by a treatment with lead products, slag from the cupelling process, and 10 per cent of sulphate of baryta, till at last a speiss results containing 0·03 lb. of silver, from 15 to 18 per cent of copper, and from 15 to 18 per cent of nickel. This speiss is further concentrated in a reverberatory furnace (*see* Nickel); efforts were made to desilverise the speiss after calcination in a reverberatory furnace by fusing and stirring it with  $1\frac{1}{2}$  times its weight of lead, when there resulted raw lead containing 0·02 lb. of silver, copper matt, and a speiss containing matt and 0·02 lb. of silver.

#### 4. Lead Process with Argentiferous Black Copper.

In this process the two following cases must be taken into consideration :—

*a.* Copper Rich in Silver may be cupelled directly with 16 times the quantity of lead, but, according to Wehrle,\* causing a loss of 12 per cent of lead and 1 per cent of silver, and therefore this mode is only applicable to copper rich in silver and in gold; it is also advisable to add the copper, in quantities not exceeding 6 per cent, to rich lead when cupelling it. The resulting litharge rich in copper, must be reduced, if possible, together with other argentiferous and cupriferous residues, and the resulting alloy liquated. This process is seldom used.

*b.* Black Copper poor in Silver is submitted to the liquation process. If such a copper is smelted together with lead in a certain proportion, a mixture is formed after

\* Oester. Ztschr., 1857, p. 281.

the cooling of the alloy, consisting of argentiferous lead, and a combination of about one part of lead and three parts of copper. Upon heating this alloy to the melting point of lead, the argentiferous lead flows out, and the less easily fusible alloy of lead and copper remains.

This process causes great loss of metal, and a large consumption of fuel and labour; and the desilverising is imperfect, and requires a number of operations to regain part of the valuable metals which remain in the intermediate products, thus rendering the completion of the process difficult.

According to Wehrle, the loss of silver in this process averages about 21 per cent. The process is abandoned in many places on account of these faults, and is replaced by processes conducted in the wet way, except in those localities where the ores are more impure, containing chiefly lead, antimony, and arsenic, which render the processes in the wet way inapplicable; these ores may be purified by employing a good deal of lead, thus producing a middling copper. But the processes by the wet way also have of late been used for the working of more impure ores and their products (Freiberg, Oker, Altenau).

According to Karsten,\* the cost of liquation per cwt. of black copper amounts to from 4 to 5 ozs. of silver, and, consequently, copper with less silver is unfit for this process; the limit in the Upper Hartz † is from  $2\frac{1}{4}$  to  $2\frac{3}{4}$  ozs. of silver, but it is somewhat modified according to the price of lead.

When the copper contains too much silver, the cost of liquation is also raised, as the process must then be repeated several times in order to extract the silver as much as possible.

The different manipulations of this process are as follows:—

**Reducing the Black Copper into Small Fragments.—**

This may be effected either by breaking up the copper after heating it, by means of crushing mills, or by heavy hammers,

\* KARSTEN'S *Archiv.*, I R., ix., 3. KARSTEN'S *Metallurgie*, v., 415, 421.

† KERL, *Oberharzer Hüttenprocesse*, 1860, p. 523.

or by melting it in a reverberatory furnace, and running it into moving water.

**Alloying the Black Copper with Lead.**—According to Karsten the lead and copper in the alloy from which the argentiferous lead is extracted, should be in the proportion of 11 of lead to 3 of copper, and Karsten also states that at least 15 or 16 lbs. of lead are required for each  $\frac{1}{2}$  oz. of silver contained in the metallic mixture; but these proportions are only approximate. In the Hartz, the experience of many years has proved that 100 parts of black copper, with from  $1\frac{1}{2}$  to  $2\frac{1}{2}$  ozs. of silver, are best fused with from 200 to 250 parts of lead.

If black copper is so poor in silver that, by fusing it with lead in the proportion of 11 to 3, the raw lead resulting from the subsequent liquation process does not contain  $\frac{1}{2}$  oz. of silver to every 15 or 16 lbs. of lead, this poor raw lead is frequently employed for fusion with another quantity of black copper, which then causes the production of raw lead, containing the stated amount of silver.

It is a fact that, when smelting argentiferous black copper with lead free from silver, the extraction of silver is more perfect than when using argentiferous lead. In the first case lead poor in silver will result, but also black copper more perfectly desilverised, as the lead retained in the latter is poorer in silver; a choice between the two methods must depend on whether the greater yield of silver in the first case will balance the greater loss of lead in the cupelling process.

The fusion of the argentiferous copper with the proper amount of lead is done in a low cupola furnace about  $5\frac{1}{2}$  feet high, and constructed like a channel furnace with open eye. This well-heated furnace is charged with a small quantity of lead, and afterwards with copper, then again with lead, and so on alternately, a double charge being always allowed to fuse together and flow out before a second double charge has time to fuse. Great care and skill are required of the smelter, in order that the determined proportions of lead and copper may smelt together and combine. The resulting alloy falls into an iron mould of the required form, which is

that of a disc 18 inches in diameter, and 3 to 3½ inches thick; these are rapidly cooled by throwing upon them water, with some loam mixed with it, and they are taken out of the mould by means of a hook which has been put in them before solidifying.

**The Liquefaction Process.**—As before stated there results from the smelting of argentiferous black copper with lead, an alloy of copper, lead, and silver, homogeneous when in a liquid state, but if this alloy is suddenly chilled, which may be done by throwing water upon it, a mechanical mixture will be formed, consisting of argentiferous lead, and an alloy containing about 1 part of lead and 3 parts of copper, with more silver than the original black copper contained. The separation is chiefly effected according to the specific gravity, and therefore the argentiferous lead will be found at the bottom. If this mixture is now heated in a suitable apparatus to the melting point of lead, the argentiferous lead (raw lead) will flow out from the disc, and the copper alloy (spongy copper) will remain, containing about 3 parts of Cu and 1 part of Pb (10 to 25 per cent), and from 0.03 to 0.16 per cent of silver.

FIG. 66.

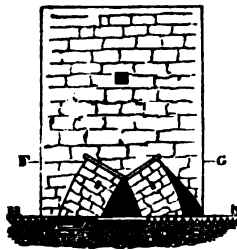

FIG. 67.

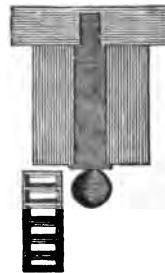
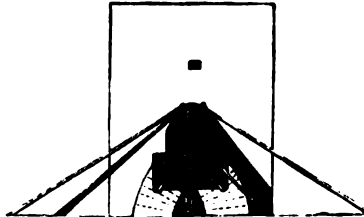

FIG. 68.



Figs. 66, 67, and 68 show the furnace employed for liquation in one of the principal smelting works of the Hartz.\* Fig. 68 shows the working area charged with the liquation cakes and charcoal, supported by sheets of wrought iron, being a representation of the process in action. Fig. 67 is the plan across the line F G of Fig. 66.

From 8 to 16 discs are usually placed in the liquation furnace. The operation lasts 3 or 4 hours, in which time about  $1\frac{1}{2}$  cwts. of charcoal are consumed. The cakes are covered with burning charcoal, supported as before stated by the iron plates. The argentiferous lead flows off towards the basin in front of the furnace, whence it is ladled out into moulds set alongside of each other (*see* Fig. 67). It is usually added to the process of cupelling.

The spongy copper is submitted to—

**The Process of Sweating.**—This process aims at the removal of a still greater quantity of the argentiferous lead from the copper. The furnace is so arranged that the spongy copper may be piled beneath an arch, like that of a reverberatory furnace, and above several long apertures as in the liquation furnace, Fig. 66. By this arrangement they receive a strong heat, and at the same time a brisk current of air is passed over them. The lead coming to the surface is immediately oxidised, fuses, and falls into the channels below, while the unfused copper remains in its place; it is purified upon a German hearth (*vide* chapter, Copper). The oxidised products obtained by the process are reduced in a cupola furnace, and cupelled for the silver they contain.

#### EXTRACTION OF SILVER FROM RAW LEAD.

Up to the year 1833 one of the oldest metallurgical processes was used for the separation of silver from lead, namely, the cupelling process, an oxidising smelting, oxidising the lead, and removing it as litharge from the silver, which has very little affinity to oxygen. The litharge is then submitted to a reducing smelting in order to transform it into lead. As this process is expensive and causes great loss of metal, it is only profitable when the raw lead does not contain too little

\* URE'S Dictionary of Arts, &c., i., p. 886.

silver; the least quantity of silver admissible depends on local circumstances, chiefly the prices of material and labour. Lead containing 0·06 to 0·08 of silver may sometimes be employed, but as a general rule, less than 0·12 per cent is not admissible.

As many English lead ores\* contain not more than 0·03 to 0·05 per cent† of silver, Mr. Hugh Lee Pattinson,‡ of Newcastle, invented a method by which the silver contained in poor leads (0·009 per cent) might be so far concentrated that a sufficiently rich raw lead, and also marketable lead poor in silver, could be obtained. This process is the most valuable addition to the metallurgy of lead and silver which has been introduced during the present century. It was invented in 1829, and in a very few years gave new life to the lead and silver industry of the country. By decreasing the cost of separating the two metals, this process makes it possible to obtain an annual quantity of 200,000 ounces of silver, which was formerly thrown away. Even in 1836 the process was brought to such perfection that by its use the cost of separating silver and lead was decreased to one-third the sum required to treat the argentiferous lead by the old method; so that lead containing but 8-100,000th, or about 3 ozs. to the ton, could be subjected to it with profit, while experiments showed that much commercial lead held at that period five times this amount of silver.

According to Fallize,|| in Belgian works in which Pattinson's process is used it pays for extracting the silver from lead if the silver only amounts to 0·02 lb. in 1 cwt. of lead, and if the cost for desilverising does not exceed £1 13s. 5d. per ton. In England§ the amount of silver in galena is only paid for when the galena contains 83 per cent of lead, and more than 5 ozs. of silver per ton.

Pattinson's process has come into general use, and is also

\* B. u. h. Ztg., 1862, p. 297, 412.

† 1 ounce per ton = 0·03 per cent.

‡ *Annales des Mines*, 1836, x., 381. ERDMANN'S *Journ. f. pr. Ch.*, x., 321. DINGLER'S *Polyt. Journ.*, Bd. 65, p. 386.

|| B. u. h. Ztg., 1860, p. 359.

§ *Ibid.*, 1858, p. 364.

employed for raw lead, rich enough by itself, and for other reasons which will be mentioned later.

Parke's method of desilverising lead by means of zinc has, in most cases, been abandoned.

### Pattinson's Process.

This process is based upon the fact that when argentiferous lead is melted in a cast-iron pan, and allowed to cool gradually and equally, an immense number of small crystals separate from the mass; these crystals are much poorer in silver than the original alloy, while the fluid surrounding them contains most of the silver. The crystals are octahedral, united by one edge, and are of small size. The smaller they are, the richer the raw lead becomes, but they then form smaller masses, and are more difficult to separate from the liquid portion.

As the lead becomes purer, the crystals take a grey colour, and are more inclined to deaden. Larger and looser crystals are formed, and as they originate on the surface they sink more quickly to the bottom, as is the case in the enriching pans where all the impurities are concentrated.

A complete separation of the silver and lead is impossible, as the crystals always mechanically retain some of the argentiferous liquid metal; this is also the reason the crystals formed at the commencement of the process are the poorest in silver, and grow richer as the silver becomes concentrated in the fluid. In Freiberg experiments have been made by taking from 10 to 180 cwts. of crystals from lead containing 0.0250 per cent of silver, and by ascertaining their contents of silver. According to Stetefeldt, the following results were obtained:—

1 cwt. contained 0.0080 per cent.			
10	„	0.0085	„
20	„	0.0090	„
30	„	0.0095	„
40	„	0.0105	„
50	„	0.0110	„
60	„	0.0115	„
70	„	0.0120	„
80	„	0.0120	„



90 cwt. contained 0·0125 per cent.

100	„	0·0125	„
110	„	0·0130	„
130	„	0·0145	„
155	„	0·0205	„
180	„	0·0295	„

Therefore the amount of silver in the crystals stands in the following proportions to the average amount of 0·0225 per cent:—

1 cwt.	=	1 : 2·81
50 „	=	1 : 2·04
100 „	=	1 : 1·80
130 „	=	1 : 1·55
155 „	=	1 : 1·09
180 „	=	1 : 0·77

This shows that from one charge of 10 tons, the first  $6\frac{1}{2}$  tons of crystals contain 0·0114, the next  $2\frac{1}{2}$  tons, 0·026, and the 1 ton of liquid metal, 0·072 per cent of silver.

By a repetition of the crystallisation in a row of pans it is possible with the crystals, as well as with the remaining liquid, to carry on the desilverising to an extent only limited by economical considerations, while the enriching can only be done to a certain degree (according to the experiments at Freiberg,\* to not more than  $2\frac{1}{4}$  per cent of silver). The nearer this limit is approached, the later and more slowly the crystallisation will take place. The whole liquid mass shows an inclination to solidify, and the crystals possess nearly the same amount of silver as the remaining liquid. By a number of crystallisations the raw lead is gradually separated into a small part rich in silver (rich lead), and a larger portion poor in silver (poor lead). For the same reason the rich lead is seldom enriched beyond 1·7 per cent, whilst the extraction from the poor lead may be carried on till it contains not more than 0·001 per cent of silver (Tarnowitz, Altenau).

As already proved by Berthier and Berzelius,† the melting point of lead is lowered when the lead is alloyed with silver, provided the amount of silver does not exceed a certain

\* Freiburger Jahrbuch, 1862, p. 185. B. u. h. Ztg., 1862, pp. 251, 328.

† B. u. h. Ztg., 1860, p. 136.

limit. This alloy dissolves as a chemical combination, in an excess of lead, and the lead being the more difficult to fuse, crystallises upon cooling to a certain temperature, whilst the more easily fusible part, rich in silver, remains liquid. But if the amount of silver exceeds a certain proportion, for instance, 1 part of silver to 3 or even to 1 part of lead, the resulting alloy is more difficult to fuse than pure lead, and the result of the process will be as shown by the experiments at Freiberg.

In the division of the lead charge into crystals and liquid, practice has evolved two distinct systems—the *low system*\* by which as much as  $\frac{2}{3}$ ths of the contents of the pan are dipped out at each fusion as crystallised lead, and but  $\frac{1}{3}$ th is allowed to remain,—and the *high system*, in which as little as  $\frac{1}{3}$ rds of the lead are strained out as crystallised lead, the remaining  $\frac{2}{3}$ rd being allowed to run back into the pan.

The *low system* allows a rapid concentration of the silver, and may be chiefly applied with profit to the varieties of lead containing little silver, which are at the same time as pure as possible; otherwise the impurities cannot sufficiently be separated on account of the smaller number of pans in which a purification by the formation of dross takes place. This system requires few pans (from 3 to 6), as all the lead is not under operation the whole time, but part of the crystals with a moderate amount of silver are laid aside and kept till a full charge has collected. When using rich raw lead in this way, many different sorts of lead with varying amounts of silver had to be kept in store, causing the process to be less under control, and increasing its complexity.

Therefore for richer and less pure lead, the *high system* is used, in which the whole quantity of lead under treatment is always kept in the pans. It allows a more accurate and continuous operation, and works larger quantities in a certain time; it also produces pure lead quickest, but the number of pans (up to 15) must be the larger the more silver (up to 0.45 per cent) the lead under treatment contains.

In English smelting works, where raw leads containing

\* B. u. h. Ztg., 1858, p. 247.

very variable amounts of silver are bought, several systems are combined in order to extract the silver in the quickest way possible; sometimes also, if uniformly rich leads are worked, several systems are in vogue at the same time; for instance, from the charging pan upwards the high system is used, whilst downwards another system is adopted (sometimes by thirds), varying at the same time the charges in the pan.

In order to desilverise and enrich the lead uniformly, it is necessary to keep in each pan a constant amount of silver in the lead; this may be done by a careful observation of the process, and a continual assay of the contents in the pan. If irregularities have taken place they may be corrected by a judicious operating, by a partial charging of the pan, by an addition of lead with a corresponding amount of silver, &c.

Stetefeldt\* has endeavoured to find out a mathematical rule for the increase and decrease of silver in lead at the different crystallisations, but the mechanical difficulties of the process have prevented this being carried out with any success. It must be generally supposed that on the high system the crystals strained off contain about half as much, and the liquid twice as much silver as the original alloy. This proportion is more constant in the desilvering pan than in those for enriching; for instance, at Altenau the amount of silver always decreases by 0.005 lb., beginning at the 8th pan.

Amount of silver in the 8th pan	=	0.045	to	0.05	lb.
"                  9th "	=	0.025	"	0.03	"
"                 10th "	=	0.015	"	0.018	"
"                 11th "	=	0.0075	"	0.0088	"
"                 12th "	=	0.0044	"	0.005	"
"                 13th "	=	0.0022	"	0.003	"

That system is most economical in practice which requires the fewest pans to be dipped from for obtaining a sufficiently poor lead. In Freiberg another system is preferred in this respect to that by thirds (high system), which at the same time forms intermediate crystals. The same system has been used in England before. It divides the

\* B. u. h. Ztg., 1863, pp. 64, 69, 77.

charge of a pan into more than two parts (for instance, into three parts) in such way that from a charge of 10 tons the first  $6\frac{1}{2}$  tons of crystals are dipped out in the usual manner, and afterwards  $2\frac{1}{2}$  tons of intermediate crystals, whilst 1 ton of liquid remains. The amount of silver contained in the single pans remains constantly the same; but as it is more advantageously divided, fewer dippings out are required, costing less; on the other hand, the process becomes more complicated.

The intermediate crystals now contain either as much silver as the alloy, or they have a larger, or a smaller amount; the medium case only is of interest in practice.

Whichever system is employed, it is always necessary to bring the row of pans (*battery*) to the normal or lowest state by a judicious charging, and by crystallising different quantities of lead from one pan to another, &c. This normal state is obtained if, at a certain charge and a constant amount of silver in each pan, rich lead and poor lead result regularly from the battery.

The following conditions have an essential influence upon the process:—

1. **The proper Management of the Temperature.**—If it is too high, an insufficient formation of crystals will take place, and if too low, the mass will begin to chill almost uniformly, not allowing a sufficient separation.

2. **The Amount of the Charge.**—The charge must amount to at least from  $2\frac{1}{2}$  to 5 tons, otherwise the transformation from the liquid to the crystalline state takes place too quickly, without leaving sufficient time for dipping out the crystals. In England pans for charges of from 6 to 10 tons are used; the charges at the Hartz are from  $11\frac{1}{4}$  to  $12\frac{1}{2}$  tons; at Freiberg, 10 tons; at Tarnowitz, 12 tons, &c.

3. **The Amount of Silver contained in the Charge** is chiefly influential upon the number of pans required for a sufficient extraction, upon the choice of the charging pan, and on the number of crystallisations necessary.

Pattinson invented his process chiefly for enriching poor leads (0.01 to 0.04 per cent), and for this purpose the process

is most advantageous, as when using the low system the required concentration of the silver is obtained by a few pans and a small number of crystallisations. The larger the amount of silver contained in the lead, the more the time, labour, materials, and number of pans, must be increased for a sufficient extraction. But the process has also been used for richer leads (0·12 to 0·45 per cent of silver) in many smelting works, and has shown the following advantages over the cupelling process :—

*a.* As Pattinson's process is carried out at a low temperature, the loss of lead and also, in most cases, of silver, is less than that occasioned by the cupelling process, and the litharge reduction process. The loss of lead by Pattinson's process, when using the purer kinds of lead, amounts to from 1·5 to 3 per cent, and when using impure leads, 4 to 5 per cent; but in the cupelling and litharge reducing process this loss amounts to from 8 to 12 per cent. The loss of lead in Pattinson's process is caused partly mechanically, but chiefly by the formation of dross upon the surface of the lead. The loss of silver is caused partly by the loss of lead, and partly by the amount of silver which is retained in the poor lead.

According to the experiments made at the Upper Hartz,\* the cost for treating highly argentiferous lead by Pattinson's process is not less than that for cupelling such lead; indeed, it sometimes costs more, and the work is also carried on more slowly, but the expense is balanced to some extent by a greater yield, and the greater purity of the lead. In these works at the Hartz, Pattinson's process with raw lead containing 0·18 to 0·20 per cent of silver may be carried on with advantage, if the price of lead is not below 12s. per cwt.

*b.* A purer lead is obtained, which fetches a higher price in the market.

*c.* Less skilful workmen are needed, but they must be strong and attentive.

4. **The Purity of the Raw Lead.**—The purer it is, the quicker and the more perfectly the desilverising succeeds,

\* FEHRES, B. u. h. Ztg., 1864.

and the purer will be the resulting poor lead. The presence of copper, antimony, and arsenic impedes the formation of the crystals, the liquid portion is retained more copiously by the crystals, necessitating more crystallisations, and the poor lead always retains some amount of the above-mentioned impurities, although the greater part of them is concentrated in the liquid. A small amount of nickel\* in the raw lead also becomes concentrated in the liquid, but it is likewise found in the crystals if the amount present exceeds 10 ozs. to the ton; its behaviour is similar to that of copper. Arsenic enters in large proportion into the crystals, and also copper if present in considerable quantities.

When using purer lead, a simple skimming off the dross will be sufficient, but if the lead is impure, it may require to be stirred with a wooden pole (Upper Hartz), or refined† in reverberatory furnaces (England, Stolberg, Freiberg).

5. **The Number of Workmen.**—More workmen are required than for the cupelling and refining processes of litharge; the crystals are either dipped out from one or both sides of a pan. The latter plan requires two workmen on each side, and is preferable, as the crystals are more quickly removed, and the process may be finished before the cooling has proceeded too far.

The following are the products of Pattinson's process:—

1. **Rich Lead**, usually containing from 0·5 to 1·5 per cent of silver.
2. **Poor or Commercial Lead**, containing from 0·001 to 0·003 per cent of silver, and usually of great purity.
3. **Dross‡** (scum), containing greater or smaller amounts of metal, formed by oxidation of the lead and foreign substances; it is also mechanically mixed with lead.

The first metallic dross (*Schlicker*) obtained from the smelting of the lead in the charging pan (Upper Hartz), or in a refining furnace (Freiberg), is either cupelled directly (Upper Hartz), or submitted to a liquation process (Frei-

\* BAKER, in *Berg. und hüttenm. Zeitung*, 1865, p. 188.

† B. u. h. Ztg., 1862, p. 297.

‡ Ibid., 1858, p. 363; 1862, p. 300.

berg); the rich dross from oxidation, as also the dross obtained by poling the lead, are reduced.

The rich and poor dross from the pans formed by oxidation (*Bleidreck*) is seldom cupelled directly, but is usually reduced either in reverberatory furnaces (England, Stolberg, Tarnowitz, &c.,) or in cupola furnaces (Upper Hartz); the resulting rich lead is either, according to the amount of silver and antimony it contains, again treated by Pattinson's process, and in that case previously refined (England), or cupelled directly (Tarnowitz, Upper Hartz); the resulting reduced leads are then either re-treated by Pattinson's process, or are sold as such.

By reducing the dross in reverberatory furnaces a purer lead results than by reducing it in cupola furnaces. The loss of metal is about the same in both cases, but reduction in cupola furnaces is cheaper, and produces larger quantities. For instance, at Altenau (Hartz), in cupola furnaces, in 12 hours,  $6\frac{1}{4}$  to  $6\frac{1}{2}$  tons of lead are produced from such dross, consuming 180 cubic feet of charcoal; and in England, in reverberatory furnaces, from  $5\frac{1}{2}$  to 6 tons of lead are produced in the same time, with a consumption of from 8 to 10 cwts. of coal.

#### APPARATUS FOR PATTINSON'S PROCESS.\*

These are chiefly:—

1. **Pattinson's Pans**—Figs. 69 and 70 represent a plan and elevation of a set of Pattinson's pans. A, is the market pan from which the desilverised lead is ladled out. B, C, D, E, F, G, H, and I, are the working pans, while A', B', C', D', E', F', G', H', and I', are the respective fire-places. a, a, a, a, are temper pans employed for heating the ladles when they have become too much reduced in temperature. These pans are not required when manual labour is employed.

The pans are larger or smaller according to the charge employed; they are usually from 5 to  $5\frac{1}{2}$  feet wide and from  $2\frac{1}{2}$  to  $2\frac{3}{4}$  feet deep, and from  $1\frac{1}{2}$  to 2 inches thick in iron, either uniformly as in England, or of an increasing thickness of  $1\frac{1}{2}$  to 2, or 2 to 3, inches from the edge to the bottom.

\* URE'S Dictionary of Arts, 1867, ii., p. 825.

FIG. 69.

FIG. 70.

[www.libtool.com.cn](http://www.libtool.com.cn)

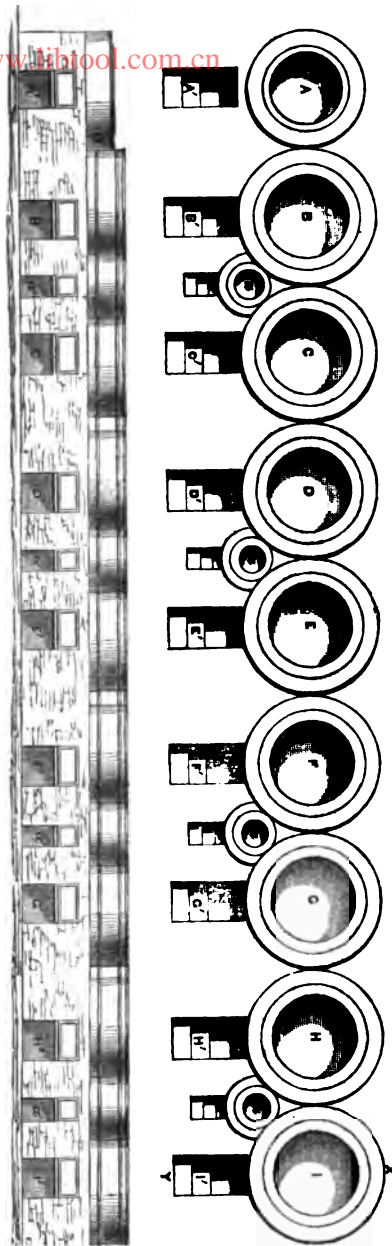



Figs. 71 and 72 are sections showing the manner of setting and the arrangement of the pans and flues. A, is the pan ; B, the main flue ; c, the ash-pit. The erection of nine 6-ton pans

FIG. 71.

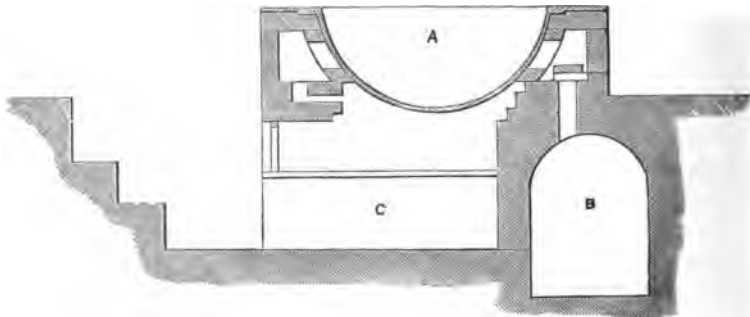

requires 15,000 common bricks, 10,000 fire-bricks, 160 feet of quarles, 80 fire-clay blocks, and 5 tons of fire-clay.

In some establishments cranes are made use of for lifting the ladle employed in the removal of the crystals ; they are found to be advantageous.

FIG. 72.

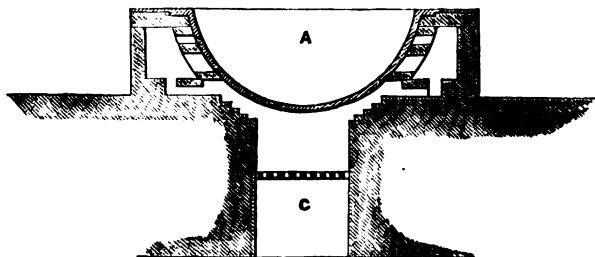

At Enthoven's smelting works at Rotherhithe, near London, Worsley\* has tried to tap off the liquid from the crystals by a sieve-like apparatus at the bottom of pans.

According to Fehres,† the French Pattinson's apparatus is successfully employed at Holzappel. It is furnished with a stirrer for keeping a uniform temperature in the whole mass of lead, and at the same time for pressing together the separated

\* B. u. h. Ztg., 1860, p. 493 ; 1862, p. 299. Berggeist, 1861, p. 290.

† B. u. h. Ztg., 1864, p. 4 (with drawings).

crystals, allowing the liquid to be tapped off when  $\frac{2}{3}$  or  $\frac{1}{2}$  of the contents of the pan are transformed into crystals.

The crystals are removed from the pans by long perforated ladles, from 16 to 19 inches in diameter, and 4 or 5 inches deep; they are made of strong iron plates; the holes are  $\frac{1}{2}$  inch wide, and stand  $\frac{3}{4}$  inch from each other.

2. **Furnaces for reducing the Dross from the Pans.**— Reverberatory furnaces are more suitable for this than cupola furnaces, as they allow the low temperature required for the reduction of oxide of lead to be more evenly sustained, and as they reduce less impurities. On the other hand, reverberatory furnaces are more expensive than cupola furnaces if the production is not large. Cupola furnaces are used in the Upper Hartz, whilst reverberatory furnaces are employed in England, Stolberg, and Tarnowitz. The furnaces at Tarnowitz (Figs. 73 and 74) may be recommended for the purpose on account of their simplicity and the cheapness of their construction and repairs.

FIG. 73.

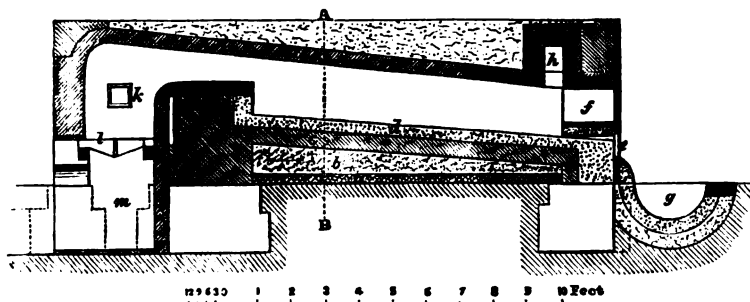
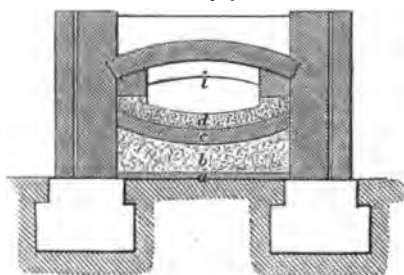

FIG. 74.



Section across A B.

*a*, is a sole three inches thick; *b*, sand; *c*, a layer of bricks; *d*, the hearth, nine inches thick, of a trough-like form, made of clay and small coal, and inclined towards the tapping hole *e*; *f*, the working door; *g*, the outer basin; *h*, a flue in the arched roof leading to a condensation channel which is connected with a chimney 150 feet high; *i*, the fire-bridge; *k*, charging door for the fuel; *l*, the grate, and *m*, the ash pit.

#### A. High (Thirds) System of Crystallisation.

*Manipulation of the Process*.—If the battery, consisting of from 8 to 14 pans, according to the amount of silver contained in the raw lead, is in a normal state (page 256), the regular operation begins. The charging pan is first washed with lime water, and then heated; the third pan is selected if the raw lead contains 0.17 per cent of silver or more, and the seventh if the raw lead is poor, and contains only 0.02 per cent of silver. The full charge (from 9 to 12½ tons) is then added and melted in about 6 or 8 hours, the dross which accumulates on the surface is skimmed off for ¼ or ½ of an hour, and, if necessary for its purification, the lead is stirred for 1 or 2 hours with a wooden pole, and the resulting dross removed by means of a perforated ladle: all this time the lead is kept at a red heat. The metallic bath is then allowed to cool for ¼ or ½ hour; the fire being withdrawn, the cooling is assisted by a frequent stirring, and by carefully throwing water upon the surface of the lead. This must be done with the utmost caution, since the water may become so entangled in the fused lead that the sudden formation of steam will cause explosions, dangerous to the men employed, and leading to a loss of metal. At Holzappel the surface of the lead is covered with small lumps of charcoal previous to adding water. The mass begins to cool at the surface and along the sides of the pan, and the crusts thus formed are carefully detached by means of a bar, and thrown back into the fluid. Fluid lead is also poured upon the border of the pan, and if chilled is thrown back, the cooling being thus regulated.

The formation of crystals takes place as soon as the cooling

has reached a certain point; the surface becomes uneven, the mass pasty, and when crystals have been formed in sufficient quantity, then begins the dipping out of two-thirds of the mass in crystals into the heated pan next on the left hand. A ladleful is raised above the surface, it is allowed to drain a few moments, assisted by a shaking of the ladle, and is thrown into the neighbouring pan; the ladle is then re-warmed, cleaned, and the process repeated.

In some English smelting works a larger ladle is used; when filled with crystals the ladle is slowly lifted out of the metal bath by means of a movable pulley, and, hanging on a crane fixed between two pans, is brought into a horizontal position, when the draining of the fluid is assisted by blows with a hammer upon the handle of the ladle. The ladle is then moved over the neighbouring pan by means of the crane, and discharged (Par, in Cornwall). In other works the ladle is only lifted by means of a pulley, shaken by hand for draining, and removed to the neighbouring pan by means of guide bars and by hand (Panther Lead Works near Bristol, John Millican's Smelting Works, Nenthead, near Alston), or the ladle is suspended by a chain used for its removal (Gallongate Lead Works in St. Anthony, near Newcastle-upon-Tyne).

This crystallisation is finished in about two hours, and the remaining enriched liquid, one-third of the original mass, is then converted into a pasty state by throwing water upon it for about a quarter of an hour; it is then strained out into the next pan to the right. If the battery is in a normal state more pans are furnished with the suitable charges, so that from one to three crystallisations may be going on at the same time if enough workmen are to be had. One-third of liquid lead containing the same amount of silver as the raw lead is put into the charging pan, together with two-thirds of fresh raw lead, and the process goes on again, so that gradually the enriching pans obtain the full charge for crystallisation. In this way poor as well as rich lead is regularly produced by the battery.

If the raw lead which is added has not been previously refined it is also stirred with wooden poles in the next pans

for poor lead on the left-hand side, after they have been filled up.

The resulting scum, poor and rich dross, are kept and worked separately.

The operations of Pattinson's process will be explained by the following table, which has been drawn up for poor lead :—

*Table for Poor Lead.*

Charging 10 tons of lead with 0.02 per cent of silver into the 7th pan, the process will proceed as follows. The number 3 in the table is equal to 200, 2 = 130, and 1 = 70 cwts. :—

*Pans.*

1	2	3	4	5	6	7	8	9	10	11	12	13	14
						3 1 2*	3 2 1*						
					3 1 2*	3 2 1	3 2 1						
				3 1 2*	3 2 1	3 2 1	3 2 1						
			3 1 2*	3 2 1	3 2 1	3 2 1	3 2 1						
		3 1 2*	3 2 1	3 2 1	3 2 1	3 2 1	3 2 1						
	3 1 2*	3 2 1	3 2 1	3 2 1	3 2 1	3 2 1	3 2 1						
1	3 1 2*	3 2 1	3 2 1	3 2 1	3 2 1	3 2 1	3 2 1						
		3		3		3		3		3		3	2

The marks  $\wedge$ ,  $\nabla$  indicate how much of the charge is dipped out in crystals and put into the pan on the right, and how much liquid is ladled into the pan on the left ; therefore the first row shows that from the charging pan No. 7,

one-third of the charge has been ladled into pan No. 6, and two-thirds into No. 8.

The resulting rich lead in the first pan contains at least 1·5 per cent of silver, and the poor lead in the 14th pan 0·002 per cent. The lead used for completing the charges of the pans is marked in the table with \*; it must be of nearly the same richness as the lead in the pans.

**Illustrations of the High System of Working without Intermediate Crystals.**

*At the Upper Hartz.*—At Altenau, charges of raw lead with from 0·18 to 0·20 per cent of silver, weighing 11¼ tons, are worked in batteries of 13 pans. One pan weighs from 2¼ to 3 tons, and is 5 feet 6½ inches wide, and 2 feet 10 inches deep, the thickness of the iron at the bottom is 3 inches, and on the sides 2 inches. The last pan for poor lead is somewhat smaller. The third pan is used as the charging pan. After the first dross is skimmed off from the melted lead, it is stirred with a wooden pole for two hours, and the stirring is also continued in the fourth pan. The dipping out of the crystals from one pan takes three or four hours; the resulting poor lead contains from 0·0025 to 0·003 per cent of silver, and the rich lead from 0·7 to 0·75 per cent. In the normal state of the battery, the percentage of silver in the full pans was as follows:—

	I.	II.	III.	IV.	V.	VI.	VII.	VIII.	IX.	X.	XI.	XII.	XIII.
1.	0·58	0·37	0·25	0·19	0·15	0·10	0·07	0·05	0·026	0·0117	0·0087	0·0049	0·0038
2.	0·33	0·27	0·19	0·13	0·11	0·09	0·06	0·045	0·02	0·0115	0·0085	0·0063	0·0038
	1. Raw lead from schlich.						2. Raw lead from dross.						

In the year 1861-2 were produced from 5 tons of raw lead, 50·30 per cent of refined lead, 11·22 per cent of crystallisation lead, 18·74 cwts. of rich lead, 15·59 cwts. of skimmed lead, 4·17 cwts. of rich dross from the pans 1 to 4, 18 cwts. of poor lead from the pans 5 to 12, and 1·50 cwts. of poor scum from pan No. 13, consuming 1,200 bundles of wood, or 2 tons of coal. The loss of silver, according to the assay of the raw lead, amounted to 1·7 per cent, and the loss of lead to 3·24 per cent. By this process one workman can treat in 12 hours 6·31 cwts. of raw lead, producing 3 cwts.,

88 lbs. of poor lead. The cost of working 5 tons of raw lead is—

	£	s.	d.
For labour . . . .	2	8	11·5
,, materials . . . .	4	11	9·3
,, tools . . . .	0	1	8·2
Total . . . .	£7	1	0·5

When worked in cupelling and reducing furnaces the same quantity of raw lead occasions a loss of 9 per cent of lead, and costs £3 17s. 9d. ; and thus the higher yield of lead by the former process ( $5\frac{3}{4}$  per cent) has to balance the extra expense of £3 3s. 8d. This is exactly effected when the market price of lead is 11s. 3d. per cwt. As in the year named the average price was 17s. 5d., Pattinson's process allowed a saving of £1 15s. 6d. upon every 5 tons treated by it. Eight workmen work during the day, and eight during the night ; the 16 workmen are paid 6·24d. for each cwt. of poor lead they produce ; two assistant workmen are allowed for the day and night, each receiving 1s. 3d. for a shift of 12 hours. Those 16 men attend to 14 pans in 24 hours.

*At Munsterbusch,\** near Stolberg, the raw lead containing 0·02 per cent of silver is refined in reverberatory furnaces. About 13 tons are refined in 30 hours at a low red heat, air being admitted, and some powdered lime and small coal being thrown now and then upon the surface of the lead, the dross formed is skimmed off from time to time, and the purified lead is poured into moulds. The consumption of coal in 30 hours amounts to about 27 cubic feet.

The refined lead is submitted to Pattinson's process in batteries of 13 pans, arranged like those of the Upper Hartz, and the lead is charged according to the silver it contains, either in the 5th or the 6th pan, but mostly into the 6th. The loss of lead amounts to 3 or  $3\frac{1}{2}$  per cent, the lead is enriched up to 1 per cent, and  $2\frac{1}{2}$  tons of coal are consumed in 24 hours, during which time from 20 to 25 pans are dipped out. The charge of each pan is from 12 to  $12\frac{1}{2}$  tons. The cost

\* B. u. h. Ztg., 1858, p. 300.

for enriching 1 ton of lead originally containing 0·019 per cent of silver, up to an amount of 0·36 per cent of silver, is about 118 10d.

At Tarnowitz,\* the raw lead containing 0·0986 per cent of silver is treated in a battery of 14 pans, charging 12 tons in the fourth pan. It is enriched to 1·2 per cent, and the poor lead then contains only 0·001 per cent. On the 3rd of June, 1862, the single pans contained nearly the following amount of silver, in grammes per cwt. :—

I. 0·75 II. 0·44 III. 0·268 IV. 0·151 V. 0·0745 VI. 0·05 VII. 0·035  
VIII. 0·026 IX. 0·0145 X. 0·0076 XI. 0·0048 XII. 0·0028 XIII. 0·002  
XIV. 0·0010

This condition is sustained by a continual assaying and a careful superintending of the process, and also by adding the rich third of the fifth pan to the third pan, instead of the fourth, if the room in the pan will allow it. From 5 tons of raw lead were produced—

18·15 per cent of rich lead, containing 1·2 to 1·433 per cent of silver.

59·52 per cent of poor lead, containing 0·001 per cent of silver, and 11·375 specific gravity at 18°.

21·27 per cent of lead skimmed off.

Total : . 98·94 per cent.

The loss of lead by Pattinson's process and by the reduction of the dross skimmed off is 1·2 per cent, and the yield of silver is 1·2 per cent larger than that obtained by the cupellation assay. 5 tons of raw lead consume 21·7 cwts. of coal. 21 workmen assist at one battery, and they are paid 3·48d. per cwt. of poor lead produced; out of this payment they must keep three assistants, and pay sundry items for the weighing and marking of the lead, &c. 5 tons of commercial lead cost £1 7s. 6d. for labour, 6s. 7·9d. for coal; total, £1 14s. 1·9d. The cost for 1 cwt. of such a lead is therefore 4·2d.

The dross from the pans, containing 88 per cent of lead and 0·102 per cent of silver, is reduced in a reverberatory furnace, and the resulting raw lead again submitted to

\* B. u. h. Ztg., 1864, p. 317.



Pattinson's process. 5 tons of this dross yield 90.36 cwts. of raw lead, and 9.30 cwts. of reduction slag, containing 58 to 59 per cent of lead and 0.006 per cent of silver.

This slag is worked in cupola furnaces 16½ feet high, mixed with 7 per cent of iron, 53 per cent of iron refinery cinders, and 12 per cent of limestone, and yields about 54.5 per cent of raw lead, containing 0.015 per cent of silver, which is concentrated by cupellation.

A comparison of Pattinson's process with the process of cupelling and reducing formerly used, as far as regards the expense of producing five tons of commercial lead, may be drawn from the following table :—

*A. Cost of Pattinson's Process.*

	£	s.	d.
a. For labour . . . . .	1	7	6
b. „ fuel . . . . .	0	6	8
c. „ loss of lead (2.5 per cent) . . . . .	2	3	9
d. „ loss of silver (0.001 per cent) . . . . .	0	9	0
Total . . . . .	£4	6	11

Or per cwt. . . . . £0 0 10½

*B. Cost for Cupelling and Reducing, including Working up the Intermediate Products resulting from both Processes.*

	£	s.	d.
a. For labour and materials . . . . .	2	18	10
b. „ loss of lead (4 per cent) . . . . .	3	10	0
c. „ loss of silver . . . . .	1	17	6
Total . . . . .	£8	6	4

Or per cwt. . . . . £0 1 8

*At some English lead works,\** raw leads, sometimes not containing more than 3 ozs. of silver per ton, are treated according to the high system; they are first refined in reverberatory furnaces; the charges are from 6 to 10 tons, and the lead is

\* DINGLER'S *Polyt. Journ.*, Bd. 65, p. 386. TUNNER'S *Leobener Jahrb.*, 1852, p. 143. *B. u. h. Ztg.*, 1859, p. 433; 1862, p. 296. *Berggeist*, 1861, p. 338.

enriched up to from 160 to 600 ozs. per ton (0·48 to 1·8 per cent), the poor lead containing not more than from 15 to 7 dwts. of silver per ton (=0·0027 to 0·0015 per cent).

The cost of crystallising one ton of calcined Spanish lead is as follows :—

	s.	d.
Labour . . . . .	9	5·4
Coals, 4 cwts. . . . .	0	8·4
Repairs . . . . .	0	2·50
Total . . . . .	10	4·3

### Illustrations of the High System of Working with Intermediate Crystals.

*In England\** batteries of 9 pans are used for this system of crystallising lead containing about 10 ozs. of silver per ton. It is charged into one of the medium pans; 4 or 5-14ths of the crystals of the charge, containing about 5 ozs. of silver, are dipped out and put into the pan on the left, then 4 or 5-14ths of intermediate crystals containing 10 ozs. of silver are put on to the edge of the pan, and the last 3 or 4-14ths of liquid, containing 20 ozs. of silver, are put into the enriching pan on the right. After this the lead from the edge of the pan is put back into the charging pan, which is filled up again with fresh lead. The process is then continued in this way until the first two side pans are ready for dipping out, and in this manner the crystallisation is carried on till poor lead, containing  $\frac{1}{4}$  or  $\frac{1}{2}$  oz., and rich lead, containing from 200 to 400 ozs., result.

*At Halsbrucke, near Freiberg*, leads containing up to 0·60 per cent of silver are submitted to Pattinson's process in batteries of 14 pans and charges of 10 tons. In the high system as commonly adopted,  $6\frac{1}{2}$  tons of crystals and  $3\frac{1}{2}$  tons of liquid are dipped out; if forming intermediate crystals,  $6\frac{1}{2}$  tons of crystals,  $2\frac{1}{2}$  tons of intermediate crystals, and 1 ton of liquid are dipped out up to the 8th pan; from the other pans 7 tons of crystals, 2 tons of intermediate crystals, and 1 ton

\* TUNNER'S Leobener Jahrbuch, 1852, p. 143.

of liquid are taken. To prevent the state of the battery upwards from becoming too low, the intermediate crystals are not usually strained so much. The state of the battery downwards becomes poorer with intermediate crystals, the same as when adopting the common high system; this is shown by the following table:—

<i>With Intermediate Crystals.</i>		<i>Without Intermediate Crystals.</i>	
Per cent of Silver.		Per cent of Silver.	
I pan . . .	1'02—1'13	I pan . . .	1'00
2 „ . . .	0'63—0'71	2 „ . . .	0'67
3 „ . . .	0'45—0'49	3 „ . . .	0'47
4 „ . . .	0'29—0'34	4 „ . . .	0'34
5 „ . . .	0'21—0'23	5 „ . . .	0'24
6 „ . . .	0'16	6 „ . . .	0'16
7 „ . . .	0'094	7 „ . . .	0'115
8 „ . . .	0'056	8 „ . . .	0'08
9 „ . . .	0'032	9 „ . . .	0'055
10 „ . . .	0'018	10 „ . . .	0'036
11 „ . . .	0'0105	11 „ . . .	0'0275
12 „ . . .	0'006	12 „ . . .	0'0116
13 „ . . .	0'0035	13 „ . . .	0'0058
14 „ . . .	0'0015	14 „ . . .	0'0029

The proportion of alloy, intermediate crystals, and liquid is, for instance, 1 : 1'4 : 3; 2'25 : 2'6 : 7'2; 13'7 : 19 : 35'7.

The rich lead contains from 1'50 to 1'68 per cent of silver; the poor lead 0'003 to 0'0025 per cent.

The following experiments with 250 tons of lead containing 0'023 per cent of silver, comparing the effect of the high system with and without intermediate crystals, are of great interest:—

#### Five tons of lead consumed—

<i>With Intermediate Crystals.</i>	<i>Without Intermediate Crystals.</i>
12'06 cwts. slate coal.	16'19 cwts. slate coal.
0'88 „ cinders.	0'80 „ cinders.

#### Costing per cwt.—

1'135d. for fuel.	1'508d. for fuel.
0'677d. „ labour.	0'775d. „ labour.

The commercial lead was desilverised downwards to—

0'003 per cent.	0'0025 per cent.
-----------------	------------------

The raw lead became enriched up to—

0'185 per cent.	0'175 per cent.
-----------------	-----------------

### The charged lead yielded—

#### *With Intermediate Crystals.*

3400 cwts. commercial lead = 68  
per cent.  
301 cwts. rich lead = 6 per cent.  
1300 " intermediate products =  
26 per cent :—namely  
585 cwts. liquid.  
715 " lead scum.

#### *Without Intermediate Crystals.*

3120 cwts. commercial lead = 62·4  
per cent.  
300 cwts. rich lead = 6 per cent.  
1580 " intermediate products =  
32 per cent :—namely  
810 cwts. liquid.  
770 " dross.

### The yield of silver contained in the charge was—

55·6 lbs. = 48·3 per cent in rich  
lead.  
49·2 lbs. = 42·7 per cent in inter-  
mediate products :—namely  
25·1 lbs. liquid.  
14·1 " lead scum.  
10·2 " = 9·87 per cent in  
commercial products.

56·0 lbs. = 48·7 per cent in rich  
lead.  
54·7 lbs. = 47·6 per cent in inter-  
mediate products :—namely  
38·0 lbs. in the liquid.  
16·7 " in dross.  
7·8 " = 6·82 per cent in  
commercial products.

The expense of producing 1 cwt. of commercial and rich lead amounted in the former case to 2·44d.; in the latter case to 3·33d.

### B. Low System of Crystallisation.

The lead, after having been refined, if necessary, is smelted, skimmed off, and cooled, as in the high system.\* Then  $\frac{7}{8}$  of the contents of the pan are dipped out in crystals, and put into the next pan, but the remaining  $\frac{1}{8}$  of enriched lead is poured into moulds, and the silver it contains marked upon it. The  $\frac{7}{8}$  of crystals in the next pan are supplemented by an addition of  $\frac{1}{8}$  of lead containing the same amount of silver, and are divided again by dipping out respectively into  $\frac{7}{8}$  and  $\frac{1}{8}$ ; the latter being again poured into moulds. If lead containing different amounts of silver is at disposal, it is used for completing the  $\frac{7}{8}$  until the lead is sufficiently desilverised. On the other hand, the  $\frac{7}{8}$  are also ladled out, and the crystallisation of fresh lead is continued till a sufficient quantity is collected for charging several pans, each containing a correspondingly less amount of silver; the concentrated leads are again enriched when a sufficient quantity is collected.

The number of pans varies according to the amount of the production. Few pans, from 3 to 6, are used, and in this system the  $\frac{7}{8}$ , as well as the  $\frac{1}{8}$ , have to be ladled out

\* B. u. h. Ztg., 1858, p. 310.

repeatedly before poor and rich lead result (Bleiberg); or more pans are used, and the  $\frac{1}{3}$  always remain in the pans (Binsfeldhammer): the remaining  $\frac{1}{3}$  is about 3 times as rich as the dipped-out crystals.

### Illustrations of the Low System of Crystallisation.

1. *At Binsfeldhammer*, near Stolberg, 20 pans, each 2 tons in weight, are used; each two of them are attended by two workmen, and form a battery, *i.e.*, two pans are used for one operation. The charge of 9 tons of lead, containing on an average 0.05 per cent of silver, is quickly melted; a sample is taken from it for assay, the fire is lowered by covering with ashes, &c., the pan cooled, and the scum (Sb, Fe, Zn, &c.) is either skimmed off at once, or is put into the neighbouring pan, and removed when the lead has passed once or several times from one pan to the other. The dipping out of  $\frac{1}{3}$  in crystals, and the pouring of the  $\frac{1}{3}$  into moulds, is then effected as above described.

If, for instance, the original lead contained 0.1 per cent of silver, it will be found that the  $\frac{1}{3}$  contains about 0.3 per cent, and the  $\frac{1}{3}$  about 0.07 per cent. The crystallisation is carried on until the rich lead contains from 1 to 1.5 per cent of silver, and the poor lead 0.001 per cent.

2. *At Bleiberg\** only 3 pans are used, and from raw lead containing 0.019 per cent of silver, a rich lead containing 0.44 per cent, and a poor lead containing 0.0015 per cent of silver, are produced.

3. *At Commern* raw leads containing 0.4 oz. of silver per cwt. are submitted to Pattinson's process in a battery of 6 pans, and a rich lead containing 12 or 13 ozs. of silver per cwt. is produced.

### CUPELLING THE RAW LEAD.

The cupelling process, aiming at the extraction of silver from argentiferous lead, is performed by keeping the raw lead in a liquid state on the hearth of a reverberatory furnace, and admitting atmospheric air, when oxide of lead will

\* B. u. h. Ztg., 1858, p. 310, 345.

be formed; the oxide of lead collects on the periphery of the metallic bath, owing to the convex surface of the lead, which is therefore again exposed to the oxygen in its centre. If now the litharge is continually removed as it is formed, the silver will ultimately remain.

There are two distinct methods of cupellation in common use—the *German system* and the *English system*. In the German system the hearth is formed of marl, or other similar material; it is fixed, and of large dimensions, and the lead is often added all at once. In the English, the hearth is movable, and is carried upon a movable iron frame; it is made of bone ash, and its dimensions are comparatively small; the formation of the litharge is very rapid; and the lead, instead of being added all at once, is charged gradually, as the contents of the hearth are oxidised.

#### THE GERMAN SYSTEM OF CUPELLATION.

This process is carried on in different places with the following modifications:—

1. The charge of lead (from 3 to 17½ tons) is added all at once (Hartz, Przibram, Ems, Pontgibaud, Kongsberg), or it is added gradually (Freiberg, Kremnitz, Lohe, Holzappel, Tarnowitz, Vialas).

The latter plan possesses the following advantages:—There is a saving of fuel, as the heat is better economised on account of the longer operations; the loss of metal is less, as less firing is required, and the quantity of plumbiferous hearth—causing great loss by its reduction—is less in comparison to the litharge and cupelled lead produced.

On the other hand, the gradual charging has the disadvantage that the resulting litharge contains more impurities, also the conduct of the process is more difficult. This plan is fit therefore for very pure raw lead, or for impure lead in cases where the litharge is used for different smelting processes, or if the lead produced from it is afterwards refined.

2. In most cupelling furnaces bright silver, containing from 5 to 10 per cent of impurities, is produced; it is seldom refined in these furnaces (Hungary, Siebenbürgen, Mähren),

as a volatilisation of silver is likely to take place. The cupelling process is sometimes not carried on to the brightening point; the lead is only concentrated to a certain degree to the so-called black brightening\* (*poor or concentration cupelling*), it is tapped off by the opening for litharge, and cupelled up to the brightening point in a separate operation (*rich cupelling*), (Hungary, Joachimsthal, Holzappel, Tarnowitz). Only poor raw lead is submitted to this process,† giving a larger quantity of commercial litharge, poor in silver. If such poor lead is at once completely cupelled, the amount of resulting bright silver will be small, and the production of rich argentiferous litharge great. If these leads are concentrated, and the rich leads are cupelled, the production of rich litharge takes place only once. But in most cases Pattinson's process has done away with this concentration cupelling.

3. The usual fuel for the cupelling process on the Continent is wood (bundles of brush-wood); turf‡ or coal|| (Tarnowitz, Vialas, Müsen), is seldom used.

4. Experiments made at Kongsberg,§ in which hot blast was used, allowed a shortening of the process, as the formation of litharge was increased.

**Cupelling Furnaces.**—Those mostly used in Germany are represented in Figs. 75, 76, 77, 78. They exhibit the

FIG. 75.

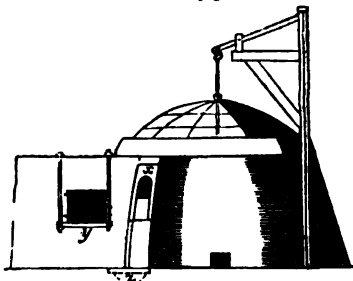

\* B. u. h. Ztg., 1855, p. 34.

† Rivor, *Traité de Métallurgie*, 1860, ii., 260.

‡ *Freiberger Jahrbuch*, 1840, p. 85.

|| *Freiberger Jahrbuch*, 1843, p. 76. ERDMANN'S *Journ. f. ök. Ch.*, v., 206; vi., 199, 381. Rivor, *Traité de Métallurgie*, 1860, ii., 599. B. u. h. Ztg., 1863, p. 92.

§ B. u. h. Ztg., 1855, p. 106; 1862, p. 437.

FIG. 76.

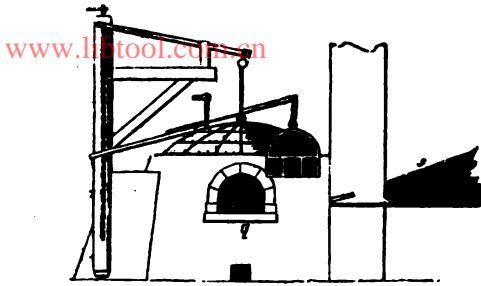

FIG. 77.

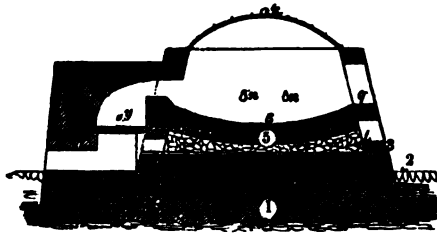
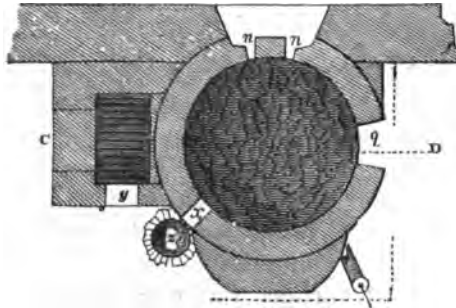

FIG. 78.



furnaces of the principal smelting works in the Hartz, and the following parts must be distinguished ; 1, (Fig. 77) is the masonry of the foundation ; 2, are flues for the escape of moisture ; 3, stone covers over the flues ; 4, bed of hard rammed scoriæ ; 5, bricks set on end, to form the permanent area of the furnace ; 6, the sole, formed of wood ashes, washed, dried, and beaten down ; k, dome of iron plate, movable by a crane, and susceptible of being lined



two inches thick with loam ; *n, n*, tuyeres, either for two bellows, or some other kind of blast machine ; if bellows are used, they have valves suspended before the orifices to break and spread the blast ; *g*, door for introducing the charge of lead into the furnace ; *s* (Fig. 76), two bellows, like those of a smith's forge ; *y*, door of the fire-place, through which billets of wood are thrown on to the grate ; *x*, small aperture or door, for giving egress to the frothy scum of the cupellation, and the litharge ; *z*, safety basin, usually covered with a stone slab, over which the litharge falls ; the basin is left open to receive the rich lead in case of accident.

Other cupelling furnaces will be described in course of the description of the cupellation process.

### Manipulations of the Cupelling Process.

In this process the following periods may be observed :—

**The Formation of the Hearth.**—The mass supporting the lead which is to cover the hearth of refractory bricks must be of the following nature :—

- a.* It must not contain substances having a reducing action upon the oxide of lead.
- b.* It must not alter in any way under the influence of the heat.
- c.* It must be able to absorb some oxide of lead, without forming a chemical combination with it.

Suitable materials are washed wood ashes (usually with an addition of burned lime), and marl. Marl is now almost universally used, as best fulfilling the above-named conditions, and it is also cheaper than wood ashes.

The marl is pounded and sifted, and is, while still in a moist condition, beaten by appropriate tools into the desired shape, that is, circular like the body of the furnace, and hollowed regularly, like a large saucer, from the edges towards the middle. In the middle of the hearth a circular deepening is cut from 10 to 30 inches in diameter, and from  $\frac{1}{8}$  to  $\frac{1}{2}$  of an inch deep. The formation of a good hearth requires much practice and skill. If the hearth is too flat

the formation of litharge is retarded, but the metal brightens quicker than on a deeper hearth. Again, a deep hearth offers too small a surface of metal, and consequently the process is prolonged and more fuel is consumed; where the hearth is uneven some raw lead and litharge will remain, causing a loss of metal. The hearth must also be beaten so hard that no impression can be made upon it by the fingers. If it is too loose it will absorb too much oxide of lead and silver, and if it is too hard it will crack. Also, if too dry when beaten in, it will cause the formation of scales which allow the metal to soak in; and it must be sufficiently thick, for the metal not to penetrate it. In Freiberg the hearth is 8 inches thick in the middle, and 9 inches on the edges.

**The Charging of the Raw Lead** is done while the cap of the furnace is removed, and, as before mentioned, the whole quantity is added either at once or gradually. When it is added gradually only part of the raw lead is first charged, and the after-charging commences when the formation of litharge begins, and is effected either continuously in small quantities, or by adding the remaining raw lead all at once, putting it upon the edge of the hearth, from whence it will gradually melt.

In Freiberg the charged lead is covered with wood or glowing coals. Then the cap is fixed on the furnace.

**Melting the Lead** is conducted at a gradually rising temperature; it is a sort of liquation process, as the pure raw lead melts and the other less fusible substances swim on the surface of the metallic bath. This covering (*abzug*) consists partly of substances mechanically intermixed with the raw lead, and partly of lead, copper, zinc, antimony, arsenic, silver, &c., either in an oxidised or a sulphuretted state. As no blast is used during melting, the coating contains little oxide of lead, which accounts for its being difficult to fuse.

After this scum is removed a stronger fire is given, and the blast put on, then another scum is formed upon the surface of the metallic bath (*abstrich*). At first the scum is frothy, black, and of a shining metallic appearance, but at

the end of this period it becomes greyish and greenish-yellow and compact. It contains metallic and oxidised lead, besides all the easily oxidising metals which were originally in the raw lead (zinc, iron, bismuth, antimony, arsenic, &c.).\* While removing the abstrich, the temperature as well as the blast is increased in order to facilitate the scorification. The quantity of abstrich formed depends on the purity of the lead. As soon as the dark colour disappears, and the frothy consistence has changed into a tougher one, the zinc, iron, and copper are mostly removed, and the abstrich then consists chiefly of antimoniate of lead, of a greenish brown colour. In proportion as this separates, the yellow colour of the pure oxide of lead will appear, flowing thinner upon the sole of the smelting-house, and commencing to solidify as soon as it leaves the furnace. All this time the temperature and blast are somewhat lowered. Where it is intended to add rich silver ores it is done at this time (page 218).

**The Formation of Litharge.**—The litharge is allowed to run off by the small opening; its passage is aided by a hook, and the workman digs a gutter in the floor of the furnace to facilitate its escape.

When the antimony has not been removed by the abstrich the formation of litharge is rendered difficult, as lead does not oxidise sooner than antimony; and the antimony is only extracted by a long continued and moderate fire, its removal being only effected by volatilisation and scorification.

At this period of the formation of litharge the three following points are chiefly of importance:—

*a.* **Judicious Firing.**—The temperature is generally kept moderate during this period, to avoid as far as possible a volatilisation of lead and silver, and to prevent a waste of the fire-bridge and gutter, as otherwise the raw lead would flow out. If the temperature is low the process will proceed too slowly; the oxidised silver which has entered into the slightly fusible litharge comes less easily into contact with

\* ERDMANN, Journ. f. ök. Ch., i., 48, 63, 72. BERTHIER, Probirkunst, i., 328. DINGLER'S polyt. Journ., xxix., 139. POGGENDORF'S Ann., xv., 278. BODEMANN, KERL'S Probirkunst, p. 292. BERZELIUS, Jahrbuch, ix., 133. Ann. d. Mines, I, sér., viii., 903.

metallic lead, and cannot be reduced, therefore cupelling processes carried on at too low a temperature produce litharge rich in silver; and, besides, the litharge in the gutter is then not sufficiently urged forward by the blast, and does not flow out readily. When the temperature is too high great loss of silver and lead will take place, and as the litharge is very hot and in a high state of fusibility, a large portion of it will be imbibed by the hearth.

Towards and at the end of the process there appears in the circumference of the litharge a development of bubbles, caused by moisture and carbonic acid emitted from the hearth. In Holzappel this is avoided by a longer warming of the hearth.

As a general rule, the firing during the formation of litharge must be strong at the beginning, then lower, and stronger again towards the end, as the alloy becomes more difficult to fuse in proportion as more lead is extracted, and the space in the furnace becomes more open.

The temperature may be chiefly judged by the colour and the degree of fusibility of the litharge, and also by the amount of fume formed. If the temperature is too high a thick lead fume will show itself on the surface of the metal bath; the litharge runs rapidly into the gutter, and flows down to the floor of the smelting-house without chilling. If the temperature is too low the lead fume will almost disappear; the litharge gets dark in places, and chills before flowing out. If the temperature is right, enough fume will be formed to allow at least half of the hearth to be seen.

**b. A proper Pressure of the Blast.**—The pressure of the blast must be highest during the period of the formation of abstrich; it is lowest at the commencement of the formation of litharge, and is increased towards the end of this period, chiefly just before the brightening point.

The metal bath should be always surrounded by a brim of litharge from 1 to 1½ feet broad; if it is too large it will prevent the further oxidation of the lead, and if too small, the volatilisation of lead and silver will be greater, and lead is likely also to flow out together with the litharge. According

to Schreder,\* the melting point of litharge is  $981^{\circ}$ , whilst lead volatilises at a temperature a little higher than its melting point ( $322^{\circ}$ ). During the cupelling process a temperature of more than  $980^{\circ}$  must be kept up in order to retain the litharge in a liquid state, therefore as much as possible of the metal bath should be kept covered by litharge, so as to prevent too great a loss of lead.

The blast may be conducted in different directions by means of the movable valves suspended before the tuyeres. At the commencement of the formation of litharge the blast from both tuyeres is driven in opposite directions, and its direction is modified according to the state of the litharge. Towards the end of the process the blast should cross behind the gutter: occasionally only one tuyere is used.

**c. A proper Arrangement of the Gutter for Litharge.—**

If the gutter is too deep the raw lead will probably flow out with the litharge, and if too shallow, too much litharge collects upon the metal bath, preventing the action of the blast upon it, causing a loss of time, fuel, and lead, and the formation of too thick a hearth; in such case a second gutter is cut. On account of the different temperatures the gutter is formed on the side opposite to the tuyeres at the commencement of the process, and on the side of the fire-place at the end of the process.

The litharge is composed differently according to the periods at which it is produced. In this respect it may be thus classified:—

**a. The First Litharge.—**This litharge is cupriferous and very impure, and therefore unfit for selling or reducing, and is usually added to the original ore smelting process. This litharge is generally of a brown or green colour, owing to the presence of copper and iron. Rich leads, which have been treated by Pattinson's process, frequently give a ferruginous green litharge, the iron being probably derived from the pan. Copper and lead seem to have an equally strong affinity for oxygen, as there is a certain amount of copper, though a decreasing one, in litharge from the commencement to

\* B. u. h. Ztg., 1860, p. 432.

the end of the process. A certain quantity of suboxide of copper renders litharge thinner, but also more difficult to fuse. Berthier has observed that when melted together with lead, suboxide of copper will oxidise the lead in accordance with the general supposition that copper has less affinity for oxygen than lead.

These apparently paradoxical facts are founded on the following law :—When smelting one of the oxidisable, so-called ignoble, metals (such as lead) together with the oxide of another of these metals (oxide of copper), there will result at least a partial oxidation of the former, the relative quantity of the oxide formed depending on the relative quantity of the oxide employed, and also on the proportional degree in which the electro-positive metal stands to the oxide, and *vice versa*, the electro-negative oxide to the metal. Thus, oxide of copper will oxidise lead, and oxide of lead will oxidise copper, according to which of the oxides is present in excess.

*b. Poor Litharge.*—This has a yellow colour when flowing out of the furnace, and formed into a lump. To form a lump, the litharge is allowed to collect before the furnace on the floor of the smelting-house till it forms a thick mass of 1 or  $1\frac{1}{2}$  tons weight, when it is removed. If these lumps are allowed to cool slowly, they crack on all sides, showing inside the cracks a red, scaly, easily friable mass (*red litharge, gold litharge, commercial litharge*), while the quickly chilling crust retains its original colour and cohesion, forming pieces more or less thick (*yellow litharge, silver litharge*). Both have the same composition, and the reason of their different states of aggregation is, according to Fournet and Levol, that the liquid litharge absorbs oxygen in the cupelling furnace like silver, and lets the oxygen escape when cooling by the abundant cracks which form; the isomeric red modification of litharge is thus produced in a manner not yet understood. This case resembles the formation of vitreous and amorphous arsenious acid, red and yellow iodide of mercury, &c.

Impure litharge gives little or no red litharge when cooling, as the property of absorbing oxygen is probably absent. Impure litharge also requires a higher temperature to keep

it liquid, and will not form lumps, but runs out of the furnace upon the floor, where it quickly chills.

The red litharge is not so fit for reduction as for several technical applications, on account of its fine state of division. Yellow litharge is better adapted for reducing, owing to its greater cohesion.

The production of red litharge may be assisted by making the fluid litharge run into large iron pots resting upon wheels. It is then carried in larger masses into the fresh air, and allowed to cool in a draught. The fluid litharge is also made to run into a basin formed of marl close before the furnace. When the lumps collecting in it weigh a ton or more they are taken out when still in a pasty state, and allowed to cool in the draught of air (F. Wimmer, Vialas). This method also allows a separation of the liquid lead from litharge. On the Upper Hartz most red litharge is produced when several lumps are put together for cooling; the produce of red litharge is larger in winter than in summer.

If, on the contrary, the production of red litharge is to be avoided, lumps are not formed, but the litharge as it flows out of the furnace is divided into small portions, and water is poured over it; or the litharge is made to run over an inclined iron plate that it may chill quickly without forming lumps.

The lumps are usually pounded with a hammer and sifted, so as to separate pieces of yellow litharge and intermixed grains of lead.

Yellow litharge is prepared for commerce by grinding and washing.

*c. Last (rich) Litharge.*—Litharge containing 0.01 per cent of silver and upwards is called rich, and is produced towards the end of the process; the amount of rich litharge produced depends on the skill of the workmen.

If the raw lead contains bismuth, this mostly oxidises towards the end of the process, forming a green coloured litharge, from which the bismuth may advantageously be extracted by Patera's process.

**The Period of Brightening.**—Owing to oxidation the

liquid metal attains a higher temperature than the interior of the furnace, and this temperature is slightly increased as the operation proceeds, owing to the temperature produced by the oxidation of the lead being concentrated in a smaller mass of metal. In consequence of this, some time before the end of the process, when rich litharge is produced, the alloy appears brighter than the surrounding hearth; but this brightness decreases as less lead is contained in the silver. If the litharge is not present in sufficient quantity to cover the whole surface of the silver, it will appear as a coherent net-work, through the meshes of which the silver shines brightly. As these contrasts of light and shade also assume the appearance of flowers and cloud-like drawings, this phenomenon is called the *flowering* of the silver. These different appearances at last disappear, the net seems to break, and single globules of litharge run towards the edges of the silver owing to its convex surface, and the silver appears of a uniform light and bright colour; this is called the *brightening* or *lightening* of the silver.\*

This brightening does not require the silver to stand in a certain proportion to the lead, but depends on several circumstances, chiefly the temperature, but also on the pressure of blast (which must be lessened at this period), on the greater or less depth of the hearth, &c., &c. It brightens sooner at a low temperature than at a high one, and less quickly on hearths of marl, in which the metal becomes finer, than in hearths of ashes. It is in most cases advisable to use a somewhat deeper hearth, thus causing a greater consumption of fuel, but less loss of silver, than a flatter hearth. The brightened silver is more or less impure according to whether its lightening is more or less hurried. It may contain from 3 to 6 per cent and more of foreign substances, chiefly lead.

The further purification of this silver is seldom effected in the cupelling furnace, and if so, it is in continuation of the former process. The heat is greatly increased, which causes the silver to take a strongly rotating movement; the blast is

\* DINGLER'S Polyt. Journ., Bd. 108, p. 287. B. u. h. Ztg., 1847, p. 204. Bgwksfr., x., 67.



conducted against the edges of the liquid silver till a sufficient fineness is obtained (Hungary, Siebenbürgen). This operation is difficult and expensive, causing great loss of silver and a large consumption of fuel. In Müsen\* the silver is refined in the cupelling furnace in about  $\frac{3}{4}$  of an hour or 1 hour without the use of blast; this is mostly effected in smaller hearths, in which the heat is better concentrated, or in crucibles.

After the silver has brightened it is cooled first with warm and then with cold water. It was found at Pontgibaud† that by cooling with water, silver formed roots in the hearth, and, therefore, the silver is better cooled by conducting a cold blast over it after having raked out the fire and opened the doors. If the silver is cooled neither by water nor by blast, the edges of the silver, which usually contain more lead than the middle, swell up; the brightened silver is seldom ladled out (Kongsberg).

After the hearth has cooled, for which purpose the dome must be removed, it is examined for silver roots, grains, or flaws, and is then broken with a hammer; it will be found impregnated with litharge and abstrich. The outer crust of litharge, which is 2 or 3 inches thick, is of radiated texture, and very compact and hard. It is worked up either by itself or in admixture at the ore smelting processes. The part of the hearth beneath the crust is used again in combination with some fresh marl for the formation of the new hearth.

The cupelling process is controlled either by assaying the raw lead and brightened silver, or by carrying on two processes in different furnaces at the same time with the same quantity of raw lead, allowing for a certain difference in the yield, which is more by 2 or 3 per cent in comparison with the assay when wood has been used, but is less when using coal. Cylinder blast engines also give a better yield than bellows.

The cupelling process causes loss of silver and of lead.

The loss of silver takes place—

\* B. u. h. Ztg., 1863, p. 92.

† B. u. h. Ztg., 1851, p. 360.

*a.* By volatilisation,\* the silver being volatilised deposits in an oxidised state as a red fume.

*b.* By entering into combination with the litharge and the hearth in an oxidised state, from which it can only be partly regained. The litharge contains oxidised silver, which may be proved by extracting the silver by means of ammonia,† and as the amount of silver in poor litharge is pretty constant (about 0·001 to 0·004 per cent), it is not to be supposed that this amount has always originated from intermixed raw lead.

According to Fournet's‡ experiments, silver becomes oxidised by oxide of lead, and remains as such as long as it is in contact with the oxidised lead, although free oxide of silver is reduced at a comparatively low temperature. The loss of silver is increased when the cupelling is too hot, too cold, or too quick.

*c.* By a mechanical inclosing of raw lead, chiefly in the last period.

The loss of lead takes place by volatilisation, either—

*a. Direct* by the influence of the high temperature and blast in the cupelling furnace. Condensation apparatus has been lately successfully used for condensing the lead fume, (Pontgibaud, Tarnowitz, Freiberg, &c.)

Reinecker|| has used the waste flame of cupelling furnaces for burning bricks and tiles, which are at the same time glazed by the lead fume.

The loss of lead (6 to 12 per cent) increases if the process is carried on too slowly, or at too high a temperature, and is greater when using coal than when using wood.

*b. Indirect*, as it is mostly necessary to reduce again litharge and hearth, and this cannot be done without loss.

### Illustrations of the German Cupelling Process.

#### 1. Cupelling without After-charge.

**With Wood.**—At the Lead Works at the Upper Hartz.§ At Clausthal one operation with a charge of 8½ tons of raw

\* LAMPADIUS, in Erdmann's Journ. f. ök. Chemie, iv., 281.

† ERDMANN'S Journ. f. pr. Chemie, xvi., 201.

‡ ERDMANN'S Journ. f. ök. Chemie, i., 49, 80.

|| Bergwkfd., xi., 617.

§ KERL, Oberharzer Hüttenprocesse, 1860.

lead in a cupelling furnace 10 feet wide and with a movable iron cap, requires about 32 hours, namely, 3 for the formation of the hearth, from  $2\frac{1}{2}$  to 3 for smelting, 2 for the first heating of raw lead, from 2 to 4 for the formation of abstrich, and 22 hours for the formation of litharge. The loss of lead is  $6\frac{1}{2}$  or 7 per cent, and 26 lbs. of brightened silver containing 93 per cent of silver are produced; besides  $6\frac{1}{4}$  tons of poor litharge containing 0.0012 per cent of silver and 90 per cent of lead; 16 cwts. of dross (first and last litharge) containing 0.0015 per cent of silver, and 90 per cent of lead; 15 cwts. of abstrich containing 0.0012 per cent of silver and 80 per cent of lead; and  $1\frac{1}{4}$  tons of hearth ends containing 0.0175 per cent of silver and 57 per cent of lead. 720 bundles of brushwood (each 42 inches long, 30 inches in circumference, and from 8 to 12 lbs. weight) are consumed. The cost of the process amounts to £4 14s. 2d.

At the lead works of the Lower Hartz\* the cupelling is done in furnaces with a fixed cap and with a charge of 9 tons of very impure raw lead. One operation requires from 28 to 34 hours, consuming about 480 bundles of brushwood, producing—

18.855 lbs. of brightened silver; 1.44 cwts. of commercial litharge; 120.35 cwts. of reducing litharge containing 86 to 90 per cent of lead and 0.031 to 0.062 oz. of silver; 6.03 cwts. of abstrich containing 74 to 90 per cent of antimonial lead and 0.062 to 0.186 oz. of silver; 36.91 cwts. of abzug containing 74 to 88 per cent of lead and from 0.75 to 1.37 ozs. of silver; and 28.11 cwts. of hearth ends containing from 68 to 85 lbs. of lead and 0.062 to 0.125 oz. of silver. The total loss of lead in the cupelling and reducing processes amounts to 13 per cent.

At Przibram† 6 tons of raw lead, containing from 8 to 21 ozs. of silver, are cupelled in furnaces with oval hearths  $9\frac{1}{2}$  and 7 feet in length respectively. The hearth is formed of a mixture of 200 lbs. of powdered limestone and 50 lbs. of white loam.

5 tons of raw lead containing 10 ozs. of silver yield, with a

\* KERL, die Rammelsberger Hüttenprocesse, 1861.

† Oesterr. Ztschr., 1856, p. 343.

consumption of 189·9 cubic feet of wood :—5·4 cwts. of abstrich ; 8·26 cwts. of black litharge containing 25 per cent of oxide of antimony ; 75·28 cwts. of commercial litharge ; 4·77 cwts. of rich litharge ; 15·58 cwts. of hearth ends ; and 61 lbs., 2½ ozs. of brightened silver.

At the lead works at Ems the cupelling furnace is 12 feet in diameter, and is furnished with two tuyeres. The hearth is formed of a mixture of 3 parts of lime and 1 part of loam. One charge consists of 17½ tons of raw lead containing 1·8 ozs. of silver per cwt., and the time required for the operation is from 52 to 60 hours, including 12 hours for warming. After having melted the lead, the dross formed (abzug) is removed, and for about 3 hours abstrich is formed by the influence of blast, and is skimmed off. The blast is then removed for an hour, and the litharge is taken away as often as the metal bath is found to be covered with it.

Five tons of raw lead, with a loss of 3·40 per cent of lead and 2·24 per cent of silver, yield 88·36 cwts. of litharge containing 81·99 per cent of lead (including 29·12 per cent of red litharge) ; 6·59 cwts. of abstrich containing 58·9 per cent of lead ; and 13·41 cwts. of hearth ends, consuming about 800 bundles of brush-wood.

The loss of lead upon 5 tons of raw lead amounts to—

In the cupelling process	. . . . .	3·40	per cent.
„ liquation process of the abstrich	. . . . .	0·10	„
„ reducing	„ „	residues 0·45	„
„ „	„ litharge	. . . 1·49	„
„ „	„ residues	. . . 0·12	„
		5·56	
Total	. . . . .	5·56	per cent.

As 5 tons of raw lead yield 7·11 cwts. of lead produced from abstrich and the residues which are again cupelled, causing a loss of 5·56 per cent, the total loss amounting to 5·95 per cent.

At Pontgibaud\* the cupelling process is carried on in furnaces 3 metres in diameter, furnished with 3 tuyeres, which are directed upon the opening whence the litharge runs off.

\* B. u. h. Ztg., 1851, p. 345, 375.

The material for the hearth is a mixture of 5 parts of marl lime, 1 of slaked lime, and 1 of clay. One charge consists of 9 tons of raw lead, and the process takes 84 hours, including the formation and charging of the hearth; altogether the blast is in action 39 hours. During the formation of litharge 12 cubic metres of blast are thrown in, and towards the end of the process from 9 to 10 cubic metres. The litharge is made to run into cast-iron pots with a capacity of from 360 to 400 lbs.

The loss of lead amounts to 6.25 per cent, and 1 ton of raw lead yields—

7.6 to 8.2 lbs. of brightened silver, containing 90 to 92 per cent of silver.

640 to 650 lbs. of abstrich, hearth, and abzug, containing about 60 per cent of lead.

1530 to 1550 lbs. of litharge, containing 92 per cent of lead.

The consumption of fuel is 750 bundles of brush-wood.

A similar process is used in Poullaouen.\*

At Kongsberg † a charge of from 3 to 3½ tons of raw lead (page 236), containing about 15 per cent of silver, is cupelled in furnaces 6 feet in diameter. The hearth of the furnaces is formed of 4 parts limestone and 1 loam. The blast is heated up to 200° C., and the process is finished in from 5¼ to 7 hours, causing a loss of from 0.2 to 0.4 lbs. of lead per lb. of fine silver produced. The hot blast not only causes a great saving of time and fuel, but also admits of the cupelling of raw leads difficult to fuse, containing 10 or 12 per cent of copper; 1,000 lbs. of lead are oxidised hourly. The brightened silver is ladled into moulds, and only the last remaining silver is allowed to cool in the furnace.

**B. With Coal.**—At the Tarnowitz Works the rich leads obtained in Pattinson's process are cupelled, and the antimonial slag and abstrich leads poor in silver are submitted to a concentrating cupellation for extracting their antimony; they are then submitted to Pattinson's process; part of the litharge produced is also sold as such.

\* Rrvor, *Traité de Métallurgie*, 1860, ii. 644. B. u. h. Ztg., 1859, p. 350.

† B. u. h. Ztg., 1855, p. 106, 117; 1862, p. 437.

The hearth of the cupelling furnace is formed of a mixture of 2 or  $2\frac{1}{2}$  parts of chalky clay and  $\frac{1}{2}$  part of pulverised fire clay, and is constructed deeper for rich cupelling than for poor cupelling, the better to concentrate the silver, which then forms fewer roots. By an addition of clay to the above mixture the loss of lead in the cupelling and reducing process has been diminished since 1858 to 3·8 per cent.\*

At the rich cupellation about  $6\frac{1}{2}$  tons of raw lead, containing 1·352 per cent of silver, are charged and cupelled in 24 to 28 hours, consuming about 53 cubic feet of coal. The brightened silver contains 93·75 per cent of silver.

Five tons of rich lead yield—

- 21 cwts. of abstrich, hearth, and lead ash.
- 90 „ of litharge.
- 128 lbs. of brightened silver.

The cost of the silver in this operation amounts to 2·4d. per lb.

The cupelling furnace at Vialas† is represented by Figs. 79 and 80. The hearth (*h*) consists of fresh and old marl in equal parts. The dome or cap (*D*) consists of an iron ring filled up with masonry; it is suspended by eight iron chains, and may be lifted by them. The furnace has one tuyere (*q*), which is connected with condensation chambers.

FIG. 79.

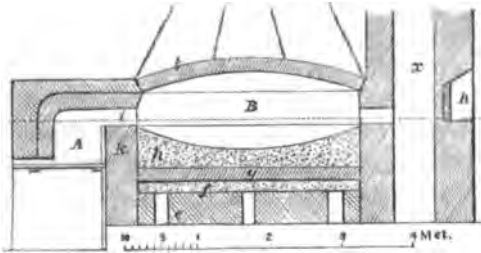

Charges of from 10 to 15 tons of raw lead, containing about 7·9 ozs. of silver per cwt., are added; 10 tons requiring

\* B. u. h. Ztg. 1860, p. 38.

† Rivot, *Traité de Métallurgie*, 1860, ii. 581, 599. Rivot, *Mémoire sur les Filons de Galène Argéntifère de Vialas*; *Annales des Mines*, tom. iv. 1863. B. u. h. Ztg., 1864, p. 380.

FIG. 80.

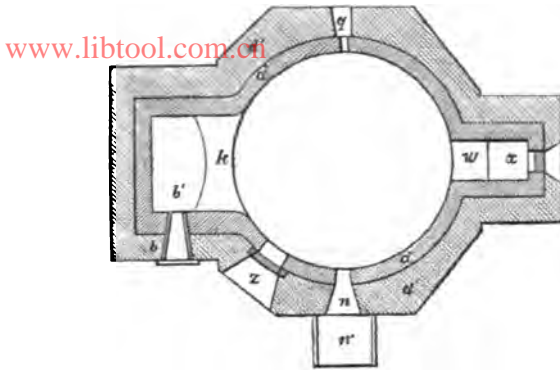

about 66, and 15 tons from 70 to 72 hours' time. 10 tons of raw lead yield—

93 lbs. of brightened silver, with 98 per cent of silver.  
2·70 tons of red litharge.

5·12	„	yellow litharge, with 93 per cent of lead and 0·085 oz. of silver per cwt.			
0·24	„	impure litharge, „ 90	„	0·085	„ „
0·35	„	rich litharge, „ 93	„	0·255	„ „
0·80	„	abstrich, „ 60	„	0·041	„ „
1·20	„	hearth, „ 50	„	0·170	„ „

Five tons of raw lead consume 19 or 20 tons of coal, and the cost of cupelling 1 ton of raw lead amounts to £1 2s. 5d.

### 11. Cupelling with After-charge.

**With Wood.**—At the Lead Works at Freiberg,\* the upper hearth of the furnaces is formed of marl, and the fume of the furnaces is conducted into condensation channels. The first charge consists of from 5 to 6½ tons of raw lead (page 135); this is covered with wood, and smelted with a blast. Little abzug and no abstrich result, on account of the purity of the lead which has been previously refined. As soon as the formation of litharge begins, the lead ash mixed with the wood and coal ash which are formed, is skimmed off, and when about 2½ tons of litharge have run out of the furnace, the after-charging commences, as described on

\* PLATTNER-RICHTER'S Vorlesungen über allgemeine Hüttenkunde, i., 207; ii. 256.

page 280, till from 16 to 17½ tons of raw lead are gradually cupelled. The blast is produced by a cylinder engine, and conducted without valves into the furnace. One operation takes from 75 to 80 hours' time, consuming about 162 cubic feet of wood. The resulting brightened silver, in blocks of from 400 to 600 lbs. weight, is furnished with an iron plate, which is put into them when still liquid, in order to facilitate the breaking of them.

At the Muldner smelting works there were produced from 5 tons of raw lead—

3'527	cwts. of abzug.
2'807	„ commercial litharge.
88'708	„ reducing litharge.
10'337	„ metalliferous hearth.
0'088	„ abstrich.

The cost of working 5 tons of raw lead is 17s. 1d. for fuel, and 13s. 7d. for labour.

At Kremnitz the hearths, 10 or 12 feet in diameter, are made either of artificial or natural marl. They are charged with 6 tons of rich lead, and afterwards with 4 or 5 tons more. One operation lasts from 48 to 54 hours, causing a loss of 6 or 8 per cent of lead and ½ to 1 per cent of auriferous silver. Five tons of rich lead consume 190 cubic feet of soft wood. The brightened silver contains 99·6 per cent of silver.

At the smelting works at the Altai,\* about 5 tons of raw lead, containing from about 0·42 per cent of silver (page 163) are cupelled in furnaces 7 feet in diameter, and having a hearth of marl. When the abstrich is removed, so much lead is afterwards added that the total charge amounts to about 10 tons. The process takes 2 or 3 days, causing a loss of 10 or 12 per cent of lead. The produce is about 80 lbs. of auriferous brightened silver, containing 90 per cent of silver and 3 or 3½ per cent of gold, besides dross, litharge, and hearth.

**With Coal.**—At Lohet† (Siegen), about 1,300 cubic feet of wood were formerly consumed in cupelling 30 tons of lead, whilst now 355 cubic feet of coal and 108 cubic feet of

\* B. u. h. Ztg., 1853, p. 179.

† Preuss. Ztschr., 1862, x., 222. B. u. h. Ztg., 1862, p. 91.



wood (for firing during the last 24 hours) are used, causing a saving of £2 5s.

At Holzappel the German cupelling furnace, with a fixed cap and a hearth 10 feet in diameter, is used. The hearth is formed of 1 part of clay and 2 of limestone, with an addition of  $\frac{1}{3}$ rd of old hearth.

Five tons of lead are first added, and heated gently for 42 hours in order to preserve the hearth; it is then charged till the hearth is filled, and a strong fire is made to melt the lead, the blast being put on. After having removed the abstrich, and when the formation of litharge has commenced, the after-charging is continued till about 35 tons have been added: the process takes about 10 or 11 days.

The litharge is made to run out from time to time as the metal bath becomes covered with it, and the firing is so regulated that the cupelling is conducted at as low a temperature as possible, and a strong fire is only given when opening the gutter in order to render the litharge very liquid. This treatment is said to diminish the loss of lead and silver. Two gutters are alternately opened to remove the litharge.

The resulting products are:—Brightened silver, containing 79·1 per cent of silver; pure litharge, containing 90·3 per cent of lead and 0·004 per cent of silver; impure litharge from the period preceding the brightening, containing 88·8 per cent of lead and 0·33 per cent of silver; smoke, containing 50·4 per cent of lead and 0·001 per cent of silver; and abstrich, containing 70·6 per cent of lead and 0·012 per cent of silver. The loss of lead amounts to 3·29 per cent, and the loss of silver to 4·09 per cent.

100 lbs. of raw lead yield—

0·1178	lbs. of brightened silver.
0·94	„ abstrich.
0·19	„ metallic fume.
92·09	„ litharge for reducing.
5·36	„ do. sale.
0·55	„ do. impure.
11·37	„ coarse hearth.
1·51	„ fine hearth.

The cost for cupelling is—

	For 100 lbs. Lead.	For 100 lbs. Litharge.
Labour . . . . .	1'9d.	2'1d.
Fuel . . . . .	5'7d.	6'2d.
Clay and Lime . . . . .	0'9d.	0'9d.
Tools . . . . .	0'5d.	0'6d.
Blast and sundries . . . . .	2'3d.	2'6d.
Repairs . . . . .	0'3d.	0'3d.
<b>Total . . . . .</b>	<b>11'6d.</b>	<b>1s. 0'7d.</b>

**III. Cupelling with Concentration of the Raw Lead.**

At Tarnowitz, raw lead resulting from reduction slags, and containing 0'015 per cent of silver and traces of anti-mony, is smelted in quantities of 8½ tons in the cupelling furnace without removing the abzug, a low pressure blast being put on to extract the antimony. As soon as black slags form they are skimmed off together with the abzug.

As soon as pure litharge comes the pressure of blast is gradually increased to 150 cubic feet per minute; lumps of litharge are formed, which are afterwards separated into red and yellow litharge.

As soon as the silver present has become concentrated to about 13 times its original amount (on an average 0'2 per cent), the rich lead is tapped off through a hole beneath the opening for litharge, and afterwards treated by Pattinson's process.

Five tons of raw lead, consuming about 40 cubic feet of coal, and costing £1 3s. 4d., yield—

8'07	cwts. of black litharge and abstrich.
82'92	„ litharge.
20'70	„ metalliferous hearth and lead ash.
12'00	„ concentrated raw lead.

**THE ENGLISH SYSTEM OF CUPELLATION.**

This process is carried on in smaller furnaces furnished with a movable hearth (which is formed outside the furnace), and with a flat fixed roof. These furnaces are heated with

coal, and the charging is gradually effected either with liquid or solid lead. Pure raw leads poor in silver are usually treated by this method, and they are mostly concentrated till the silver amounts to 7 or 8 per cent, and sometimes 50 per cent; they are then tapped off, and submitted afterwards to a chief cupellation. Since the more general use of Pattinson's process, these poor raw leads are usually treated by it previous to the cupelling process, which is then carried on with the rich lead, either for the production of brightened silver, or to cause a previous concentration of the silver. The resulting litharge is reduced, and the lead obtained again treated by Pattinson's process.

The English process has all the advantages which the German process offers in the after-charging and concentration of raw lead, but requires pure lead, otherwise impure litharge would result, and from it impure lead which would require to be refined. On the other hand, the English furnaces sometimes produce less than the German furnaces; for instance, at the furnaces on the Upper Hartz (at Altenau), 5 tons of rich lead are cupelled in 25 or 27 hours, consuming 480 to 540 bundles of brush-wood, while an English furnace can only provide for the cupellation of 10 tons of raw lead in about 5 days, consuming 10 or 12 cwts. of coal daily.

FIG. 81.

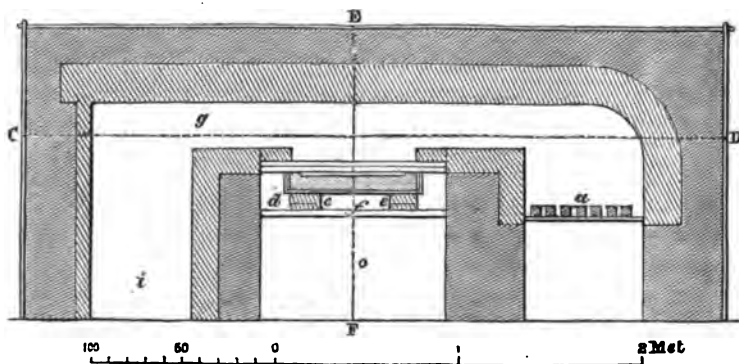

FIG. 82.

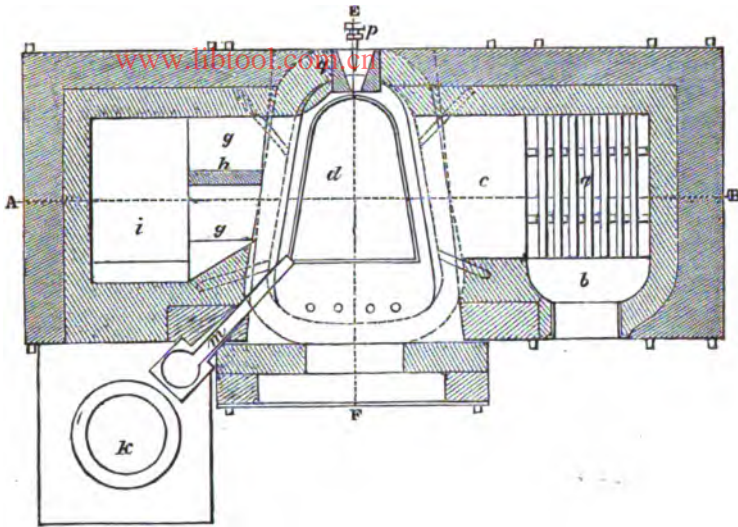
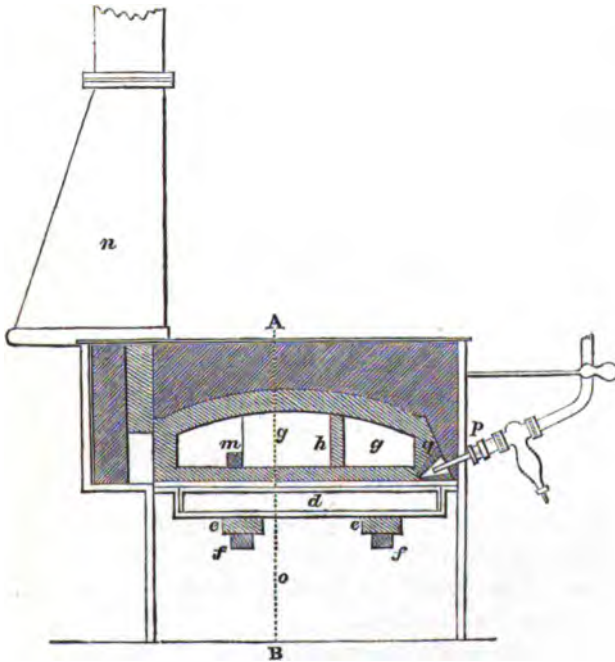
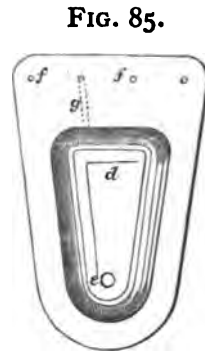
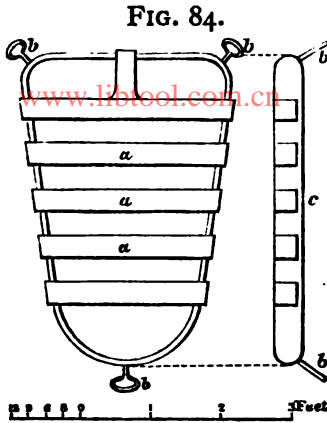

FIG. 83.





The cupelling furnace used at Stolberg is represented by Figs. 81, 82, 83, 84, and 85; *a*, is the grate; *b*, the opening for putting the fuel on to the grate; *c*, the fire-bridge; *d*, the test ring (hearth) resting upon the stones, *e*, and the iron beams, *f*, sometimes upon an iron car; *g*, is the flue leading into the channel, *i*, which communicates with the chimney. The flue is divided into two parts by the division wall, *h*. *k*, is a pan for fusing the rich lead, which is ladled into the gutter, *m*, and conducted by it to the hearth, *d*; *n*, is the chimney stack on the working side of the furnace; *p*, the tuyere for admitting blast or steam.

The mass for the hearth consists of pounded calcined bones, mixed with about 5 per cent of potash or soda, or some wood ashes. This is moistened with water, and beaten into the test ring, *c*, which is furnished with handles, *b* (Fig. 84), and then a hollow, *d* (Fig. 85), about 2 inches deep, is made in it for the reception of the cupelling lead; *e*, is the opening in the hearth for tapping off the concentrated rich lead; it is closed with bone ash during the cupelling process; *f, f*, are openings for conveying the litharge by means of gutters, *g*, into iron pots standing below the hearth upon an iron waggon. Two workmen are able to prepare a hearth in one shift of 12 hours. The hearth is fixed in the furnace after having been dried for 8 or 10 days.

Bellows and ventilators may be used as blast machines if

no cylinder machine is available. Sometimes steam\* of the pressure of  $1\frac{1}{2}$  to 2 atmospheres is employed instead of blast (Stolberg, Belgium, and the Gallongate Lead Works at St. Anthony, near Newcastle). It is said to hasten the cupelling process and to produce superior litharge, and occasionally it is cheaper than blast. The nozzle for conducting the steam is put into a wider tuyere, so as to admit some air, and it appears that the steam has not much chemical influence, but rather occasions a draught which renders a further blast unnecessary.

**Manipulations in Cupelling.**—After having been formed as described, the cupel is dried for several days, and then introduced beneath the arch, and wedged firmly in its place. The furnace is then heated very carefully, lest the cupel should crack. When the temperature reaches a dark red, some lead, which is kept fused in a pot close by, is poured into the cupel, the blast is put on, and the fire increased until the lead reaches a bright red heat.

The formation of litharge takes place rapidly, and as fast as produced it is allowed to run off through a channel which is kept of a constant depth, and about two inches wide. The litharge is kept in the furnace in such a way that it forms a border 6 or 8 inches wide round the edges of the metallic bath, and the temperature and blast are maintained sufficiently high to render the litharge liquid enough to run off uniformly. As the lead is oxidised, and its level becomes lower, more molten lead is poured in, and thus about 500 or 600 lbs. of metal are constantly kept in the hearth. In some cases the lead is charged in pigs by means of an inclined iron plate, through an aperture on the side of the tuyere.

The litharge is received in large cast-iron pots, allowed to cool, and removed in a solid state from the vessels by turning them upside down. As the silver remains in the hearth, while the lead continually oxidises and flows off, the proportion of silver increases. When 4 or 5 tons have been added, and the mass in the hearth has been concentrated until it contains about 8 per cent of silver, the operation of the

\* KARSTEN'S Archiv., 2 R., xxv., 577.

furnace is arrested, and its contents run into moulds. The second shift is then commenced by adding 500 or 600 lbs. of fresh lead to the cupel, and the operation proceeds as before. Thus a single cupel will often last 48 hours, and 6 or 7 tons of lead may be oxidised upon it.

For the especial treatment of the concentrated alloy, the cupel is placed in the furnace, and brought to a dull red heat; about 600 lbs. of lead are then added after having been fused in a neighbouring pot, and a strong current of air admitted. Immediately the lead begins to oxidise, and the litharge produced flows off into a vessel provided for the purpose, while at the same time the attendant adds lead to keep the metal in the cupel always at the same level. In this manner some three tons of the alloy of lead and silver are added, and about 500 lbs. of silver are collected in the cupel. The attendant then ceases to add rich lead, and allows the silver to purify; the phenomenon of brightening is soon perceived, the fire is lowered, the blast stopped, and the cake of silver is allowed to cool slowly. The iron waggon, with its subjacent hearth, is now drawn from beneath the vault of the furnace, the silver taken from its bed in the bone ash, cleaned of its coating of impurities, and submitted to the refining process. It is either purified by melting in a plumbago crucible, or by a second oxidising fusion in a bone ash cupel.

The litharge produced in this last operation grows gradually richer in silver towards the end of the cupellation. It is all reduced to a lead usually containing from 30 to 40 ounces of silver to the ton, and, after being treated by concentration, is again treated in the cupelling furnace.

### Illustrations of the English Cupelling Process.

At some lead works near Newcastle, a furnace of moderate dimensions requires 2,000 common bricks, 2,000 fire bricks, and  $1\frac{1}{2}$  ton of fire clay. The fire-place is 22 inches by 24 inches, the fire-bridge from 14 to 18 inches broad, and

\* B. u. h. Ztg., 1859, p. 434; 1862, p. 300. Berggeist, 1861, p. 339. Rivot, *Traité de Métallurgie*, 1860, ii., 288, 364.



the chimney 40 feet high; the hearth (test ring) for receiving the cupel consists of a strong wrought iron ring, nearly elliptical in shape, 4 feet by  $2\frac{1}{2}$  to 3 feet, and with a framework of iron bars,  $3\frac{1}{4}$  inches broad,  $\frac{1}{2}$  to 1 inch thick,  $4\frac{1}{2}$  inches space between them, across the bottom; the cupel is about 1 inch thick in its middle. One furnace cupels 5 cwts. of lead per hour, consuming 4 cwts. of coal per ton of rich lead. The cost of cupelling 1 ton of rich lead containing 400 ounces of silver, is 10s. 10d.

Four and a half tons of lead are concentrated to 1 cwt. in 16 or 18 hours; this is tapped off and refined when sufficient concentrated alloy has been produced.

The resulting litharge is reduced in reverberatory furnaces, the slags of the litharge reducing process are worked in a slag hearth for the production of hard lead.

At the lead works of Münsterbusch and Binsfeldhammer, near Stolberg, raw lead which has been concentrated by Pattinson's process up to 1 per cent of silver is cupelled in English cupelling furnaces by the application of steam at a pressure of  $1\frac{1}{2}$  to 2 atmospheres, and concentrated till it contains upwards of 7 per cent of silver. In this way  $10\frac{1}{2}$  tons are reduced to 7 cwts. in 18 hours. When this rich lead is cupelled for the production of brightened silver, wood is used for firing in the last period of the process. The brightened silver is tapped off, and afterwards refined in plumbago crucibles, 15 inches high and 10 inches in diameter on the top.

50,300 lbs. of lead containing 1 per cent of silver were concentrated in 16 shifts of 24 hours each, and the cupelling of the rich lead containing 7 per cent of silver in 3 shifts, requiring two hearths. The result was, 514 lbs., 11 ozs. of brightened silver; 45,000 lbs. of poor litharge, with about 7 ozs. of silver in a ton; 4,000 lbs. of rich litharge; 50 or 60 lbs. of abstrich, and some lead hearth. The consumption of fuel amounted to  $6\frac{1}{2}$  tons of coal, 115 cwts., 20 lbs. of small coal, and 180 lbs. of small coal for heating the boiler. The wages of the chief melter are 2s. per shift of 12 hours, and the assistants receive 1s. 6d.



**REFINING THE BRIGHTENED SILVER.**

The refining process\* aims at the complete removal of the impurities which the cupelling process has left in the brightened silver. These impurities are chiefly lead, bismuth, antimony, copper, &c. A small amount of lead, bismuth, antimony, and arsenic renders the silver brittle; copper does not injure the ductility of the silver, and sometimes it is purposely retained when it is to be alloyed with that metal (Freiberg).

In rare cases silver is refined in the wet way, but this is usually when it contains a fair amount of gold.

If the impurity in the silver consists only of lead, the refining process is very simple, but the reverse is the case when the silver contains much copper, arsenic, and antimony, with but little lead, as these substances are only removed by a very long reaction of the atmosphere during refining; the brightened silver requires more heat for smelting the less lead it contains. In some cases it is advantageous to give an addition of lead to the brightened silver, so as to oxidise and carry away the other base metals.

Karsten calculated that 18 parts of lead were required for 1 part of the contaminating base metals. When refining brightened silver containing nickel and cobalt, which cupel with difficulty and show a great inclination to a quick chilling, a little copper may be added advantageously, as it increases the heat in the metal bath. The refining process differs from the cupelling process in the circumstance that the formed litharge does not flow off from the surface of the silver, but becomes imbibed by the porous refractory test (ground bone, marl, wood ash).

The test is either prepared on a movable hearth (like the English cupelling furnace) or on the fixed bottom of a reverberatory furnace; crucibles are also used for the refining process, and the refining may be effected by the assistance of blast or under a muffle.

These operations vary in their consumption of fuel, the volatilisation of silver, and the largeness of production.

\* B. u. h. Ztg., 1864, p. 81.

To refine 100 lbs. of brightened silver, there are consumed—

In reverberatory furnaces with firing of wood gas (Mansfeld)	70	lbs. charcoal.
„ crucibles	76	„ „
„ reverberatory furnaces with firing of coal	88.4	lbs. coal.
	6	„ charcoal.
By blast	88	„ „
	66	„ wood.
Under the muffles	150	„ charcoal.

Of all apparatus the reverberatory furnaces are the best, consuming the least fuel, and causing the least loss of silver. The loss of metal is largest when applying blast, and is also considerable when refining under the muffle. Whether the hearth in the reverberatory furnaces shall be fixed or movable depends chiefly on the extent of the production; fixed hearths are better for larger operations (Mansfeld, Freiberg, Przibram, &c.)

The products of this refining process are,—

1. **Refined Silver**, almost pure, being '998 to '999 fine. A singular phenomenon is often observed when pure silver is fused in air and cooled rapidly. Upon the exterior of the mass becoming hardened the interior seems to expand, and fracturing the thin crust, sends out branches of what appear like a species of metallic vegetation. This phenomenon is considered as a sign of the fineness of the silver, and is caused by the escape of the oxygen which had been absorbed by the silver. Lucas\* found that liquid silver absorbed at least 20 times its volume of oxygen from the air, and Plattner concluded that silver became oxidised at the high temperature, and that, like copper, silver was capable, while in a fluid state, of absorbing a large quantity of its oxide, and that at a reduced temperature this compound could not exist, but became suddenly decomposed at the moment of cooling, liberating its gas. According to Rose,† silver melted under a layer of saltpetre absorbs oxygen, and sets it free in the same manner, but not when melted under a layer of common salt or potash. By throwing particles of silver into the air the sudden liberation of gas causes a loss, which may be prevented by allowing the mass to cool very slowly, or by keep-

\* KARSTEN'S Archiv., 1 R., iv., 318. ERDMANN, Journ., f. ök. u. technische Chemie, i., 487; ii., 395; x., 286.

† B. u. h. Ztg., 1861, p. 391.

ing the surface of the silver broken by means of a stirrer during the sudden cooling by water ; it is still better to cover the silver before cooling with small coal, which burns rapidly in the escaping oxygen.

The presence of copper and lead in the silver prevents the absorption of oxygen, not so the presence of gold.

If the surface of the liquid silver assumes a mirror-like brilliancy it is considered fine.

Ingots of refined silver of the Upper Hartz have a larger amount of silver in the top part than in the bottom, retaining some lead, without which commercial silver is seldom found.

Upper part.	Lower part.	Average.
999 <sup>4</sup>	995 <sup>4</sup>	997 <sup>4</sup>
998 <sup>4</sup>	997 <sup>4</sup>	997 <sup>9</sup>
999 <sup>4</sup>	994 <sup>4</sup>	996 <sup>9</sup>
999 <sup>4</sup>	995 <sup>4</sup>	997 <sup>4</sup>

Water sometimes enters the upper porous parts of the silver which has been cooled by quenching in it.\*

2. **Hearth Ends**, containing oxide of lead, suboxide of copper, and silver, partly mechanically intermixed, and partly in an oxidised state.

An amount of bismuth in the ores concentrates in the hearth ends (page 284), and may be extracted profitably either in the dry way by Patera's plan of partly cupelling the bismuth alloy, or in the wet way by treating the hearth ends with dilute hydrochloric acid, precipitating the basic chloride of bismuth by diluting with water, and reducing the dried product.

### Refining in Cupelling Furnaces.

This simple method is rarely employed, as it causes great volatilisation of silver, and a larger consumption of fuel ; it is conducted at the lead works in Lohe (Siegen) in the following way. After the brightening of the silver the blast is turned off, and the oxidation process is carried on by a continued heating until the silver shows a bright, mirror-like surface. The resulting fine silver contains 99<sup>6</sup> to 99<sup>7</sup> per

\* DINGLER'S Polyt. Journ., Bd. 98, p. 225.

cent, and to produce a greater fineness would cause an increase in the volatilisation of silver.

In some cases it may be advantageous to produce a greater fineness than usual in cupelling furnaces, and afterwards to purify it completely by the cheaper re-melting in crucibles (Vialas, Pontgibaud).

### Refining by the Aid of Blast.

This plan is only adapted for impure silver requiring a stronger oxidation of the foreign substances, and, though it consumes little fuel, and requires a simple apparatus, it is not easily conducted, and causes a great loss of silver. It is carried out on small tests of marl from 9 to 11 inches wide, and about 3 inches deep, standing under a chimney close to a fire-proof wall, which is furnished with a tuyere. After having charged the test with from 20 to 30 lbs. of silver, some glowing coals are put before the tuyere, and a ring of iron plate is placed round the test to keep the coals together, with which the test becomes filled up, and the blast is turned on, giving about 18 cubic feet per minute. As soon as the silver is melted, the iron ring is removed, and also the glowing coals from the surface of the silver, and the required temperature is sustained by, from time to time, placing some glowing coals and pieces of wood between the hearth and tuyere; so that the blast only conducts the flame across the fluid surface. The silver is repeatedly stirred, and the process continued until no more litharge is formed, and the silver assumes a mirror-like brilliancy; the silver is then carefully cooled by pouring water over it. The process is finished in 1 or 1½ hours, and consumes 2·2 cubic feet of charcoal, and 1·1 cubic feet of wood.

### Refining in the Muffle.

This mode of refining consumes most fuel; it also causes a great loss of silver, and produces cakes which are of different purity in different parts, but it has the advantage of being easily conducted, and of a neatness of manipulation;

it is therefore adapted for plumbiferous brightened silver, which does not contain much lead or other impurity.

[www.libtool.com.cn](http://www.libtool.com.cn)

#### Illustrations of this Process.

*At Oker,\* on the Lower Hartz*, the test is 1 foot 1 inch in diameter, and 2'15 inches deep, and is made of marl, and covered with ground bone; it is placed in a muffle standing in a small, strongly curved cupola furnace, open in front, and in whose lower periphery are openings communicating with the outer air; the draught may be regulated by closing them more or less; from 40 to 45 lbs. of silver are charged, and the air-holes on the muffle closed, large coals are put round the muffle, and the front air-holes closed with bricks, leaving an opening communicating with the mouth of the muffle; the furnace is then filled up with coal and lighted. After the silver is melted the coal from the mouth of the muffle is taken away, the silver is frequently stirred, and the process is carried on, alternately opening and closing the working door, according to the temperature required, till no more litharge is produced and the silver has assumed a mirror-like surface. The silver is then cooled by water.

Soft coal has a better effect than hard charcoal; 50 lbs. of brightened silver give on an average  $47\frac{1}{2}$  lbs. of fine silver, consuming in 5 hours, by which time the process is finished, 7'5 cubic feet of charcoal.

At the Mint in Clausthal† (Upper Hartz), the furnaces are similar to those used at Oker. The tests are made of washed wood ashes and burned lime, and are used in two sizes. The smaller ones are charged with 28 or 30 lbs., and the larger with from 35 to 45 lbs. of silver produced in the lead works of the Upper Hartz.

Forty-five pounds of silver are melted in about two hours, while the mouth of the muffle is closed as in Oker; it is then opened and the silver stirred several times; the muffle is closed for half an hour, and the silver is then stirred again. This is usually done three times, at intervals of half an hour,

\* KERL, *Unterharzer Hüttenprocesse*, 1861, p. 136.

† KERL, *Oberharzer Hüttenprocesse*, 1860, p. 465.

and the last heat is given for half an hour. When the silver is of mirror-like brilliancy it is allowed to cool slightly, and then water is poured upon it, the spitting of the silver being prevented by keeping an opening in the middle of the cake by means of a hook; the diminution in weight is about  $1\frac{1}{2}$  ozs. per lb.

*At Victor Friedrichshutte*, the tests rest on the narrow sides of bricks, by which arrangement they are also heated from the bottom. The process gives 95·1 per cent of fine silver. 50 lbs. of brightened silver consume 375 lbs. of charcoal, and about 1 cubic foot of old marl from cupelling furnaces, and 3 lbs. of ground bones.

### Refining in Reverberatory Furnaces.

This method is the most advantageous as regards consumption of fuel, largeness of production, rapidity, and economy; it also causes no larger loss of silver than the other plans. The hearth is either movable or not, according to the scale of the production.

To lessen the volatilisation of silver it is melted as quickly and judiciously as possible, under a covering of small coal and saw-dust, which is kept longer upon it, as more antimony, lead, arsenic, &c., are present; the application of blast will accelerate the separation of such substances; the refining of silver containing bismuth is more difficult. After the dross has been skimmed off, the spots of litharge formed upon the surface of the silver are allowed either to be absorbed by the test, or they are removed by spreading bone ash over the silver; this at the same time counteracts an evaporation of the silver. The velocity with which the spots of litharge move towards the edges indicates the temperature of the furnace. If the melting takes place with too much difficulty, a percentage of lead is sometimes added, and if the silver refines too slowly and is inclined to chill easily, some copper is added.

When using furnaces with a fixed hearth, the refined silver is ladled out (Freiberg, Mansfeld, Przibram), and when using a movable hearth it is either cooled in the furnaces (England, Tarnowitz), or tapped off (Poullaouen), or it is removed by

tipping over the hearth (Kongsberg). Refining furnaces are sometimes furnished with two hearths, one above the other; the upper one is used for warming the silver, and the lower one for refining it (Poullaouen).

### Refining in Reverberatory Furnaces with Movable Hearth or Test.

The hearth either rests upon iron beams (England), or is carried to the furnace by means of an iron car, and then secured by screws (Tarnowitz), or it is suspended on trunnions by means of which it may be tipped over (Kongsberg). The fuel is coal and wood (Holzappel), and the test is prepared of ground bones, marl, or finely sifted slag from the smelting of black copper (Kongsberg).

#### Illustrations of the Process.

At *Tarnowitz*, the refining furnaces are represented by Figs. 86 and 87; *a*, is the opening for throwing fuel upon

FIG. 86.

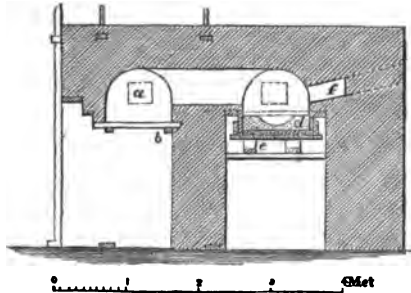
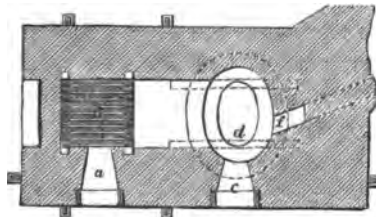

FIG. 87.



the grate; *b*, the grate; *c*, the working door; *f*, the flue communicating with a chimney 50 feet high. The test, *d*,

was formerly placed upon the iron beams, *c*, but it is now put upon a car, after having been dried and charged with brightened silver; the car is carried to the furnace by means of a railway, and raised by machinery to the required height. The joints between the test and furnace masonry are covered with bone ash.

The molten silver is then stirred and exposed to the atmospheric air till its surface indicates the fineness of the metal.

In 1862 there resulted from 100 lbs. of brightened silver, 96·812 lbs. of fine silver of ·999 fineness, and 19 lbs. of metalliferous hearth. The cost was 1·4d. per lb. of fine silver, and 9 cubic feet of coal and 32·18 lbs. of bone ash were consumed for each 100 lbs. of fine silver yielded.

In *England* the furnaces used are similar in general construction to that before described (Figs. 86 and 87). About 480 lbs. are treated at once upon a bone ash cupel (test), and each operation requires about six hours. The fine silver is either allowed to cool on the cupel, or is tapped off by a tap-hole in the bottom of the cupel, or it is ladled out if several charges of silver are to be refined in succession. Silver of a fineness of 0·985 is brought to an average fineness of 0·998, and when the operation has been carried on with more than ordinary care, the quality will reach 0·9995, rising at times to pure silver.\*

At *Poullaouen*.†—The furnace represented by Figs. 88 and

FIG. 88.

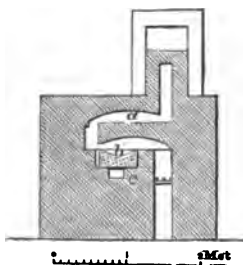
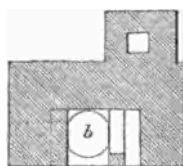

FIG. 89.



\* MAKINS, *Manual of Metallurgy*, p. 144. London: 1862.

† B. u. h. Ztg., 1859, p. 350. RIVOR, *Traité de Métallurgie*, 1860, ii., 617, 648.



89 is furnished with two hearths. On the upper one the silver is previously heated, the cake being broken into two pieces for this purpose. The cupel, *b*, is composed of lime and clay, and is heated till it is red hot, which takes place in about 4 hours; about 40 or 42 lbs. of brightened silver are then added and refined in from  $2\frac{1}{2}$  to 3 hours, consuming about 1 ton of wood. The fine silver is tapped off into 2 moulds, which are placed in the opening, *c*, one after the other; the produced silver has a fineness of 0.997.

*At Huelgoet*\* the process is similarly carried on.

*At Kongsberg*† the furnace is similar to that of Tarnowitz, but it differs in the make and the mode of fixing the cupel. It has been before stated that the cupel mass consists of slag from the smelting of black copper. This slag possesses some advantages in working up the hearth ends. The test ring is furnished at both ends with 2 strong iron plugs, fitting into 4 double claws of an iron car. The car is moved on rails into the opening beneath the furnace, and the cupel is fixed in such a way that it may be lowered in front whilst resting on the plugs at the back. In this way the pouring of the fine silver into moulds is effected. 1,911½ lbs. of brightened silver yielded by the refining process 1,766 lbs. 6 ozs. of fine silver, 16 lbs. 6 ozs. in the furnace ends, and 7 lbs. 3 ozs. in the fume.

The furnace ends are re-melted in small cupola furnaces, producing an alloy similar to brightened silver, which is added to the refining process. The matt, which is produced at the same time, containing from 4 to 5 lbs. of silver per cwt., is worked up by one of the fusion processes with lead, and the slag, containing 1 or  $1\frac{1}{2}$  ozs. of silver, is added to the raw smelting.

#### Illustrations of the Process of Refining in Furnaces with Fixed Hearths.

These furnaces are mostly used for larger charges (up to  $1\frac{1}{2}$  tons.)

\* Rivot, c. i., p. 625.

† TUNNER'S Jahrbuch, 1852, p. 192. B. u. h. Ztg., 1855, pp. 106, 117; 1856, p. 164; 1862, p. 437.

At *Prxibram*.\*—The refining furnace is shown by Figs. 90 and 91. The iron plate, *a*, supports the hearth, *k*, which is  
[www.libtool.com/en](http://www.libtool.com/en) FIG. 90.

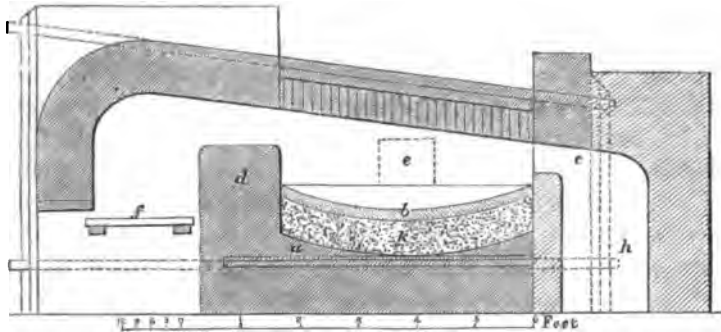
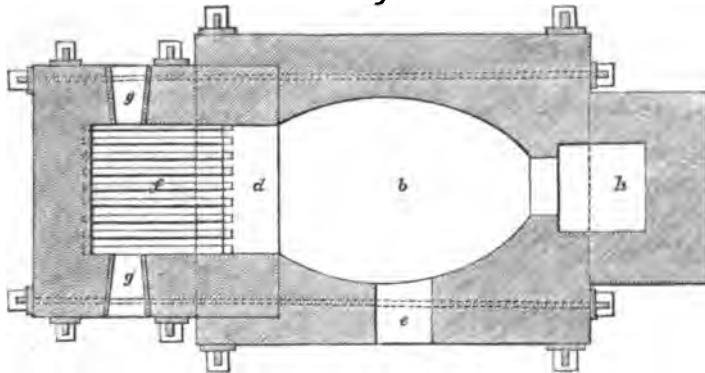

FIG. 91.



8 inches high, and composed of clay and pieces of bricks  $1\frac{1}{2}$  or 2 cubic inches in size. *k* is covered by the hearth *b*, formed of 2 parts of fresh marl and 1 part of old marl, and 3 inches thick in the middle. The deepest point of this hearth lies 8 inches beneath the lower edge of the working door, *e*; *h*, is a channel communicating with the flue, *c*, and leading into the chimney.

One charge consists of 1 ton of silver; it is covered with small coal or saw-dust, and melted in  $2\frac{1}{2}$  hours, with a low fire for the first  $\frac{1}{2}$  hour, and with a stronger firing during the next 2 hours. The silver is stirred, the dross skimmed off, and every  $\frac{1}{2}$  hour some test ash, consisting of two volumes of

\* Oesterr. Ztschr., 1858, p. 52.

wood ash, and 1 volume of bone ash, is thrown over the metal bath. If the metal becomes fine in 5 or 6 hours the test ash is removed, the silver is covered with small charcoal to prevent its spitting, then ladled out, and the furnace is re-charged; the consumption of coal is from 5 to 6 cwts.

*At Freiberg.*—The refining furnace has a hearth 4 feet long and 3 feet broad, a grate with a surface of 12 square feet, and a chimney 70 feet high and 20 inches in diameter ( $\frac{1}{4}$  of the surface of the grate); the furnace is furnished on both sides of the fire-bridge with tuyeres  $\frac{1}{2}$  inch wide. The smelting hearth consists of a mixture of three parts old marl and five parts fresh marl, and rests upon a hearth formed of old bricks, supported by a strong iron plate. When the hearth is red hot a ton or a ton and a quarter of brightened silver is gradually added, and quickly melted under a covering of charcoal and wood, the air being excluded as far as possible. After 3 hours, when the silver has become rather hot, the blast is turned on at a low pressure, the metal bath is stirred from time to time, and some marl is spread upon it for absorbing the litharge. The fineness of the silver is observed by a sample which is ladled out for this purpose (lustre, colour, and ductility), and when sufficient fineness is obtained, the silver is covered with charcoal, and ladled into cast-iron moulds, forming ingots of 18 or 20 lbs. weight each. During this ladling the heat is increased, so as not to allow the silver to chill in the furnace.

The process is finished in 10 or 12 hours, yielding silver of 99.6 to 99.8 per cent fineness, causing a loss of 3 to 3½ per cent of silver, and consuming about 45 cubic feet of soft slate coal.

FIG. 92.

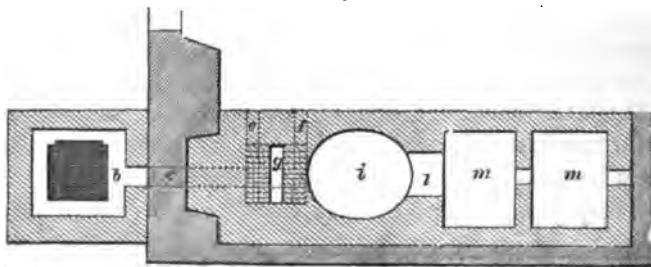

At Mansfeld,\* the refining furnace in use is shown by Figs. 92 and 93. It is provided with an apparatus, *b*, for generating

www.libtool.com FIG. 93.

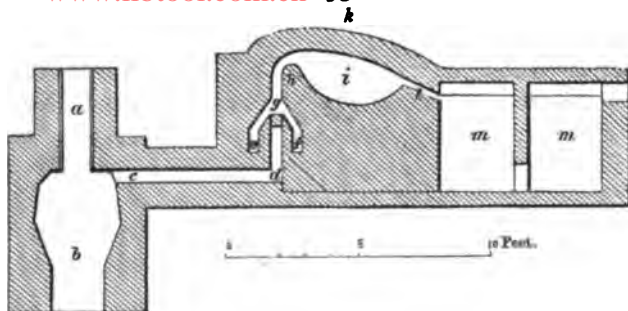

gas from hard charcoal, which is charged by *a*; the gas enters by the horizontal channel, *c*, into the vertical channel, *d*, and from thence by the openings, *e* and *f*, into the channel *g*, where it is mixed with atmospheric air, which has access through several flues—*h*, is the fire-bridge; *k*, the arched roof; *l*, the flue; *m, m* are condensation chambers. The smelting hearth is formed of washed wood ash with 12 per cent of lime.

After the hearth has been dried for 12 hours, and heated for 6 hours longer with about 7 cubic feet of coal, the apparatus for the generation of gas is heated with wood until the furnace has become hot enough to ignite by its own heat the oxide of carbon produced; when this does not take place, explosions may occur in the condensation chambers; the apparatus is afterwards charged with charcoal.

The precipitated silver obtained by Ziervogel's process, and which is contaminated with gypsum, metallic copper, and sulphates, is charged in lots of about  $\frac{1}{2}$  ton, two or three times in succession; each time when the previous charge is melted, the silver from the residues of the last process is added; the smelting is performed in  $6\frac{1}{2}$  or 7 hours, the doors being closed. The frothy slag formed is now skimmed off, a strong fire is made up for some time, and then the generation of gas is interrupted, the working door is opened and the dross

\* GRUTZNER, die Augustin'sche Silberextraktion, 1851, p. 118.

removed from the silver till it has the appearance and quality of fine silver. It now has a fineness of 98·0 to 98·3 per cent. It is removed in iron ladles which have been previously warmed and coated with clay; the ingots formed weigh from 30 to 40 lbs.

The dross is once more put into the hot furnace to melt out the silver mechanically contained in it; the residues and the hearth are pounded and sifted to separate the enclosed silver grains; they are then mixed with 12 per cent of sulphuric acid, and exposed for two or three days to a temperature of from 60 to 80° C., and then slightly roasted in a reverberatory furnace for  $1\frac{1}{2}$  or  $1\frac{3}{4}$  hours till sulphate of silver is formed. After cooling it is again treated with 6 per cent of sulphuric acid, and then a third time in the same way, when it will be found that the residues only contain 8 or 9 ozs. of silver per cwt., which are worked up together with the copper matt.

1,000 lbs. of precipitated silver consume in 12 hours about 7 cubic feet of charcoal and 120 bundles of wood for warming, and 68 cubic feet of charcoal for refining. 5 tons of precipitated silver of 86—87 per cent fineness yield  $3\frac{3}{4}$  tons of fine silver of 98 to 98·3 per cent.

### Refining in Crucibles.

This mode consumes less fuel than the refining process under the muffle, and causes less loss of silver, and also yields a more uniform fine silver, but it only permits a small production, and it causes loss by breakage of the crucibles; for this reason it is only used in a few smelting works.

It has been in use at Pontgibaud\* since 1849. The brightened silver is melted in plumbago crucibles, 0·3 metre high, and respectively 0·18 and 0·09 metre wide at the top and bottom, with an addition of saltpetre and quartz. The air furnace is 0·5 metre in section, 0·6 metre deep, from the grate to the mouth; the chimney is 5 metres high, and 0·5 by 0·15 metre in section.

The crucible surrounded by glowing coals and coke, is

\* B. u. h. Ztg., 1851, p. 379.

gradually charged with 38 or 40 lbs. of silver, with an addition of 1 lb. of saltpetre and quartz; the mass will be fused in about 1 hour, and the process finished in  $1\frac{1}{2}$  hours. The dross which is formed is removed, and an addition of saltpetre and quartz will show whether new dross (oxide and slags) will be formed; if such is not the case, the contents of the crucibles are poured out into cylindrical moulds; the resulting silver is of 0.997 fineness.

Of late the silver has been melted, without any addition, and as quickly as possible, in order to render it more homogeneous.

A similar process is carried on in Vialas\* with brightened silver which has been brought to a moderate fineness in the cupelling furnace; this causes a greater loss of silver, but the subsequent melting with quartz is cheaper.

At Arany-Idka (Upper Hungary), the silver resulting from the amalgamation process is melted in cast iron crucibles, 24 inches high and 28 inches wide, furnished with a clay lid; carbonate of potash, saltpetre, and sulphate of soda being added.

#### The Extraction of Silver from Rich Lead by means of Zinc.

According to Parkes,† argentiferous lead may be desilverised by fusing it with zinc; when the metals are well stirred together, and afterwards allowed to remain quiet for some time, the zinc will rise to the surface, and will be found to contain nearly all the silver. The argentiferous zinc is now skimmed off, or allowed to become solid and form a crust; this may be raised and separated from the lead, and then treated for its silver, which may be obtained in a pure state. The separation of the zinc from the silver is effected either by distillation or by a treatment with muriatic or sulphuric acids. The argentiferous residue may be purified by cupellation. The desilverised lead may be purified from zinc by refining in reverberatory furnaces.

Though this mode permits a complete desilverising of the

\* Ann d. min., iv., 121.

† DINGL. polyt. Journ., Bd. 119, p. 466. Bgwksfd., xv., 653.

lead, it was relinquished on account of the difficulty in treating the alloy of lead and zinc.

Very rich lead cannot be completely desilverised in one operation by this method, and a combination of Parkes' and Pattinson's processes might perhaps be suitable for it. The former process will extract a great part of the silver, and the latter will at the same time enrich and purify the poor lead.

According to Nevill,\* who has compared both methods, a much greater quantity is extracted by Parkes' process, and he states that the loss of lead amounts to 1 per cent, and that of zinc to 3-5ths of the quantity employed.

The quantity of zinc to be added depends on the amount of silver contained in the lead, and also on the foreign impurities present (sulphur, arsenic, antimony, &c.), which then combine in great part with the zinc.

This process was carried out at the works of Messrs. Nevill,† at Llanelly, as follows:—

About 6 tons of lead, containing about 14 ozs. of silver per ton, are fused in an iron pan like that used in Pattinson's process; into this about 1 per cent of fused zinc is poured, and four men stir the fluid metal for one or two hours. The fire is then lowered, and the mixture allowed to rest for some time until a scum forms; this scum is removed with a ladle pierced with a number of holes.

When the crust ceases to form, the lead is run off into a reverberatory furnace, and heated in a flat pan, to allow the zinc that may have remained in it to volatilise or oxidise; when this treatment has been sufficiently prolonged, it is run into an iron pot, stirred with a stick of green wood to bring about a still more perfect oxidation, and then cast into moulds for sale.

The scum taken from the pot is partly purified from the lead with which it was mixed, by heating in an inclined iron retort. The lead that runs out of this zinc contains about 1,000 ozs. of silver to the ton, and is ready for cupellation; the residue in the retort is transferred to clay pots, and the zinc distilled from it. The residue consists of silver mixed

\* ERDMANN'S Journ. f. pr. Ch., lxvii., 257.

† B. u. h. Ztg., 1852, p. 1. ERDMANN'S Journ. f. pr. Ch., xii., 257.

with much antimony, lead, copper, arsenic, nickel, &c.; this is fused with lead and cupelled for its silver.

At Tarnowitz\* (Hungary), experiments were made to desilverise raw lead containing  $1\frac{1}{2}$  or 2 ozs. of silver by this method, and  $1\frac{1}{2}$  per cent of zinc was required to effect this desilverisation; the remaining lead contained 0.008 of an oz. of silver. The desilverisation of the zinc was effected by distillation in muffles; the cost for 5 tons of raw lead treated by this method amounted to about £2, and the cost of cupelling the same quantity to about £6.

#### B. EXTRACTION OF SILVER IN THE WET WAY.

To extract silver from ores or products by the wet way it must be converted—

1. Into chloride of silver, from which the silver may be extracted by mercury (amalgamation); or the chloride of silver is dissolved in a solution of common salt and precipitated by copper (Augustin's process); or the chloride of silver is dissolved by hyposulphite of soda, and the silver thrown down as a sulphide by polysulphide of sodium (Patera's method).

2. The silver is dissolved as a sulphate and precipitated by copper (Ziervogel's process).

3. The argentiferous product is treated with dilute sulphuric acid, and the silver extracted from the argentiferous residue either by fusion with lead or in the wet way (extraction by means of sulphuric acid).

The choice between these different processes depends chiefly on the composition of the substances under treatment, whether they contain more or less lead, antimony, arsenic, and zinc.

##### 1. Extraction of Silver by means of Mercury (Amalgamation).

This process† is based upon the property which mercury possesses of forming an alloy or amalgam with silver which decomposes when heated, the mercury being volatilised,

\* KARSTEN'S Archiv., 2 R., xxv., 192. B. u. h. Ztg., 1852, p. 828.

† KARSTEN'S Archiv., 2 R., i., 161.



while the silver remains as a residue. It was first introduced into Mexico by Bartholomé de Medina in the 16th century, as the smelting processes could not be carried out on account of a scarcity of fuel; the ores are treated in heaps without the application of a high temperature (*American system of amalgamation in heaps*).

In 1784, Born, an Austrian mining officer, brought this process into Europe, conducting the amalgamation in copper pans. Gellert afterwards employed stationary casks, and at Freiberg Ruprecht first performed this process in rotating casks (*European system of amalgamation in casks*). In order to facilitate the process, it is partly carried on with the application of a higher temperature.

In both methods the silver contained in the ores is first converted into chloride of silver (in the European system by roasting with common salt, and in the American by treating the ores at the common temperature with chlorides), the chloride of silver is decomposed in the European method by iron, and in the American method direct by mercury; the liberated silver is then seized upon by the mercury, the amalgam is heated, and the remaining silver refined.

The European system of amalgamation is preferable, as it extracts the silver quicker and more perfectly, causing from 8 to 12 times less loss of quicksilver; yet the American plan is still frequently carried out in America in places where quicksilver is cheap, fuel wanting, salt expensive, and machinery not easily obtainable; the climatic conditions of South America also assist the chemical reactions.

To lessen the loss of silver occasioned by roasting, the two processes have been so combined that the transformation into chloride may take place at the common temperature, and casks are employed for amalgamation.

If the silver ores contain much gold it is advisable to treat them in amalgamation mills or pans at a higher temperature without roasting, by adding decomposing agents (potash, acids, &c.)\*

\* B. u. h. Ztg., 1861, p. 207; 1862, p. 83. WINKLER, die Europäische Amalgamation der Silbererze. Freiberg: 1848.

**European Process of Amalgamation in Casks.**—This method of extracting silver consumes less time than fusion with lead, and allows a saving of fuel, a quicker and more complete extraction of the silver, a better control of the process, and is cheaper if the price of quicksilver is not very high. On the other hand, the process of amalgamation requires for treatment ores and products free from certain noxious substances, and copper and gold, if present in the ores, are partly lost in the process; this prevents its being as generally applied as the fusion process with lead. Lately, also, other processes have been substituted for it.

According to Rösner,\* gold in auriferous and argentiferous ores forms a double salt,  $Au_2 Cl_3, NaCl + NaCl$ , which combination is slightly soluble in a solution of common salt, somewhat more so if protochloride of iron be present, but not at all if basic chloride of iron is contained in the solution; it is also undecomposable by quicksilver. Winkler† obtained from auriferous silver ore by the amalgamation process auriferous silver containing 0·05 per cent of gold, whilst the same ore treated by the fusion process yielded silver containing 0·14 per cent of gold.

Janikovits‡ states that by roasting auriferous ores with common salt, chloride of gold is formed, which is reduced by an increased temperature (200° C.) to sub-chloride, and by a temperature of 240° C. to metallic gold.

The process of amalgamation is used for ores, matts, speiss, and black copper.

### Amalgamation of Silver Ores.

The ores must be as free as possible from *lead, bismuth, copper, gold, nickel, and cobalt*, as the first three metals partly combine with the amalgam, and are therefore lost; they also form a tough amalgam which is separated from the residues with difficulty, but renders it richer. These metals chiefly remain in the residues, and can only be extracted by a smelting process.

\* Oesterr. Ztschr., 1863, Nos. 25, 40. B. u. h. Ztg., 1863, p. 336.

† WINKLER, die Amalgamation., i., p. 46. Freiberg: 1848. B. u. h. Ztg., 1861, p. 208.

‡ Ibid., 1861, p. 325.

The presence of lead and bismuth renders the roasting difficult by an inclination to cake; a larger amount of antimony and arsenic increases the volatilisation of silver in the roasting process, and zinc blende has a similar action.\* Quartz, heavy spar, and earthy silicates do not interfere at all; calc spar, brown and fluor spar are transformed by the roasting process into sulphates; siliceous and calcareous ores give better results combined, than by themselves; aluminous ores are more difficult to amalgamate.† Pyritic Dürr ores are best adapted for the process if they contain a sufficient amount of pyrites for decomposing the salt in the roasting process, otherwise such fluxes as pyrites, raw matt, or sulphate of iron must be added. If the ores contain too much pyrites, they have to be previously roasted until they contain no more than sufficient sulphide of iron; the residues of ores containing a larger amount of silver will be too rich.

The amalgamation process requires the following manipulations :—

1. **Pounding the Ore.**—The finer the ore is pounded the quicker and more perfect will be the transformation of its silver into chloride by the roasting process; the ore is therefore generally ground and passed through a fine sieve.

2. **Mixing the Ores.**—Siliceous, calcareous, and aluminous ores are mixed in such proportions that the mass contains the proper amount of silver and of sulphides; this is then thoroughly mixed with from 10 to 12 per cent of common salt. In Freiberg they use two different mixtures, a rich one and a poor one, the rich containing from 0·24 to 0·26 per cent of silver, and from 22 to 24 per cent of sulphides of iron, and the poor from 0·09 to 0·1 per cent of silver, and from 24 to 26 per cent of sulphides.

3. **Roasting the Ore.**—The ores are roasted in charges of about 5 cwts. in reverberatory furnaces with either one or two hearths, and provided with condensation chambers. They are spread out upon the hearth, and dried with repeated turnings over at a dull red heat till the decrepitation of the

\* Freiburger Jahrbuch, 1850, p. 140.

† DINGLER'S Polyt. Journ., Bd. 115, p. 279.

salt ceases; the caked parts are then crushed with a hammer, and the fire is raised so as to burn the sulphur and keep the ore red hot for about two hours, during which time dense greyish-white vapours of arsenic, antimony, and water are exhaled.

A blue flame next shows the commencement of desulphuration or oxidation, by which the sulphides, the antimony, and arsenic are mostly transformed into salts, part of them also into free oxides. This continues for about two hours, during which time the ignition is kept up, and the mass is thoroughly turned over in order to present new surfaces, and prevent caking. When sulphurous acid ceases to be formed, the final calcination must be commenced with increased firing, the object now being to decompose the salt by means of the metallic sulphates which have been generated, and to convert them into chlorides, with the simultaneous production of sulphate of soda. The stirring is to be continued till the samples drawn from the hearth no longer smell of sulphur, but only of hydrochloric acid. The roasting mass will then have assumed a woolly appearance. This stage of the roasting commonly lasts  $\frac{3}{4}$  of an hour.

The fuel (Freiberg) of the first firing is pit coal; of the final one, fir-wood. On an average 115 $\frac{1}{2}$  cubic feet of pit coal and 294 $\frac{1}{4}$  of fir-wood are consumed for every 5 tons of ore.

During the last roasting the ore increases in bulk by one-fourth, and consequently becomes a lighter powder, and of a brown colour. When this process is completed the ore is raked out upon the stone pavement, allowed to cool, and then sifted in close boxes, in order to separate the finer powder from the lumps, which are to be broken up, mixed with salt, and subjected to another calcination; the finer powder alone being taken to the mill. (The stones at Freiberg are of granite, and make from 100 to 120 revolutions per minute). The roasted ore, after it has passed through the bolter of the mill, must be as impalpable as the finest flour.

4. **The Amalgamation.**—Fig. 94 shows the amalgamation machinery used in the works near Freiberg, which furnish the best model of the European system of amalgamation.

FIG. 94.

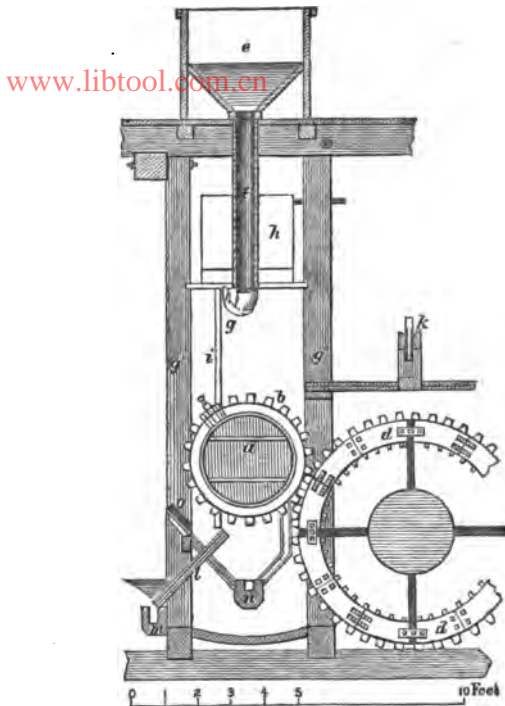

*a*, is a cask in which the amalgamation is performed; it is 2 feet 10 inches long, 2 feet 8 inches wide, measured inside, and is provided with iron ends. The staves are  $3\frac{1}{2}$  inches thick, and are bound together with iron hoops. It turns upon a shaft which passes through its axis, and can be made to revolve by the cog-wheel, *b*. It has a double bung-hole, one within the other, secured by an iron plug fastened with screws. It is filled by means of a hopper (*e*) in the second story of the building, which is provided with the proper quantity of ore, and by means of the hose (*g*) the powder falling through the pipe (*f*) is conveyed directly into the cask. The box (*h*) holds water, which can be readily carried by the tube (*i*) into the cask. *k*, is a tube connected with a reservoir by which the mercury is introduced. At the end of the process the cask is turned so as to have the bung downwards;

a tube (*l*) is attached to the opening, and the amalgam allowed to run into the trough, *m*. The remainder of the contents are then emptied into the trough, *n*. *d*, is a driving wheel by means of which the cask is set in motion.

Fig. 95 presents a vertical section of the Freiberg\* works,

FIG. 95.

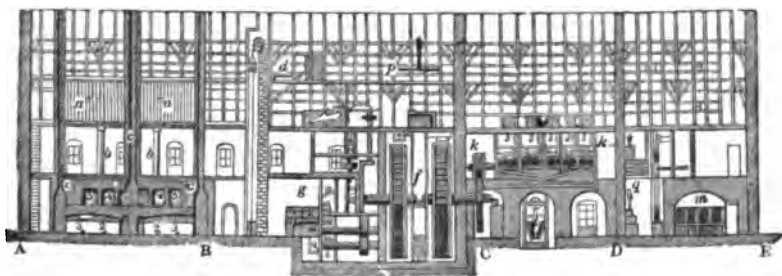

subdivided into four main departments. The first, A, B, is devoted to the preparation and roasting of the matter intended for amalgamation. The second, B, C, is occupied with the successive siftings and the milling. The third, C, D, includes the amalgamation-room and the wash-house of the residues below. And in the fourth, D, E, the distilling apparatus is placed, and there the amalgam is finally delivered.

Thus, from one extremity of this building to the other, the workshops follow in the order of the processes; and the whole length of 180 feet seems to be a laboratory, through which the materials pass, as it were of themselves, from their crude to their refined condition; the works are remarkable for the skilfully economised, and methodical labours of the workmen, and the regularity, precision, and facility which pervade the long series of combinations, movements, and metamorphoses of matter.

The following points require notice:—1. In division A, B, *a, a*, is the magazine of salt; *b, b*, is the hall for the preparation of the ores, on the floor of which they are sorted, interstratified, and mixed with salt; *c, c*, are the roasting furnaces; in each of which we see,—1, the fire-place; 2, 3,

\* Dr. URE'S Dictionary of Arts, &c., vol. iii., p. 666. London: 1867.

the reverberatory hearth, divided into two portions, one a little higher than the other, and more distant from the fire-place, called the drier. The materials to be calcined fall into it through a chimney, *b*. The other part (2) of the hearth is the calcining area. Above the furnace are chambers of sublimation, 4, 5, for condensing any volatile matters which may escape by the opening, 7; *e*, is the main chimney.

2. In the division, B, C, we have *d*, the floor for the coarse sifting, and beneath it that for the fine sifting; from this the matters fall into the hopper, whence they pass down to *g*, the mill-house, where they are ground to flour exactly as in a corn-mill, and are afterwards bolted through sieves; *p*, *f*, is the gearing of the mill.

3. The compartment, C, D, is the amalgamation house, properly speaking, where the casks are seen in their places. The washing of the residues is effected in the shop, *l*; below (*k*, *k*) is the compartment containing the revolving casks.

4. In the division, D, E, the distillation process is carried on; there are four similar furnaces; *g*, is a store chamber.

At B, are placed the pulleys and windlass for raising the roasted ore to be sifted and ground; also for raising the milled flour to be transported to the amalgamation casks; at D, stands the crane for raising the iron bells that cover the supports which, on account of their shape, are called *candelabra*.

Veatsch\* has constructed stationary casks for amalgamation, and inside them iron or copper plates are moved round by means of a vertical axis; the bottom of the cask is pierced with holes for admitting steam. These casks require little space and little motive power, and one of them is said to effect as much work as 6 horizontal casks, each of 10 cwts. charge.

The amalgamation may be divided into the following three periods:—

*a*. Each cask is charged first with 1 cwt. of iron,  $1\frac{1}{2}$  inch square and  $\frac{3}{8}$  thick, or in the form of balls; then about 3 cwts. of water (at Arany-Idka this is previously warmed

\* B. u. h. Ztg., 1863, p. 107.

to 20° C.) are poured in, and from 10 to 14 cwts. of the bolted ore flour are introduced. The casks being two-thirds full, are made to revolve for two hours, making 10 or 12 turns per minute, till the ore powder and water have become of a uniform paste. As soon as this is the case, there follows :—

b. The second period, that of amalgamation. From 3 to 5 cwts. of mercury are poured into each cask ; they are then made tight and are put in gear with the driving machinery, and are kept constantly revolving for 18 or 20 hours, at the rate of from 20 to 22 turns per minute. During this time they are twice stopped and opened, in order to ascertain if the paste be of the proper consistence, for if it is too thick, the globules of mercury do not readily combine with the particles of ore, and if too thin, they fall and rest on the bottom. In the first case, some water must be added ; in the second, ore. If the dispersed quicksilver shows a greyish black colour, more iron is added ; and the velocity of the casks is increased if the quicksilver appears as a white powder. The reaction between the iron, mercury, and silver ores causes the temperature to rise, so that even in winter it sometimes stands as high as 104° F.

The chemical changes which occur in the casks are as follows :—

The metallic chlorides present in the roasted ore are decomposed by the iron, whence results chloride of iron, whilst the chloride of copper is reduced partly to sub-chloride and partly to metallic copper, which then precipitates metallic silver. The mercury dissolves the silver, copper, lead, antimony, &c., forming a complex amalgam. If the iron is not present in sufficient quantity, or if it has not been worked with the ore long enough to convert the chloride of copper into sub-chloride, previous to the addition of the mercury, more or less mercury will be wasted by its conversion into calomel. Chlorides of manganese, zinc, nickel, and cobalt, are not transformed, and may be afterwards precipitated from the solution by lime ; only half the gold contained in the ore is extracted by this process. If many foreign chlorides are contained in the mass in consequence of too low a temperature



during the roasting process, some lime may be added to decompose them. When the ores are very rich in copper, copper is added instead of iron, as iron causes the formation of an amalgam rich in copper (Mexico).\*

c. As soon as the amalgamation is complete, the casks must be filled with water, made to revolve slowly (about 6 to 8 times a minute), by which in an hour, or an hour and a half at most, a great part of the amalgam will have collected at the bottom, and in consequence of the dilution, the small amount of chloride of silver, held in solution by the salt, will fall down and be decomposed. Into the small plug in the centre of the bung a tube with a stopcock is now to be inserted, to draw off the amalgam into its appropriate chamber. The tap must be turned whenever the brown muddy residue begins to flow. The main bung being then opened, the remaining contents of the casks are emptied into the *wash-tun*, while the pieces of iron are kept back. The residuary ore is found to be deprived of its silver to within 0·15 to 0·17 of an ounce per cwt.; 160 tons of ore are amalgamated in 14 days. For working 5 tons of ore, 14½ lbs. of iron are required; and for every pound of silver obtained, 3 ozs. of mercury are consumed.

Experiments have been made to conduct the amalgamation process in iron casks, heated to 150° or 160° F. over a fire; but though the desilverising was more complete, the loss of mercury was so much greater as to more than counterbalance that advantage.

5. **Treatment of the Residues.**—When passing from the casks and along the trough to the wash-tun, the residues are continually stirred, so that the small grains of amalgam with which they are mixed may fall to the bottom and be collected; residues containing gold and silver are treated by some smelting processes.† The liquid from the residues is collected in a reservoir and concentrated, and the sulphate of soda contained in it extracted by crystallisation (Arany-Idka).

\* B. u. h. Ztg., 1860, p. 487.

† B. u. h. Ztg., 1848, pp. 628, 649; 1849, p. 180. ERDMANN'S Journal, xix., 118. Freiburger Jahrbuch, 1848, pp. 78, 80.

**6. Treatment of the Amalgam.**—The amalgam is first washed with water in suitable vessels, and then in a moist canvas bag, through which the thin uncombined quicksilver passes spontaneously; the bag is then tied up and subjected to pressure (this is the oldest method used in Freiberg). A more complete separation of the uncombined mercury may be effected by allowing the amalgam to settle in a narrow wooden tube, about 8 feet high, previous to its treatment in the canvas bag; the mercury will collect in the bottom of the tube, and the amalgam, being specifically lighter, will float upon it. In Arany-Idka a machine is used for this separation, which consists of a cylindrical wooden vessel, into which a hollow cylinder of perforated iron-plate is fitted; the amalgam being put into a bag of fustian is pressed in the hollow cylinder by means of a screw. At Poullaouen the amalgam is treated by hydraulic pressure in an iron cylinder furnished with a bottom of beech-wood, through which the quicksilver is forced.

If plumbiferous silver amalgam\* is squeezed at a temperature of 80° to 100° C., the lead amalgam will go with the mercury, whilst the silver amalgam will remain in the bag. If the plumbiferous mercury is pressed after having cooled, the lead amalgam will remain, whilst only mercury will pass through the bag.

In Freiberg from 3 to 3½ cwts. of solid amalgam are thus procured from 20 casks, usually consisting of 1 part of an amalgam containing from 75 to 81 per cent of silver, and 6 parts of quicksilver; the foreign metals in the alloy are copper, lead, gold, antimony, cobalt, nickel, bismuth, zinc, arsenic, and iron; moreover, the filtered quicksilver contains 1 or 1½ ozs. of silver in the cwt.

**7. Distillation of the Amalgam.**—The apparatus† used for distilling the amalgam in the Halsbrücke works, near Freiberg, is represented by Fig. 96—*a*, is a wooden drawer, sliding in grooves upon the basis, *g*; *B*, is an open basin or box of cast-iron, laid in the wooden drawer; *y*, is a kind of iron

\* B. u. h. Ztg., 1863, p. 7.

† URE'S Dictionary of Arts, &c., vol. iii., p. 669. London: 1867.

FIG. 96.

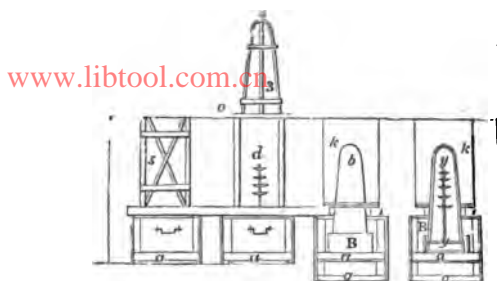

candelabrum, supported upon 4 feet, and set in the basin B; under *d*, are five dishes or plates of wrought iron, with a hole in the centre of each, by which they are fitted upon the stem of the candelabrum, 3 inches apart, each plate being successively smaller than the one below it. 3, represents a cast-iron bell, furnished with a wrought iron frame and hook, for raising it by means of a pulley and cord; *s*, is a sheet-iron door for closing the stove whenever the bell has been set in its place.

The box, *a*, and the basin B, above it, are filled with water, which must be continually renewed through a pipe in the side of the wooden box, so that the iron basin may always be kept submerged and cool. The drawer (*a*) being properly placed, and the plates under (*d*) being charged with balls of amalgam (weighing altogether 3 cwts.), the bell (3) is let down into the water, as at *y*, and allowed to rest upon the lower part of the candelabrum. Upon the ledge (*x*) which represents the bottom of the fire-place, a circular plate of iron is laid, having a hole in the middle for the bell to pass through. Under this plate chips of fire-wood are kindled, then the door (*s*) which is lined with clay, is closed and luted tight. The fuel is now placed in the vacant space (*k*) round the upper part of the bell; the fire must be fed very gradually, first with turf, then with charcoal; as soon as the bell becomes red, the mercury volatilises, and condenses in globules in the bottom of the basin B. After eight hours the fire is stopped, provided no more drops of mercury are heard to fall into the water. When the bell has cooled, it

is lifted off; the plates are removed from the candelabrum (*d*); and this being taken out, the drawer is slid away from the furnace.

The mercury is drained, dried, and returned to the amalgamation works.

The silver, which is more or less pure, and has a cauliflower-like appearance, is fused and refined by cupellation.

The water used is passed through reservoirs.

This mode of distilling the amalgam requires much time and fuel, and does not effect a perfect separation of the mercury; also frequent cracking of the bells causes a loss of quicksilver, and there is no way of knowing the end of the operation but by experience; therefore it has in most places been superseded by the process of distilling in retorts, as consuming less fuel, causing less loss of mercury, and permitting the operation to proceed better.

The apparatus used in Arany-Idka is represented by Fig. 97. The retort consists of two parts—the crucible, *b*, and the

FIG. 97.

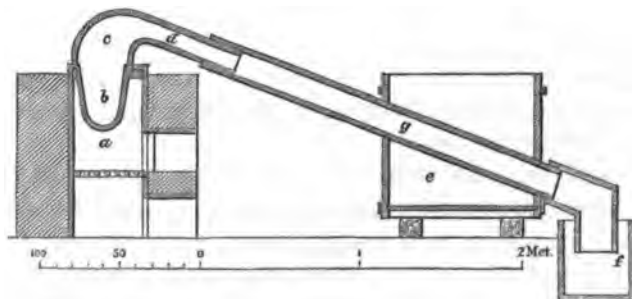

capital and neck, *c* and *d*, which are screwed together. The crucible is 11 inches deep and 22 inches wide at the mouth. The retort is connected with a refrigerator, *e*, by the conducting tube, *g*, and the condensed mercury drops into *f*. The crucible is furnished in the middle with a piece of plate iron (divider) which exactly fits the inside of it, causing one half of the silver to cake on one side of the plate, and the second half on the other; the whole may then be drawn out together by the plate. Both the plate and the crucible are previously coated with lime.

The crucible is charged with 4 cwts. of amalgam, and a slow fire is made in order to avoid a formation of finely divided mercury, and to prevent much silver being carried along with the mercury. The fire is not increased until the mercury begins to distil with a rushing noise. At last the temperature is raised to a red heat; the process takes about 5 hours, consuming 12.9 cubic feet of charcoal for every cwt. of distilled mercury.

At Arany-Idka, in Hungary, in 1861, 1,050 tons of ore flour, containing 2624.4063 lbs. of silver, were treated by the amalgamation process. They were roasted in 4 reverberatory furnaces, each with two hearths, in 2,055 shifts of 12 hours, at a cost of £110 12s.; the cost of grinding and sifting the ores amounted to £97 16s. The ore was amalgamated in 1,751 casks at a cost of about £477 4s., and yielded 15½ tons of amalgam, containing 2632.422 lbs. of silver. The amalgam, after having been pressed, contained 85 or 86 per cent of mercury, 9 or 10 per cent of silver, and from 4 to 6 per cent of copper, iron, antimony, and lead. It yielded by the distilling process 2¼ tons, 93 lbs. of silver, and 13½ tons, 77½ lbs. of mercury; the loss of mercury, therefore, amounted to 0.95 per cent. By fusing those 4394.2527 lbs. of silver, 4286.8223 lbs. of raw silver, containing 2632.9762 lbs. of fine silver, were produced.

The total cost for 1861 amounted to £2,456 6s., and per lb. of silver, to 18s. 4d. 23.25 cubic feet of wood were consumed for roasting and amalgamating 5 tons of ore flour, and 310¼ tons of mercury were used for 1,050 tons of ore flour; the loss of mercury amounted to 0.225 oz. per cwt. of ore, and to 1.815 ozs. per lb. of silver. The consumption of iron was 1.465 ozs. per cwt. of ore, and 11.68 ozs. per lb. of silver; the consumption of salt was 16 per cent of the ore, the latter containing from 15 to 18 per cent of sulphides. If the percentage of sulphides increases, the consumption of salt may be lessened, as more sulphuric acid will be formed, causing a more perfect separation of chlorine. A surplus of salt is generally advisable to avoid a formation of silicate of silver which is likely to take place in the roasting process, and to convert the greater part of the silver into chloride. Such a

surplus of salt at Arany-Idka, in the years 1860 and 1861, caused the residues to contain only 0.004 per cent of silver.

Roeszner's method of extracting silver and gold\* has been lately substituted for the amalgamation process.

At Huélgoet,† ores with from 0.9 to 1.7 ozs. of silver in the cwt. are roasted for 4 hours with 5 per cent of sea salt, then treated in the cask with iron for four hours, and for 24 hours with mercury. One cask contains 740 lbs. of ore flour and sea salt, 60 lbs. of mercury, and 80 lbs. of iron. The distilling of the amalgam is effected in a retort, and the resulting silver contains 30 per cent of silver, besides some copper, iron, tin, and mercury; 1 cwt. of residues contains 0.08 oz. of silver, and the loss of mercury amounts to 0.9 oz. per cwt. of ore.

The most extensive amalgamation works in Europe‡ are probably those of La Bella Raguel, where the ores obtained from the mines of Hiendeleucina, situated in the province of Guadalajura, Spain, are chiefly washed in revolving apparatus, and are subsequently treated in barrels, sixty of which are employed.

The European amalgamation is also carried out at Arivaca,|| in Mexico, for treating argentiferous copper ores containing 25 or 30 per cent of silver and from 15 to 70 per cent of copper. They are roasted with an addition of common salt and from 3 to 5 per cent of lime (to prevent a formation of chloride of copper); they are then treated in revolving casks, first with water and copper, and afterwards with mercury. The loss of mercury amounts to 7 or 8 ozs. per lb. of silver; the loss of silver during the roasting process is sometimes as much as 15 per cent.

### Amalgamation of Argentiferous Matt.

Matt, with the exception of copper matt, is treated like ore. It is first roasted by itself, and afterwards mixed with salt, lime, and water; when dried it is again roasted. The

\* Oesterr. Ztschr., 1863, No. 40. B. u. h. Ztg., 1863, p. 428.

† Rivot, *Traité de Métallurgie*, 1860, i., pp. 652, 676. B. u. h. Ztg., 1859, p. 351.

‡ *URE's Dictionary of Arts, &c.*, vol. iii., p. 669. London: 1867.

|| B. u. h. Ztg., 1860, pp. 487, 498.

addition of lime is made in order to decompose the chlorides which might be formed by the roasting process, and which would otherwise cause the formation of calomel in the amalgamation process; lime, therefore, lessens the loss of mercury, but, on the other hand, it may act disadvantageously on the yield of silver, as oxide of silver will probably be precipitated by lime if sulphate of silver is present.

### Amalgamation of Speiss.

Speiss is first roasted by itself, and afterwards with salt; at this last roasting an addition of sulphate of iron is given to liberate the chlorine, if sufficient sulphur in form of matt is not left in the speiss when producing it. If the speiss contains too little matt the roasting process will cause great loss of silver, and if it contains an excess of matt, a separation of basic iron salts will take place, causing a large consumption of iron and copper, as well as mercury, during the amalgamation. If the roasting process is not very carefully carried on, a great loss of silver may be occasioned by too high a temperature, causing part of the arseniate of silver to be reduced to metallic silver, which is then volatilised partly as oxide and partly as chloride, together with other metallic chlorides. An addition of lime is made to the roasting and amalgamating of the speiss in order to counteract the formation of metallic chlorides, and copper is used instead of iron to prevent the formation of a cupriferous amalgam.

At the Stephanshütte,\* in Upper Hungary, copper speiss, containing 25 per cent of copper, 0.28 per cent of silver, 58 per cent of antimony, 8 per cent of iron, 5 per cent of sulphur, 2 per cent of arsenic, a little bismuth, lead, cobalt, and nickel, and a small amount of gold, is amalgamated. It is first roasted in quantities of 5 cwts. with 2 per cent of limestone, for 5 hours on the upper hearth, and for the same time on the lower hearth of a Hungarian roasting furnace. It is then ground and sifted, and after being mixed in lots of 6 cwts. with 1 per cent of limestone and 7 per cent of salt, is well roasted for 6 hours on the lower hearth of the furnace.

\* Oesterr. Ztschr., 1857, p. 145; 1861 No. 12. B. u. h. Ztg., 1862, p. 18.

When the roasting mass has cooled it is again mixed with 1 per cent of limestone, and finely ground. Twelve cwts. of this ore flour mixed with 2 per cent of salt are formed into a paste by intimately mixing them with about 90 gallons of a hot solution of salt and 7 gallons of lime white, and put in a cask together with 1 cwt. of copper balls; the cask is then set to revolve for 5 hours at the rate of 25 revolutions per minute. Four cwts. of mercury are now added, and the turning is repeated for 15 hours, at the rate of 18 revolutions per minute; the resulting amalgam is squeezed in a hydraulic press, and yields  $1\frac{3}{4}$  per cent of a granular amalgam containing 18 per cent of silver.

The mixture yields 97.7 per cent of its contained silver with a loss of 0.94 oz. of mercury per cwt. of raw ore flour, and a consumption of 0.053 per cent of copper.

The residues are heated in a roasting furnace with 2 per cent of pyrites and 5 per cent of salt; the gold contained in them is extracted by treatment with hyposulphite of lime; the cupriferos residues are treated with a solution of chloride of iron to dissolve the copper, which may then be precipitated by iron.

### Amalgamation of Black Copper.

When finely divided argentiferous black copper is heated with an excess of salt, chloride of silver and protochloride of copper are formed; the chloride of copper then transforms metallic silver into chloride of silver, becoming itself reduced to subchloride of copper.

The amalgamation of black copper is advantageous, as it admits of a quick extraction of the silver, and of the production of poor residues which do not require a farther treatment for such extraction. The residues obtained by Augustin's method are quite as poor, but the reduction of the precipitated silver by this process is more difficult than by the amalgamation process. Recently the amalgamation of black copper has been superseded by another mode of extraction (Tajova\*).

\* WEHRLE'S Hüttenkunde, ii., 492.



Black copper free from lead and gold should be treated by amalgamation, and not by fusion, as amalgamation is cheaper and simpler, yielding a better copper poor in silver. The advantages are less marked when treating plumbiferous copper, and auriferous copper is best treated by the fusion process, as the yield of gold is greater.

At Schmöllnitz,\* in Hungary, black copper containing from  $5\frac{1}{2}$  to  $7\frac{1}{2}$  ozs. of silver, and 85 to 89 per cent of copper, is heated in a reverberatory furnace, stamped when hot, and afterwards brought to a very fine state of division by grinding and sifting. Lots of 4 cwts. with an addition of about 8 per cent of salt are roasted, and then re-ground and amalgamated. One cask is charged with from 12 to 15 cwts. of ground black copper, from 54 to 67 gallons of water, 1 cwt. of copper balls (instead of iron), and 4 cwts. of mercury.

The loss of silver amounts to  $4\frac{1}{2}$  per cent of the quantity present,  $2\frac{1}{2}$  per cent of which remain in the residues, and about  $\frac{1}{2}$  ounce in the fine copper. The liquation process formerly used at Tajova for extracting the silver, caused a loss of no less than 27 per cent, 2 per cent remaining in the refined copper. Only two per cent of copper are lost, but 2 ozs. of mercury are lost for every cwt. of black copper.

Improvements resulting in a greater yield of silver have lately been made, by separating the black copper from the speiss present, by roasting the ground copper with salt for about nine hours, and by amalgamating it for 40 or 44 hours instead of 20 hours, and farther, by tapping off the amalgam after the casks have slowly rotated for 20 or 24 hours, and then adding fresh mercury.

At Offenbanya, in Siebenbürgen, black copper containing 10 per cent of lead is roasted for six hours, together with 12 per cent of salt, 1 per cent of ferrous sulphate, and 3 per cent of nitre, the latter to oxidise the lead. It is then ground, re-roasted, again ground, and amalgamated.

In 1830 the cost per lb. of silver was 3s. 9d. by the amalgamation process, and 18s. 11d. by the liquation process.

\* WINKLER, *Amalgam*, 1848, p. 154. *Oesterr. Ztschr.*, 1856, p. 129. *Annales des Mines*, 1855, 1 livr., p. 57. Bericht über die, 2. Versamml. d. Berg. und Hüttenmänner in Wien, 1862, p. 82.

At Cziklova, in Banat, ground black copper containing 0·681 ton of copper, and 3·48 lbs. of silver per ton, is roasted for 12 hours, in charges of 468 lbs., and mixed with 5 per cent of iron pyrites and 12 per cent of salt, causing a loss of 3 per cent of copper, and 7 per cent of silver; the cost of roasting 1 ton of black copper amounts to £1 8s. 9d. 1,344 lbs. of the roasting mass, with 50 lbs. of black copper, and some warm water, are allowed to rotate for half an hour, then 338 lbs. of mercury are added, together with some more water, and the casks put in motion for about 17 hours. The amalgam, after being squeezed in canvas bags by hydraulic pressure, contains 14 per cent of silver, and is distilled in a bell apparatus in quantities of 170 lbs.; this takes 8 hours. 170 or 180 lbs. of the resulting silver are refined on the test of a refining furnace. From 1 ton of black copper, 3·206 lbs. of fine silver, and 0·657 ton of copper are left in the residues, causing a loss of 7·8 per cent of silver, and 3·5 per cent of copper, and costing £3 5s. 6d.

The cupriferous residues are melted in cupola furnaces, together with 25 per cent of iron pyrites, and 6 per cent of charcoal powder, for the production of matt and black copper.

### The American System of Amalgamation in Heaps.

This system has the following advantages over other modes of desilverisation:—

*a.* It is least dependent on the locality, requiring almost no fuel and water, and but little machinery. All that is necessary for its accomplishment are:—Firstly, some machines for crushing the ore after it has been broken and dressed by hand; these machines are either crushing-rollers, or more generally stamps, called in Mexico, *molinos*; the stamps are similar in principle to those used in the Cornish tin mines, but less powerful, and are either worked by water power or by mules; Fig. 98 will give a sufficient idea of their construction. As the ore is crushed, it falls through small holes about the size of peas, which are perforated in strong hides stretched in a slope on either side of the machine, and placed over a pit to receive the fine ore, from whence it is

FIG. 98.

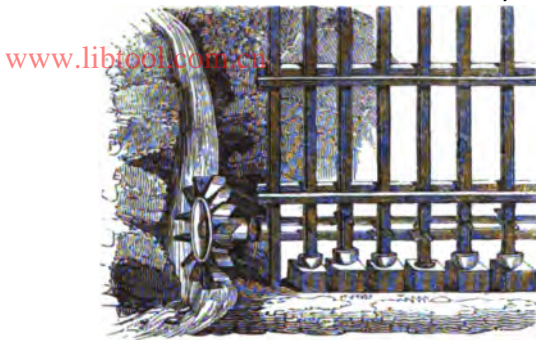

conveyed to the grinding mills (*arrastres*). They are generally moved by mules, and are usually arranged in rows in a gallery or shed, as will be seen by reference to Fig. 99, FIG. 99.

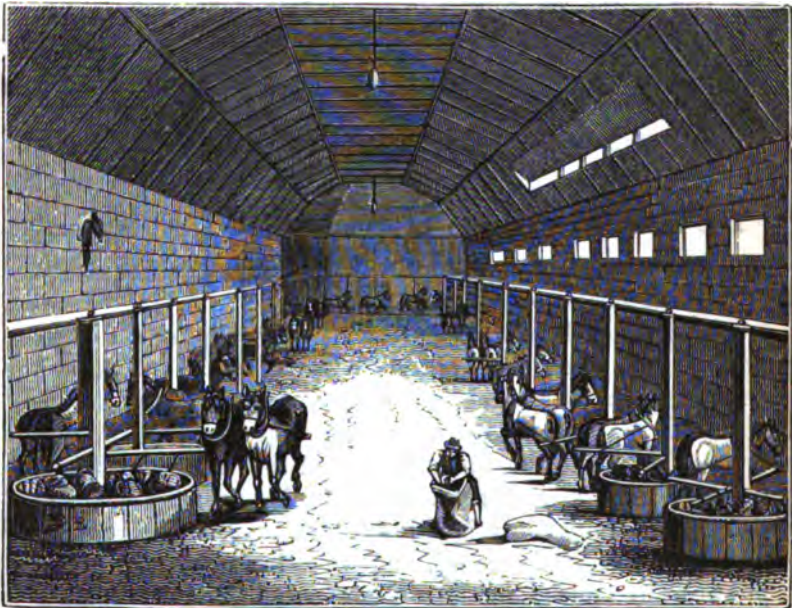

which represents the gallery of the Hacienda of Salgado. A machine has been introduced at Real del Monte, which has superseded the old Mexican *arrastres*; it is similar in principle to some of the grinding mills of this country, and to

the *trapiche* of Peru, consisting of two large circular edge-stones faced with iron, and moving over iron bottoms, the ore being washed and ground with water between the two metal surfaces. The machine is turned by twelve mules in the 24 hours, four mules working at a time, and the quantity ground to the state of fine slime is sixty quintals, or about ten times the quantity ground by a common arrastre; there is reason to believe that the quantity might be doubled by the use of water or steam power, as the number of revolutions would be increased. A *patio*, or amalgamation floor, is also required; in some places it is boarded, and in others paved with flat stones; the amalgamation in heaps is therefore called *beneficio por patio*. There are also required some distilling and washing apparatus, some rough roasting furnaces, &c.

The establishments maintained for extracting the silver from the ore are called *haciendas de beneficio*, or *haciendas de plata*; and there are many of great extent in the country. The *haciendas Nueva* in Fresnillo, *de Saucedo* in Zacatecas, *de Barrera* in Guanajuato, and *de Regla* at Real del Monte; are at present the principal establishments of the kind in use. That in Fresnillo is the largest in which amalgamation only is used, the outer walls being 1,360 feet long, by 1,140 feet wide. Its erection cost £75,000, and it is very complete in all its arrangements.

b. The silver is extracted comparatively quickly, and in a very fine state, requiring practical experience more than theoretical knowledge.

c. The consumption of all materials, chiefly of mercury, increases in proportion as more silver is contained in the ore, and is small if the ores are poor in silver. Ores containing no more than 0.04 to 0.05 lb. of silver per cwt. (2 ounces per carga\*) may be profitably treated by this method if they are otherwise fit for amalgamation.

On the other hand, this system has the following disadvantages compared with the amalgamation in casks:—

a. The yield of silver is more imperfect if the amount of

\* 1 carga = 300 lbs. avoirdupois.

silver in the ore reaches a certain limit, which is chiefly determined by the price of the materials and value of labour. In Mexico, ores containing more than  $\frac{1}{2}$  per cent of silver are mostly smelted with lead, and poorer ores are also treated by that process if they contain a larger amount of lead and copper.

*b.* The loss of mercury amounts to 22 or 24 ounces per lb. of silver, while at the amalgamation in casks the loss is only from 4 to 12 ounces, according to the quality of the ores and the manner the process is conducted. The large loss of 22 or 24 ounces is chiefly caused by the formation of chloride of mercury; its reduction alone causes a loss of 15 ounces.

*c.* Ores containing a larger amount of sulphides (iron and copper pyrites, or zinc blende) and little silver, cannot be profitably treated in patios, yielding only half of the silver present in the ores, and causing great loss of mercury; as the chloride of silver, as soon as formed, probably becomes transformed into sulphide of silver. A small amount of gold, which cannot well be extracted by either system, may be partly gained by adding some water and mercury at the grinding of the ores.

The finely ground ores are intimately mixed in heaps with salt, sulphate of copper (*magistral*), and mercury, and on the patio they are exposed for a longer time to atmospheric influence.

Mr. J. C. Bowring,\* who has had many years experience in the reduction of the ores of silver, both in Peru and Mexico, and has devoted much time and attention to an examination of the subject, disputes the received theory of the amalgamation process.

In reference to this subject he remarks :—

“ The theory of the chemical decomposition which takes place in the Mexican amalgamation process has hitherto been supposed to be that the bichloride of copper which is formed by the contact of magistral and common salt, abandons its chlorine to the silver, the sulphur of which combines with

\* URN'S Dictionary of Arts, &c., vol. iii., p. 664, London : 1867.

the copper, and the chloride of silver is decomposed by the mercury with which the precious metal becomes amalgamated. The following considerations, however, go to disprove this theory:—

1. Ores containing silver combined only with chlorine are considered by Mexican miners as those most difficult of reduction, and the loss of mercury caused by them is at least treble that experienced in those which contain only sulphides, and the process is much more tedious. To practical men, also, the appearance of the amalgams proceeding from these different combinations of silver when assays are taken out of the large ore heaps called *tortas*, is a convincing proof that the theories of their reduction cannot possibly be similar; in the case of chloride the quicksilver is instantly attacked, and its globules are very difficult to re-unite by friction, on account of their being covered with a thin coating of protochloride (calomel), whereas, when operating upon sulphides, the mercury is always bright (except at the very beginning of the process), and does not separate into globules, unless too large a quantity of magistral has been used, when the appearance is similar, though in a slighter degree, to that when chloride of silver has been reduced.

Various plans to diminish, or even entirely to do away with the loss of mercury, have been formed on the hypothesis that chloride of silver is formed, and that great advantages are derived from boiling ores containing this native combination, such as those of the district of Cartorce, in copper vessels, as the chloride is decomposed by the contact with the copper before the mercury is added, thus rendering the loss of mercury scarcely appreciable. Many of the plans proposed by European chemists have been successfully tried upon this class of ores, but all have invariably failed when attempting to reduce sulphides of silver by them.

2. Although the experience of M. Bossingault proves that a strong solution of the chloride of copper, mixed with a solution of salt and placed in contact with sulphide of silver, will after some time form chloride of silver and sulphide of copper; still this is practically useless, as in many instances a solution of less than one ounce of sulphate of copper



is required in 70 pounds of water, and even in the ores most difficult of reduction, the quantity is rarely more than eight ozs. Numerous experiments have been made in Mexico to bring this principle into practice, but after leaving the ore exposed for two months to the action of a mixed solution of chloride of copper and salt, there is rarely found a trace even of chloride of silver, and then, on adding the mercury, the process lasts as long as in ordinary cases, when it is put in before the sulphate of copper. The constant failure of these experiments proves that the theory on which they are founded must be fallacious.

Thus the presence of mercury being necessary, not merely as a means of collecting the particles of silver disseminated through the ore, but also as a chemical agent, the action of chloride of copper upon it must be considered. By this action, which is instantaneous, a sub-chloride of both metals is formed, and by absorbing oxygen from the atmosphere the sub-chloride of copper becomes converted into an oxychloride, which by giving up its oxygen to the sulphur combined with the silver, leaves the silver in a metallic state, and free to amalgamate with the mercury. This is proved by boiling native sulphide of silver with oxychloride of copper in a solution of common salt, when metallic silver will be obtained : or, as a more practical experiment, mix some rich ore with these materials and mercury at the ordinary temperature ; in about an hour the whole of the silver will have become amalgamated, when, after separating all the soluble salts by filtration, and adding chloride of barium, sulphate of baryta will be precipitated, equivalent in quantity to the sulphur which has become acidified, thus showing that the sulphuric acid can only have been formed by the decomposition of the sulphide of silver, and could not have been present if this metal had combined with chlorine according to the old theory.

The action of oxychloride of copper in the reduction of silver ores appears to be continuous, and thus offers some analogy to what takes place in the manufacture of sulphuric acid. By giving up its oxygen to the sulphur previously combined with the silver, the oxychloride of copper is converted into a sub-chloride, and this again into a chloride by

the action of the chlorine which is evolved by the decomposition of the salt when attacked by the sulphuric acid that has been formed. This chloride again is decomposed by the mercury, and first a sub- and then an oxy-chloride of copper is formed. The sulphur of the silver is acidified, and the action is continued in the same manner until the whole of the metal is amalgamated.

The imperfections in the Mexican amalgamation process arise chiefly from the small quantity of oxychloride of copper which can be employed ; for by using too large a proportion of sulphate the mercury becomes sensibly attacked, and unless its surface is perfectly clean it will not take up the particles of silver. The use of salt in the tortas has always been supposed to be that it dissolves the chloride of silver formed during the process, but its real object appears to be first to assist in the formation of the oxychloride of copper, and then to dissolve it, thus rendering it more capable of acting upon the sulphide of silver.

Von Uslar\* confirms Bowring's views, and denies that chloride of silver is formed. He supposes from experiments that by the reaction of mercury upon chloride of copper, chloride of mercury and sub-chloride of copper are formed thus :—

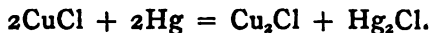

He further assumes that the sub-chloride of copper absorbs oxygen from the atmosphere, forming oxychloride—

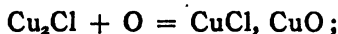

and that the oxychloride separates silver in a metallic state from the sulphide of silver—

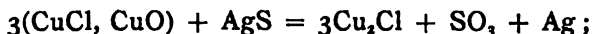

the silver then combines with the mercury.

Grütznert† entertains similar views. He supposes that chloride of copper in contact with mercury forms sub-chloride of copper and mercury—

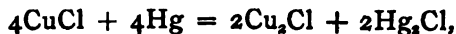

\* Bgwksfd., 1860, Bd. 1, Hft. 1. Berggeist, 1861, No. 49. B. u. h. Ztg., 1861, p. 406; 1862, p. 309; 1863, p. 5.

† B. u. h. Ztg., 1863, p. 108.



and that in contact with atmospheric air the sub-chloride becomes transformed into oxychloride—



but if an excess of mercury is present during the transformation, sub-oxide of copper will be formed instead of oxide of copper—

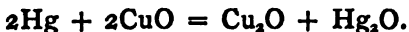

The sub-oxides of copper and mercury then react upon sulphide of silver as follows:—



The originally formed sub-chloride of mercury reacts upon the sulphide of copper, thus:—



Malaguti and Durocher\* also suppose that metallic silver is formed in the heaps.

Napier† tries to prove that chloride of silver can be formed in the experiments made by Bowring and v. Uslar, and that this chloride of silver can be again transformed into sulphide of silver by foreign sulphides, chiefly of lead, iron, and zinc, if present.

Gurlt‡ and Markus|| have proved experimentally that sulphide of silver may be transformed into chloride of silver by chloride of copper in the wet way.

Nolte§ supposes that mercury and sulphide of silver are transformed directly into silver and sulphide of mercury; this being facilitated by a galvanic action between the ore, mercury, and the liquid.

The Process of Amalgamation in Heaps is carried on as follows in Mexico¶ and Bolivia\*\* :—

\* MALAGUTI and DUROCHER über des Vorkommen und Gewinnen von Silber, Deutch von Hartmann, 1851, p. 119.

† B. u. h. Ztg., 1862, p. 310.

‡ Ibid., 1851, p. 692. KERL, Unterharzer Hüttenprocesse, 1861, p. 103.

|| Oesterr. Ztschr., 1854, p. 131.

§ B. u. h. Ztg., 1863, p. 83.

¶ Dr. URK's Dictionary of Arts, &c., 1867, vol. iii., p. 663. B. u. h. Ztg., 1856, p. 34; 1862, p. 266; 1863, pp. 2, 108. *Bullet. de la Soc. de l'Industr. Minér.*, ii., 310. *DINGLER'S Polyt. Journ.*, Bd. 115, p. 289.

\*\* B. u. h. Ztg., 1858, p. 290; 1859, p. 6.

The ore being brought by the grinding mills to a finely-divided state, is allowed to run out of the arrastre into shallow tanks or reservoirs, where it remains exposed to the sun until the greater part of the water has evaporated, when it assumes the appearance of thick mud; and in this state the process is proceeded with. Sometimes it is dried, and, for its further disintegration, gently heated in a reverberatory furnace for about 12 hours.

The *lama*, as it is called, or slime, is now laid out on the *patio*, or amalgamation floor, in smaller or larger masses, according to whether it is to be trodden by men or mules. Mules are generally used, and the large masses called *tortas* are 40 or 50 feet in diameter, and about a foot thick, frequently consisting of 60 or 70 tons of ore, and the floors are so extensive that a large number of these *tortas* are in progress at the same time. Thus, at the Hacienda de Regla, the patio, which is boarded and carefully caulked to render it water-tight, is capable of containing ten of these *tortas*, each of about 60 tons, and 50 feet in diameter. The Hacienda de Barrera, in Guanajuato, will hold 18 *tortas* of from 70 to 75 tons each; the Hacienda Saucedá at Zacatecas will contain 24 *tortas* of 60 tons each; and the patio floor of the Hacienda Nueva, at Fresnillo, is still larger, being 630 feet long, 630 feet wide, and capable of containing 64 *tortas* of 70 tons each.

The *lama* must be of a pasty consistence, but not so liquid as to flow. Then salt is introduced as the first ingredient in the proportion of  $1\frac{1}{2}$  to 5 per cent, according to the amount of silver contained in the ore. The salt is spread over the heap, and a number of mules are made to tread it, so that it may be taken up by the water, and intimately blended with the mass. After this treatment it remains untouched for about a day, when another ingredient is introduced, called in Mexico *magistral*. This is common copper pyrites, or sulphide of iron and copper, pulverised and calcined with an addition of salt, which converts it into sulphate. When of a good quality it should contain about 20 per cent of the sulphates of the two metals. From 1 to 2 per cent of this *magistral* is added in the *torta*, and the mules

are again made to tread the mass for several hours. Chemical action now commences; the salt, magistral, and metallic sulphides are decomposed, and new combinations are formed. Mercury is then introduced, being evenly spread over the torta in very small particles; this is effected by passing it through a leather or canvas bag; the quantity required is about 6 times the estimated weight of the silver contained in the ore.

The mercury being spread over the surface, the mules are once more made to tread the whole until it is well mixed. This treading is called the *repaso*, and is repeated every other day about 10 or 12 times, until, according to the judgment of the *azoguero*, or superintendent, the operation is completed.

It is in the progress of this operation that the skill of the *azoguero* is most required, as he must attend to certain signs or appearances upon which the success of his work depends, both as regards the produce of silver or the economy of mercury, other materials, and time. For this purpose he has a small quantity of the torta put on one side, upon which he operates before adding materials to the torta itself; this is called the *guia*, or guide. In order to ascertain how the chemical action in the torta proceeds, he collects a small quantity of the slime, and washes it in a small bowl, and by the appearance presented by the mercury and amalgam he is able to judge, from his practical knowledge of this subject, as to the state of the torta, whether it requires more magistral or mercury, or whether it has had too much magistral, in which case it is called *hot*, and a little lime or ash must be put in to decompose the excess of chloride of copper. In both cases little amalgam is formed, as the abundantly produced sub-chloride of mercury coats the finest particles of mercury, and prevents its contact with the silver.

This simple plan is termed the *tentadura*, and, by it the *azoguero* is guided throughout the process.

When he finds at length that quicksilver is no longer absorbed, the operation is considered complete, and the torta is ready to be washed, and sometimes lime is added to stop further action. A larger quantity of mercury is then thrown in (called *el bano*, or the bath), which combines with the amal-

gam, and causes it to separate more readily from the slime in the washing. The time required to complete the process varies from 10 to 30 days, but in some places is often considerably more, according to the climate and the nature of the ore.

The amalgam has now to be separated from the mass ; this is effected at Real del Monte by washing it in a large square vat, where several men stir it constantly with their feet, and at the same time a stream of water is made to pass through. By this means the lighter particles of the mud flow out into channels furnished with basins called *apuros*, to catch all stray amalgam and mercury, whilst the great body of the amalgam remains at the bottom of the vat.

In Guanaxuato, the process of washing is more perfect ; here three circular vats called *tinas* are used ; the ore is stirred in them by means of long wooden teeth fixed in cross bars attached to a vertical shaft, the whole turned by a simple machine, worked by mules. The slime has to pass through the third vat before being carried entirely away, so that a very small portion of the amalgam escapes. The process of washing is somewhat similar in Zacatecas, but only one vat is used.

After being removed from the vats, the liquid amalgam is strained through the strong canvas bottom of a leathern bag, through which the mercury percolates, leaving behind a pasty argentiferous mixture of about 1 part of silver, and 6 of mercury. This is moulded into wedge-shaped masses of 30 lbs. each, and is now ready for distillation, which is done either in a bell apparatus (page 328), or more commonly in the following manner :—

The triangular bricks of amalgam are piled one on the other upon an iron grate standing over a reservoir of water, which is intended for the condensation of the fumes of the metal. The pile of amalgam is then covered with an iron bell, the edges of which are luted down, so as to hermetically enclose the contents. Around the iron bell a wall of loose stones is constructed, and in the circular enclosure formed by this means, a strong charcoal fire is made and continued for 8, 10, or even 24 hours, according to the amount of amalgam treated, and the size of the

apparatus employed. The apparatus is then allowed to cool, and the mercury is found separated and condensed in the interior reservoir, while the silver, in a spongy form and almost pure, is removed and fused upon a hearth of bone ash, and cast into ingots. The loss of silver by this process may amount to 30 per cent and more.

Bowring\* adds sub-chloride of copper as well as copper, iron, and zinc amalgam, in order to facilitate the amalgamation and obtain a better yield of silver.

Smith's† method of treating ores containing much gold, and less silver, by grinding them in warm cast-iron pans, with an addition of substances (sulphuric acid, caustic potash, &c.) which are able to decompose the ore, facilitates the extraction of the metals.

In South America, the so-called *hot amalgamation* (*methode des caux*) is used for the treatment of rich ores containing silver in a native state, or in the form of bromide, chloride, and iodide.

The ores are first finely ground, and then thrown, with a quantity of water, into pans with copper bottoms, under which a fire is made. From 10 to 15 per cent of common salt is added, and the contents of the pan brought to a boiling temperature. When the salt is dissolved, a quantity of mercury is added, which combines directly with the native silver, while the haloid salts are decomposed by copper, which, in presence of the solution of common salt, forms sub-chloride of copper and metallic silver. The latter then combines with the mercury. Sulphide, antimonide, and arsenide of silver, are only slightly decomposed.

The results of the manipulations in the pans are an earthy residue, and the compound of mercury and silver. The residue often contains enough silver to render it advisable for it to be added to the amalgamation in heaps.

This process occupies a shorter time than the cold amalgamation (about 5 or 6 hours), causes less loss of mercury, but it requires fuel and expensive apparatus.

\* Bergwerksfreund, 1860, 1 Lief. Berggeist, 1861, No. 49. B. u. h. Ztg., 1856, p. 49.

† Ibid., 1862, pp. 83, 133; 1860, p. 7.

## 2. Mr. Crookes's Process of Extraction by means of Sodium Amalgam.

[www.libtool.com.cn](http://www.libtool.com.cn)

Mr. William Crookes, F.R.S., has patented the use of sodium amalgam in the metallurgical treatment of gold and silver. The following are his observations on his new process of extracting the precious metals by means of sodium amalgam.

The extraction of gold and silver by amalgamation has been hitherto attended with serious difficulties, owing to the presence in the ore of sulphides, arsenic, antimony, bismuth, or tellurium compounds, which coat the gold and silver with a film of tarnish, so that the mercury cannot touch it. Again, with many minerals, the mercury is "sickened," its fluidity is destroyed, and it becomes either a tenacious mass, or assumes a powdery character. In each case its amalgamating action is almost destroyed; the result being that from 30 to 80 per cent, or even more, of the gold, and a great amount of silver escape the action of the mercury, being lost in the *tailings*, whilst large quantities of the mercury are also carried off in the washings.

The following figures, extracted from official documents, show the percentage of gold constantly being lost at some of the most important gold mines in different parts of the world.

At the St. John del Rey Mine the loss of Gold is	30 per cent.
In the Brazils generally .. .. .	30 to 35 "
In Piedmont .. .. .	35 "
At Zell .. .. .	35 to 40 "
In Hungary and the Tyrol.. .. .	50 "
In Chili .. .. .	66 "

In many cases, the waste of mercury is even more serious than that of gold.

The causes of loss in silver amalgamation are—1, the "flouring" or powdering of the mercury owing to the mechanical treatment it undergoes; 2, the "sickening" of the mercury, owing to the presence in the ore of certain deleterious minerals; and, 3, the chemical change of the mercury into corrosive sublimate and calomel, which takes place in the act of reducing the chloride of silver to the metallic state.

The employment of the patent amalgam in conjunction with the mercury will be found a remedy for each of these evils. By dissolving in the mercury some of the amalgam B, in the proportion of two parts of amalgam for one part of silver present in the ore, all these evils are prevented. The chlorine goes to the other metals present, instead of to the mercury, and the decomposition takes place so rapidly, that an operation which formerly lasted a week is sometimes finished in twelve hours.

When the mercury is brought to the state of black or grey powder, and difficulty is experienced in bringing this powder into the bright metallic state, a little of the amalgam A rubbed with it under water will quickly render it liquid and bright.

The new process possesses the following important advantages:—By the judicious admixture of a certain proportion of sodium, &c., with the mercury, its amalgamating powers, under all circumstances, are preserved and intensified. It will extract gold and silver from sulphides and minerals which have hitherto resisted the ordinary process; it will seize upon gold so tarnished that it would otherwise pass untouched through common mercury and be lost in the tailings; it will absolutely prevent the *sickening* and *flouring* of the mercury, conditions which hinder the extraction of the gold and silver; and, finally, the yield of precious metal is greatly augmented, and an immense saving of mercury is effected.

When some or all of the above-mentioned minerals are present with the gold and silver (and especially if the gold occurs with pyrites), the mercury in which the ore is triturated becomes *floured*, *granulated*, or *powdered*, *i.e.*, it becomes subdivided into excessively minute globules, which, owing to the film of tarnish they have contracted, refuse to reunite, and are consequently washed away, it being almost impossible to effect their separation from the heavier portions of ore.

The presence of some of these minerals affects the mercury in another way, *viz.*, by *sickening* it. *Sick* mercury is that which has lost its fluidity, and will not flow with a bright surface, nor touch gold or silver except with great

difficulty. The ill effects of *sickening* are not so great as those of *flouring*, as *sick* mercury can generally be restored by distillation, when not much is lost; the chief objection being that it will not take up gold and silver; but *floured* mercury is not only entirely lost, but it carries away with it all the precious metal already taken up.

Another very serious loss is the following:—Even when the mercury preserves its bright metallic condition, and is in the most active state ever met with in commerce, it will seldom take up more than half or two-thirds of the gold or silver present, owing to the precious metal being naturally tarnished on its surface, and resisting the action of the mercury except when they are ground together for a longer time than is usually practicable.

All these sources of loss are avoided by dissolving a little of the sodium amalgam A, B, or C, in the mercury before it is introduced into the amalgamating vessels.

**Amalgam A** is a simple mixture of sodium and mercury; a convenient strength is 3 parts of sodium and 97 parts of mercury. The preparation of this amalgam is as follows:—Place a strong iron flask with a narrow neck nearly up to the mouth in sand on a sand-bath, kept at a temperature of about 300° F. Weigh out the mercury and sodium; put the former into the flask, and then add the sodium in pieces as large as a pea at a time, waiting for the action to cease before adding a fresh lump. The sodium had better be dropped in with a pair of tongs, and the hand should have a cloth over it. At each addition of the sodium a slight explosion will be heard, and a bright flame will issue from the mouth of the flask. The action gets less violent as the mercury becomes richer in sodium. When the whole of the sodium has been added, pour the amalgam into a flat dish whilst still liquid, and when cold break it up and preserve in a stoppered jar. It will not require to be kept under naphtha. The amalgam forms a mass of long, needle-shaped, brilliantly-metallic crystals, which interlace in every direction, but have very little cohesion.

**Amalgam B.**—Weigh out 77 parts of mercury, 3 parts of sodium, and 20 parts of zinc; unite half the mercury with



the sodium, taking the customary precautions. Then melt the zinc, remove the crucible from the fire, and just before the metal is going to solidify, pour in the remainder of the mercury with constant stirring; then add the mixture of the sodium with the first half of the mercury, and heat the whole together till both amalgams are melted; stir with an iron rod, and cast the mixture into any desirable form in an ingot mould.

**Amalgam C.**—Weigh out 77 parts of mercury, 3 parts of sodium, 10 parts of zinc, and 10 parts of tin; proceed exactly as in making amalgam B, only adding the tin to the zinc in the first instance.

Metallic sodium and all amalgams containing it must be carefully preserved from damp in well-closed vessels.

The best proportion of amalgam to the mercury must be found out by experiment, as nearly every kind of ore will require a different treatment, but considerable latitude is permitted, and the addition of a little too much does not appear to do harm. It is recommended that one part by weight of amalgam B or amalgam C be dissolved in 30 parts of the mercury which is to be used in the amalgamating vessels or triturating or grinding machines, and the effect which it produces on the mercury noted from time to time during the operation. If the mercury retain its fluidity and brightness to the end of the operation, it is a sign that either sufficient or too much has been added, and a second experiment should be tried with the addition of a diminished quantity of amalgam. But if it be *floured*, or *sick*, or any be lost, more amalgam may be added, until the best proportion is arrived at.

Amalgam B will generally be found effective, but if the ore contain an excess of any mineral which has a deleterious action on the mercury, more especially if this mineral contain bismuth, it will be advantageous to employ amalgam C instead of amalgam B.

When the best proportion of amalgam B or amalgam C is ascertained, small quantities of amalgam A should be introduced into the mercury already containing amalgam B or C, in the proportion of 1 part of amalgam A to 1,000 of mercury.

This quantity of amalgam A can be added every 3, 6, 12, 18, or 24 hours, according to circumstances; but one charge of amalgam B or amalgam C will usually be sufficient for the mercury for several days, or a week. Under some circumstances, it will be found advisable to add amalgam B or amalgam C every few days. A little experience and comparison with the results obtained by the old plan will soon show how these several agents are best utilised.\*

Amalgams B and C are chiefly of use in preventing the mercury *sickening* or *flouring*, whilst amalgam A is most powerful in increasing the affinity of mercury for the precious metals, and in bringing back *floured* mercury to the bright liquid state.

In many mining establishments, it is found advantageous to employ amalgamated surfaces of copper, over which the crushed ore, tailings, and slimes, or such materials are allowed to flow; or to introduce amalgamated copper plates into the triturating and grinding machines. By this means some of the precious metal and floured mercury, which otherwise would have been lost in the tailings, is collected on the copper, and may be scraped off from time to time. The adoption of this practice will be found of great use in all gold and silver amalgamating works, in which the extensive adoption of amalgamated metallic surfaces is recommended for the riffle boxes, launders, shaking and percussion tables, floors, or other parts, along or over which the crushed ores, tailings, slimes, or such material flow.

By employing amalgam A in coarse powder and sprinkling it over the wetted metallic surface to be amalgamated, and then rubbing it over with a little clean mercury, a firmly adherent and brilliant coating of mercury will be given to the metal. Not only can copper be amalgamated in this way, but the same result is produced on galvanized iron (iron coated with a thin layer of zinc), on tin plate (iron coated with a thin layer of tin), on lead, and less

\* The retail price of sodium being about 6s. per lb. at the present time in London, and the addition of less than 0.1 per cent being sufficient to put the mercury into a highly active state, it will be seen that the expense of the process is very trifling.

perfectly on iron and steel. In all cases it is advisable to preserve the effective surface and the amalgamating energy of the mercury on the metal plates by an occasional sprinkling of powdered amalgam A, applied from time to time as required.

#### Illustrations of the Sodium Amalgamation Process.

The following experiments show the special action of amalgams A, B, and C upon *floured* and *sick* mercury, and upon gold and silver ores :—

1. Take a piece of dry chloride of silver and put it in a watch glass or small dish. Cover it with water, and put a globule of mercury of about its own bulk in contact with it. The two may be rubbed together for hours without any apparent change taking place; but if a piece of either of the amalgams A, B, or C, be dropped into the mercury, the latter will seize hold at once upon the chloride of silver and in a few minutes will appear to have eaten its way through, reducing it to the metallic state, and at the same time amalgamating with the silver.

2. Take about five grains of pure mercury and put it into a small dish or a watch glass. Pour over it a few drops of solution of perchloride or persulphate of iron. This will *sicken* the mercury at once, especially if it be moved about with the finger. When thoroughly *sick*, drop into it a piece of amalgam A, B, or C, about one-hundredth part of the size of the mercury. Instantly, as if by magic, the *sick* mercury recovers, and assumes its globular form.

3. Sicken another globule of mercury in the same manner. Pour on to it the recovered mercury from the former experiment (No. 2), and it will be seen to cure the second portion also.

4. Thoroughly flour or powder a dozen grains of mercury by violently shaking them in a bottle with weak gum-water and a few drops of perchloride of iron. Pour off the liquid and wash once or twice. Now transfer the powdered mercury to a dish, put into it a few grains of amalgam A, and gently rub them together under water. In a few minutes the whole of the mercury will be reduced to the bright

metallic state. Mercury floured and sickened with grease may be brought back to the active state with the same readiness.

5. Take two portions of pure mercury (about 100 grains each). Pour water over them, and put ten grains of amalgam A into one of them. Now take a piece of silver or gold ore, containing visible silver or gold in it, and dip it into the common mercury; scarcely any action will take place, or perhaps none. Then dip the same piece into the amalgamated mercury, and it will instantly unite with the gold or silver. A gold or silver coin dipped into common mercury will seldom be acted upon except in a few spots, but when dipped into the amalgamated mercury it is instantly wetted by the metal over its whole surface. The same experiment may be performed with a piece of gilt paper.

6. Take some iron pyrites and mix with it any of the ores which are most antagonistic to amalgamation by the ordinary process, such as arsenic or tellurium ore. Grind up 100 grains of this mixture with five grains of pure mercury and a very little water for about two minutes, then wash away the pyrites and examine the state of the mercury which is left behind. Nearly all will be washed away, and what is left will be in the form of a dull-looking powder or flour.

7. Repeat the same experiment, after having added to the mercury a small piece of amalgam C. The mercury will be kept in the bright globular condition during the whole of the experiment, and, upon washing away the pyrites, the metal will be left behind in one globule without loss.

If the pyrites or other mineral contain gold or silver the amalgamated mercury will be found upon examination to have absorbed it all, whilst the common mercury will have taken up scarcely any.

The following extracts from reports on Mr. Crookes's process prove its advantage over the older amalgamation processes; and we may also state here that this process has already come into extensive use\* :—

\* Messrs. Johnson, Matthey, and Co., Hatton Garden, London, have arranged with the patentee to supply the amalgams A, B, C, in barrels of 2 to 5 cwt. each, or smaller quantities in tins or jars. They also prepare a concentrated amalgam A five times the strength of the above, in solid bars for shipment when the expense of freight or land carriage is great. This is

Dr. A. W. Hofmann, F.R.S., in Berlin, late Professor in the Royal College of Chemistry, London, says that Mr. Crookes's process is an improved one for extracting gold and other metals from their ores by means of sodium amalgam, instead of pure mercury.

He states that the "phenomena witnessed in comparative experiments made with ordinary mercury, and with mercury to which a very small amount of sodium amalgam had been added, were truly startling. Under circumstances in which ordinary mercury rapidly lost its fluidity and globular form, the metal containing sodium retained them unimpaired; and mercury which had become entirely altered, regained its fluidity and globular character almost instantaneously on the addition of a small amount of sodium amalgam. A gold coin which could be dipped for a few moments into ordinary mercury without being attacked in the slightest degree, was instantaneously covered with mercury, when a small bit of sodium amalgam had been added to the metal. Auriferous quartz, with visible spangles of gold, exhibited exactly the same deportment.

"The advantages that must accrue in a commercial point of view are to my mind undoubted. It will now be possible to obtain a greater percentage of gold than heretofore from any given ore; and as regards the poorer auriferous ores, it will now be possible to work them also remuneratively."

Dr. Wm. Allen Miller, V.P.R.S., Professor of Chemistry in King's College, London, has given his opinion as follows:

"The principle is sound; the process extremely simple; the operation works into the ordinary method of amalgamation completely and does not require any special machinery, and, so far as I have at present been able to judge, the method promises to be a most important aid in preventing loss of gold and silver, and in economising the quantity of mercury

supplied in tins, made up in cases of about 56 and 112 lbs. each. Amalgams B and C cannot be prepared in the concentrated form. In consequence of the great difficulty in shipping the metal sodium (all the mail packets and first-class vessels refusing to carry it), and also of the danger of explosion and waste of sodium experienced by most operators in preparing the amalgam, the export of this metal has almost ceased, and only amalgam or prepared mercury is now exported.

required in conducting the extraction of the precious metals by amalgamation."

Dr. Frankland, F.R.S., Professor of Chemistry in the College of Chemistry (Royal School of Mines), London, gave the following report:—

"I have to report that, so far as I am able to judge from experiments on a small scale, the process appears to be of great value and importance. In the processes for extracting gold and silver by amalgamation, the mercury becomes *floured* or *sickened*, which causes it to be more or less carried away and lost. The mercury so washed away carries with it all the gold or silver which it has taken up.

"This loss Mr. Crookes prevents by the addition of an amalgam of sodium. In the native state, gold and silver are always coated with a film, which prevents the contact of these metals with mercury except after long grinding, in consequence of which large quantities of gold and silver are always being washed away in the *tailings*. Mr. Crookes attains the necessary contact by the addition of a trifling percentage of sodium amalgam. Although these experiments were performed upon small quantities of materials, there is nothing in their nature indicating difficulty in the application of the several processes upon a manufacturing scale. Indeed, all the operations are essentially the same in character as those long employed in metallurgical operations involving amalgamation."

Dr. Odling, F.R.S., Professor of Chemistry, St. Bartholomew's Hospital, London, reports that, from the experiments he has made on the new process, he is satisfied that it will do what it professes, that is to say, effect a great saving of mercury, a more exhaustive extraction of the precious metals from their matrices, together with a more complete collection of them after extraction, and also a considerable saving of time and labour. He says that this process seems to do away with the *sickening* or *flouring* absolutely, whereby it will altogether prevent the loss of mercury from this cause, and indeed almost any appreciable loss whatever. Gold, as it exists in quartz, is very imperfectly wetted by ordinary mercury, and is scarcely

affected at all by that which is *floured* or *sickened*. Hence a greater or less amount of gold habitually escapes solution by the mercury, and is lost in the tailings. But gold of all sorts is wetted by mercury containing a little sodium amalgam with as much facility apparently as a piece of soap is wetted by water. He proceeds to state his conviction that the employment of this process will result in the more complete extraction of the precious metals by the mercury. Moreover, by preventing the *flouring* of the mercury, and so enabling it to be entirely recovered, all the gold and silver extracted by it will also be recovered, instead of being partially lost as heretofore in the unrecovered *floured* mercury. Dr. Odling concludes by saying—

“It is obvious that a more rapid and efficient extraction of the precious metals by the mercury, and a more rapid and complete collection of the mercury after their extraction, must result in a great saving of time and labour.”

Robert Hunt, F.R.S., has made the following statements in the *Quarterly Journal of Science*, October, 1865, in an article “On British Gold,” with especial reference to the Gold Mines of Merionethshire:—

“The extraction of gold by amalgamation is attended with serious difficulties. Whenever sulphides, arsenic, bismuth, or tellurium are present with the gold, they frequently tarnish the metal, and the mercury cannot act upon it. Technical language informs us, that the mercury *sickens*, that is, it grows thick, or that it *flours*, meaning that it becomes pulverulent. These conditions are dependent upon the presence of other metals. Under either of those circumstances much of the gold escapes the influence of the mercury, and is lost in the *tailings*, whilst much of the mercury itself is carried off in the washings. Mr. William Crookes, F.R.S., the discoverer of the new metal thallium, has introduced an improvement which promises to be of the utmost advantage in all our operations for obtaining gold in quartz-mining, or when it is combined with other minerals.

“Mr. Crookes’s process possesses the following important advantages:—By the judicious admixture of a certain proportion of sodium with the mercury its amalgamating powers

are, under all circumstances, preserved and intensified. It will extract gold from sulphides, and from such other minerals as have hitherto resisted the ordinary process; it will seize upon gold tarnished by any of the metals named above, and which would pass untouched through common mercury and be lost; it will absolutely prevent *sickening* and *flouring*; consequently the yield of gold is augmented, and a large saving in mercury is the result.

“A series of experiments were made to determine the action of the sodium under such circumstances as presented unusual difficulties, and the results of these trials were as follows:—

“It should be stated that the mercury contained one per cent of sodium.

“1. When a little of the sodium amalgam was added to ordinary mercury, the affinity of the latter for gold was greatly increased, so that when pieces of gold were dipped into it they were instantly covered with mercury, although when dipped into mercury to which no sodium had been added, amalgamation was very slow, and difficult to obtain.

“2. *Floured* mercury immediately ran together into a single globule, on the addition of a little sodium amalgam.

“3. When iron pyrites (bi-sulphide of iron), magnetic iron pyrites (sulphide of iron), or copper pyrites (sulphide of copper and iron), were triturated with sodium amalgam, the pyrites were decomposed, and on the addition of water a black precipitate of sulphide of iron was obtained.

“4. Triturated with sodium amalgam—*a*, arsenical pyrites was decomposed and arsenic amalgam formed; *b*, galena (sulphide of lead) was decomposed and lead amalgam formed; *c*, blende (sulphide of zinc) was decomposed and zinc amalgam formed; *d*, litharge (oxide of lead) and white lead (carbonate of lead) were decomposed and lead amalgam formed. An extensive series of experiments has been made at the mines near Dolgelly, and in every case a considerable increase in the quantity of gold has been effected by the use of the sodium amalgam. The only thing which appears to be necessary to ensure the usefulness of the sodium amalgam in all cases, is a preliminary experiment to determine the



quantity of sodium which should be used with the mercury. This discovery promises many advantages to the adventurers in the auriferous mines of Wales, and it will probably lead to the successful working of some of the poor quartz lodes through which the sulphides and arsenides of the baser metals are disseminated, and thus prove a solution of the problem, Can British gold be worked with commercial advantage?"

J. Mosheimer, Esq., communicates to the *San Francisco Mining and Scientific Press* :—

“ I am continually receiving letters from the interior asking questions as to whether sodium is a benefit to amalgamation or not. My answers are always that it is. Mr. T. A. Readwin wrote to me about eight months ago, that he was making experiments in North Wales with sodium amalgam. He informs me that he uses small iron pans and my amalgamators ; an equal number of pans being worked with and without sodium. The result has been that at least 30 per cent more gold was produced with sodium than without. About five months ago I received several lots of ore to work, and I determined to give sodium a fair trial. I worked the same ore side by side with the same machinery, and the results were as follows :—First lot of 500 lbs. each pan,—with sodium, yielded 85 per cent of the assay; without sodium the yield was only 55 per cent. Second lot, different ore, with sodium, 80 per cent ; without sodium, 60 per cent. Third lot, different ore, with sodium, 78 per cent ; without sodium, 65 per cent. I made many more trials, and found that I got from 5 to 25 per cent more by using sodium than I could obtain without its aid.”

According to experiments made at Manchester on a considerable quantity of auriferous quartz from the Montezuma mine, California, the yield with ordinary mercury was 7·04 dwts. per ton ; but when the amalgamation was conducted in the presence of a small proportion of sodium amalgam the yield was 1 oz. 4 dwts. per ton. The experiments were conducted with every precaution necessary to ensure a fair result, the quartz having previously been finely powdered and sampled, and the operations carried out under the immediate

superintendence of F. Berger Spence, Esq., F.C.S., and J. Carter Bell, Esq., F.C.S.

The following are reports of some experiments which were made at the gold bearing districts in Wales, in the spring of 1865 :—

At the Castell Carn Dochan Mine, pyrites which by common amalgamation would yield scarcely anything, gave, when treated by the sodium process, at the rate of 5 ozs.  $12\frac{1}{2}$  dwts. per ton.

At the Gwynfynydd Mine, Mr. Readwin and Mr. Spence obtained, with sodium, 1 oz. 1 dwt. of gold per ton, against 17 dwts. produced by the ordinary process, thus saving 4 dwts. per ton. In a second experiment conducted at the same time, Mr. Readwin and Mr. Spence obtained 3 ozs. 1 dwt. 8 grains per ton by the sodium process, against 2 ozs. 14 dwts. by the common process, saving 7 dwts. 8 grains per ton. In a third experiment by the same gentlemen, the ore containing large quantities of arsenic, pyrites, &c., *no gold* whatever was obtained by the ordinary process, whilst the same ore by the sodium process yielded 6 ozs.  $13\frac{1}{4}$  dwts. of gold per ton.

At the Gwynfynydd Mine, Messrs. Readwin and Spence report (*Mining Journal*, May 20) :—“ All the sulphides and other minerals of the Dolgelly district, hitherto antagonistic to the process of amalgamation with quicksilver in its usual state, were subjected to a severe test with sodium amalgam in Britten's amalgamating machines, and at the end of every experiment the quicksilver was perfectly bright. The results were highly satisfactory.”

At the Cwmheisian Mine, Mr. Readwin reports (*Mining Journal*, June 17) :—“ Experiments on the ores from this mine with sodium, have resulted in a satisfactory yield of gold, which could not hitherto be obtained by Berdan's, Mitchell's, Britten's, Mosheimer's, or any other amalgamating machinery used *without sodium*.” In a further experiment, 17 dwts. of gold per ton were obtained by sodium from ordinary lode-stuff.

Mr. Thomas Belt, late manager of the Prince of Wales Gold and Lead Mine, Dolgelly, who has had very considerable experience in gold mining in Nova Scotia, has used the

sodium process with great success in extracting gold from galena by amalgamation. The assay of the galena showed that it contained 13 dwts. 16 grains of gold per ton; amalgamation in the ordinary way with common mercury only extracted 6 dwts. 12 grains of gold per ton, whilst when the amalgamation was conducted with the addition of a very small quantity of sodium amalgam the whole of the gold present was recovered, the yield being 13 dwts. 10 grains per ton.

An interesting series of experiments with sodium amalgam in the treatment of auriferous ores has been conducted under the superintendence of Professor Silliman, and the results obtained are highly satisfactory. Having at his disposal a considerable quantity of Californian gold quartz from a mine in Calaveras county, he subjected these ores to this method of amalgamation, under conditions subject to control, both as expressing the actual value of the material experimented on, as well as giving the value of the results, and the loss in the process. The crushing and grinding was effected in the apparatus of Mr. M. B. Dodge, of New York, which, doing its work dry, gives unusual facilities for exactness. The details obtained in these experiments as to the degree of comminution reached by this apparatus have been very carefully worked out. After detailing the several experiments which were actually concluded, Professor Silliman states that the results show that with unaided mercury the gold saved is less than 60 per cent of the whole quantity of gold known to be present. In one experiment less than 40 per cent was saved, whilst by the aid of the amalgam of sodium the saving is increased to 80 per cent, or 80·3 per cent, or an increase of more than 40 per cent, leading to the reasonable expectation that in the large way at least 80 per cent of the gold present in a given case may be saved, and, in many cases, where the gold is coarse and free, that even better results than this may be attained. The first experiment detailed in which a different amalgamating apparatus was used gave results surprisingly close. Experiments in California, under his direction, have been set on foot upon a scale of magnitude adequate to test the

value of this discovery in the metallurgy of gold in a satisfactory manner. With regard to the mode in which the sodium acts, Professor Silliman remarks that the action of the sodium in this case appears to be in a manner electrical, by placing the mercury in a highly electro-positive condition towards the electro-negative gold. The quantity of sodium is altogether too small to allow of the supposition that it acts by its chemical affinities. The use of the sodium amalgam for silver amalgamation must depend upon a like power of electrical action to that seen in its action on gold, and also to the well-known power of preventing the granulation (flouring) of mercury, or of saving the mercury when thus changed. Indeed, there is good reason for believing that a most important part is played by the sodium amalgam in this last particular. The amalgam of gold or silver is very liable, as every millman knows to his loss, to granulate and disappear from the plates of the battery, or from the ruffles, after it has been formed. If this granulation takes place it is almost impossible, by the existing modes of amalgamation, to recover the minute particles, as they float off with the currents of water and are lost. The action of the sodium in recovering the mercury which has passed into this condition is, perhaps, its most remarkable property.

At the session of the National Academy of Sciences, held at Washington, in January, 1866, Professor Silliman read a paper upon the sodium amalgamation, detailing the results of a series of experiments conducted by him upon a scale of sufficient magnitude to test the value of this discovery upon gold quartz. In one experiment made on over 500 lbs. of low grade ores, worth about 15 dollars per ton, the sodium amalgam extracted practically all the gold not existing in the sulphides. This experiment was conducted in a large-sized Freiberg amalgamator, and was continued for one hour, the sodium amalgam being added in four successive portions of 1 oz. each, dissolved in a portion of the 20 lbs. of mercury employed. The loss in mercury was about 1 oz. in this experiment, the quantity of the sodium amalgam being 1·2 per cent of the total quantity of mercury in use.

In a second series of experiments, conducted on carefully

prepared samples of richer ore, worth 320 dollars per ton, treated in a revolving barrel, the saving by ordinary mercury was from 40 to 60 per cent of the total quantity of gold present. With the aid of sodium amalgam 83·3 per cent was recovered.

The new process has been in use for some time at the gold mines at Clear Creek, Tulare County, California, where the owners report\* that the quicksilver is rendered remarkably quicker and livelier for absorbing the particles of gold, by the immersion of small lumps of sodium amalgam. The employment of this process is considered by the owners as a decided improvement.

A correspondent of the *Mining Journal*,† writing from America, says :—“ A third great discovery is the union of metallic sodium with mercury, the affinity of which latter for other metallic substances is thereby indefinitely, not to say infinitely, increased. The value of this discovery is no longer open to doubt ; it is established beyond question, and enjoys the fullest confidence of all who have witnessed its operation. It is being largely introduced into the mining operations of America. This discovery cannot fail to take rank among the most useful of our time.”

The new process has been in use for some time in Mexico, at the Works of the Real del Monte y Pachuca Silver Mining Company (one of the largest silver mines in the world), and the Directors report‡ that they have obtained, by its means, better results in the produce, as regards economy both of time and of mercury.

The St. John del Rey Gold Mining Company (Brazils) have also commenced experiments, upon which they report favourably.

An extract from the *Colorado Journal*, quoted in the *American Journal of Mining*, for July 14, informs us that by the use of sodium amalgam the yield of the Narragansett mill has been increased more than 30 per cent. The same journal for July 21, quotes as follows :—“ Mr. John P. Bruce

\* *The Miner*, a San Francisco paper, March, 1866.

† *Mining Journal*, April 28th, 1866.

‡ *El Diario del Imperio*, Mexico. Viernes, 22 de Diciembre de 1865.

is running his old twelve-stamp mill, two batteries, six stamps in each. For four days last week he used the mercury treated by sodium amalgam in one battery, and common mercury in the other. He got one ounce and nineteen dwts. more gold in the former than in the latter. Mr. Emery also tried some of it in the Narragansett mill just before it shut down. In one section of twenty heavy stamps he used the sodium amalgam for two batteries, and the common mercury for the other two during a run of three days, obtaining from the former five ounces of amalgam more than from the latter, which retorted 6.50 dollars an ounce, or 32.30 dollars in all. At the same rate the use of it in the forty stamps of the Narragansett mill for a week would increase the yield by 260 dollars. Probably this result would be even better with more experience."

The following extract from a letter from a correspondent of the patentee in Nova Scotia will be found interesting:—  
"The experiments which I carried out with Dr. K. at the Lake Major Gold Mines proved so satisfactory that Dr. K. was induced to operate upon a quantity of pyrites, which, as you are aware, has hitherto been accumulating as waste matter in enormous quantities about the works. This morning he informed me that he has, by the sodium process, and in a very simple and inexpensive way, obtained gold from the pyrites in the proportion of *five ounces per ton*. This result far exceeded his most sanguine expectations."

The following report from Messrs. Johnson and Matthey will show what the sodium process is capable of effecting in experienced hands—

"Platinum and Metallurgical Works,

"Hatton Garden,

"London, January 9th, 1867.

"We beg to make the following report on the result of experiments with the sodium amalgamation process:—

"The ore selected was a compound mineral from California, with which great difficulty had been experienced in working in the ordinary way.

"The results obtained in our laboratory were as follows:—

	ozs.	dwts.	grs.
Produce by assay, per ton . . . . .	7	9	6
Produce by usual process of amalgamation, per ton . . . . .	2	16	0
Produce by sodium process of amalgama- tion, per ton . . . . .	7	0	6

“The trials were twice repeated, and the results were marvellously uniform.

(Signed) “Johnson, Matthey, & Co.”

### 3. Treatment of Silver Ores and Argentiferous Products in the Wet Way (by Solution and Precipitation).

The different processes by which silver is extracted from argentiferous ores and products by the wet way are all of modern origin, and they have in many instances supplanted the old processes of amalgamation and liquation, being cheaper, and allowing the quicker and more complete extraction of the metal.

But these processes in the wet way require ores of a certain purity, as otherwise a great loss of silver takes place. Ores containing lead, antimony, arsenic, zinc, &c., are not suitable, and the fact that silver ores frequently contain those substances has prevented a more extended application of the processes.

#### Augustin's Process of Extracting Silver with Salt Water.

This process is based upon the following chemical facts:—

When roasted with common salt argentiferous ores or products form chloride of silver, which is soluble in a concentrated solution of common salt, forming a double salt ( $\text{NaCl} + \text{AgCl}$ ). From this solution the silver may be precipitated by copper, which again may be precipitated by iron. The remaining solution, after being purified from iron, sulphate of soda, &c., may be employed for dissolving a fresh quantity of chloride of silver.

The solubility of chloride of silver in salt water has been known for a long time; but Augustin\* was the first who made

\* GRUTZNER, die Augustinsche Silberextraction, Braunschweig, 1851. DINGLER'S Polyt. Journ., tom. 106, p. 75.

a practical use of this fact, and introduced it at the Gottesbelohnungs furnace, near Eisleben, in Prussia, supplanting the amalgamation process formerly used for the treatment of copper matt. This process is much cheaper than amalgamation, necessitating no loss of quicksilver.

On comparing these processes a difference will first appear in the roasting. While the ores, &c., for the amalgamation process are roasted at once with common salt, the substances to be treated by Augustin's process are first roasted by themselves (*i.e.*, oxidised), and afterwards with an addition of common salt, for the formation of chlorides. This double roasting is done in order to produce little or no chlorides except chloride of silver. The oxidising roasting volatilises a great part of those substances which would otherwise readily combine with chlorine, causing a great consumption of salt, and it serves to convert those metals, whose combination with chlorine would not be advantageous to Augustin's process, into oxides or arseniates having no tendency to form chlorides in the subsequent roasting with common salt. For instance, if the metals silver, copper, cobalt, and nickel, are present either in a sulphuretted state or as arsenides, and it is intended to extract all the metals, the compound has to be first oxidised by roasting, thus producing sulphate of silver, free oxide of copper, and arseniate of cobalt and nickel. If these products are now roasted with an addition of common salt, chloride of silver will result, while the other substances are little affected by chlorine. The presence of foreign chlorides facilitates the volatilisation of silver during the second roasting, renders the subsequent lixiviation difficult, and contaminates the precipitated silver.\*

Another difference between the two processes is the following:—

In the amalgamation process a further formation of chloride of silver may take place in the casks if foreign chlorides are present; that formation cannot take place in Augustin's pro-

\* Oesterr. Ztschr., 1857, p. 108. PLATTNER'S Röstprocesse, 1856, p. 284. B. u. h. Ztg., 1854, p. 126.



cess, as the reagent for extraction (solution of salt) only dissolves chloride of silver, but does not form it. Its formation must be finished therefore, in the latter case, by a longer roasting.  
[www.libtool.com.cn](http://www.libtool.com.cn)

Sulphuretted argentiferous compounds are best adapted for Augustin's process. When treating such substances (*i.e.*, pure, raw, or copper matt) the loss of silver frequently is no more than 6 per cent, and even less. That loss is caused partly by volatilisation and partly by the residues which always contain more or less silver; and it is considerably increased if metals are present either in combination with sulphur, arsenic, or antimony, which form easily caking combinations by the oxidising roasting, or which form sulphates or antimonates, such as lead, zinc, antimony, &c.

In the last case many volatile chlorides will be formed by the chlorination roasting, which by their volatilisation carry away chloride of silver. They also occasion the formation of chloride of copper, which then becomes partly volatilised, whilst the remaining part is reduced to sub-chloride of copper, and dissolves in the salt water together with the chloride of silver. When the chloride of silver is precipitated, the sub-chloride of copper becomes again oxidised, forming oxychloride of copper, which being insoluble contaminates the precipitated silver. This is also the case with chloride of lead, which is soluble in hot salt water, and separates from the solution as it cools.

A previous roasting of antimonial and arsenical products either with or without the application of steam, an extraction of the chloride of lead by means of hot water previous to the complete chlorination and lixiviation of the silver, a double roasting and a double lixiviation of speiss, &c., &c., are suitable modifications of the process which have been partly employed in Hungary,\* and for the desilverising of black copper and speiss containing lead and antimony; though it is to be understood that the antimoniate of silver which has been formed by the oxidising roasting, will only be imperfectly decomposed by common salt.

If the oxidising roasting of copper matt has been imper-

\* B. u. h. Ztg., 1855, p. 64.

fect, much sulphate of copper will remain instead of oxide of copper, causing the formation of a large quantity of chloride of copper, which then occasions the above-mentioned disadvantages, besides a volatilisation of chloride of silver. The roasting furnaces must, therefore, be furnished with condensation flues. When applying steam\* at the roasting process the volatilisation of silver is lessened, but the consumption of fuel is increased.

Gold can only be partially extracted, according to Grützner to  $\frac{1}{3}$ rd, as is also the case in the amalgamation process, and the residues have to be treated, according to Plattner's method, by chlorine gas, in order to extract the remaining gold.

Roeszner† and Patera‡ have lately found a mixture of cold salt water and chlorine water to be an excellent reagent for extracting gold and silver at the same time.

Kiss's|| method of extracting gold and silver at the same time by means of hyposulphite of lime, has given less satisfactory results.

Different experiments, chiefly in the wet way, have been made to lessen or to avoid the loss of silver caused by the chlorination roasting, but the results obtained have not been so satisfactory as to supersede the usual roasting with common salt.

Gurli§ treats argentiferous substances in rotating casks with chloride of copper and salt water. Becquerel¶ has employed common salt and roasted pyrites as in the American amalgamation process.

Markus\*\* roasts in a muffle, with an addition of iron pyrites, and the use of a steam jet; he afterwards sifts the

\* Oesterr. Ztschr., 1860, No. 11. B. u. h. Ztg., 1861, p. 60.

† Oesterr. Ztschr., 1863, Nos. 25 and 40. B. u. h. Ztg., 1863, p. 336.

‡ Oesterr. Ztschr., 1863, No. 24.

|| NEUMANN'S EXTRACTION, 1863. B. u. h. Ztg., 1862, p. 319; 1864, p. 102.

§ DINGLER'S polyt. Journ., Bd. 120, p. 433. Bgwksfd., xv., 13. B. u. h. Ztg., 1851, p. 692; 1859, p. 54; 1861, p. 79. Berggeist, 1860, No. 34. KERL, Rammelsberger Hüttenprocesse, 1861, p. 103.

¶ Bgwksfd., i., 266, 541; iii., 282. DINGLER'S Polyt. Journ., Bd. 60, p. 76; Bd., 69, p. 165; Bd. 133, p. 213. B. u. h. Ztg., 846, p. 63. Ergänzungsheft.

\*\* Oesterr. Ztschr., 1856, p. 171; 1858, 79. B. u. h. Ztg., 1856, p. 266.

roasting mass and treats the sifted substance with a solution of common salt, and chloride of copper or iron. Meyer\* moistens the argentiferous copper ores with muriatic acid, allowing them to remain about a fortnight for the formation of chloride of copper; they are then submitted to a chlorinating roasting without the addition of common salt.

Augustin's process is less applicable to ores than to such products as speiss, matt, and black copper, as the ores more frequently contain substances liable to prevent a perfect chlorination.

This process is nowhere employed for the treatment of ores, and the experiments which have been made with this object in several establishments were executed on too small a scale to allow a fair opinion to be formed as to the applicability of the process to ores.

#### **Augustin's Process for the Treatment of Copper Matt.**

Copper matt, rich in copper (60 or 70 per cent), but free from intermixed metallic copper, lead, zinc, antimony, and arsenic, may be desilverised by Augustin's process with the least loss of silver. The copper present is favourable to the production of residues poor in silver, but intermixed metallic copper, which always contains silver, can only be imperfectly chlorinated if lead be present, as, by forming oxide and sulphate of lead, it encrusts the copper and prevents its chlorination. It is advisable first to submit the copper matt to a concentration smelting in reverberatory furnaces.

Any lead contained in the matt should first be transformed into chloride of lead, and then extracted by means of hot water; this must be done previous to the treatment of the roasting mass by salt water.

The desilverisation of the copper matt requires the following manipulations:—

*a.* **Roasting the Copper Matt.**—The matt is finely ground and sifted, and then roasted at a low red heat on the upper

\* B. u. h. Ztg., 1862, p. 179.

hearth of a double reverberatory furnace for about 5 hours, in quantities of about 4 cwts.; afterwards it is roasted at the same temperature for about two hours on the lower hearth, and then the roasting is continued for three hours longer at an increased temperature. The silver contained in the matt will then be mostly transformed into sulphate of silver, and only a small part of it into metallic silver, while the metals iron and copper are converted into oxides, and some little basic sulphates. A sample of this roasting mass when lixiviated, will scarcely appear blue, and a grain of common salt will produce in it a precipitate of chloride of silver.

The roasting mass is now taken out of the furnace, mixed with from 1 to 6 per cent of common salt, according to the purity of the copper matt, and is then roasted again for about  $\frac{3}{4}$  of an hour, below a red heat, in order to prevent the volatilisation of silver as much as possible, and also to avoid a fusion of the chloride of silver (which takes place at the low temperature of  $260^{\circ}$  C.), as this chloride is difficult to dissolve when in a fused state. This second chlorinating roasting produces chloride of silver, and some chlorides of iron and copper. The formation of many foreign chlorides will take place if the first roasting has not been carried on sufficiently, or if the matt be contaminated with zinc, lead, antimony, arsenic, &c.

*b. Lixiviation.*—The roasting mass is lixiviated whilst hot, by a concentrated hot solution of common salt. According to Patera's method,\* this lixiviation is effected by applying pressure, in order to make the extraction quicker and more complete.

*c. Precipitation.*—The solution of the former lixiviation contains the double salt  $\text{AgCl} + \text{NaCl}$ , the silver of which is then precipitated by copper. The copper from the resulting solution is again precipitated by iron. The resulting *cement silver* is first washed with water or acids to free it from chlorides of lead and copper, &c., and then dried and

\* Jahrbuch. der k. k. Geolog. Reichsanstatt, 1850, p. 573; 1851, p. 52. B. u. h. Ztg., 1851, p. 689.

refined. The residues are worked up for the production of spongy copper, if they do not contain enough gold to make its extraction profitable.

Augustin's process was adopted in Freiberg\* during the years 1848 to 1862, and was abandoned again in favour of the treatment of copper matt with sulphuric acid, which is a great deal more profitable for this purpose. An account of six months' working of copper matt by Augustin's process, shows that the profit amounted to 5·746 per cent, while the treatment of copper matt by sulphuric acid during the same period yielded a profit of 15·9 per cent.

Augustin's process was carried on in Freiberg as follows:

The copper matt having been previously roasted, and afterwards stamped and sifted, contained about 70 per cent of copper, 5 per cent of lead, a little iron, and from 0·25 to 0·4 per cent of silver; it was roasted in quantities of about 4 cwts., as before described.

The lixiviation of the well roasted matt is effected in the apparatus represented by Figs. 100 and 101, showing the arrangement used in Freiberg for the extraction of silver.

The tubs (*a*) used for the lixiviation, stand in a raised apartment; each of them being provided with a filtering apparatus. On the bottom is laid a wooden cross, upon which rests a perforated disc of board; on this is placed a uniform layer of twigs; and lastly, a linen cloth is brought above this layer, and made tight against the walls of the vat, by being stretched upon a hoop. These tubs are filled with about 6 cwts. of matt, and moved on the waggon (*d*) by means of the tramway (*c*) and the cross rails, to their proper place at the gallery (*b*). The trough (*e*) is situated above the tubs; it contains the concentrated solution of common salt, receiving it from the reservoir *f*, which again is fed from the reservoir *x*. The salt water is heated by steam, and conducted hot upon the powder in the tubs. The fluid coming into contact with the finely-divided chloride of silver dissolves it, and carrying it through the filter, flows off by

\* Ibid., 1856, p. 97; 1862, p. 439. LORENZ, Stammbaum zu den Freiburger Hüttenprocessen, 1861.

FIG. 100.

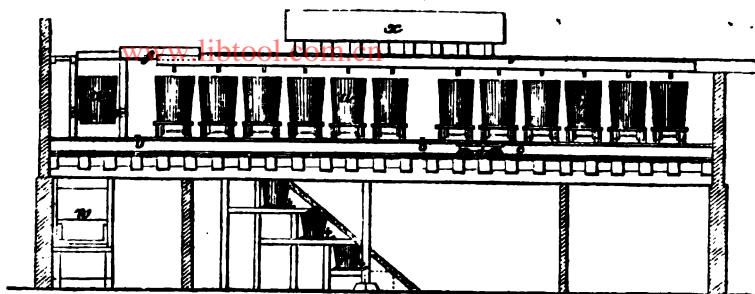
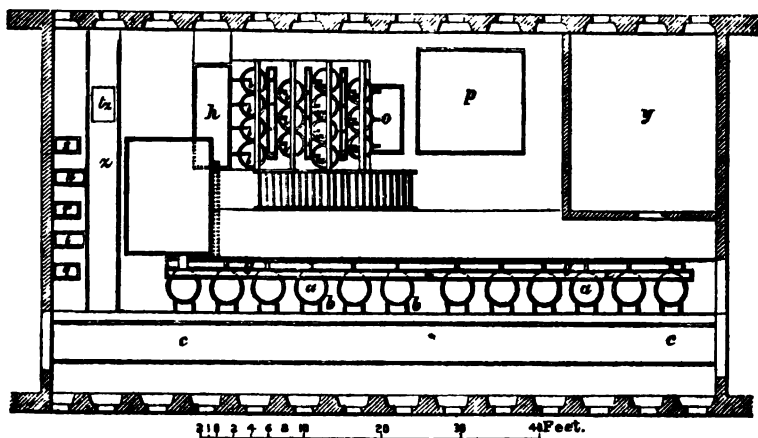

FIG. 101.



the trough *g* into the basin *h*, which is situated on the topmost level of the precipitation apparatus. The solution is then conducted from *h*, into the four tubs (*i*), in which the silver is precipitated by cement copper. The cement copper is placed in the tubs upon a filter similar to that with which the tubs for lixiviation are provided. The fluid then, by means of the trough, enters the next tubs, which also contain copper as a means of securing the precipitation of all the silver, and from these falls into the tubs *m* and *n*, which are filled with iron for the precipitation of copper; at last the fluid is conducted into the basin (*o*), which also contains iron for precipitating all the copper, and it is then raised by means of pumps into the reservoir (*p*).

When the tubs (*a*) have been lixiviated they are placed by means of the waggon (*d*) upon the tramway (*z*) in order to wash the residue in the tubs. The basin *s* contains pure water; *r* contains water resulting from the first washing with pure water; and *q* contains the fluid *r* after having been again used for washing. The tub *a* is now first filled with liquid from the basin *q*, and the resulting liquid is conducted into the trough *g*. The residues are next washed by the liquid in *r*, and the resulting liquid is collected in the basin *t*, and lifted by means of a pump into *q*. The third lixiviation is effected by pure water from the basin *s*, and the resulting liquid is collected in *u*, and pumped from here into *r*. The tub (*a*) is next carried to the apparatus (*v*), by means of which it may be tipped over, the residues falling upon the table *w* by the opening *tz*; *y* is a place for washing the cement silver.

The lixiviation is effected in three periods: the first with concentrated salt solution takes 10 hours; the second is carried on also with concentrated solution, and for about the same time. This second period is considered finished when a copper plate put into the solution no longer becomes white. The third lixiviation is effected by cold water, as already stated.

The following products result from the lixiviation and precipitation process:—

*a.* **Residues**, containing between 40 and 65 per cent of copper, and some silver. When found to contain more than 0.03 per cent of silver they are returned to the reverberatory furnace, re-roasted, and again lixiviated; when containing less than 0.03 per cent they are at once fused for the production of copper.

*b.* **Cement Silver**, in the form of a fine crystalline powder that collects in the tubs *i* and *l*. This is removed about every eight days, cleared of its particles of copper by a treatment with dilute hydrochloric acid, and placed in a vat, where it is washed by allowing water occasionally to flow over it. It is then removed from the vat, pressed into small balls, thoroughly dried, and taken to the refining department.

*c.* **Cement Copper** from *m*, *n*, *o*; this is used for precipitating the silver.

*d.* **Liquid free from Copper and Silver**, in the basin (*p*) in which part of the iron contained in it separates as a basic salt. It is from time to time purified from its sulphate of soda by crystallisation, and then again used for lixiviation.

The results of Augustin's process at Freiberg during the first six months of 1862 were as follows:—

By the process were treated—

1006·1 cwts. of copper matt, containing—  
0·2412 per cent of silver, and 64·98 per cent of copper.  
21·5 cwts of cement copper, containing—  
0·5306 per cent of silver, and 61·48 per cent of copper.

For the precipitation of silver were used—

1·5 cwt. of cement copper, containing—  
1·06 per cent of silver, and 86 per cent of copper.  
The lixiviation was effected in 84 days.  
In one day 11·97 cwts. of copper matt were worked.

For the oxidising roasting of 5 tons of copper matt, residues, &c., were consumed—

65·93 cwts. of slate coal, and 1·72 cubic feet of cinders.

Causing an expense per cwt. of—

5·8d. for fuel.      3·8d. for wages.      3·3d. for sundries.

For the chlorinating roasting of 5 tons were used—

5·352 cwts. of common salt.      50·67 cwts. of slate coal.  
1·37 cubic feet of cinders.

Causing an expense per cwt. of—

2·7d. for salt.      4·4d. for fuel.      2d. for wages.

Five tons consumed in the lixiviation process—

6·617 cwts. of salt.      38·48 cwts. of slate coal.  
0·9731 cwt. of wrought iron.

Causing an expense per cwt. of—

3·3d. for salt.      1·9d. for fuel.      9·6d. for wages.  
0·06d. for iron.

In the desilverisation of the residues still containing silver, of such residues were worked—

440 cwts. = 42·81 per cent.

Five tons required for roasting—

1·16 cwts. common salt, and 26·27 cwts. slate coal.

Causing an expense per cwt. of—

0·59d. for salt.      2·3d. for fuel.      0·69d. for wages.

Five tons consumed at the lixiviation—

1·36 cwts. salt, and 7·78 cwts. slate coal.



## Costing per cwt.—

0·6gd. for salt.                      0·4d. for fuel.                      1·5d. for wages.  
0·0rd. for wrought iron.

In the smelting of the residues there were worked up in  
11 days—

1100 cwts. of residues.                      451 cwts. of copper matt.  
54·8 cwts. of cement copper.                      32 cwts. of copper dross.

## Five tons of melting mass consumed—

38·001 cwts. of copper matt.                      87·314 cwts. of slate coal.  
2·98 cubic feet of cinders.

For the modification smelting of raw copper slags were  
consumed—

950 cwts. of slags.                      30·5 cwts. of dross.

## Five tons of slag and dross consumed—

101·519 cwts. of slate coal.                      1·825 cwts. of fluor spar.  
31·269 cwts. of quartz.

## The resulting raw copper contained—

0·04 per cent of silver, and 98·4 per cent of copper.

## The modified slag contained—

3 per cent of copper.

At the reducing and smelting of slags were consumed for  
every 5 tons of smelting mass—

187·97 cwts. of slate coal.                      3·44 cubic feet of cinders.  
1·757 cwts. of fluor spar.

## Costing per cwt.—

A total of 3s. 10d.

The total expense per 1 cwt. of the whole smelting mass  
amounted to—

3s. 7d. at the extraction.                      1s. 7d. at the smelting.  
0·08d. at the refining.                      Total 5s. 2·08d.

*Yield of Metal.*

Of the silver contained in the mass under treatment were  
collected—

In fine silver, 79·491 per cent.                      In cement copper 0·951 per cent.  
In marketable intermediate products 4·980 per cent.  
In fume 1·314 per cent.                      In residues 3·976 per cent.  
Total loss of silver 9·288 per cent.

The loss of silver in the first six months of 1862 amounted  
to—

13·57 per cent.

This amount was contained in the following proportions:—

In raw copper 9·82 per cent.                      In copper matt 2·81 per cent.  
In slags 0·41 per cent.

The copper was obtained from the substances under treatment as follows :—

In raw copper 72.37 per cent.	In cement copper 0.271 per cent.
In copper matt 19.833 per cent.	
In marketable intermediate products 1.044 per cent.	
In smoke 0.396 per cent.	In slags 2.835 per cent.
Loss of copper 3.23 per cent.	

### Augustin's Process for the Treatment of Speiss.

The treatment of speiss is generally very difficult, on account of antimony and arsenic contained in it, but it has occasionally given satisfactory results,—at the Stephanshütte, in Hungary, for instance. Ferientsik\* extracted the silver completely, and 87 per cent of the copper from argentiferous speiss. The hot solution of common salt employed for lixiviating the silver contained some chloride of iron, and the residues contained 4 per cent of copper. A loss of about 4 per cent of silver took place when treating this speiss by the amalgamation process.

The argentiferous speiss, containing 44 per cent of antimony, 27 per cent of copper, 20 per cent of iron, 3 per cent of sulphur, 2 per cent of arsenic, bismuth, cobalt, nickel, silver, and gold (only 0.0032), is roasted at a low temperature in quantities of 9 cwts. for 5 hours on the upper hearth of a double roasting furnace, and afterwards on the lower hearth for the same time; it is then lixiviated. The residues are now roasted for about 5 hours in admixture with some iron pyrites or matt, and again lixiviated. The resulting residues rich in antimony, and containing from 2 to 4 per cent of copper, are smelted with from 30 to 50 per cent of pyrites for the production of copper matt and a speiss rich in antimony; if the copper matt contains about 7 per cent of copper it is added to the speiss while roasting.

The extraction of copper will be imperfect if the speiss has only been once roasted.

\* Bericht üb. d. 2. Versammlung v. B. u. H. in Wien., 1862, pp. 25, 82. B. u. h. Ztg., 1864, p. 323.

**Augustin's Process for the Treatment of Black Copper.**

Black copper suitable for this treatment must be nearly free from lead, and must contain a little antimony, and not too much copper; black copper must also contain these substances to make it fit for the amalgamation process.

When the copper contains much lead, it requires a purifying smelting, as well as a lixiviation of the chloride of lead which will be formed at the chlorinating roasting before the complete chlorination of the silver. These very expensive operations may be dispensed with if it is possible to mix plumbiferous black copper with a greater quantity of black copper free from lead; this is done at Tajova\* when argentiferous copper ores are smelted with an addition of 80 per cent of lime. The mixture then contains 12 per cent of copper, and 0.045 per cent of silver, and produces 24 per cent of matt, containing 45 per cent of copper, and 0.14 per cent of silver, besides 3 or 4 per cent of antimonial speiss containing 80 per cent of copper and 0.25 per cent of silver. The matt is now roasted 11 or 12 times, and smelted in admixture with 10 or 12 per cent of raw speiss, producing from 40 to 43 per cent of black copper, containing from 80 to 85 per cent of copper and 0.25 to 0.26 lb. of silver, besides 20 per cent of matt.

An analysis of such black copper free from lead shows the following composition:—

Cu . . . . .	86.60 per cent.
Ag . . . . .	0.25 „
Fe . . . . .	7.40 „
Sb . . . . .	5.30 „

Plumbiferous black copper of the following composition is also produced at Tajova:—

	i.	ii.	iii.
Ag . . . . .	0.28	0.21	0.49
Cu . . . . .	80.01	79.50	77.17
Pb . . . . .	10.06	11.40	11.10
Fe . . . . .	1.40	1.57	2.85
Sb . . . . .	8.10	6.41	0.23

\* B. u. h. Ztg., 1859, p. 286; 1861, p. 326; 1862, pp. 18, 39; 1864, p. 102. Oesterr. Ztschr., 1860, No. 36; 1861, Nos. 9, 16.

These are mixed together in a proper proportion, causing the loss of silver at its extraction to amount to only 5 per cent, instead of the loss of 17 per cent occasioned when purifying the plumbiferous copper.

In order to reduce the black copper to a fine state of division, it is melted, ladled out in a pasty state, and spread upon a cold cast-iron plate, where it is divided as much as possible by means of a wooden mallet, then pounded, ground, and sifted; 7 cwts. may be prepared in about 12 hours.

The powdered black copper is next mixed in the proportion of 100 lbs. of plumbiferous copper to 300 lbs. of copper free from lead, and roasted in a double roasting furnace, with an addition of about 10 per cent of powdered salt. It is kept for about 5 hours on the upper hearth of the furnace at a red heat, during which time it is repeatedly turned. It is afterwards roasted for about two hours on the lower hearth, at a higher temperature, chiefly in order to decompose the antimonial salts. If the mass becomes darker at this roasting period, some coal or wood rubbish is added, raising the temperature so much that no new fuel need be put on the grate till within about  $1\frac{1}{2}$  hours of the end of the operation. The length and the temperature of the roasting depend on the quality of the roasting material, and must be determined by minute observations of the roasting process, as well as by a combination of the results obtained by the roasting and extraction process.

After cooling, the roasting mass is sifted, and the fine powder which passes through the sieve is submitted to the extraction process, while the powder remaining on the sieve is ground and roasted again. The roasting mass must be moistened to prevent any loss during sifting.

The roasting mass is lixiviated in a similar apparatus, and in the same manner as adopted at Freiberg, described at page 368. The resulting residues must not contain more than 0.009 per cent of silver; should they contain more they are kept for some time in a very warm place, where they will become more perfectly chlorinated by themselves, when they are to be again lixiviated.

The precipitation of the silver and copper is also effected in the manner adopted at Freiberg.

In the years 1859 and 1860, 79·69 per cent of silver were produced direct, 15·35 per cent remained in the profitable products which were worked up again, leaving a loss of 4·96 per cent. The extraction of 1 lb. of silver cost £1 6s., and the cost for treating 1 cwt. of black copper, containing 77·22 lbs. of copper and 0·339 lb. of silver, amounted to 8s.

### **Ziervogel's Method of Extracting Silver with Warm Water.**

This is the simplest and cheapest of all the different known processes for extracting silver, and is based upon the transformation of the silver contained in the substance under treatment into sulphate of silver, which is then lixiviated by hot water containing some sulphuric acid, and precipitated from this solution by means of copper. The formation of sulphate of silver is effected in the roasting process by the evolution of sulphuric acid, in a gaseous form, from sulphates which have been generated from other sulphides associated with the sulphide of silver.

The perfection of the desilverising depends solely on the result of the preliminary roasting, which is one of the most delicate operations in the metallurgy of silver.

The amount of sulphide of copper and iron present is of essential influence. Hitherto this process has only been carried on profitably with the copper matt of Mansfeld, which contains about 80 per cent of sub-sulphide of copper ( $\text{Cu}_2\text{S}$  with about 65 per cent of copper), 0·4 per cent of sulphide of silver, and only 11 per cent of sulphide of iron. If this matt is roasted, proto-sulphate of iron is first formed, and afterwards per-sulphate, which by the further roasting becomes decomposed into peroxide of iron and free sulphuric acid. At this period also the  $\text{Cu}_2\text{S}$  is converted into sulphate of copper, partly by the oxygen of the atmosphere, but chiefly by the liberated sulphuric acid. If the temperature is now increased, the sulphate of copper becomes in its turn decomposed into oxide of copper and sulphuric acid gas; and the sulphide of silver is now transformed into sulphate

of silver, chiefly by the sulphuric acid derived from the sulphate of copper.

If the sulphide of iron predominates in the ore, and only a little sulphide of copper is contained in it, the formation of sulphate of silver will be imperfect, and rich residues will result in the subsequent lixiviation process; however, the presence of a certain amount of iron in the matt is essential, otherwise too much time is required for the formation of sulphate of copper.

The existence of other foreign substances in the matt is injurious to the yield of silver,—sulphide of lead and antimony, for instance,—as they cause a caking of the roasting mass. Zinc, antimony, and arsenic facilitate a volatilisation of silver, and also give rise to the formation of antimoniate and arseniate of silver, which is decomposed with great difficulty by sulphuric acid gas. If the decomposition takes place at a higher temperature, metallic silver will be formed, liable to volatilisation.

The presence of metallic copper in the matt is also disadvantageous, as the silver in it cannot be extracted.

According to present experience, Ziervogel's process is only applicable to substances as pure as the copper matt at Mansfeld, and is not fit for treating most of the silver ores, as they either contain antimony, arsenic, lead, and zinc in larger quantities, or do not contain sulphide of copper.

Ziervogel's process was carried on at Mansfeld for some time together with Augustin's process, in order to institute a thorough comparison between them, and Ziervogel's method was thus proved to be the simpler and cheaper. The cost of roasting and manipulation is less, the lixiviation is effected quicker, and the yield of silver is increased.

The quantity of silver in the refined copper, produced from the desilverised residues, which were treated partly by the amalgamation process and partly by Augustin's process, was from 0.0388 to 0.0631 per cent in the years 1846 to 1849, and that resulting from Ziervogel's process only 0.0215 per cent in 1861.

The loss of silver on every 100 parts of that contained in the substance under treatment, amounted in the amalgama-

tion process to 9·4722 per cent, in Augustin's process to 7·933 per cent, and in Ziervogel's process to only 0·8025 per cent.

Ziervogel's process requires the following operations:—

**a. Fine Division of the Copper Matt.**—The copper matt is first concentrated and granulated, and then contains on an average 80 per cent of  $\text{Cu}_2\text{S}$ , being composed as follows:—

Copper . . . . .	65 per cent.
Sulphide of iron . . . . .	11 „
„ lead . . . . .	2 „
„ zinc . . . . .	5 „
„ manganese . . . . .	0·2 „
„ nickel . . . . .	0·5 „
„ cobalt . . . . .	1 „
„ silver . . . . .	0·4 „

It is then ground very fine between granite stones, and sifted.

**b. Roasting.\***—This is effected in double roasting furnaces, represented by Figs. 102, 103, 104, and 105. *a* is the lower hearth formed of fire-bricks, resting upon a layer of loam 6 inches thick; *b* the flue, provided with a lid (*c*) at the level of the condensation chambers (*d*), which communicates by the vertical flue (*e*) with a system of horizontal flues (*f*); these are covered with iron plates, which serve for drying the desilverised residues. The escaping gases are at last conducted into a chimney, 154 feet high, which is connected with 7 roasting furnaces; *g* is the ash-pit connected by the opening *h* with the channel *l*, which runs beneath all the furnaces, and communicates with the atmosphere. The opening *h* may be opened and shut by the lid *i*, which is movable by means of *k*; the admission of air beneath the grate may be regulated by the lids *e* and *i*, according to requirement; *m* is the working door for the lower hearth, provided with a support for the tools; *n* is the channel leading to the upper hearth, serving for transferring the roasting mass from the upper to the lower hearth, and

\* PLATTNER'S Röstprocesse, 1856, pp. 20, 140. B. u. h. Ztg., 1863, p. 37. Preuss. Zeitschr., xi., 95. Oesterr. Zeitschr., 1864, p. 218.

FIG. 102.

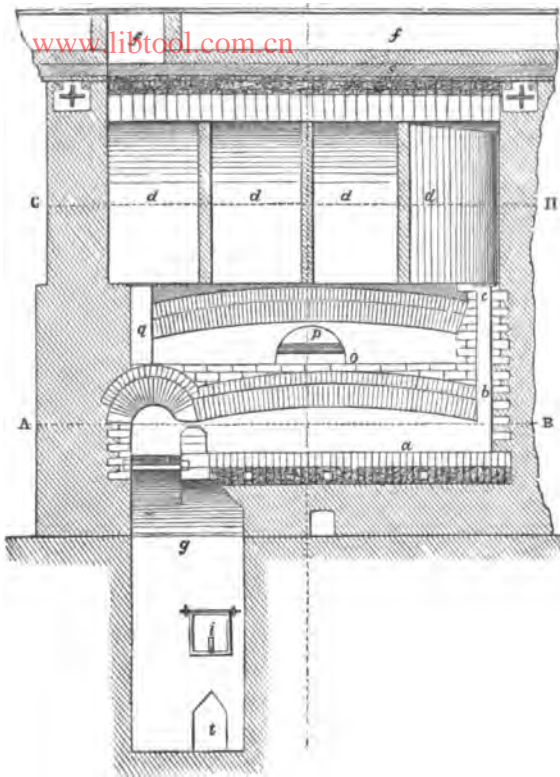

FIG. 103.

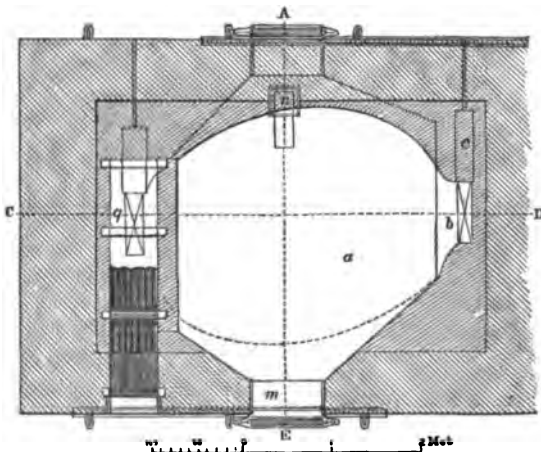



FIG. 104.

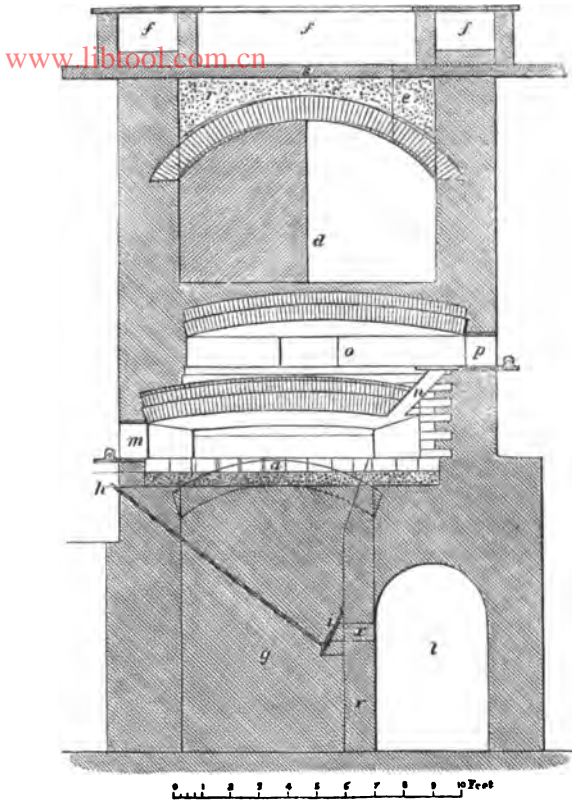
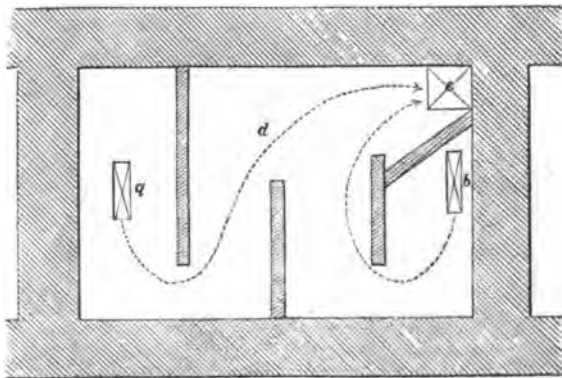

FIG. 105.



closed during the roasting process by means of an iron plate; *o* is the upper hearth; *p*, the working door for the same; *q*, flue conducting to the condensation chambers; *r*, filling of gravel; *s*, plates of sand-stone; and *t*, opening for removing the ash, always kept closed.

In these furnaces the area of the grate is  $12\frac{1}{4}$  square feet, the opening for the flame above the fire-bridge is 2'08, the hearth is 75, and the flue for the escaping flame 1 square foot in area. Half of the area of the working doors likewise admits air.

One charge for the roasting process consists of—

- 5 cwts. of finely-divided copper matt;
- 70 lbs. of rich residues, which have been incompletely de-silverised;
- 25 „ „ lixiviated roasting mass, which have become caked in the roasting process.

Besides a small quantity of furnace bottoms.

According to Steinbeck, the raw mixture contains, without taking into consideration the amount of oxygen,—

Sulphur . . . . .	19'326
Copper . . . . .	58'006
Iron . . . . .	9'182
Lead . . . . .	2'480
Silver . . . . .	0'2856
Zinc . . . . .	4'312
Manganese . . . . .	0'1527
Nickel . . . . .	0'4395
Cobalt . . . . .	0'836
Insoluble residues . . . . .	1'084

The roasting process may be divided into three periods:—

*Period I.*—The roasting mass is properly mixed and spread out on the upper hearth of the roasting furnace which has been previously heated, and left untouched for about half an hour in order to dry; about 5 lbs. of brown coal are now thrown upon it, and the mass is worked up with a rake for about one hour.

Any parts of the roasting mass which may have become lumpy are broken down by means of a hammer; mixtures poor in iron are less inclined to cake than those rich in iron, as they are chiefly generated by the transformation of the

protosulphate of iron into basic persulphate of iron. These cakes are more easily divided than those formed during the last period, which consist of semi-fused sulphides.

As the atmospheric air admitted by the working door passes towards the flue, the roasting progresses faster here than on the opposite side, therefore it is necessary to change the position of the roasting mass after it has been raked for about one hour. The mass is now raked again for one hour, then moved and raked for about  $2\frac{1}{2}$  hours alternately by the two attending workmen; 25 lbs. of brown coal are now mixed with the roasting mass, which is brightly glowing, and emitting burning gases; it is then removed through the channel (*n*) to the lower hearth; the whole operation occupying about  $5\frac{1}{2}$  hours.

According to the investigations of Plattner\* and Steinbeck, all the sulphides, excepting sulphide of silver, are at this period first transformed into sulphates; towards the end of the period, sulphates of iron and zinc are again decomposed; sulphate of zinc being formed more abundantly than sulphate of iron. The sulphates of copper, nickel, cobalt, and manganese are not decomposed.

The roasting process is commenced at a moderate temperature, which, after  $1\frac{1}{2}$  hours, rises as high as  $425^{\circ}$  C., causing the above-mentioned caking. After two hours only 37 per cent of the sulphur, originally combined with the metals, is present, and not more than 5 per cent at the end of the period; sub-oxide of copper is formed by the reaction of the atmospheric air and the sulphuric acid gas generated by the decomposition of the sulphate of iron upon the undecomposed sulphide of copper, which sub-oxide of copper more nearly approaches the state of oxide of copper in proportion as the greater part of the metallic sulphides are decomposed. If sub-oxide of copper and a compound of protoxide and peroxide of iron, formed by an insufficient admittance of air, remain in the roasting mass during the later periods, they will have a partly decomposing reaction upon the

\* PLATTNER'S Röstprocesse, 1856, pp. 20, 120, 140.

sulphate of silver which has been formed, increasing the volatilisation of silver; the sub-oxide of copper would also cause the precipitation of metallic silver during the lixiviation of the sulphate of silver by water.

*Period II.*—No fuel is thrown on the grate during this period; the roasting mass is spread out upon the lower hearth, which is still red hot, and is there raked continuously for about an hour to prevent too great a caking of the mass. The flue is kept closed during this operation to avoid a further rise of the temperature by a rapid oxidation of the remaining sulphur, and prevent a combustion of the brown coal mixed up with the roasting mass, by the oxygen of the atmospheric air. In half an hour the gradually glowing brown coal is consumed, and the position of the roasting mass is changed after it has been raked for an hour. The flue is now opened, and oxidation is accelerated by the admission of atmospheric air for about  $1\frac{1}{2}$  hours; thus the mass cools gradually, becoming nearly dark.

In order to ascertain the end of this period, a sample is taken from the middle of the hearth, cooled on a brick, the cakes are separated from the fine powder, which is spread out upon a porcelain plate, and water is made to permeate it. The resulting liquid serves for ascertaining the state of the process. If it is of a pure blue colour, like sulphate of copper, and if the addition of common salt produces some little precipitate, indicating that the formation of sulphate of silver has commenced, the second roasting period is considered finished; but if the lixiviation shows an impure greenish colour, indicating the presence of sulphate of iron, the roasting must be continued somewhat longer; on an average it requires  $2\frac{1}{2}$  hours.

At the commencement of this second or oxidising period, the flue having been closed, a decomposition of the neutral sulphates takes place by the reaction of the brown coal, forming sulphurous acid and basic salts; whilst the amount of sub-oxide of copper is not lessened. When the flue is opened a more complete roasting of the metallic sulphides will occur, the sulphate of iron, which is required for the formation of sulphate of silver, almost completely disappears,

and the sub-oxide of copper becomes converted into oxide of copper. Therefore, at the end of this period, the roasting mass contains free oxides of iron and copper, basic salts, chiefly of peroxide of iron, oxides of copper and zinc, neutral sulphates of copper, zinc, and manganese, and a little oxide of silver and undecomposed sulphide of silver.

*Period III.*—Oak, beech, or birch wood, but not fir wood, are used at this period for keeping up the fire, in order to avoid a smoky flame, which would reduce the free oxide of copper to sub-oxide. The flame is conducted from the grate beneath the arched roof to the flue without coming in contact with the roasting mass. The draught of air is regulated by the lid (*i*), according to the state of the weather; the lid is usually kept half open.

During this period the roasting mass is continuously and thoroughly worked up with a rake; it becomes of a dull red heat after about one hour, but later of a full red heat, showing only a few caked clods and lumps, which are not broken up, but become more compact the higher the temperature rises. If the mass is now worked by the rake for  $1\frac{1}{2}$  hours more, alternately by the different workmen, the part lying on the fire-bridge is usually quite roasted. When lixiviated, a sample will give a light blue coloured liquid in which common salt will form a dense precipitate of chloride of silver. The mass is then turned and moved about as the part away from the flue is unfinished, and it is raked again until a sample shows that it is finished, which is usually the case after another half-hour's working. If the roasting mass is overheated, sulphate of silver will also be decomposed, and the lixivium will appear quite colourless, as the sulphate of copper is then completely decomposed. The third period of roasting takes altogether about  $5\frac{1}{2}$  hours' time.

By raising the temperature at this period up to a light red heat, the sulphuric acid is expelled in the form of gas from the basic salts, chiefly from the sulphate of copper, less from the neutral salts. The sulphuric acid gas transforms the

sulphide of silver, of which scarcely any is yet decomposed, into sulphate of silver. Sulphate of zinc and manganese are only decomposed at a higher temperature than is admissible for the process, as otherwise metallic silver would be reduced from the sulphate of silver.

Steinbeck has found that the temperature of the lower hearth at the beginning of the second period is from 500 to 550° C., which decreases towards the end of the period to 425° C., and rises again towards the end of the third period to 750° or 770° C.

The loss of silver during roasting amounts to 7.06 per cent; 91.736 per cent of the silver is contained in the sulphate of silver, and 1.20 per cent in the residues. The volatilisation of silver is effected partly mechanically by the formation of dust, and partly as oxide of silver at higher temperature, which again is decomposed at a lower temperature into silver and oxygen. This is proved by the circumstance that the smoke in the chambers contains different amounts of copper and silver according to whether it is deposited nearer or further from the furnace, which would not be the case if it were all formed mechanically. While the richest copper matt only contains 0.606 per cent of silver at the highest, smoke found in the flue between the lower hearth and condensation chambers contains 0.7849 per cent of silver.

The smoke resulting from the roasting furnaces is annually removed in quantities of 12½ tons. That from the flues contains 9.3 per cent of copper and 0.073 per cent of silver; that from the chambers, 22.1 per cent of copper and 0.085 per cent of silver; and that from the channels, 18.075 per cent of copper and 0.063 per cent of silver. It is worked in cupola furnaces for the production of copper matt. The smoke deposited at the deepest point of the chimney which serves for the different roasting furnaces, contains from 9 to 10 per cent of selenium. About 2 cwts. of this smoke are collected annually, and used for the production of selenium in the laboratory at Eisleben. It yields 8.333 per cent of raw, and 6.66 per cent of pure selenium, 15 lbs. in all.

According to Kemper, this smoke is composed as follows :

CaO, SO <sub>3</sub>	. . . . .	1'78
Fe <sub>2</sub> O <sub>3</sub> , SO <sub>3</sub>	. . . . .	10'73
Al <sub>2</sub> O <sub>3</sub> , SO <sub>3</sub>	. . . . .	2'08
CuO, SO <sub>3</sub> + HO	. . . . .	25'89
ZnO, SO <sub>3</sub> + HO	. . . . .	1'55
3HO, SO <sub>3</sub>	. . . . .	11'02
HO	. . . . .	21'84
Insoluble residues	. . . . .	23'12
Pieces of brick	. . . . .	2'60

Besides this smoke the bottoms of the lower hearth are worked up again. They contain 53'8 per cent of copper and 0'1225 per cent of silver. Every week the bottoms are removed mechanically, after being softened by heating with brushwood, when they are lixiviated, and the residues added to the roasting mass. From 2 to 2½ cwts. of bottoms result every week from one furnace.

10'2 cwts. of copper matt are roasted every 12 hours in 2 charges, consuming about 3,000 pieces of wood and 5 cwts. of brown coal per 5 tons of powdered matt. From 5 tons of matt result 4'9 per cent of roasting lumps and 1'22 per cent of furnace bottoms. In the years 1856 to 1860, the expense of roasting 5 tons was £7 8s. 6d.

The roasting mass, containing about 91 per cent of silver in a soluble state, and 1'2 per cent of silver in an insoluble state (which would remain in the residues), is cooled to 70° R., and put in quantities of 5 cwts. into the tubs (A) (Fig. 106), ten of which are at hand. The tubs are furnished with two bottoms, the upper one ¼ of an inch thick, and standing 2 inches above the lower bottom, being perforated with holes half an inch in diameter. The arrangement for filtering is like that used in the lixiviating process by salt water (page 370). *b*, is a leaden tube 2 inches wide, and coated with oakum, by means of which from 2 to 3 cubic feet of pure water, heated to 70° R., are made to play upon the roasting mass, which is covered with a bundle of oakum for a better dispersion of the water. When lixivium containing silver begins to flow out of the tube on the lower part of the tub, the flow of water from the tube *b* is stopped by the cock, and instead the tube *a*, 4 inches wide, is opened, admitting



FIG. 106.

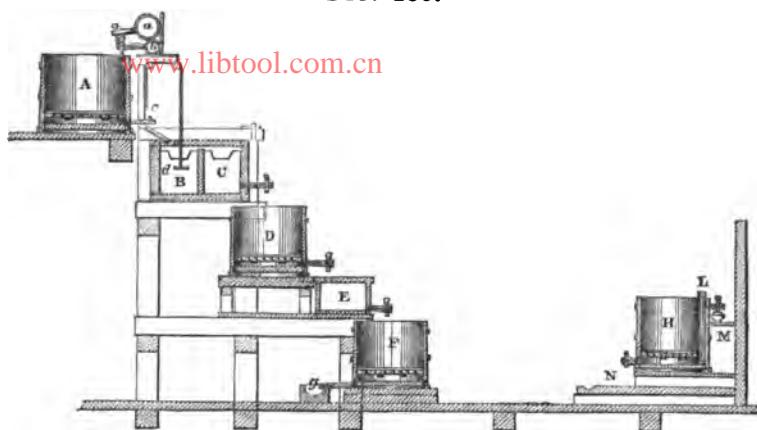

water heated to  $70^{\circ}$  R., and acidulated by an addition of sulphuric acid, which runs into the tub (A) in quantities of about 11 cubic feet every two hours, until an assay with common salt no longer produces a precipitate in the liquid flowing off. The solution of sulphate of silver flows by *c*, into the first compartment (B) of a large box 30 feet long, 2 feet broad, and  $1\frac{1}{2}$  feet high; it enters the compartment C above the division board, and it then flows by means of 10 cocks into the ten tubs D for the precipitation of the silver. The long box for clarifying the liquid, as well as all other reservoirs, are provided with a float (D) indicating the height of the liquid.

Upon the filter of the tubs for precipitation (D) a layer of cement copper is placed in small pieces about 3 inches thick and 10 lbs. in weight, and above this about 20 copper bars, 14 inches long, 5 inches broad, and 1 inch thick, each weighing about  $2\frac{1}{2}$  cwts. The solution on leaving D contains but very little sulphate of silver, and enters the trough E 15 inches broad and 6 inches deep, coated with lead, and provided with a layer of small pieces of copper. It then flows into the tubs F, which also contain copper, about 18 lbs., in a granular state, and 1 cwt. in bars; on these very little silver is precipitated. The desilverised fluid having a temperature of about  $45^{\circ}$  R., is now conducted by the gutter (G) into a



leaden reservoir, whence it is raised by means of a pump into a leaden pan capable of containing 70 cubic feet, and after being heated in it to 70° R., it is used again for lixiviation. A vessel containing sulphuric acid diluted with 8 times its quantity of water is placed above the pan, and from it 30 drops fall into the pan every minute, amounting to about  $\frac{1}{2}$  lb. of sulphuric acid to each charge.

The addition of acid prevents the separation of basic salts, and facilitates the solution of sulphate of silver. The sulphate of iron which will be formed reacts upon any metallic silver that may be present in such a manner that sulphate of silver is formed as well as sulphate of iron.

The precipitated silver is removed from the tubs (D) every 24 hours, and the filters are removed every eight days.

The resulting cement silver is chiefly contaminated with metallic copper and gypsum. It is reduced to powder in casks by means of wooden pestles, and separated from the small copper lumps by washing on dishes. It is now lixiviated for about seven days with sulphuric acid diluted with eight times its quantity of water, in the nine tubs (H), to remove the remaining copper and gypsum as much as possible. It is afterwards washed with hot water. The liquid used for washing is raised by the gutter L, and conducted by the gutter M, first over copper, and at last over iron. The washed silver of about 0.865 fineness is formed into blocks, dried in a separate furnace, and refined in a reverberatory furnace.

When containing less than 0.03 per cent of silver, the residues are mixed with clay and smelted for the production of black copper; if too rich, they are roasted and lixiviated again.

The desilverised liquid is purified once a year from the copper it contains by conducting it over iron. The precipitated cement copper is divided into two lots by repeated washing and decantation. The coarser cement copper, which is also the purest, is used for the precipitation of silver, and the other copper, being contaminated with basic salts, is worked for the production of black copper.

The gypsum which crystallises in the precipitation tub is

removed every fortnight, and smelted together with the smoke for the production of matt.

12 or 14 lbs. of silver are produced in 12 hours.

On page 191 of his "Rudimentary Treatise on the Metallurgy of Silver and Lead," Dr. Lamborn gives the following table:—

	Cost	Amount of silver left in copper.
	£ s. d.	Per cent.
Extracting the silver by liqutation from 1 cwt. of copper	1 10 0	100
" " amalgamation "	0 16 6	058
" " Augustin's method "	0 13 6	058
" " Ziervogel's method "	0 11 6	029

### Extraction of Silver by Means of Hyposulphites.

Several methods have been proposed for the extraction of silver by this plan. Drs. Percy\* and Hauch† suggest the conversion of the silver contained in the ores and matt into chloride of silver by roasting with common salt, and its subsequent extraction with hyposulphite of soda. Patera‡ first carried out this method on a large scale, and with suitable modifications, in Joachimsthal.

Hyposulphite of soda is preferable to common salt for dissolving chloride of silver, as it dissolves greater quantities in a cold and diluted state than a hot concentrated solution of salt is capable of doing, forming a double salt of hyposulphite of silver and soda. 1 part of chloride of silver is dissolved by about 68 parts of common salt, while only 2 parts of hyposulphite of soda are required for dissolving this quantity of silver.

The operation is performed in a shorter time by hyposulphite, the extracted silver is contained in much less liquid, which being dilute is not so liable to pass through the vessels as are hot concentrated solutions of salt, which also

\* DINGLER'S Polyt. Journ. Band. 115, p. 281. Polyt. Centralbl., 1850, p. 1195. B. u. h. Ztg., 1849, p. 640; 1850, p. 683.

† Russeger's Reisen, iv., 725. Jahrbuch der Geolog. Reichanstalt, 1853, No. 3, p. 544.

‡ Ibid. 1851. No. 1, p. 156; No. 3, p. 52. B. u. h. Ztg., 1860, p. 487; 1861, pp. 60, 222; 1863, p. 31; 1864, p. 103. Preus. Zeitschr., 1862, x., p. 166. NEUMANN, die Extraction, 1863, p. 72. Oesterr. Zeitung, 1860, Nos. 11, 12, 17, 39.

deposit basic salts when exposed to the atmospheric air, and obstruct the filters; if the solution of hyposulphite of soda is too concentrated it will dissolve many foreign metallic oxides, and contaminate the silver.

In Australia\* the solution of hyposulphite of soda is employed in a heated state.

Fresh hyposulphite of soda is only required for the first lixiviation, and it is afterwards used again.

As copper is also attacked by hyposulphite of soda, sulphide of sodium is used for precipitating the silver; the sulphide of sodium is prepared by smelting sulphate of soda with carbon; the resulting mono-sulphide of sodium is then dissolved in water and boiled with sulphur in order to form a poly-sulphide of sodium. If the sulphide of sodium is used for precipitating silver from its double salt, and is not in excess, the hyposulphite of soda will be reformed, and any surplus of sulphide of sodium will also be transformed into hyposulphite of soda when exposed to the air for a longer time.

Poly-sulphide of sodium is preferred to the mono-sulphide for precipitating purposes, as sulphur becomes separated in the precipitation process, rendering the precipitate lighter, and more clearly indicating the end of the precipitation; mono-sulphide always contains some coal, which causes the moment of precipitation to be less distinct.

As this method requires a chlorination roasting, like Augustin's process, Patera has introduced some suitable modifications in the roasting process, which enable the silver ores of Joachimsthal, containing cobalt, nickel, arsenic, antimony, and zinc, to be advantageously treated. The ores are first roasted with the application of steam, afterwards with an addition of common salt and sulphate of iron, and likewise with an admission of steam. The sulphuric acid from the sulphate of iron drives off the chlorine of the salt, then the muriatic acid, which has been formed by the admission of steam, will, it is supposed, react energetically upon arsenic and antimony, causing their removal and also facilitating

\* B. u. h. Ztg., 1864, p. 346.

the chlorination of the silver. The loss of silver, which in the usual roasting amounts to at least 10 per cent, is thus reduced to a minimum, which is essential in treating rich ores.

Patera's method has a disadvantage which the amalgamation and Augustin's processes have not; most of the operations are done by men, whilst the other two processes make more use of machinery, or are carried on by themselves; also, the consumption of fuel is nearly doubled by the application of steam. The roasting mass must be washed with water before the lixiviation with hyposulphite of soda is effected, as otherwise the consumption of sulphide of sodium would be too great, and the resulting sulphide of silver too impure. The precipitation requires great attention, and the resulting sulphide of silver still contains free sulphur; it may, in fact, be still considered as a rich silver ore.

As hyposulphite of soda dissolves chloride of silver so readily, and the loss of silver during the roasting process is so slight, this method is suitable for working the richest ores.

It is carried on at Joachimsthal as follows:—

Rich ores containing 0·4 per cent of silver and upwards, to the highest amount, are only coarsely powdered and roasted for four or six hours in reverberatory furnaces, with the application of steam. The earthy roasting mass is, when still hot, ground up with from 4 to 9 per cent of common salt, and, if necessary, with 2 or 4 per cent of calcined sulphate of iron, roasted at a moderate temperature, and with an admission of steam. The roasting is considered finished if a sample, after being extracted by hyposulphite of soda, does not retain more than 0·1 or 0·2 per cent of silver in its residues, whence it is inferred that the original ores contained from 0·4 to 4 per cent of silver. If they contain more, say from 8 to 10 per cent, they must be roasted for a longer time, about five or six hours or more, and then if the residue of a sample, after having been treated as described, contains from 1 to 2 per cent, one or two repetitions will reduce this amount to 0·1 or 0·2 per cent. The roasting mass is then sifted, moistened with water, and

allowed to remain some time; the chlorination of the silver is thus continued. When washed with hot water, the salts of iron, cobalt, nickel, zinc, copper, lead, and also a little silver will be dissolved. The solution is decomposed by lime-water, and the resulting precipitate added to the raw smelting.

The washed roasting mass is next treated with a cold and dilute solution of hyposulphite of soda, 1 cubic foot of which will dissolve 0.753 lb. of silver, and the solution of hyposulphite of soda is always regenerated upon the precipitation of the silver. The subsidence of the precipitate is facilitated by a perforated wooden disk moving up and down; the clear solution is then allowed to flow off, and the sulphide of silver is filtered in a canvas bag, pressed, dried, and washed with hot water, so as to extract the sulphate of soda it contains; it is then dried again, and, if containing 60 per cent of silver, heated in a muffle or in a retort, and the residue containing 80 per cent of silver is melted together with iron in a plumbago crucible, producing silver of from 0.940 to 0.960 fineness. This is again refined, and the matt which results at the same time, and containing up to 10 per cent of silver, is added to the roasting mass instead of sulphate of iron. The residues, smoke, &c., if sufficiently poor, are mixed with poor ores, and submitted to a concentration smelting; if richer they are given back to the extraction process. The yield of this process amounts to 88 per cent of silver, 1 or 2 per cent are lost, and the rest remains in the intermediate products; the loss becomes less in proportion as the wooden vessels cease to absorb any of the solution.

In 1862, the cost for materials and labour amounted to 8s. 6d. per cwt. of ore, and to 4s. 4d. per lb. of silver produced.

The residues containing more or less nickel and cobalt, together with ores poor in silver, are smelted in admixture with 10 per cent of pyrites, 12 per cent of pounded slags, and sufficient lime for the production of 16 per cent of matt. Ore containing 0.23 per cent of silver, and 3.4 per cent of nickel and cobalt, yields a matt containing 1.25 per cent of silver, and 17 per cent of nickel and cobalt. The matt is

then re-melted with an addition of sulphate of soda, moistened, and exposed to the atmospheric air, which causes an oxidation of the sulphides of sodium and iron, and converts the matt to a fine powder. 20 per cent of its soluble components are then extracted by water, as otherwise the sulphide of iron could only be decomposed with difficulty, on account of the presence of sulphate of soda. The remaining residue, containing 0.1 to 0.2 per cent of silver, is now smelted with arsenical and iron pyrites for the production of speiss and copper matt, and the speiss is liberated from the iron it contains by a refining smelting, and afterwards used for the extraction of cobalt and nickel.

The cost of this process is from 30 to 60 per cent lower than that of the smelting processes formerly used, owing to the saving of charcoal, as only cheap brown coal is used for roasting.

#### Extraction of Silver with Sulphuric Acid.

This method consists in treating argentiferous copper matt or black copper, which must be as free as possible from iron, with hot dilute sulphuric acid, which will dissolve sulphate of copper, while the silver remains in the residue. The residue is then desilverised by smelting it together with lead ores or with plumbiferous products; the wet way is seldom employed. The sulphate of copper is either boiled down and sold as such, or it is worked up together with copper matt for the production of copper. Bachmann\* advises that the sulphide of copper should be heated in retorts for the extraction of part of its sulphuric acid, and the residues smelted in cupola furnaces.

This method is chiefly advantageous when treating products containing a certain amount of lead, antimony, and arsenic. It is preferable to Augustin's process, as being cheaper, more quickly executed, and yielding more copper, silver, and gold. With regard to gold, this method is more effectual than all the other processes, either in the dry or wet way.

\* Oesterr. Ztschr., 1857, pp. 283, 289.

The following is a comparison of the liquation process with this method of extracting silver, as regards the loss of silver, and the expense:—

	Liquation.	Extraction with sulphuric acid.
Loss of silver . . . . .	28 per cent.	15 per cent.
„ copper . . . . .	20 „	12½ „
„ lead with regard to the quantity of black copper treated	104 „	10 „
Proportional expense of treatment	1.2 „	1 „
Selling price of 1 cwt. refined copper	£4 10s.	— „
Value per cwt. of the copper contained in the sulphate of copper	—	£5 8s.

The loss of silver in the extraction process with sulphuric acid, which is not inconsiderable, is caused by the antimonial and arsenical residues which are formed when employing impure sulphuric acid; 1 cwt. of copper produces nearly 4 cwts. of sulphate of copper.

It is generally more advantageous to treat black copper by this method than copper matt, as black copper only requires a refining previous to treatment for the extraction of its contained iron, which would otherwise contaminate the sulphate of copper; but the copper matt must, after some preliminary roastings, be first submitted to a concentration smelting in cupola furnaces, and then re-smelted in reverberatory furnaces with an addition of quartz, heavy spar, and coal, so as to prevent the formation of black copper. The coal added serves to reduce the sulphate of baryta to sulphide of barium, which reacts upon the oxide of copper present, forming sulphide of copper and oxide of barium, and the latter then becomes scorified by the quartz together with the oxide of iron. The expense is nearly the same whether treating copper matt or black copper, but the extraction of iron may be effected with greater security from black copper, and the manipulations for extracting silver are less troublesome.

The treatment of copper matt is based upon the facts that oxide of copper is readily dissolved by dilute sulphuric

acid, and oxide of iron, after being heated, with difficulty, and that antimonates and noble metals (silver) are very little dissolved, whilst gold is insoluble; the noble metals therefore remain in the residues, while sulphate of copper is produced. The residues are either fused with lead for the extraction of the precious metals, as at Freiberg, or they are extracted at once in the wet way, as at Schmöllnitz.

The copper matt of Freiberg resulting from the lead processes, and containing from 38 to 44 per cent of copper, is melted and concentrated in cupola furnaces. The resulting matt, containing 58 per cent of copper, is then smelted in reverberatory furnaces with an addition of quartz, heavy spar, and coal, and concentrated still further, so that after smelting it contains about 70 per cent of copper; the iron present is thus reduced to 0.3 per cent.

The matt is then pounded and sifted and roasted in double roasting furnaces for about 12 hours, in charges of 10 cwts., and after this first roasting it is ground and again roasted for 4 hours.

The tubs in which the roasted matt is treated with sulphuric acid are cylindrical,  $2\frac{3}{8}$  feet in diameter,  $3\frac{1}{2}$  feet high, and made of lead plates  $\frac{1}{2}$  inch thick. They are furnished with three iron hoops and three iron bars to keep them firm, and both hoops and bars are coated with lead. As the bottoms suffer a great deal by the deposition of crusts, they are cast from hard lead, and protected with a board. The tubs are provided with two openings, one two inches distant from the bottom for carrying off the residues, and a second four inches higher for tapping off the liquid; both openings are provided with short tubes, so that a gutta-percha pipe with cocks for closing may be joined to them. Each tub is provided with a leaden sieve resting upon strong leaden supports, and a movable leaden tube two inches wide, which reaches down to within one inch of the bottom. These tubes are connected with the main pipe for conducting the steam from the boiler by means of a caoutchouc tube; the steam is superheated in an apparatus above the tube.

Each tub receives 3 cubic feet of the liquid used for the previous process, and 3 cubic feet of impure sulphuric acid



of 45° or 47° B., and steam is admitted to the mixture, which now registers 34° or 36° B., while 2 cwts. of roasting mass are gradually stirred into it. After a quarter of an hour, 9 cubic feet of the liquid of the previous process are added, and the stirring is kept up continually for the first hour; it is afterwards carried on only every half-hour, and steam is admitted all the time to keep the mass up to the boiling point. After four or five hours the steam is withdrawn, and the mass is allowed to settle for half an hour; the liquid is next tapped off, and then the residues are washed with water, and the water added to the liquid. The residues contain from 3 to 5 per cent of copper, and a variable amount of silver; they are dried and worked up in the lead smelting process.

The liquid of 40° or 42° B., after having remained in the clarifying vessels, and there deposited basic iron salts, is conducted into the vessels for crystallisation. The crystals are deposited on strips of lead in about six days, and the resulting crystals are pounded and dissolved in liquid of 22° or 24° B., and re-crystallised in leaden vessels.

The acid liquid is used for extraction purposes three or four times more, then concentrated by boiling, and twice crystallised.

The annual production of sulphate of copper in Freiberg amounts to about 800 tons.

The following tables afford a comparison of the results of the extraction with sulphuric acid, and the results of Augustin's process, given on page 373.

At Freiberg, in the last six months of the year 1861, were worked up—

*a.* By roasting—

1151·2 cwts. of copper matt, containing—  
0·4175 per cent of silver and 71·20 per cent of copper.

Consuming for every cwt. of matt—

1·23 cwts. of slate coal.

Costing—

11·6d. for fuel. 7·3d. for labour.

*b.* The cost of grinding 1 cwt. of matt amounted to—

1·3d. for labour. 2·6d. for repairs.

*c.* Lixiviation.—From 1·17 to 2·03 cwts. of sulphuric acid were used for every cwt. of matt, and the cost for lixiviating 1 cwt. of matt amounted to 12s. 5·7d.

There were lost—

5 per cent of silver.                      4 per cent of copper.

And the total profit amounted to—

70 cwts. 56 lbs. of lead, or 15·9 per cent in money.

The working of 1 cwt. of copper matt gave a profit of—

15s. 10d.

In the first six months of the year 1862, there were treated—

8·59 cwts. of ores, flux ores, and dross, containing 8·205 lbs. of silver.

1,100 cubic feet solution for lixiviating, containing 5 lbs. of copper.

359 cwts. of copper matt from the roasting and lixiviating, containing 0·39 per cent of silver and 69 per cent of copper, and

1716·3 cwts. of copper matt, containing 40 per cent of silver and 70 per cent of copper.

Altogether there were obtained 826·53 lbs. of silver.

2330·72 cwts. of sulphuric acid of 66° B. were used.

The yield consisted of—*a.* In mercantile products—

4925·51 cwts. of sulphate of copper, containing per cwt. 25·4 lbs. of copper, worth £1 7s. 6d. per cwt.

16·85 cwts. of sulphate of iron, worth 4s. per cwt.

*b.* In residues—

456 cwts. containing 1·32 to 2·29 per cent of silver, 30 per cent of lead, and 7 to 18 per cent of copper,

Making altogether, 798·51 lbs. of silver.

The loss of silver therefore amounted to—

4·47 per cent.

**The Extraction of Silver from Black Copper**, which was formerly effected at the lower Hartz by the liquation process, is now done by sulphuric acid, and the result is a profit of about 11s. per cwt. of copper, whilst the former treatment gave a loss of about the same amount. The yield of silver, which is now about 87·7 to 90 per cent, was formerly only 70 per cent, and the present yield of gold is 30 times as large.

The process requires the following operations :—

*a.* **Dissolving the Copper.**—This is effected in wooden tubs coated with lead, 5 feet high, and 2½ and 3½ feet in diameter respectively at the top and bottom; they are furnished with 2 bottoms, the upper one being placed 5 inches

above the lower one. About  $1\frac{1}{4}$  tons of granulated copper is put into them, and then dilute sulphuric acid of 28°B., and heated to 70° C., is added. The solution of sulphate of copper is removed, as soon as formed, by a syphon, and every quarter of an hour fresh acid and fresh copper are added as required.

*b.* **Crystallisation of the Raw Vitriol.**—The solution is conducted for this purpose along a gutter 160 feet long, and the crystals formed are removed every three days and re-crystallised. The remaining acid liquid is used for diluting the sulphuric acid.

The argentiferous and auriferous slime which remains when the copper is dissolved partly adheres to the granulated copper, and is partly carried away with the solution into the crystallisation gutter, and becomes enclosed in the crystals, from which it is separated when they are dissolved for re-crystallisation.

The vitriol of Oker, in the Lower Hartz, is nearly chemically pure, and the composition of the small crystals (*b*) differs very little from that of the large ones (*a*), as the following analyses by Werlisch will show:—

	<i>a.</i>	<i>b.</i>
CuO . . . . .	30·595	31·881
SO <sub>3</sub> . . . . .	34·335	34·311
HO . . . . .	35·727	35·868
Zn and Fe . . . . .	trace	trace

Oker produced 7648·44 cwts. of vitriol in 1863.

*c.* **Fusion of the Residues with Lead.**—The slime, in the form of a leaden-grey mass, is repeatedly washed with water, and contains, besides silver and gold, sulphates, antimonates, and arseniates of lead and lime. An analysis by Ulrich proves it to have the following composition:—

Ag . . . . .	3·068	per cent.
Cu . . . . .	7·400	„
Pb . . . . .	23·100	„
CaO . . . . .	8·300	„
SO <sub>3</sub> . . . . .	16·200	„
Sb and As . . . . .	27·000	„

The large amount of antimony and arsenic present is derived from the impure sulphuric acid.

The residues are then moistened and mixed with pounded litharge, in the proportion of 2 : 1, and formed into balls; when dried they are smelted with such an addition of litharge and slags that a raw lead results, containing about  $1\frac{1}{4}$  per cent of silver; this raw lead is cupelled in the usual manner.

## CHAPTER III.

### ZINC.

#### PRINCIPAL ORES OF ZINC.

The following minerals are chiefly employed for the production of zinc, and may be considered as the principal zinc ores:—

1. **Calamine.**—This general name is given to the combinations of oxide of zinc with carbonic acid and silica.

**Carbonate of Zinc**, called by the special names, lamellar calamine, and noble calamine,  $ZnO, CO_2$ , is composed when pure of 65·20 per cent of  $ZnO$ , and contains 52 per cent of  $Zn$  and 34·80 per cent of  $CO_2$ . But part of the oxide of zinc is usually replaced by other metallic oxides and earths,\* such as oxide of iron, manganese, copper, cadmium, lead, calcium, and magnesium, from which circumstance this ore frequently contains only 40 per cent of zinc, or even less.

This carbonate of zinc† is seldom found in veins, and generally occurs in beds, nests, and impregnations in the *Devonian formation*; between *limestone* and *slate*, for instance, at Altenberg, near Aix-la-Chapelle, at Welkenrath, Stolberg, Corphalie, Engis, Brilon, and Iserlohn; in the

\* Analysen: Rammelsberg, *Handbuch der Mineral Chemie*, 1860, p. 1016. MUSPRATT—STROHMANN'S *Techn. Chem.* iii., 1851.

† v. DECHEN, *Statis. d. Zollv. Deutchl.* i., 760. *Berggiest*, 1858, p. 99; 1860, Nos. 54, 81; v. COTTA, *Erzlagerst.*, i., 94; ii., 133, 135, 182, 237, 341. *Ztschr. d. deutch geol. Gesellsch.*, 1857, p. 354. *B. u. h. Ztg.*, 1861, pp. 221, 263, 439; 1862, p. 264; 1860, p. 495. *Bgwkd.* xvi., 306. *KARST. Arch.*, 1 R., xvi., 424.

*magnesian limestone* at Hüggel, near Osnabrück; in *shell limestone* at Wiesloch, in Baden, in Upper Silesia, in Carinthia; in *Dolomite*, in Pennsylvania; and in *chalk* at Santander,\* in Spain; it also occurs in considerable deposits in Somersetshire, Derbyshire, and Cumberland.

This variety of calamine is frequently associated with other zinc minerals, and with iron spar, brown and yellow iron ore, galena, white lead ore, copper pyrites, &c., which render the extraction of zinc more difficult; they also require more complicated dressing operations, and the zinc is less pure. The dressing operations are simple when treating the purer sorts of calamine, which are only associated with clay and lime, and consist chiefly in the separation by hand of the larger pieces of ore; only the small ore (mine waste) is submitted to washing. This small ore is more impure than the large pieces, and the red calamine is richer in iron and magnesia than the grey and white calamine.† The difficulties in the treatment of calamine are increased the more iron it contains, owing to the formation of silicate of iron, which causes scorification, and destroys the distilling vessels. Some sorts of calamine, for instance, those of Wiesloch, contain upwards of 2 per cent of cadmium; many kinds are free from arsenic, copper, &c., and yield an excellent zinc.

**Hydrated Silicate of Zinc,** †  $3\text{ZnO}, \text{SiO}_3 + 2\text{HO}$ , with 52·5 per cent of zinc,  $2(3\text{ZnO}, \text{SiO}_3) + 3\text{HO}$ , with 53·7 per cent, and sometimes with a small amount of oxide of lead; when in an anhydrous state it is called Willemite,  $3\text{ZnO}, \text{SiO}_3$ , with 58·1 per cent of zinc, frequently containing a small quantity of  $\text{Mn}_2\text{O}_3$ ,  $\text{Fe}_2\text{O}_3$ ,  $\text{CaO}$ , and  $\text{MgO}$ .

**2. Hydrated Carbonate of Zinc** ( $\text{ZnO}, \text{CO}_2$ ) +  $2\text{ZnO}, \text{HO}$ , with 57·1 per cent of zinc, is found in extensive homogeneous masses associated with calamine at Cumillas, near Santander,|| in Spain, whence it is exported to Belgium, where it is worked in different smelting works.

\* v. COTTA, Erzlagerst. ii., 441. Berggeist, 1861, p. 484. B. u. h. Ztg., 1859, p. 223; 1861, pp. 112, 331.

† Ibid., 1860, pp. 38, 496.

‡ Ibid., 1861, p. 267.

|| Ann. d. Chem. u. Pharm. Bd. 108, p. 48.

3. **Red Zinc Ore.**— $ZnO$ , with 80·2 per cent of Zn. It is usually mixed with more or less  $Mn_2O_3$ , for instance, 88  $ZnO$  and 12  $Mn_2O_3$ . According to Rammelsberg, *Franklinite*\* probably consisting of 4  $Mn_2O_3$ , 8  $Fe_2O_3$ , 21  $FeO$ , and 15  $ZnO$ , occurs in New Jersey, U.S. It is used at Newark for the production of zinc oxide† and metallic zinc;‡ it contains some arsenic.

4. **Zinc Blende.**— $ZnS$ , with 66·9 per cent of zinc, sometimes containing  $FeS$ ,  $CdS$ , and small quantities of  $PbS$  and  $Sb_2S_3$ ; the black blende contains so much  $FeS$  that it may be considered as a combination of  $3ZnS + FeS$ , containing 51·6 Zn. According to Malaguti and Durocher,|| most blendes contain a small amount of silver up to 0·88 per cent, which cannot originate from the disseminated galena. In some cases the silver may be extracted from the residue of the blende by roasting (Przibram,§ Llansamlet, near Swansea),¶ &c. If galena and zinc blende occur together, the former usually contains most silver.\*\* Zinc has a greater affinity for silver than lead, the exception being the blende at Poullaouen, which contains twenty times as much silver as the associated galena. Blende sometimes contains a small amount of gold; a radiated variety found at Przibram is remarkable for containing a large proportion of cadmium.

The zinc ores of England,†† like those of France, Belgium, and Silesia, occur in two geological localities.

The first locality is in the *carboniferous or mountain limestone*, where it occurs in veins; blende and calamine usually accompany the numerous veins of galena, which traverse the limestone, though there are many lead mines that yield no calamine; and, on the other hand, there are veins of calamine alone, as at Matlock, from which a considerable quantity of this ore is obtained.

\* TUNNER, *Löben. Jahrb.* 1852, p. 43. *Bgwkfd.* xvii., 629. *B. u. h. Ztg.*, 1847, p. 489; 1855, p. 83. *Berggeist*, 1858, p. 98.

† *B. u. h. Ztg.*, 1855, p. 83.

‡ *B. u. h. Ztg.*, 1861, pp. 199, 221.

|| *B. u. h. Ztg.*, 1851, No. 1.

§ *LEOBEN. Jahrb.*, 1857, vii., 239, 250, 256.

¶ PERCY, *Metallurgy* i., 569.

\*\* KARST, *Archiv.*, 2 R., xxv., 190.

†† DR. URE, *Dictionary of Arts, &c.*, vol. iii., 1122.

Lead and zinc ores are searched for in almost every part of England where metalliferous limestone appears; the neighbourhood of Alston-Moor, in Cumberland, of Castleton and Matlock, in Derbyshire, and the small metalliferous belt of Flintshire, are remarkable for their mineral riches. On the north of Flintshire, calamine is found in a rich mine of galena at Holywell, where it presents the singular appearance of occurring only in the ramifications of lead veins from east to west, and never in those from north to south; while the blende, which is abundant in this mine, is found indifferently in all directions.

The second locality of calamine is *the magnesian limestone formation* of the English geologists (the *Alpine limestone* of the French, and the *zechstein* of the Germans). The calamine is disseminated through it in small contemporaneous veins, which run in all directions, like network. These veins are usually only a few inches thick, but in certain cases they extend to 4 feet, in consequence of the union of several small ones into a single mass; calamine was formerly sought for in the magnesian limestone situated chiefly on the flanks of the Mendip Hills, a chain running from north-west to south-east, from the Bristol channel to Frome. Calamine was chiefly worked in the neighbourhood of Phipham and Roborough, also near Rickford and Broadfield-Doron, by means of a number of small shafts. The miners paid the Lords of the Treasury a tax of £1 per annum for the privilege of working, and they mixed the ores with a considerable quantity of carbonate of lime, washing them slightly in a sieve, and sold them at Phipham. Very little is worked in this district at present. Calamine is now largely imported into this country from Spain, and the United States of America.

#### SYNOPSIS OF PROCESSES FOR THE EXTRACTION OF ZINC FROM ITS ORES.

The different methods of extracting zinc from the ores are based upon certain preliminary operations of calcining and roasting, thus forming oxide of zinc, which may then



be reduced. As the reduction of the oxide of zinc takes place only at a temperature of about  $1,300^{\circ}\text{C}$ ., while zinc volatilises at  $1,200^{\circ}\text{C}$ ., its extraction in a liquid state is only possible by a process of distillation, and condensing the zinc vapours. The condensation must be effected at  $800^{\circ}\text{C}$ ., or lower, in order to avoid the escape of zinc vapour with the gases which are formed by the reduction. These gases, carbonic oxide, and carbonic acid, are always associated with zinc vapour, and they, as well as the steam and atmospheric air present, partially oxidise the zinc, unless they are cooled below a certain temperature. In order to prevent the oxidation of the zinc vapour as far as possible, the ores to be treated must be previously freed from carbonic acid and water by calcination, and after its formation the zinc vapour must be conducted as quickly as possible into strongly cooled condensers, which should not be too spacious, or the air contained in them will oxidise much zinc. If the zinc vapour, for the purpose of excluding atmospheric air, were conducted into condensers sealed by water, like the gas-holders of coal gas, it would permeate the distilling vessels owing to its pressure, and the reduction would be impeded.

As carbonic acid is invariably formed in the reduction of the oxide of zinc by means of coal, and as the condensers always contain atmospheric air, the formation of a small quantity of oxide of zinc cannot be avoided.

According to Müller,\* the amount of oxide of zinc formed by carbonic acid depends chiefly on the temperature at which the reduction is conducted. Müller states:—

1. That carbonic acid is transformed into carbonic oxide at a lower temperature than is required for condensing the zinc gases;
2. That zinc distils at an incipient white heat;
3. That carbonic oxide gas reduces oxide of zinc at a temperature slightly higher than that at which the distillation of the zinc commences, forming zinc vapour and carbonic acid. The carbonic acid has an oxidising action upon the zinc as soon as the carbonic oxide gas ceases to reduce it,

\* A. MÜLLER, *Metallurgie du Zinc*, Paris, 1862, p. 6. B. u. h. Ztg., 1862, p. 324.

if the zinc vapour is not quickly conducted into a very cool condenser.

4. That coal will only reduce oxide of zinc at a much higher temperature than carbonic oxide gas.

From these facts regarding the formation of oxide of zinc, the following conclusions may be drawn :—

*a.* If zinc vapour, coal, and carbonic acid come into contact at a moderate temperature, the carbonic acid will oxidise the zinc and coal.

*b.* If the temperature be lower than that required for reducing oxide of zinc by coal, oxide of zinc will be formed, thus :—

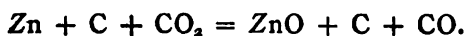

*c.* If the temperature is sufficiently high to allow the reduction of oxide of zinc by means of coal, or even higher, the zinc will be only slightly oxidised, and carbonic oxide gas be chiefly formed :—



*d.* If water be present the result of the reaction will be  $\text{Zn} + \text{HO} + \text{C}$ , at a lower temperature  $\text{ZnO} + \text{C} + \text{H}$ , and at a higher temperature,  $\text{Zn} + \text{CO} + \text{H}$ .

The experiments of Percy,\* Berthier, and others have proved that metallic zinc may be extracted directly from zinc blende by heating the zinc blende, with other metals† and metallic oxides, with coal, lime, alkalies, &c., but mostly with those requiring very high temperatures ; the distilling vessels are much wasted, and the production is proportionally small, while the expense is increased by the reagents employed.

All the modes of extracting zinc are based upon these chemical principles, and only differ in the form of the distilling vessels, which depends on circumstances, chiefly the price of clay, and fuel ; the following objections are common to the different modes :—The formation of oxide of zinc, the loss of zinc by volatilisation, the imperfect use of the fuel, the necessity for expensive distilling vessels, the interruption of the process, the waste of fuel and time, &c.

\* PERCY, Metallurgy, 1861, i., 541.

† B. u. h. Ztg., 1861, p. 292. Polyt. Centr., 1861, No. 21.

Different experiments in the employment of cupola furnaces have been tried in order to obviate these disadvantages, but the results were unsatisfactory, as the noxious influence of the carbonic acid, formed by the reduction of the oxide of zinc, upon the zinc vapour cannot be avoided, in consequence of which more oxide of zinc is usually produced than metallic zinc.

These experiments have therefore at present been confined to improvements in the distilling process by constructions aiming at a saving of fuel, and at a more perfect extraction of the zinc; in many places they have been attended with success.

An improvement\* in the distillation process has lately been tried by separating the process into two divisions,—first, the production of oxide of zinc, and then its reduction in the usual manner.

As carried on at the present time, the process is expensive, and requires ores containing a certain amount of zinc, in order to be profitable. As that amount can seldom be raised high enough by dressing the ores, &c., to allow a large production in a proportionately short time, the cost of labour, fuel, and clay vessels is very high. At Upper Silesia, for instance, it amounts to 15s. per day per furnace, whether the furnace produces 1 cwt. of zinc or more. The poorest ores are therefore treated in a blast cupola furnace without being dressed, producing a rich intermediate product by condensing the volatilised zinc, either as such or as oxide; this may then be worked up more carefully, thus causing less expense and loss of metal. The following approximate calculation is in favour of the preceding method:—

The calamine treated in the smelting works of Upper Silesia, contains 15 per cent of zinc on an average, and causes in its extraction a loss of 7 per cent; 1 furnace is daily charged with 15 cwts., and therefore 180 furnaces would treat 135 tons of calamine. If this quantity were treated in a cupola furnace for the production of 27 tons of rich intermediate product, costing £15, its reduction would

\* Schles. Wochenschr, 1860, No. 17. B. u. h. Ztg., 1861, p. 352.

only require 36 furnaces, thus saving 144 furnaces, or 144 times 15s., daily; the cost of dressing the ores would also be saved, and the poorest ores, which are excluded in the usual treatment, could be used.

Duclos de Bussois\* formerly recommended this method.

The residues of washing calamine have been treated in the wet way for the production of oxide and chloride of zinc.†

The methods of extracting zinc now in general use, comprise the following manipulations:—

### I. PREPARATION OF THE ORES.

- a. Calcining the calamine, and roasting the zinc blende.
- b. Pounding the ores.
- c. Mixing the same.

### II. DISTILLATION OF THE ZINC.

- a. Belgian methods of distilling in slightly inclined retorts.
- b. Silesian method of distilling in muffles.
- c. English method of distilling in crucibles.
- d. Carinthian method of distilling in vertical retorts.

### III. FURTHER TREATMENT OF THE PRODUCTS.

- a. Re-melting and refining the raw zinc.
- b. Reduction of the zinc dust.
- c. Treatment of the residues and deposits in the distilling vessels.

#### I. PREPARATION OF ZINC ORES.

##### a. Calcining and Roasting Zinc Ores.

The calamine is calcined for the purpose of rendering the ore less compact, so that the reduction of the oxide of zinc by means of carbonic oxide gas takes place more easily; and also to expel water and carbonic acid, which, if present in the distillation of zinc, would oxidise the metal, render some heat latent, and carry away particles of ore. The loss by calcination usually amounts to 25 or 30 per cent, and in some cases to 50 per cent.

\* Bgwkd., vi., 377.

† B. u. h. Ztg., 1862, p. 305.

The following are the methods of calcination now in use :—

**Calcination in Cupola Furnaces**, is chiefly used for ore in large pieces, and may be effected by charging the calamine intermixed with layers of fuel. In this manner the fuel is most economised, but if the temperature rises too high, a reduction and volatilisation of zinc will take place, and the ore becomes somewhat contaminated by the ash of the fuel.

This method is most frequently employed, as it permits of a large production ; thus, at Altenberg, in 24 hours, one furnace roasts 25 tons of raw calamine, causing a loss of about 27 per cent.

Besides these furnaces in the form of ordinary kilns, some are used having one or more fire-grates, and which are heated by the flame produced on the fire-grates. Such a furnace with one fire-grate is frequently used in Southern Spain ; it

FIG. 107.

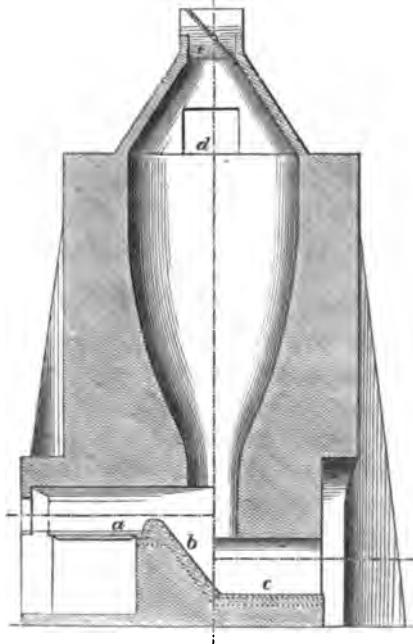
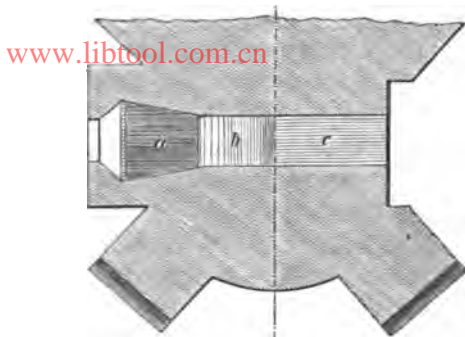

FIG. 108.



is represented by Figs. 107 and 108. *a*, is the grate; *b*, the inclined plane for the ore to glide down on; *c*, opening for removing the ore; *d*, the opening for charging the ore; *e*, the opening for letting the gas escape. This furnace yields from 5 to 8 tons of calcined calamine in 24 hours, whilst a furnace with two fire-places yields as much as 10 tons, consuming 8 or 9 per cent of coal; the ore loses 33 per cent of its weight. The furnace is attended to by six workmen. Though not possessing all the disadvantages of the former mode of calcining, this method is more apt to yield a less uniformly calcined product.

**Calcination in Reverberatory Furnaces** only permits a smaller production than that of the cupola furnaces, and is chiefly employed for small ore; larger pieces of ore are difficult to turn, and do not calcine uniformly throughout.

The reverberatory furnaces in use are either heated by direct fuel or by the gases of the distilling furnaces.

Furnaces with direct firing and furnished with two hearths are used at Moresnet and at Welkenrath, near Aix-la-Chapelle; on an average, one of these furnaces calcines 8 tons of calamine in 24 hours, consuming about 27 cubic feet of coal.

Furnaces heated by the gases of the distilling furnaces effect a considerable saving of fuel, but in some cases they influence the draught and the temperature of the distilling furnace, and are apt to cool the distilling vessels lying next to the calcining furnace; freshly charged calamine, which

is sometimes wet, will cool the distilling vessels, being separated from them only by a small partition wall, and so injure their yield; newer furnaces for calcining are, therefore, erected at a sufficient distance from the distilling furnace to make a cooling influence impossible.

In Belgium two calcining furnaces are laid side by side above the uppermost tier of retorts; one of these furnaces calcines 2 tons in 24 hours.

At Moriston, near Swansea, four distilling furnaces are always built one beside another, in order to render the escaping flame more effectual for calcining purposes.

**The Roasting of Zinc Blende** aims at the transformation of the sulphide into oxide of zinc; this is not effected without difficulty, as the sulphate of zinc which is formed at the same time only becomes decomposed at a strong red heat, forming oxide of zinc, sulphurous acid, and oxygen, besides a little sulphuric acid; and as the compactness of the blende prevents its being permeated by oxygen, a core of raw blende always remains in the larger pieces.

Though some sorts of blende if once kindled continue to roast, they still yield, when roasted in cupola furnaces and in larger pieces, a product too rich in sulphur, for the reason before stated. Cupola furnaces are not, therefore, used for roasting blende, but sometimes, as in Corphalie,\* for rendering the blende so friable, that it may be easily reduced to powder.

Blende can only be well roasted if reduced to a uniform powder, the average size of the grains being 2 lines. The roasting must be effected in reverberatory furnaces, and must be long continued. If the escaping sulphurous acid is to be used for the sulphurisation of copper ores, or for the production of sulphuric acid, the roasting is performed in a sort of muffle furnace; some kinds of blende decrepitate when heated, and thus facilitate the roasting; but even in well-roasted blende which has seldom lost more than 15 or 16 per cent by roasting, 1 or 1½ per cent of sulphur is usually left, chiefly as sulphate; this can only be expelled at a

\* Ann. d. min., 1 livr. de 1844, pp. 202, 269. Bgwkd. x., 270, 282.

very high temperature, causing a great consumption of fuel, and it cannot be lixiviated by water owing to its basic nature. The lower the temperature of roasting the more sulphate will be formed.

The roasting of blende is much more expensive than the calcining of calamine. At the smelting works at Borbeck and Oberhausen the consumption of coal, per 100 lbs. of zinc produced from blende, amounts to 128 lbs. merely for roasting the latter, and only to 13 or 15 lbs. of coal for calcining a quantity of calamine sufficient for the production of 100 lbs. of zinc. 100 lbs. of roasted blende, yielding 36 per cent of zinc, consume 45 lbs. of coal, costing about 7d., including 1·4d. for pulverising the blende.

Calamine and blende are of the same value for the purpose of extracting their zinc, if the price of blende is as much lower than that of calamine, as the roasting of blende is more expensive than the calcining of calamine. In order to compare the metal which both ores yield, the zinc, which is retained by the sulphur (*i.e.*, one equivalent of zinc for every equivalent of sulphur) must be deducted from the zinc contained in blende; foreign impurities may also have a considerable influence upon the value of blende, so much so, indeed, that a poor blende is sometimes more valuable than a rich one.

Foreign impurities are more frequently contained in blende than in calamine; they not only alloy the zinc, as, for instance, cadmium, antimony, arsenic, lead, copper, &c., and cause a rapid waste of the distilling vessels, but they also injure and modify the roasting process.

Sulphides of lead, antimony, and copper are apt to cause a caking of the roasting mass; on this account they necessitate a low temperature from the beginning, and thus cause the formation of much sulphate.

Iron pyrites, though of use in the roasting process, also facilitates the formation of sulphate of zinc, and, if silica be present, gives rise to the formation of easily fusible silicates of iron. The oxide of iron formed, as well as the undecomposed sulphide of iron, then attack the distilling vessels. Black ferruginous blende behaves in the same manner. The dis-



tilling muffles at Steinfurt,\* near Stolberg, have been glazed in order to prevent the corrosive action of the silicates of iron.

Quartzose blende must be roasted throughout the process at rather a high temperature, in order to prevent the formation of much sulphate of zinc; therefore the temperature need not be raised at the end of the process, or it would otherwise cause a scorification of foreign oxides. Oxide of zinc forms with silica a silicate which also cakes only at white heat,† and which gelatinises when treated with acids.

Roasted blende containing oxide of iron is very difficult to dissolve in acids, but according to Ramdohr, it becomes easily soluble by adding a piece of zinc or iron, thus reducing the almost insoluble peroxide into protoxide.

Calcareous and aluminous blendes must be submitted to a high temperature from the beginning of the process, as they are apt to retain sulphuric acid which has been formed by the roasting.

When roasting argentiferous blende the loss of silver increases *pari passu* with the increase of the temperature. According to Malaguti, Durocher, and Plattner this loss may amount to 70 per cent, and it is most considerable towards the end of the process, after much sulphate of zinc has been formed. These ores are therefore carefully roasted in a very finely divided state in common reverberatory furnaces provided with condensation chambers, as at Swansea, or at Przibram in muffle furnaces, where the escaping sulphurous acid is used for the production of sulphuric acid. According to Malaguti and Durocher,‡ zinc resulting from distilling argentiferous roasted blende contains only traces of silver, which deposits on the sides of the retort, &c., in the form of small globules.

As before mentioned, the roasting process is chiefly performed in reverberatory furnaces, with two hearths, one lying above the other; furnaces with one hearth are seldom used.

\* B. u. h. Ztg., 1860, p. 92.

† PERCY, Metallurgy, 1861, i., p. 536.

‡ B. u. h. Ztg., 1851, No. 1.

In order to have a perfect control over the process, it is preferable to use direct firing instead of the gases escaping from the distilling vessels.

The furnaces with two hearths allow the most perfect roasting, as the ores are first exposed on the upper hearth to a gradually rising temperature, and when prepared are removed to the lower hearth for complete desulphurisation, after which they are able to stand the higher temperature without caking.

At Borbeck\* from 18 to 20 cwts. are roasted in these double furnaces, first on the upper hearth for 12 hours, and afterwards for the same time on the lower hearth, the mass being stirred with a rake every 20 minutes. The loss amounts to 16 per cent, and five tons of roasted ore consume about 70 cubic feet of coal.

At Llansamlet,† near Swansea, argentiferous blende is roasted after being ground and passed through a sieve with 225 holes to the square inch. The furnaces are double furnaces, the upper hearth being 15 feet long, 9 feet broad, and lying 5 feet above the lower hearth, which is 9 feet broad and 12 feet long; the fire-bridge is 2 feet 4 inches high. The middle of the arched roof is 3 feet 4 inches above the lower hearth and 1 foot at the end, and is provided with two openings, each 6 inches square, and with two funnels on the top, each capable of containing half a ton of blende. A charge of 1 ton is roasted on the upper hearth for 11 hours, the roasting mass being stirred every ten minutes; and afterwards for the same length of time on the lower hearth, until no more sulphurous acid escapes.

The very carefully roasted ore is then desilverised, and only the residue used for the extraction of zinc. The raw blende containing 37 per cent of zinc yields a roasting mass containing 43·4 per cent, wherefore the loss of zinc amounts to 2 per cent,  $\frac{1}{2}$  per cent of which is regained from the condensed smoke.

Furnaces with a hearth in the form of terraces, are used

\* B. u. h. Ztg., 1859, p. 425; 1860, p. 99.

† ПЕРСВ, Metallurgy, i., 567.

at Moriston, near Swansea; this apparatus\* consists of a reverberatory furnace, about 36 feet long and 9 feet wide, provided with a fire-place of the usual construction. The sole or hearth of this apparatus is divided into three distinct beds, the one nearest the fire-bridge is four inches lower than its neighbour, which again is four inches lower than that nearest the chimney. In addition to the heat derived from the fire-place the gases escaping from the reducing furnaces are usually introduced before the bridge.

When the furnace has been sufficiently heated a charge of 12 cwts. of raw blende is introduced into the division nearest the chimney, spread equally over the bottom, and carefully stirred from time to time by an iron rake. After about eight hours, this charge is worked on to the floor of the compartment forming the middle of the furnace, and a new charge is introduced into the division next the chimney. About eight hours after this charging, the ore on the middle bed is worked on to the first, whilst that on the hearth next the chimney is spread equally on the middle one, and a new charge introduced into the division next the stack. After another eight hours the charge on the first hearth is drawn, the ore on the middle and third hearths moved forward, and a fourth charge introduced as before. Thus the operation is continuous, and each furnace will effect the calcination of about  $1\frac{1}{4}$  tons of ordinary blende in the course of 24 hours.

Although the roasting of blende in muffle furnaces causes a greater consumption of fuel, it is done for the purpose of utilising the escaping sulphurous acid, care having been taken that it does not come in contact with the gases of the firing. As blende is difficult to oxidise, on account of its compactness, the roasting is sometimes effected by means of blast or hot air † (Crockford's method). As the sulphate of zinc does not become perfectly decomposed in muffle furnaces, owing to the want of a sufficiently high temperature, the resulting mass is either roasted again in a reverberatory

\* Dr. URE'S Dictionary of Arts, vol. p. 1123.

† B. u. h. Ztg., 1859, p. 176.

furnace at a higher temperature, or a muffle furnace is combined with a reverberatory furnace in such a manner that, after having heated the muffle, the gases of the firing pass to a hearth lying above it, and thence into the chimney. The blende is next roasted in the muffle to extract the sulphurous acid, but its roasting is completed on the hearth. When roasting argentiferous blende in order to form sulphate, the silver will be extracted by a roasting in a muffle furnace; sometimes, as in Przibram, two muffles are constructed one above the other, in order to utilise the heat escaping from the lower muffle.

At Przibram, argentiferous blende is roasted in double-muffle furnaces, the escaping sulphurous acid being used for the production of sulphuric acid in leaden chambers, and the sulphates formed for the extraction of silver. The furnaces employed are represented by Figs. 109, 110, 111, 112, and 113. *a* is the upper, and *b* the lower hearth. The

FIG. 109.

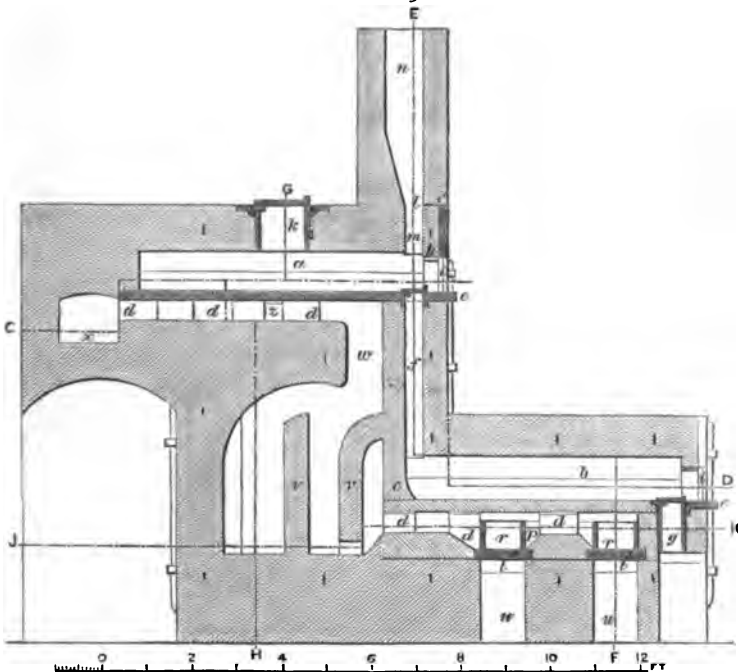

sole of the upper hearth consists of 9 cast-iron plates, which overlap each other by 1 inch; the lower hearth is formed of refractory bricks. The back part of the lower muffle forms a projection (*c*) to protect the hearth sole from the roasting mass when it is thrown down from the upper hearth by means of the channel (*f*). Both hearths are supported by bricks at *d*. The soles of the upper as well as the lower hearth are connected with the fore-hearth plates (*e*), both having openings for the respective channels (*f* and *g*), into which the case (*h*) for the working door is fitted. The working doors (*i*) of both hearths can be closed by a lid. The raw ore is charged by the channel *k* upon the upper hearth, and then drawn by the channel *f* on to the lower hearth,

FIG. 110.

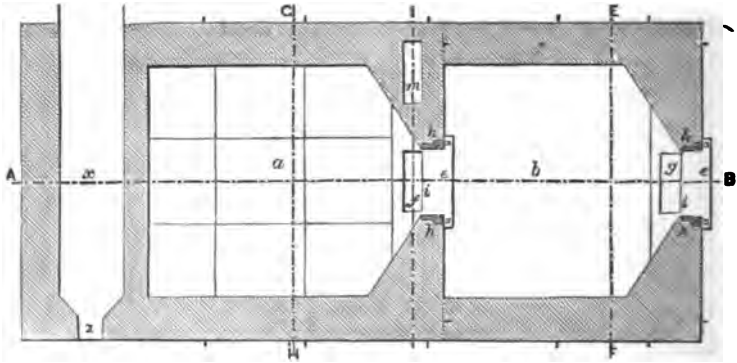

FIG. 111.

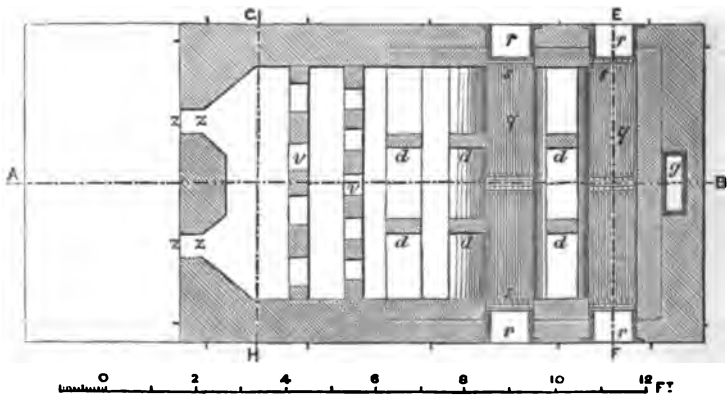

FIG. 112.

[www.libtool.com.cn](http://www.libtool.com.cn)

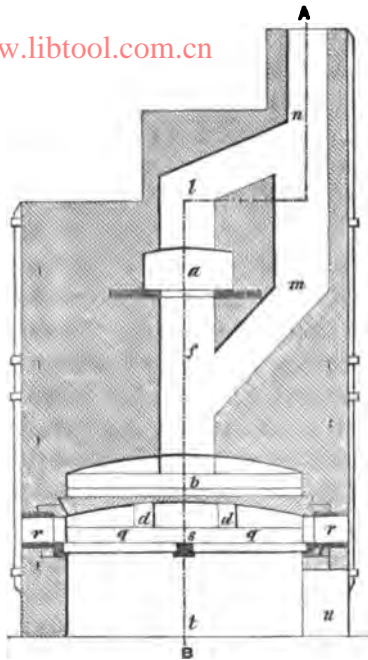
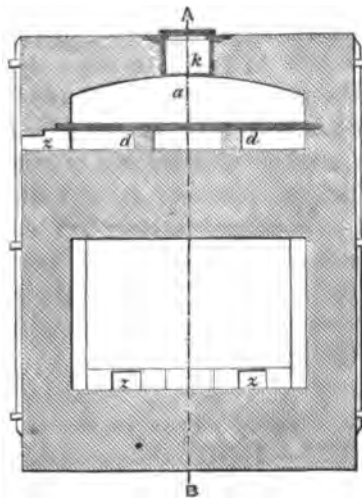

FIG. 113.



2 E 2

from which it is made, after roasting, to fall upon the floor of the smelting house by the channel *g*. The channel *l* serves for conducting moisture and any sulphurous acid which may have been formed on the upper hearth, and the channel *m* for conducting the gases produced by the roasting on the lower hearth, both communicating with the channel (*n*), and conducted by means of it either into the leaden chambers or into the open air. Both channels (*l* and *m*) are provided with sliding doors (*o*) for regulating the draught. The firing of the lower hearth is effected by the fire-place (*p*), which is provided with 4 grates (*q*), and may be closed by the doors (*r*). The grates rest on iron supports (*s*). Channels (*u*) provided with doors, partly for regulating the admission of air, and partly for allowing the removal of ash, lead into the ash-pits (*t, t*).

The upper hearth is heated by the gases formed on the lower grates, and the gases are made to pass between the two partition-walls (*v* and *v'*), partly to prevent their escaping too quickly, and partly to concentrate the heat; they then pass into the channel (*w*), from thence beneath the sole of the upper hearth, and escape by *x* into the chimney which is standing at the side. *x, x* are doors allowing the removal of flue-dust; charges of 6 or 7 cwts. are roasted in eight hours.

#### **b. Dividing the Calcined or Roasted Ores.**

The calcined calamine, before undergoing fine division, is often sorted by hand, in order to separate the ferruginous calamine from the purer kinds, and to remove the siliceous calamine which has been little modified by the fire.

The Silesian method of distilling requires ore of coarser grain than the Belgian process. Edge mills are chiefly used for crushing the calamine, as they are very effective, and require few repairs. Such a mill (at Moresnet, for instance), having 2 edge runners, 1'6 metres in diameter, and 0'35 metre broad, and weighing 3 tons 4 cwts., turns out from 15 to 18 tons of powdered calamine in the course of 12 hours.

At Angleur, the production is increased by coupling two mills together. The upper mill is like a common coffee mill; a truncated and fluted cone of cast-iron, 1½ feet in

diameter in the middle, is moved in a vertical direction in a suitably formed vessel; the ore ground in it falls upon a common edge mill, by means of a sifting hopper; this machinery requires about 10 or 12 horse power, and crushes from 40 to 50 tons of calamine in 12 hours.

As the roasted blende is powdered, either by rollers or by edge mills, previous to its roasting, it requires no further pulverising.

### c. Mixing the Zinc Ores.

Strongly basic zinc ores, containing much peroxide of iron and lime, must be mixed with siliceous and aluminous ores, partly to obtain a moderate amount of metal if the ores differ in richness, but chiefly to preserve the distilling vessels. Such ores, rich in oxide of iron, combine with the silica of the distilling vessels, thus forming holes and causing loss of zinc. The presence of lead in the ores is most injurious to the distilling vessels. The vessels suffer more from basic ores in the Silesian process than in the Belgian process, which takes less time.

In order to reduce the oxide of zinc, the ore is mixed with 45 or 46 per cent of non-caking coal, free from sulphur and slate, and some small coke; fuel and ore in equal weights are seldom employed. Either material employed separately does not yield so much zinc as a mixture of the two in equal parts. Coal has a stronger reducing action than coke alone, probably because the gases formed at the beginning permeate the ore, and deposit finely divided carbon; but the aqueous vapour formed at the same time, seems to assist the formation of zinc powder, which will be explained presently. The quantity of steam is lessened by a partial substitution of coal by coke; and the surplus of coal also renders the ore less compact. In some zinc works an addition of common salt is given, in order to expel the zinc more completely at a low temperature, and at the same time to glaze the vessels. Though siliceous calamine may be decomposed at a very high temperature by means of coal alone,\* the extraction of zinc must be assisted by an addition of from

\* PERCY, Metallurgy, i., 537, 596.



15 to 25 per cent of calcareous ores or lime; according to Schoonbroodt,\* this must also be done when distilling at a low temperature.

Zinciferous furnace deposits require more coal than calamine.

As the reduction of oxide of zinc is chiefly effected by carbonic oxide gas, an intimate mixing of the coal with the ore is not required, and it is better to employ the coal in pieces the size of nuts than in a powdered form, in order to facilitate the permeation of carbonic oxide gas.

In the Belgian process the ore is used in a finely divided state, in order to get as much as possible of it into the retorts, into which it is firmly pressed, after having been moistened to avoid dust. The ore treated by the Silesian process, on the contrary, is best used in pieces the size of a nut, as when the dry mixture is thrown into the muffles, the finely divided ore would separate from the coal, and, owing to its greater specific gravity, would mostly fall to the bottom of the muffle and so occasion a smaller yield of metal. If finely divided ore—blende for instance—is employed, the coal must be somewhat moistened to make the ore powder stick to it.

An addition of 4 or 5 per cent of common salt to the first 3 or 4 mixtures assists the glazing of the inside of the distilling vessels.†

## II. DISTILLATION OF ZINC.

If the ore mixture is heated to a sufficiently high temperature in a suitable distilling vessel, furnished with a receiver, zinc vapour will enter the receiver soon after charging the ore, whilst coal gases are rapidly evolved. At the beginning the temperature of the receiver is not sufficiently high to melt the zinc powder, and the temperature is intentionally kept low in the furnace; this low temperature causes the zinc vapour to form a pulverulent sublimate, part

\* ARMENGAUD'S *Genie Industriel*, Jan. 1860, p. 45. *DINGL. Polyt. Journ.*, Bd. 157, p. 61. TUNNER'S *Bericht. ü. d. Lond. Industrieausst.*, v. 1862. Wien, 1863, p. 21.

† *Bgwkd.*, ix., 562.

of which is carried away by the rapidly evolved coal gases, and part burns with a greenish white flame on coming into contact with the air at the mouth of the receiver, forming a yellowish white deposit on the nearest parts. This product consists of finely divided metallic zinc, oxide of zinc, and volatile substances, such as cadmium, antimony, arsenic, &c., and is collected in vessels standing before the receiver. It is afterwards worked up, but always yields a hard zinc, and for this reason its formation is limited as much as possible; nevertheless 9 or 10 per cent of the whole production will always result as impure zinc dust.

If the receiver has attained a higher temperature, two or three hours after the charging most of its zinc will be condensed in a liquid form, and the formation of zinc dust will decrease, though some will be formed up to the end of the process; this is indicated by little or no flame of zinc appearing at the mouth of the recipient, while the firing has been gradually increased. If the zinc flame disappears too soon, it is usually a sign that the distilling vessels have become defective; air will enter the cracks and will oxidise the reduced zinc.

While still liquid the zinc in the receivers is poured either into cast-iron moulds, or allowed to drop into reservoirs and solidify, in which case it must be re-melted in clay or iron pots. Impure zinc is thus refined.

A new charge is given after removing from the distilling vessels the residues, and any deposits which may have been formed.

The reduction of calamine, or of well-roasted blende, containing the same amount of zinc, takes place equally well; and sometimes the blende is more easily reduced than a siliceous calamine.

The different modes of distilling zinc, though all based upon the same theory, differ in the form of the distilling furnaces, and in the form of the vessels employed, as before mentioned.

The English and Carinthian methods are now rarely employed, and the experiments made to extract zinc in cupola and reverberatory furnaces have not been successful enough

to cause them to be adopted on a large scale, therefore the only choice is between the Belgian and Silesian methods.

The chief basis of the production of zinc from ores not too poor or expensive, as well as that of the choice between the different methods, depends on the prices of the fuel and clay. In the present state of zinc manufacture the production of zinc is, in Belgium for instance, only profitable if the price of a ton of coal does not exceed 11'9s., and of a ton of clay £1 7'7s.; and provided the ores contain 45 per cent of zinc.

The profit of zinc works is larger the less distance the ore, clay, and especially coal, have to be carried, as the consumption of these three materials amounts to about the following proportions—namely, 50 per cent of coal, 35 per cent of ore, and 15 per cent of clay; thus it is better to carry the ore to the coal.

When comparing the different methods of extracting zinc and choosing between them, the following are the points mostly to be taken into consideration:—

1. **The Price and Quality of the Coal.**—A good coal is required to produce the necessary high temperature; wood and turf are seldom employed, as they are too expensive. Experiments have been made in Silesia to use gas for fuel, but with no favourable result, as the fire-places waste too rapidly.

The consumption of coal is smallest in the Belgian furnaces, where the flame fully surrounds the retorts, while it does not touch the bottom of the muffles and crucibles employed in the other methods; the Carinthian method is the most unfavourable, as it does not allow a continued process.

For the production of 1 cwt. of raw zinc in Belgium, from 6 to 8 cwts. of bituminous coal are used; in Silesia, from 10 to 15 cwts., and even 1 ton of non-caking coal; and in the old English method, 1¼ tons of good coal.

Bituminous coal evolves a considerable amount of gas, which keeps the furnace at a certain pressure, and consequently a continuous strong heat is produced, admitting of a regular process. This coal also possesses the advantage of forming an ash or clinker grate. Non-caking coal only

yields much gas at the beginning, so that the furnace can only be raised periodically to a high temperature by charging large quantities of coal.

Efforts have been made to save fuel and to increase the production by enlarging the distilling vessels, or by increasing their number, but it was proved that when exceeding a certain limit, the loss of zinc increased as well as the consumption of clay, while the consumption of fuel decreased very little, or not at all, and more labour was required. The Belgian furnaces are therefore very little modified; but this has been the case with the Silesian furnaces, partly by conducting the flame below, and partly by employing 2 tiers of muffles, one above the other, thus effecting a considerable saving in fuel.

2. **The Price and Quality of the Clay.**—The quality of the clay, and the care and skill with which the refractory materials are manufactured, have an essential influence upon the results of the zinc works.\*

The most excellent clay for zinc works is that from Andenne,† in Belgium; it is used in the zinc works near Swansea, in preference to good English and Scotch clays.

The following is Coste's analysis of the Belgian clay:—

	Tabier.	Mazet.	Maizerul.	Haltinne.	Namur.
Silica . . . .	56·0	52·0	46·0	40·0	71·79
Alumina . . . .	26·0	25·0	33·4	25·0	19·49
Magnesia . . . .	2·0	trace	1·0	1·6	0·06
Peroxide of iron	—	—	—	0·4	0·85
Alkalies . . . .	—	—	—	—	0·85
Water . . . .	14·0	12·6	18·6	15·0	7·47
Sand . . . .	2·0	9·8	1·0	18·0	0·85

This clay is sold in the form of large, oblong lumps, usually dark coloured, and weighing from 40 to 50 lbs. each; on the Rhine it costs about £1 4s. per ton, free on board.

Fewer clay vessels are used for the Silesian method, but they are more difficult to manufacture, and require more time.

\* B. u. h. Ztg., 1861, pp. 335, 389, 408, 438.; 1862, pp. 18, 116, 240, 262, 327. Bergeist, 1861, No. 104; 1862, No. 48. DINGL., Bd. 159, p. 54; Bd. 161, pp. 208, 291; Bd. 163, p. 193; Bd. 164, p. 116.

† B. u. h. Ztg., 1862, p. 262.

The Belgian retorts are more apt to crack and to become crooked, as they are only supported on both ends, while the muffles rest upon their bottom. The expense for retorts calculated upon 1 cwt. of produced zinc, amount to 2s. 4·5d., and for muffles to 1s. 7d. As the clay vessels of the English crucible furnaces wear a long time, this method is retained in some few places where coal is very cheap, as for instance at Neath,\* near Swansea; a less refractory clay, which is not suitable for retorts, may still do for muffles. If retorts manufactured of such clay were employed, the lower retorts would be likely to melt if a temperature were produced sufficient to volatilise the zinc in the upper retorts.

**3. The Amount of Zinc in the Ores.**—Whether poor ores can be profitably treated for the extraction of their zinc will depend on the price of coal, clay, and labour; on this account ores containing less than 40 per cent of zinc cannot be worked with advantage in Belgium, while ores which only contain from 18 to 20 per cent are profitably worked in Silesia. The yield in muffles is larger than in retorts, as the residues are poorer, owing to the greater length of the process; hence the Silesian method is more suitable for poor ores which do not permit much loss of zinc. Moreover, poor ores rich in earths and oxide of iron are apt to form more or less fritted deposits, which can be better removed from muffles than from retorts.

The richer the ore the lower is the temperature required for its distillation; also as the wages are less as the production is greater, the zinc produced from rich ores will be the cheapest.

**4. The Influence of Foreign Substances in the Ore.**—The basic oxides will attack the clay vessels more the longer the distilling process lasts, and the closer the contact of the ore with the inside walls of the vessel; for this reason, their influence is greater in the Silesian than in the Belgian process. Ferruginous blende and calamine are better adapted for the Belgian process, and blende of coarse grain offers less contact than finely divided ore. If fusible slags are formed

\* B. u. h. Ztg., 1861, p. 430.

during distillation they can be more easily removed from retorts than from muffles, but muffles cause less waste, owing to the lower temperature. A larger amount of lead in the ore attacks retorts more than muffles, the retorts being more strongly heated. The reduced lead collects on the moderately hot bottom of the muffle without injuring it.

According to George Darlington and Price,\* poor basic ores do not waste the clay vessels so much if the vessels are previously closed and heated with coal tar up to the caking point of the tar. Glazing† the retorts also preserves them from wasting and from loss of zinc.

**5. The Extension of the Production.**—The Belgian furnaces yield more zinc in a given time than the Silesian; these, however, allow longer operations.

**6. The Cost of Furnaces.**—Two Silesian furnaces of the older construction, erected close to each other, cost about £120, a Belgian furnace about £320; but the new large Belgian-Silesian furnaces are more expensive than the Belgian furnaces. The process in a Belgian furnace lasts for about 15 months, while in a Silesian it may be carried on for 20 months; the repairs of Silesian furnaces are also cheaper.

**7. The Skilfulness of the Workmen** required for the Belgian process is greater than that for the Silesian; also the labour in the Belgian process is more fatiguing. The wages for the new Belgian-Silesian furnace are as high as for the Belgian furnaces.

The dimensions of the furnaces and of the distilling vessels also influence the process.

It is advantageous to employ vessels of comparatively small size, with thin sides and a large surface for heating.

The various processes are all liable to cause a loss of zinc:—by imperfect condensation of the zinc vapour in the receivers; by some deficiency of the distilling vessels; by an improper preparation and drying of the ore mixture, if the ore mixture is of too basic a nature; by obstructions of the receiver, &c.

\* PERCY, Metallurgy, i., 594.

† B. u. h. Ztg., 1860, p. 92; 1861, p. 40; 1862, p. 140.

All experiments to collect the escaping gaseous zinc, either in condensation flues,\* or by means of liquids (as ammonia †), seem to have been unsuccessful. Only at St. Leonhard ‡ some of these disadvantages are obviated by employing very spacious condensing flues, connected with a ventilator.

Part of the zinc is also retained in the residues and deposits.

#### THE BELGIAN METHOD OF EXTRACTING ZINC.

This method, if coal is expensive and clay cheap, is generally best adapted for treating rich ores in a finely divided state. It requires a long-flaming coal, very good clay, and skilful workmen, and in a given time yields a greater production than the Silesian method, but the residues are richer.

The distillation furnace is chiefly required to contain the greatest possible number of distilling vessels in such a manner as to allow a uniform heating. The Silesian furnaces answer this purpose better in some respects than the Belgian. As the lower retorts of the Belgian furnaces are always heated somewhat more strongly than the upper ones, the latter are to be charged with the richest materials, which are easily reducible.

An increase of the distilling vessels up to a certain limit may, if the workmen are skilful, have a favourable result with regard to the consumption of fuel and the production of zinc; but if that limit is surpassed, these advantages may be lost, chiefly owing to the workmen's unskilfulness; or the greater loss of zinc may outbalance the advantage of greater production.

The zinc works of the Vieille Montagne mostly contain furnaces with 61 retorts, 31 of which form the lower tiers; they are each charged every twelve hours with about 24 lbs. of ore mixture, while the upper retorts are only charged with 16 lbs. These furnaces are 8 feet wide, 10½ feet high, and 6½ feet deep; the retorts are 8 inches in diameter and 3 feet 3 inches in length. Mr. Vivian's zinc works near Swansea

\* B. u. h. Ztg., 1860, p. 31; 1861, p. 429.

† B. u. h. Ztg., 1862, p. 140.

‡ B. u. h. Ztg., 1862, p. 71.

contain 78 retorts, each 3 feet 6 inches long and 8 inches in diameter, while the furnaces are 11 feet wide,  $9\frac{1}{2}$  feet high, and 4 feet deep.

The retorts, adapters, &c., are manufactured from a mixture of raw and burned clay; the burned clay is ground by edge mills, and the degree of fineness given to the clay depends on the size of the object to be manufactured. Up to a certain limit, the larger the object for which the clay is intended, the finer the clay is ground.

The burning of the clay is effected in arched furnaces 9 feet long, 7 feet broad, and 7 feet high. The sole of the furnace is also formed by a vault, about 2 feet beneath which is placed a grate  $6\frac{1}{2}$  feet long, and 2 feet broad, from which the flame enters the furnace by 24 flues, and escapes by the flues of the arched roof of the furnace. A furnace is charged with from 15 to 17 tons of raw clay, and burns for about 3 days, consuming 50 cubic feet of coal. The clay is then burned so hard that it will give sparks when struck with steel.

If intended for the manufacture of retorts, the burned clay is divided into grains about one-twelfth of an inch in size, and, after being sifted, is mixed with the raw clay which has been dried and ground. The mixture is then moistened with about 20 per cent of water.

At Altenberg, near Aix-la-Chapelle, the mixture for the lower retorts consists of 3 parts of burned and 2 parts of raw Belgian clay, and that for the upper retorts of 4 parts of raw Belgian, 3 parts raw Rhenish clay, and 8 parts of old retorts free from slag. The Rhenish clay is made suitable for the manufacture of retorts by burning it at a very high temperature, approaching to vitrification. An addition of coke is injurious, owing to the ash it contains.

The clay composition is kneaded into a paste, either by hand or by a pug mill similar to that used in Staffordshire for making pottery ware, namely a cylinder in whose axis an upright shaft revolves, bearing knives as radii to the shaft.

The retorts are mostly manufactured by means of a mould\*

\* B. u. h. Ztg., 1859, p. 406.



consisting of six semicircular pieces, which, when united with iron rings and wedges, form a retort. For the purpose of forming the bottom of the retort a massive clay cylinder is first formed, the height of one section of the mould ; sand is spread over it, and it is placed upon the floor, and the mould put so as to cover it. A hole is then formed by beating a conical rammer into the clay, and made cylindrical by removing some clay by hand. The clay is beaten against the sides of the mould with a club, and an exact cylindrical form is given by applying a templet ; this cylinder forms one piece with the bottom. Sausage-like clay strips, placed spirally, and surrounded by another part of the mould, are now moulded upon the edge of the cylinder. The inner sides are beaten against the sides of the mould, and the above-mentioned templet is again applied ; this is continued till the retort has obtained the required height. This mode of making retorts is adopted in Belgium and Westphalia ; other methods are followed in Iserlohn and Linz, but the quickest way of manufacturing retorts is in use in Angleur and St. Leonhard, in Belgium, and at Vivian's zinc works near Swansea. Wooden moulds opening longitudinally by hinges are filled with plastic clay and placed beneath a borer, which is the breadth of the diameter of the retort, and capable of being moved up and down by a machine. By means of this borer one workman is able to make from 100 to 150 retorts in 12 hours, while only 18 or 20 retorts can be made by hand in the same time. At Moresnet a bored and fired retort costs 1s. 3d., and a retort made by hand 1s. 8d.

The retorts are then dried in the air for about three weeks, and afterwards placed for two or three months in a drying chamber, which is kept at an average temperature of  $30\frac{1}{2}^{\circ}$  C. Each retort is stamped with the date on which it was manufactured, and also with a mark to identify the workman.

The retorts are put directly into the reducing furnace, when a new operation commences ; but if they are intended for replacing broken retorts while the operation is proceeding, they must be previously and very gradually heated in separate furnaces.

The construction of the Belgian furnaces in common use is represented by Figs. 114, 115.\*

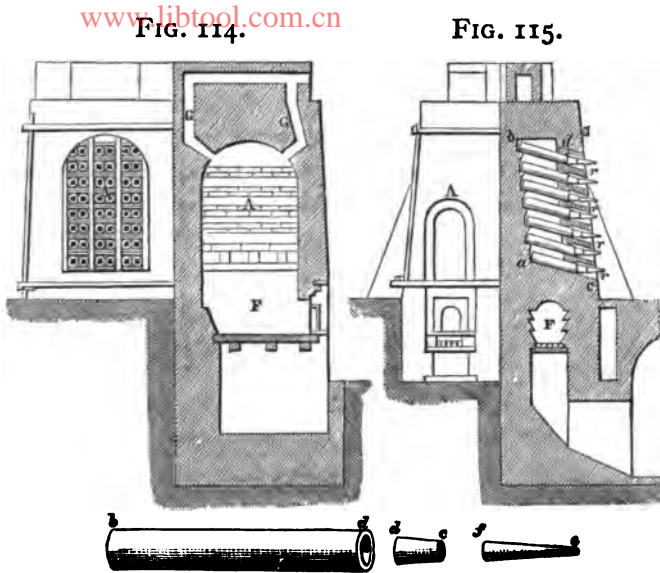

Fig. 114, represents on the left hand, a front elevation of the furnace, and on the right, a sectional elevation through the ash-pit and fire-place. *F* is the fire-place, whilst *A* is the cavity into which are introduced the retorts used for the distillation of the metal. The products of combustion escape by the openings (*G, G*) into a flue, by which they are either conducted into the calciner for the purpose of economising the waste heat, or into the chimney.

These furnaces are arranged either in pairs, back to back, or in groups of four, for the purpose of rendering the structure more solid, and of economising the heat. In the arched chamber (*A*) are placed 48 or more cylindrical retorts, 3 feet 6 inches in length from *b* to *d*, and 7 inches in internal diameter. These are supported behind by ledges of masonry (*a, b*), Fig. 115, whilst in front, at *c, d*, they rest on fire-clay saddles, let into an iron framing. Short conical fire-clay pipes, 10 inches in length from *d* to *e*, are fixed in

\* Dr. URE'S Dictionary of Arts, &c., iii., 1,123.

the mouths of these retorts by means of moistened clay, and project for a short distance beyond the mouth of the furnace. To these are adapted thin wrought iron cones, 18 inches in length from *e* to *f*, tapering off at the smaller extremity to an orifice about three quarters of an inch in diameter, which serves to collect the zinc dust; they are mostly used in England. Those used on the Continent are of a different form, and without an orifice, as shown by *h* in Fig. 116; and these seem to be preferable. The inclined

FIG. 116.

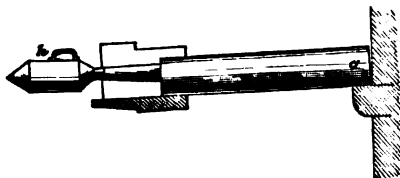

position of the retorts, the method of adjusting the pipes, and the general arrangement of the apparatus is shown in Fig. 115, in which *r, r, r, r*, represent the nozzles of thin wrought iron.

Contrary to the plan shown in the above drawings, the furnaces used on the Continent are furnished with an inclined grate, in order to concentrate the heat in the furnace.

When a new furnace is first lighted, the retorts are introduced without being previously baked, but care must be taken that they be perfectly dry and well-seasoned, and a large stock should be kept constantly at hand, in a storehouse artificially heated by some of the flues of the establishment. The heat must be gradually increased for three or four days, at the end of which period charges of ore are introduced, the clay cones are luted in their places, and the furnace brought into full working order. The charge of a furnace differs according to the number and size of the retorts. The ore and coal dust, after being finely divided and thoroughly mixed, are slightly damped, and then introduced into the retorts by means of a semi-cylindrical scoop, with which an experienced workman will effect the

charging without spilling any of the mixture; the mixture is pressed in the lower part of the retorts, and kept looser in the upper part.

The retorts in the lower tier are not usually charged, as they are extremely liable to break, and are, therefore, only employed to moderate the heat of the furnace. In cases where the fire-place is covered by a hollow arch, every retort requires a charge of ore.

As soon as the retorts have been charged, the clay cones are luted into their places, and carbonic oxide gas quickly makes its appearance, burning with a blue flame at the mouth of the cones. The quantity of this gas gradually diminishes, and as soon as the flame assumes a greenish white hue, and white fumes are observed to be evolved, the sheet-iron cones are put on, and the furnace at once enters into steady action. From time to time, as the iron cones become choked with oxide, they are taken off and gently tapped against some hard substance to remove the oxide, and are then replaced. The oxide thus collected is added to the mixture prepared for the next charge. After the expiration of about six hours from the time of charging, the wrought iron tubes are successively removed, and the metallic zinc scraped from the clay pipes into an iron ladle. This, when full, is skimmed, and the oxide added to that obtained from the nozzles, whilst the pure metal is cast into ingots, each weighing about 30 lbs. Twelve hours after the charging, the zinc is again tapped, and the residue remaining in the retorts withdrawn. The retorts are immediately re-charged, and the operation of reduction is again conducted as described.

The residues obtained from the retorts after the first working, are passed through a crushing mill, mixed with a further quantity of small coal, and again treated for the metal they contain. When unfit for further service, the earthen adapters or cones are crushed and treated as zinc ores.

In order to work these furnaces economically, it is very important that they should be constantly supplied with a full number of retorts, since the amount of fuel consumed,

and the general expense incurred for each furnace, will be the same if the apparatus has its full complement of retorts, or if one half of them is broken.

It is necessary, therefore, that in all zinc smelting establishments, a large stock of well-seasoned retorts should be kept; and that, before being introduced into the furnace, they may be heated to full redness in a kiln provided for that purpose, in case of any deficiency caused by breakage.

The Belgian process of zinc smelting is that most employed in this country. The principal places in which zinc ores are treated are Swansea, Wigan, Llanelly, and Wrexham.

### Illustrations of the Belgian Process.

*a. Treatment of Calamine.*—At Moresnet,\* (Vieille Montagne), near Aix-la-Chapelle, calamine occurring in the neighbourhood is partly calcined in large kilns, and partly in reverberatory furnaces, after having been ground by edge mills and combined so as to contain 50 per cent of zinc.

100 lbs. of ore mixture are then mixed with 45 or 46 lbs. of coal. The older furnaces, having 52 retorts, produce daily 6 or 7 cwts. of zinc from calamine yielding from 35 to 37 per cent; they consume daily 28 cwts. of flaming coal, and 10½ cwts. of non-caking coal, per furnace.

The new furnaces, with 61 charged retorts (the lower ones containing 24 or 25 lbs., and the upper ones 12 or 14 lbs., or an average 20 lbs. of ore each), produce in 24 hours from 24 cwts. of calamine, with 50 per cent of zinc, from 900 to 940 lbs. of zinc, including that contained in the zinc dust, equal to 38 or 39 per cent; whilst they consume 63 cubic feet of flaming coal, and 21 cubic feet of reduction coal. In 24 hours one mixture of 20 cwts. 70 lbs. of ore, and 10 cwts. 98 lbs. of coal, yielded in one furnace, 742 lbs. of zinc, and 74 lbs. of zinc dust, altogether 39 per cent, and

\* Ann. d. min., 4 sér. 1 livr., 1844, de p. 165; 2 livr., de 1844, p. 227. Bgwkfd. x., 245, 264, 273. V. CARNALL'S Preuss. Ztschr., ii., Bd. 1, Lief., p. iv. B. u. h. Ztg., 1859, p. 304. Ibid. 1860, p. 4. Ztg. f. d. deutsche Berg-u. Hüttenwesen, 1859, No. 12.

consumed 1 ton  $9\frac{1}{2}$  cwts. of coal for heating, 3·8 retorts, 11 clay tubes, and 0·6 lbs. of fire-bars. On an average, one furnace uses up three retorts daily.

The average loss of zinc amounts to about 11 per cent, half of which is contained in the residues; the calamine worked is of good quality, and therefore yields a very pure zinc. One retort costs from 1s. 7d. to 1s. 8d.; a clay cone about 1·4d., and 1 ton of best refractory bricks about £2 4s.

The zinc works at Angleur and St. Leonhard,\* in Belgium, work in a similar way, partly the above ore and partly Spanish calamine.

*b. Treatment of Blende.*—At Corphalie,† near Huy, in Belgium, blende is roasted in reverberatory furnaces, either with direct firing, or by the gases escaping from the reduction furnaces. An older furnace, containing 40 retorts, was charged with 18 cwts. of blende and some calamine, and 19 cubic feet of coal; in 24 hours it produced 6 cwts. of zinc, and 80 lbs. of grey zinc dust, consuming 38 cubic feet of coal for heating the furnace.

The process may be carried on in one furnace for six or eight months; 1 ton of clay from Andenne costs 16s.; each retort costs 1s. 7d., and 1 ton of fire-bricks, £1 5s. In 22 hours 1 furnace consumes 3 retorts, and 0·8 piece of cone, which are here made of cast-iron, instead of clay. The production of 1 cwt. of zinc costs altogether about 19s. 3d.

Formerly, 557 tons 14 cwts. of raw blende yielded 460 tons 9 cwts. of roasted blende in one month, costing £215 16s., or 9s. 2d. per ton of ore.

In 20 furnaces, or in 620 days, were reduced 413 tons 14 cwts. of roasted blende, 68 tons 17 cwts. of calcined calamine, 37 tons 13 cwts. of oxide from the cones, and 4 tons 5 cwts. of waste from the rolling mills, in total, 524 tons 9 cwts.; yielding 140 tons 5 cwts. of zinc from blende and calamine, 33 tons 7 cwts. of zinc from the oxide, and 2 tons

\* B. u. h. Ztg., 1860, p. 30. Ann. d. min., 4 sér., v., 165, 227. Bgwkd. x., 245, 264, 272.

† Ann. d. mines., 1 livr., de 1844, pp. 202, 269. Bgwkd., x., 270, 282.

15 cwts. of zinc from the waste; or on an average per day and per furnace—

Charged ore . . . . .	18 cwts. 34 lbs.
Produced zinc . . . . .	5 " 50 "
" oxide . . . . .	— " 47 "
Consumption of retorts . . . . .	2'99 pieces.
" coal . . . . .	57 cubic feet.
" cones of clay . . . . .	0'82 piece.
" cones of cast-iron . . . . .	0'75 "
Iron fire-bars . . . . .	1'75 "
Total yield . . . . .	32'31 per cent.

The smelting cost amounted to £916 16s., or to 10s. 3d. per cwt. of zinc.

#### THE SILESIAN METHOD OF EXTRACTING ZINC.

In Silesia this process allows the profitable treatment of poor ores while employing non-caking coal and an inferior clay, but it has also been introduced into Belgium and Westphalia for the treatment of rich ores and the use of flaming coal in cases where coal is cheap and clay expensive. This method allows a very cheap production in Silesia (the cost for producing 1 cwt. of zinc amounted in 1860 to 10s. 9d., whilst the ores treated yielded 15·89 per cent) owing to the cheapness of the raw materials and the peculiarities of the process itself.

The furnaces employed differ in their construction, and depend chiefly on the quality of the coal. In the one kind of furnace the combustion gases are conducted upwards (Silesian system), and in the other downwards (Belgian-Silesian system).\*

#### Silesian System.

The furnaces are either with or without a chimney; they are used without a chimney when employing non-flaming coal, which is consumed much more rapidly than bituminous coal, and which does not allow the use of so much draught as is caused by a chimney. Experiments prove that the burning coal formed small pieces of coke which fell through the grate,

\* Schles. Wochenschr., 1859, No. 34. B. u. h. Ztg., 1860, p. 328.

allowing cold air to enter, and so causing a cooling of the furnace, which interrupted the process and gave rise to the formation of richer residues. The escaping flame is partly used for seasoning the muffles and re-melting zinc. It then enters the smelting-house, interfering with the health of the workmen, and preventing them from attending regularly to the process.

These disadvantages have been considerably lessened in some newer works in Silesia by enlarging the smelting-houses and making the furnaces higher.

But the consumption of coal in these furnaces still amounts in Silesia to 20 parts for 1 part of zinc, while the same kinds of furnace in the smelting works near Swansea, but furnished with a chimney, only use 11 or 12 parts of bituminous coal to 1 part of zinc.

Different suggestions and experiments have been made to improve the construction of the furnace, and to allow a better use of the non-bituminous coal\*. The suggestions of Klemann† are those most worthy of consideration.

Experiments have also been tried to economise fuel by an increase in the number of muffles, but it has been found that furnaces with 20 muffles are the best with regard to the yield of zinc. At Silesiahütte, furnaces with respectively 24, † 26, 28, and 30 muffles have been used, and a comparison of the results of different furnaces shows that the absolute production increased a little, as well as the relative consumption of fuel, and that the yield decreased as stated in the following table:—

Number of Muffles.	Treated Ore. Cwts.	Consumption of Fuel. Cwts.	Production of Zinc. Cwts.	Consumption of Fuel per Cwt. of Zinc. Cwts.	Yield in per cents. Cwts.
20	53·55	138·55	10·30	13·42	19·20
24	60·70	152·00	10·85	14·00	17·49
30	67·83	178·60	11·48	15·55	16·89

Furnaces with a greater number of muffles are advan-

\* B. u. h. Ztg., 1861, p. 352; 1849, p. 277; 1850, p. 667. KARST., Arch., 2 R., xxii., 516; xxiii., 729.

† KLEMMANN, Zinkgewinnung Oberschlesiens, 1860, p. 29.

‡ B. u. h. Ztg., 1861, p. 398 (with drawings), p. 429.



tageously employed in England,\* Belgium, and Westphalia,† where bituminous flaming coal is burned, but they require very skilful workmen.

The clay used for the manufacture of the muffles is prepared in the same way as that for retorts, only the burned clay is somewhat less finely ground (to 3 or 4 millim.). It is then mixed with about 16 per cent of water and kneaded, either by hand or machinery, to as firm a consistence as possible. The single parts forming the muffle must, like the retorts, be intimately united, and the manufacture carried on without interruption. In most smelting works in Silesia the muffles are formed by hand.

Polonian clay, mixed with  $\frac{1}{2}$  part of old muffles, and pounded and sifted, is employed. The clay mixture is moistened and kneaded by hand to a paste, and then a massive prism of the same breadth as the muffle is formed. By excavating this, the bottom and side walls of the muffle are formed. A clay plate is placed upon and joined to them, and by beating the inside with a wooden hammer, the proper form of the muffle is produced. The muffles are dried in the atmosphere for about two weeks, and then kept in a drying chamber for some months.

The moulds employed for the manufacture of muffles are formed of separate parts, which are covered with linen, and have sides movable on hinges. In these moulds the muffles are either made of clay strips, as in Llansamlet,‡ near Swansea, or of clay plates,|| as in Belgium and Westphalia.

The durability of the muffles formed by moulds seems to be about equal to that of muffles formed by hand.

The muffles of the Silesian zinc works are from  $4\frac{1}{2}$  to 5 feet long, 6 inches wide (inside), and from 18 to 20 inches high. On an average those of Belgian, Westphalian, and Rhenish zinc works are 1.3 metres long, 0.55 metre high, and 0.15 metre wide inside.

In Upper Silesia the muffles are still frequently burned in

\* PERCY, Metallurgy, i., 563.

† B. u. h. Ztg., 1860, (pp. 33, 46.

‡ PERCY, Metallurgy, i., 559.

|| B. u. h. Ztg., 1859, p. 406.

furnaces attached to the distilling furnaces, the gases escaping from which heat the former; but in many zinc works furnaces with direct firing are now used for this purpose, as they allow the muffles to be heated more strongly; this increases their durability so much as to counterbalance the expense for firing.

These furnaces are all of similar construction; those used at Llansamlet, near Swansea,\* are represented by Figs. 117 and 118. The fire-place with the grate (*a*) has an arched roof

FIG. 117.

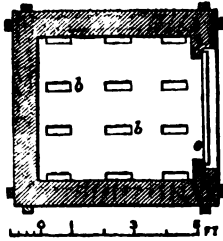
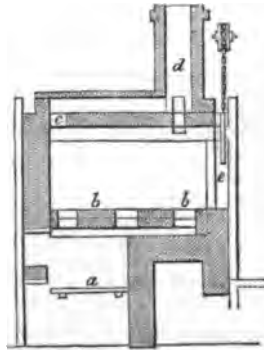

FIG. 118.



furnished with 12 openings (*b*), through which the flame enters the furnace. It escapes by the flues (*c*) into the chimney (*d*); the opening of the furnace for placing in the muffles can be closed by an iron door (*e*); a muffle is sometimes kept for seven weeks in the hottest part of the furnace, and in the other parts for 10 or 12 weeks more.

\* PERCY, Metallurgy, i., 561.

The adapters are made either by hand, as in Upper Silesia,\* or in moulds, with less refractory clay, as in Llansamlet, near Swansea.† They are then dried and burned.

www.libtool.com.cn

FIG. 119.

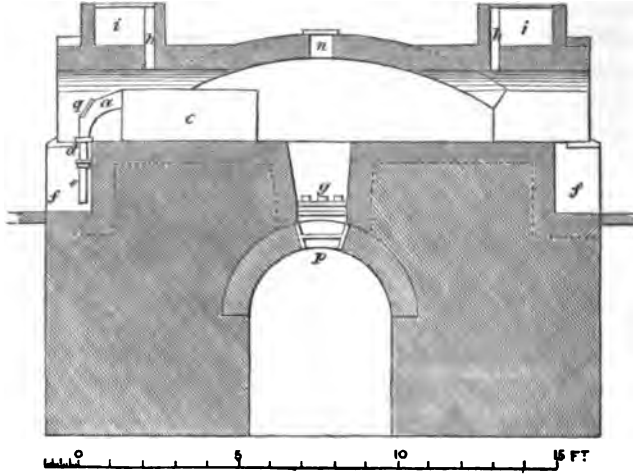
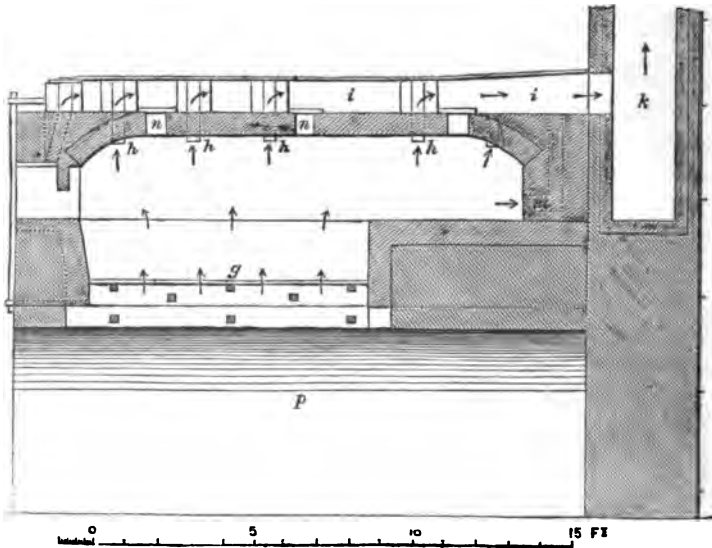

FIG. 120.



\* B. u. h. Ztg., 1861, p. 413.  
 † PERCY, Metallurgy, i., 561.

It has been before mentioned that the muffle furnaces in Silesia are without chimnies, whilst in England they have them. These English furnaces are shown by Figs. 119 and 120. The flame is conducted into the chimney (*h*) by two rows of flues (*h*) in the arched roof, and by the lateral channels (*m*); both *h* and *m*, joining in the horizontal channel *i*. The openings (*n*) in the arched roof serve for repairing the muffles which have become deficient. *c* is the muffle, *g* the grate, and *p* the vaulted ash-pit. The construction of muffle and adapters is to be seen in Fig. 121. The clay body (*a*)

FIG. 121.

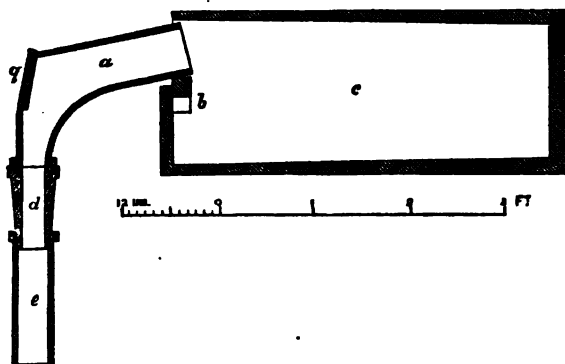

rests at one end upon the support (*b*), in the muffle (*c*), and is joined at its other end to a cast-iron conical tube (*d*), which again is joined to the plate iron tube (*e*), which reaches nearly to the bottom of the place on which the reduced zinc will drop (*vide* Fig. 119). The opening on the top of the adapter (*a*) is closed by a clay plate (*g*).

Newton\* also conducts the flame under the bottom of the muffles, and the zinc vapour into a condenser after it has passed through a layer of glowing coal.

A new furnace is first dried for several days in the atmosphere, and then carefully and gently heated with the air excluded. The muffles are now placed, and the out-sides surrounded with brick wall to protect them from the flame. All side openings are closed as much as possible, and the firing is gradually increased, until, after a lapse of

\* Polyt. Centr., 1857, p. 793.

seven or eight days the furnace becomes so hot as to allow the charging of the muffles. The protecting walls are removed, and the spaces between the muffles and partition walls are filled up with bricks and fire-clay; the adapters are fixed to the muffles, and a light charge of mixture is introduced by means of the opening (*q*) in the clay adapter (*a*). A full charge is not given until three or four of the light charges have been made. The new muffles absorb much metal, unless they are glazed. A furnace in normal operation is charged every 24 hours; the fused zinc from the adapters, and the residues from the muffles being first removed, for which purpose the muffles are provided with an aperture below that to which the adapter is fixed, and which is kept closed by a clay plate.

#### Illustrations of the Processes for the Treatment of Calamine.

A. At the zinc works at Upper Silesia.\*—About 40 such works exist in Upper Silesia, and they are concentrated at the different places where the calamine occurs in nests. The calamine is mixed with loam or dolomite, and frequently associated with iron ore, galena, and zinc blende; the iron ore occurs sometimes in such large quantities that it is profitably worked; the calamine contains on an average from 18 to 20 per cent of zinc.

It may here be mentioned that the statements of the amount of zinc in the ores in Silesia are always made with regard to raw ore, and that the amount is determined empirically by smelting the ores in a small furnace, and includes the loss in smelting.

The zinc works in Belgium and Westphalia, on the other hand, make their statements for calcined ores, the metallic contents of which are determined by analyses. The statements, therefore, do not allow a direct comparison; the Silesian raw calamine, for instance, stated to contain  $22\frac{1}{2}$

\* MANES in *Ann. d. min.*, 1 sér., xii., 249; CALLON, *Ibid.*, 3 sér., xvii., 45; RIVOT, *Ibid.*, 2 livr., de 1848. DELESSE, *Ibid.*, 4 sér., tom. iv., p. 377; tom. vi., p. 213. JULIEN, in *B. u. h. Ztg.*, 1861, p. 396. L. KLEMMANN, *die Zinkgewinnung in Oberschlesien. Mit Zeichnungen.*, Breslau, 1860. *B. u. h. Ztg.*, 1860, p. 163.

per cent, would contain 32·13 per cent in the calcined state, calculating that the loss of calcination amounted to 30 per cent; and when taking into consideration the 10 per cent of loss in the extraction, it would even contain 42·13 per cent of zinc.

The cost for coal is, on an average, 2½d. per cwt., and for small coal only about 1d. The Silesian clay costs about 7d. per cubic foot; this clay is used in admixture with Polish clay, which costs about 1s. 2d. per cubic foot.

According to Julien,\* one furnace produces, in 24 hours, from 14 to 16 cwts. of ore containing 15 or 16 per cent, 1·06 to 1·16 cwt. of zinc. The price of calamine at the mine is 7½d. per cwt., and 1·5d. for carriage to the smelting works; 1 ton of coal costs 5s. 2d., 1 muffle about 4s. 3d., and a melting pan 4s. 11d. One part of zinc consumes 20 parts of coal, and from 3 to 3½ muffles are consumed for every 1 ton of produced zinc; 1 muffle will last about 47 days. Two semi-detached furnaces cost £120, and £280 including the melting house.

The loss caused by the process is about 25 per cent; ores containing 20 per cent will, therefore, only yield 15 per cent. According to Klemann, the total loss of zinc amounts to 30 or 33 per cent of the zinc contained in the ore. The residues usually contain 2 per cent if the process has been carried on well, but sometimes as much as 8 per cent.

In 1860, the total production of zinc in Silesia amounted to 40,811½ tons.

The largest of the zinc works in Silesia, belonging to the Silesian Company, is Silesiahütte; † it contains 180 furnaces. The furnaces with 20 muffles are charged daily with 16 cwts. of calamine, those having 24 muffles with 18 cwts., and those with 26 muffles with 1 ton. One furnace consumes on an average 370 cubic feet of coal, and yields 17 per cent of zinc; it produces annually 50 tons of zinc.

The Silesian Company produced in 1859, in all their zinc

\* B. u. h. Ztg., 1861, p. 414.

† B. u. h. Ztg., 1859, p. 99; 1860, p. 244; 1861, p. 395; 1862, p. 344.

works, with 226 furnaces, 9,880 $\frac{1}{2}$  tons of raw zinc, at the following cost per cwt. of raw zinc :—

[www.libtool.com.cn](http://www.libtool.com.cn)

	£	s.	d.
For calamine . . . . .	0	2	10·6
„ zinc ash . . . . .	0	0	1·1
„ carriage of the calamine . . . . .	0	0	7
„ coal . . . . .	0	3	10·5
„ fire-clay, &c. . . . .	0	0	7·7
„ cast and wrought iron . . . . .	0	0	1·3
„ wages . . . . .	0	1	11
„ general cost . . . . .	0	0	4·7
„ repairs . . . . .	0	0	5·4
„ leases . . . . .	0	0	0·7
„ sundries . . . . .	0	0	1·2
			<hr/>
Total . . . . .	£0	11	1·2

From these are to be deducted for  
sundry receipts . . . . . 0 0 0·3

Leaving a total cost of . . . . . 0 11 0·9

In 1861, 274 furnaces produced 11,926 tons of zinc, at a cost of 10s. 9·6d. per cwt. The average selling price of 22 years amounted to 17·67s. per cwt. The selling price was lowest during the years 1848-49, when it amounted to only 10·8s.

In 1858, the zinc works of the Silesian Company produced from 29,243 tons of calamine, 4,117 tons of zinc, equal to a yield of 14·01 per cent; 221 furnaces were in operation; 1 furnace worked 13·8 cwts. of ore per day, and produced 2·22 cwts. of zinc, at a consumption of 46·5 cwts. of coal; the production of 1 cwt. of zinc cost 14s.

In 1859, the 44 zinc works in operation in Upper Silesia\* produced from 224,125 tons of calamine, 39,031 tons of zinc, equal to a yield of 16·12 per cent, consuming 612,377 tons of coal. 1,569 lbs of coal were consumed for the production of 1 cwt. of zinc, and the average cost was 12s. 6d. per cwt., of which 33 per cent was expended for coal, 17 per cent for wages, and 9 per cent for muffles and repairs.

\* B. u. h. Ztg., 1860, pp. 327, 400; 1861, p. 263.

B. The Zinc Works near Stolberg,\* work calamine as well as blende, partly by the old Silesian method, and partly by the Belgian-Silesian mode.

In the Zinc Works at Steinfurth,† calamine is treated in furnaces with 20, 24, and 28 muffles. Those with 20 muffles are charged every 24 hours on both sides, while the other furnaces are charged only on one side; therefore, the furnaces with 20 muffles work a larger quantity, but with a lower yield. The space for each muffle in the furnaces with 20 and 24 muffles is 22 inches broad, and that in furnaces with 28 muffles is 26 inches; in consequence of which the latter furnaces consume more coal, but their yield is larger. In furnaces with 28 muffles the yield amounts to 34·2 per cent; in furnaces with 24 muffles to 30·7 per cent; and in those with 20 muffles to 25·2 per cent; the average yield of calcined ore amounts to 30 per cent, and to 21·6 per cent of the raw ore, supposing the raw ore to lose 28 per cent in weight by the calcining process. Eight cwts. of calamine are calcined in six hours by means of the flame escaping from the reducing furnaces. The calamine is mixed with from 40 to 48 per cent of non-caking coal for the purpose of reduction. 344 muffles produced in one month from 283½ tons of calcined calamine, 83½ tons of zinc; consuming 739½ tons of coal for heating the furnaces, and 161 tons of reducing coal, besides 120 muffles. The yield of the raw ore amounted to 24·5 per cent, and that of the calcined ore to 29·5 per cent. The expenses for wages were £180. The muffles which are manufactured of 1 part of Andenne clay, and 2 parts of old burned clay, cost 4s. a piece; a clay cone cost 3·35d.

The cost for the production of 1 cwt. of zinc amounts to £1; namely, 10·9s. for ore, 5s. for coal for heating the furnace, 0·87s. for reduction coal, 2·22s. for wages and premiums, 0·21s. for tools, 0·51s. for muffles, cones, &c., 0·27s. for superintendence, and 0·12s. for sundries.

\* Ann. d. min., 4 sér., x., 511. B. u. h. Ztg., 1847, p. 289; Bgwkd., vi., 10; xvii., 321.

† B. u. h. Ztg., 1860, pp. 92, 495.



### Illustrations of the Processes for the Treatment of Blende.

At Heinrichshütte, near Münsterbusch, in the Stolberg district, 12 cwts. of ground blende are roasted in a reverberatory furnace for 24 hours, and consume 46 cubic feet of coal, causing a loss of 16 per cent. Three cwts. of raw ore, containing 45 per cent of zinc, yielded by the reduction process 1 cwt. of zinc, which is equal to 33 per cent, consuming 11 cwts. of coal, at a cost of £1.

The muffles are made either in vertical moulds, in which one workman will make three in a day at 7<sup>s</sup>8d. each, or in moulds placed longitudinally on the floor, in which case one workman is able to turn out six or seven muffles per day at 3<sup>s</sup>9d. each. The completed muffles are dried by standing close to a stove for one day; they are then kept in a heated chamber for four or five weeks, and afterwards in store for at least a year. One dried muffle weighs 180 lbs., costs 5s., and lasts, on an average, 70 days.

In 1860 these zinc works produced about 3,259 tons of zinc.

At Friedrichs-Wilhelmhütte, near Stolberg, blende of Bensberg, Dipenlienchen, Spain, &c., containing 45 per cent of zinc, is worked. The roasted blende contains 53<sup>5</sup>/<sub>10</sub> per cent of zinc, as the loss of roasting amounts to 16 per cent; and the yield of the raw ore by the reduction process is 32<sup>4</sup>/<sub>10</sub> per cent and 1<sup>8</sup>/<sub>10</sub> per cent of zinc dust; the zinc dust again yields 90 per cent of zinc. The total loss of zinc amounts to about 27 per cent, and in 24 hours one furnace produces as much as 44 lbs. of zinc dust, or nearly four per cent of the roasted ore. The residues in the muffles contain from 9 to 13 per cent of zinc. The ore is mixed with from 55 to 60 per cent of coal for the purpose of its reduction, and the heating coal is about four times the weight of the raw ore treated. In 24 hours one furnace consumes altogether about 70 cubic feet of coal. One muffle weighs 105 lbs., and costs 7<sup>2</sup>/<sub>10</sub>d. to make; it lasts 92 days or more.

2<sup>3</sup>/<sub>4</sub> tons of blende are roasted daily in one reverberatory furnace; the expenses are—

	£	s.	d.
2½ tons of blende . . . . .	9	5	0
4 workmen (wages) . . . . .	0	7	0
142 cubic feet of coal . . . . .	0	4	4

46 cwts. 36 lbs. roasted blende cost £9 16 4

In 1861, 3,505 tons of zinc were produced, for which 290 workmen and 35 furnaces were employed.

At Llansamlet, near Swansea,\* argenteriferous blende is roasted, the silver extracted by the wet way, and the residue treated for the production of zinc in reduction furnaces with 24 muffles. These muffles are charged with 1,568 lbs. of desilverised blende, 150 lbs. of the zinc dross of the re-melting on the previous day, 5 cwts. of pure bituminous coal, and 2 cwts. of cinders. Each muffle contains 71 lbs. of zinciferous products; the muffles nearest the fire-place are charged with larger quantities than the other muffles. Two workmen remove the residues and charge the two muffles standing under one arch, at six o'clock in the morning, which operation takes three or four hours. About five hours afterwards, the condensation of zinc commences in the receivers, and continues till three or four o'clock on the following morning, but it decreases towards six o'clock, when the removing and re-charging is effected; the resulting zinc is re-melted in iron pans.

Roasted blende, containing 43·4 per cent of zinc, yields 36 per cent. The loss of zinc in the roasting process amounts to 1½ per cent, in the reducing process to 7·4 per cent; 9 per cent in all. The consumption in 24 hours amounts to 1 ton 4 cwts. 2 qrs. of bituminous coal to 1 ton 8 cwts. of non-caking coal, and to 5 cwts. of cinders, altogether to 2 tons 17 cwts., 2 qrs., or nearly 11½ tons per 1 ton of zinc. The operations of one furnace lasts about 13 months, and every four years the furnace has to be rebuilt from the grate upwards. The muffles are charged with but little ore at the commencement of the operation till the seventh day, when the full charge is given. New muffles absorb large quantities of metal.

\* PERCY, Metallurgy, i., 558.

**THE BELGIAN-SILESIAN SYSTEM OF EXTRACTING  
ZINC.**

The furnaces used in this method are so constructed as to conduct the flame round the muffles, and then beneath the furnace into a flue which communicates with a chimney. This arrangement does not allow the use of the escaping flame for calcining and other purposes, but it effects a more uniform heating of the muffles, and their lower part is especially better heated than in the old Silesian furnaces; the smoke which is so very troublesome to the workmen in the Silesian furnaces, is also avoided, and the fuel is considerably economised. Bituminous flaming coal must be employed; if the muffles of these furnaces become defective they usually cause a larger loss of zinc than defective muffles in common Silesian furnaces. These furnaces also differ from the old Silesian furnaces in allowing the liquid zinc to run direct from the adapters into moulds.

In order to increase the production and economise the fuel, the muffles have been enlarged and increased in number, namely, from 20 to 24, 28, 32, 36, or even 40. Furnaces with 32 muffles are the most common. One muffle requires about 1 cwt. of ore in 24 hours.

Experiments have been made at Valentin Cocq and Flone:—*a*, with furnaces having 24 muffles, 1.30 metres long, 0.55 metre high, and 0.22 metre broad; *b*, with furnaces of 28 muffles of the same dimensions; *c*, with furnaces of 32 muffles and the same dimensions; and *d*, with furnaces having 32 muffles, each 1.4 metres long, 0.6 metre high, and 0.22 metre broad, and in 24 hours the following results were obtained from one furnace:—

	Charge.		Zinc Production		Coals for heating.	Muffles used.	Adapters used.	Clay Stoppers used.	Clay Plates used.
	Calamine lbs.	Coal lbs.	24 hours.	in per cents.					
<i>a</i> .	1160	300	454	39.20	3616	0.40	2.0	1.0	14
<i>b</i> .	1360	350	544	39.65	3806	0.35	2.3	1.7	18
<i>c</i> .	1560	400	624	40.00	4094	0.37	2.3	2.0	20
<i>d</i> .	1840	460	698	38.00	4286	0.41	2.4	2.0	20

The furnaces, *a*, *c*, and *d*, consumed respectively 796, 656, and 614 lbs. of fuel per 100 lbs. of zinc, and the wages amounted respectively to 1s. 11.6d., 1s. 5.7d., and 1s. 3.3d.

The adapters rest, as in the Silesian furnaces, upon a support which at the same time divides the front of the muffle into two parts, the lower of which serves for removing the residues. The adapters are of different constructions at Valentin Cocq.\* They consist of a tube (*v*) (Fig. 122), fur-

FIG. 122.



nished with a swelling on its lower side; its aperture in the front is closed by a clay plug (*s*).

At the zinc works in Moriston,† near Swansea, the adapters (Fig. 123) are provided with apertures above their lowest

FIG. 123.

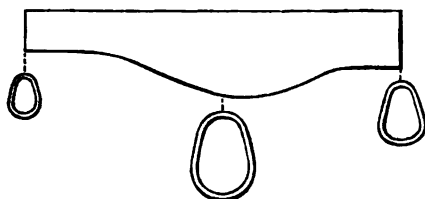

points which are closed with clay plugs, so as to allow the zinc to be tapped off from different levels; it is therefore of varying purity. If the ores contain an amount of lead which becomes volatilised, it will condense and remain in the swelling of the adapter, and thus a purer zinc results.

The same result is obtained by the arrangement at Borbeck‡ (Fig. 124). The adapter (*a*) resting upon an iron sup-

FIG. 124.

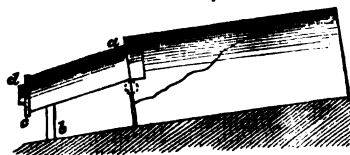

\* B. u. h. Ztg., 1860, p. 47.

† Ibid., 1861, p. 430.

‡ Ibid., 1860, p. 100.

port (*b*) is hermetically closed by a luted clay plate (*c*), behind which the zinc collects. Zinc can be made to run out by a tapping hole. On its upper part the clay plate has an opening two inches wide for the escape of the gases, and this aperture is surrounded by a circular projection (*d*), to which the vessel for receiving the zinc dust may be fixed.

The construction of a Belgian-Silesian furnace with 32 muffles is shown in Figs. 125, 126, 127, 128, and 129. *a, a,* are

FIG. 125.

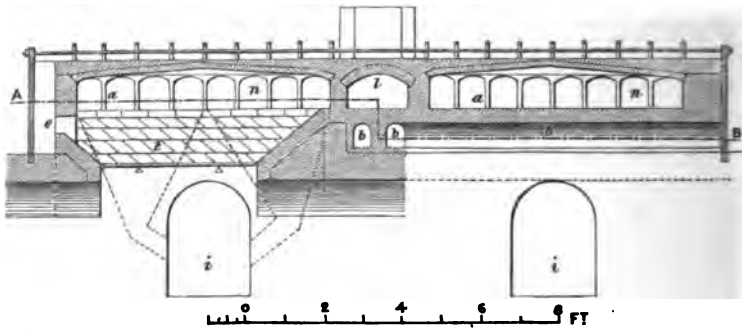

FIG. 126.

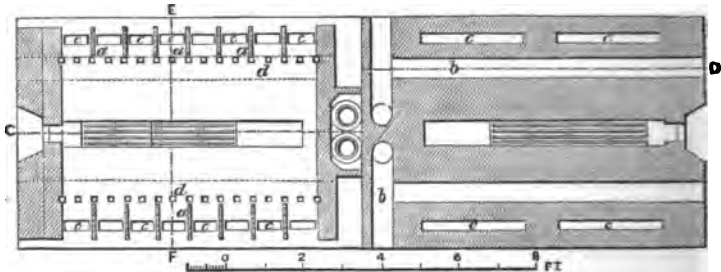

FIG. 127.

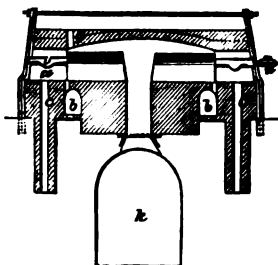

FIG. 128.

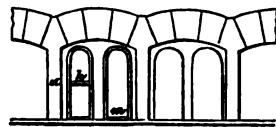

FIG. 129.



partition walls forming niches, each for the reception of two muffles; they also support the arched roof of the furnace, and allow the muffles to be fixed by their front, and keep off any cold air which may enter; *b, b*, are channels conducting the flame near to the mouths of the muffles by means of the flues (*d*). These flues are larger the farther they are from the fire-place (Moriston, near Swansea), in order to induce a more uniform distribution of the flame. The channels (*b, b*) either communicate with the clay tubes (*f*) (Valentin Cöcq), 8.6 metres high, 0.45 metre upper and 0.35 metre lower diameter, which are formed in moulds,\* or the flame of all the furnaces is conducted into one chimney; *c, c*, are channels for receiving residues, which fall into the vaulted space (*i*), which crosses the chief vault (*k*); *k* is used for working under the grate, for collecting and removing the ash, &c.; *e*, an opening for charging fuel; *g*, flue for letting the flame escape, as in the old Silesian process; *h*, the bridge or support in the muffles for the adapters to rest upon; *l*, space between two furnaces, formerly used for calcining calamine, and now for re-melting zinc, except in larger furnaces where it is now done away with; *m*, muffles standing with their backs somewhat higher, and two inches distant from the partition walls (*a*). As the fire-place becomes enlarged, the muffles are moved to the front, often up to the channel *c*; *n*, are niches; *o* (Fig. 129), is a door or frame for the niches, constructed of strong band-iron, and coated with loam. The mouths of the adapters (*p*) project from the upper part of that frame, whilst its lower open part (*q*) may be closed with a door (*r*), coated with loam if the temperature of the adapters requires it. If adapters are employed, like *a* in Fig. 124, the whole frame (*o*) is not required, but only the door (*r*), and the upper part may be walled up with bricks; *u* is a receiver fixed to the adapter (*v*); *t* is the fire-place constructed of the best fire-bricks of the form shown. The walls (*a*), the hearth sole, and the places where the channels (*b*) join, also require bricks composed of the materials used in the manufacture of the muffles.

\* B. u. h. Ztg., 1860, p. 31.

A good furnace lasts on an average two years, and consumes about eight muffles per month.

At the zinc works at Birkengang,\* near Stolberg, furnaces are constructed with two rows of muffles one above the other, as shown by Fig. 130. The upper muffles (*a*) are longer than

FIG. 130.

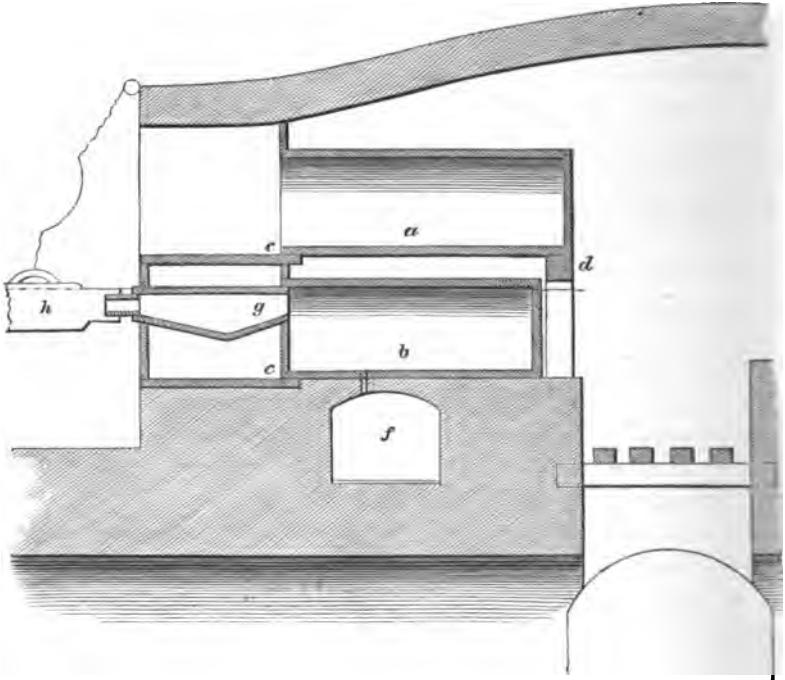

the lower muffles (*b*) by 10 centim.; both are 0·21 metre broad. Their front is placed upon an inclined iron plate (*c*), and their back on the wall (*d*), which is constructed of fire-bricks, and rests upon pillars standing between the niches. One of these furnaces has 60 muffles, 3 in each niche, 0·84 metre wide. The partition walls are 0·1 metre thick. The flame rises from the fire-place (*e*) to the arched roof, plays completely round the upper muffles, and passing the spaces between the upper and lower muffles, enters the channel (*f*), which communicates with the chimney. As the upper muffles are exposed to a higher heat, they are somewhat larger, and

\* B. u. h. Ztg., 1861, p. 407; 1862, p. 140.

require to be oftener replaced than the lower ones. The muffles are furnished with adapters (*g*), and with receivers (*h*), which are suspended on iron wire.

One of these furnaces with 60 muffles consumes about 95 cubic feet of coal in 24 hours, while the old furnaces with 30 muffles consume about 70 cubic feet in the same time, showing a saving of about 25 per cent. A double furnace costs about £350.

The operations in these furnaces begin at three or four o'clock in the morning, after the muffles have been put in order on the previous day, by a removal of the residues and a new charging. The operations are begun thus early, in order that the chief distillation may be controlled during the day, and also for the comfort of the workmen in the hot season. The zinc is then removed from the adapters, and from 36 to 40 lbs. of ore are added to each of the muffles through the adapters without removing the residues, the clay plugs are fixed, and the other side of the furnace operated on. The muffles are here charged in the usual way with from 74 to 80 lbs. of ore, previously removing the residues, and the distillation commences. These manipulations are finished in about four or five hours if no repairs or changing of muffles, &c., are required. This mode of carrying on the process differs from the common Silesian mode, in which one side of the furnace is charged anew every 48 hours, (which seems irrational, as  $\frac{1}{3}$ rd of the mixture remains in the furnace only half the time), but no better mode with regard to large production is at present known.

A strong flame appears soon after charging; it is associated with zinc vapour, and diminishes after about two hours. An hour later the distillation of liquid zinc commences. The liquid zinc is removed from the adapters in the evening and again the following morning.

At the beginning of the distillation a gentle heat is given to prevent the formation of too much zinc dust, which is collected in the receivers as the adapters are still too cold. But a high uniform temperature, depending on the resistance of the distilling vessels to fusibility, is then kept up, and that of the adapters is regulated by the before-mentioned doors.



The adapters must also be frequently cleared, chiefly at the commencement of the operation, when the formation of zinc dust is abundant.

The smaller furnaces are attended by two, and the larger by four workmen ; there are also two assistants to every two furnaces, their business being to keep up the fire, and one assistant to every four or five furnaces to keep the adapters free from zinc dust.

#### Illustrations of the above Described Process.

At Valentin Cocq and Flone,\* in Belgium, calamine from Moresnet and Spain is worked under favourable circumstances. 1 ton of coal costs 7s. 9d., 1 ton of Belgian clay about 12s. 3d., a muffle 3s. 10d., an adapter 27d., and 1 ton of fire-bricks £1 9s., or £1 4s., according to quality. In 12 hours one workman makes 3 muffles, or from 25 to 30 adapters, and receives 10½d. for each muffle, and about 9d. for one dozen adapters. About 38 per cent of zinc is produced from calamine containing 50 per cent. The cost of producing 200 lbs. of zinc is about 9s. 10½d. ; namely, 5s. 9d. for coal, 3s. 3d. for labour, 6d. for muffles, and 4½d. for other refractory materials, and cast and wrought iron.

At Berge-Borbeck,† 1 ton of Belgian clay costs £1 5s. 7d., 1 ton of Rhenish clay 11s. 8d., and of coal 11s. 1d. The roasted blende, containing from 48 to 50 per cent of zinc, is worked together with calamine containing from 25 to 30 per cent of zinc, and the yield amounts to 35 or 37 per cent of zinc. The cost for producing 200 lbs. of zinc amounts to 13s. 11d., which is about 4s. more than in Belgium.

In 1861, 3,423 tons 8 cwts. of zinc were produced from 8,770 tons 11 cwts. of roasted ores, consuming 23,911 tons of coal ; 270 workmen and 20 reducing furnaces were employed. 6 roasting furnaces produced 4,018 tons of roasted ores, while consuming 1,347 tons of coal.

\* B. u. h. Ztg., 1860, p. 31.

† Ibid., 1860, p. 97 ; 1861, p. 390.

**THE OLD ENGLISH PROCESS FOR REDUCING ZINC.**

This process is almost obsolete, but it is still in use at the Zinc Works,\* near Neath, where it is employed for the re-distillation of zinc scraps and other waste; but not for the treatment of ores.

In this process the distillation takes place in closed crucibles; the volatilised zinc is made to pass through an orifice at the bottom of the crucibles, and into a vertical iron tube, where the vapours of zinc condense and drop into a vessel standing beneath. The crucibles last a long time, and the consumption of clay is therefore very small; but, on the other hand, a considerable consumption of coal takes place. Whilst in the Belgian process 1 part of zinc requires from 6 to 8 parts of bituminous coal for its production, in the Silesian process from 15 to 20 parts of non-caking coal, and in the Belgian-Silesian process about 7 parts of bituminous coal; in the old English process from 24 to 27 parts of bituminous coal are required, and rich residues are formed, whose removal is troublesome, and the production is comparatively small.

The furnaces† used are sometimes rectangular and sometimes round; round furnaces being preferable. They are mounted with from 6 to 8 crucibles or pots (*vide* Fig. 131), arched over with a cupola (*a*), placed under a conical chimney (*b*), which serves to give a strong draught and to carry off the smoke. In this cone there are as many doors (*c, c, c*) as there are pots on the furnace, and an equal number of vents (*d, d, d*) in the cupola, through which the smoke may escape, and the pots may be set. In the surrounding wall there are holes for removing any pots which may have become unserviceable; after the pots are set, these holes are bricked up. Before being set, the pots are heated to ignition in a reverberatory furnace, and are put in by means of iron tongs supported upon two wheels, like those used for glass-house pots. *e*, is the grate; *f*, the door for fuel; *g*, the ash-pit. The pots (*h, h, h*) have holes in the centre of

\* B. u. h. Ztg., 1861, p. 430.

† Dr. URE's Dictionary of Arts, &c., iii., 1126.

FIG. 131.

www.libtool.com.cn

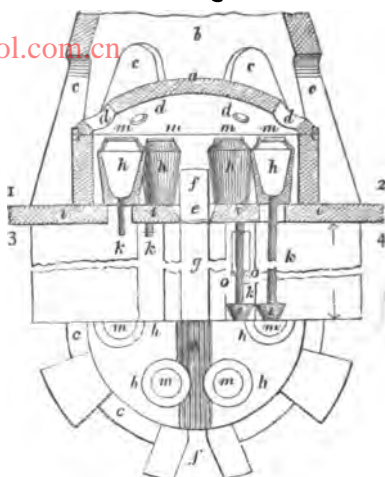

FIG. 132.

their bottom, which are closed with wooden plugs, when they are set, charged with ore mixed with coal, to prevent the mixture from falling through the orifice; when the heat rises the plugs are consumed. The sole of the hearth (*i, i*) upon which the crucibles stand is perforated under each of them, so that they can be reached from below; when the distillation begins, a long sheet iron pipe (*k*) is joined to the bottom orifice of the pots, and the end of the pipe dips into a vessel (*l*) for receiving the drops of condensed zinc. The pot is charged from above, through an orifice in the lid, which is left open after the firing until the bluish colour of the flame indicates the volatilisation of the metal, when the hole is immediately covered with a fire tile (*m*). The iron tubes are liable to become obstructed during the distillation, and must therefore be occasionally cleared by means of an iron bar. 1, 2 is the level of the upper floor; 3, 4 the level of the lower ceiling of the lower floor.

Fig. 132 is the ground plan on the level of 1, 2, and only one half is shown.

The crucibles are charged in the following manner:—A vessel full of coke is put on the bottom of the crucible, on that a vessel full of small coke, upon which four vessels full

of roasted blende are charged, and again four vessels full of coke ; the crucible is thus filled by alternate layers, and contains six vessels full of coarse coke, one vessel of small coke, and four vessels of blende. Six crucibles of a furnace contain 1 ton of roasted ore, and yield from 6 to 8 cwts. of zinc. After the lid is fixed and luted the firing begins, and a brown flame soon appears at the orifice at the bottom. As soon as this flame assumes a bluish-white hue, the iron tube is fixed to the crucible, and the condensed zinc then drops into the vessel; any flame at the end of the tube must be extinguished.

In about 67 hours, when no more zinc is produced, the process is finished. The lid and tubes are then removed, the residues taken out, and the furnace charged afresh. The resulting raw zinc is re-melted in iron pots, skimmed, and poured into moulds.

The production of 1 ton of zinc costs £22; namely, for coal £7, for labour £5 5s., for clay, bricks, &c. £1, for 3 tons of blende from £2 15s. to £3 5s. At Stourbridge 1 ton of clay costs from 11 to 12s.

The Belgian process has been adopted at most of the zinc works in South Wales, and the Belgian-Silesian method in some cases. In 1860, 15,552 tons of zinc blende of Cornwall, Derbyshire, Cardiganshire, North Wales, Ireland, and of the Isle of Man, were worked, with a yield of 28 per cent of zinc, besides 4,368 tons of ore from Sweden, France, and Spain; 3,434 tons of calamine, containing from 64 to 68 per cent of zinc, were imported from Spain.

In 1860, 4,422 tons of zinc were produced in England, 29,215 tons imported, and 7,797 tons exported.

In 1865, the imports amounted to 30,685 tons of zinc, 5,158 tons of ore of zinc, and to 1,506 tons of oxide of zinc.

#### Extraction of Zinc in Cupola and Reverberatory Furnaces.

All the processes already described for extracting zinc possess one or two disadvantages in various degrees, *i.e.*, a great consumption of fuel and fire-clay, and great expenses for labour, owing to the long time required for distillation. Many trials have been made with the object of simplifying the

processes, and to improve them by applying cupola and reverberatory furnaces, and many other apparatus of different construction. Experiments with reverberatory furnaces have not proved successful, owing to the inclination of zinc vapour to oxidise on coming into contact with atmospheric air, steam, and carbonic acid, and also on account of the great volatility of the metal.

In the trials with cupola furnaces much oxide of zinc and very little zinc were always produced, the oxide then requiring the usual treatment in retorts. It has already been mentioned that cupola furnaces are employed for the production of rich material for the distillation process, formerly by Duclos de Bussois\* and Normandy,† and lately by F. Thum.

At Lancaster,‡ in Pennsylvania, oxide of zinc is produced by treating roasted blende with coal in reverberatory furnaces.

#### Illustrations of the above-described Processes.

At the smelting works of the Upper Hartz|| roasted blende has been worked in a cupola furnace 16 feet high, and of the form of an iron blast furnace. The fuel was charged together with the blende, which was expected to produce zinc vapour; on entering the hot part of the furnace, the furnace being heated with a hot blast, it was further anticipated that the zinc vapour would pass through openings of the shaft into a space which surrounded the furnace like a mantle, and there become condensed so as to run off as liquid zinc; but oxide of zinc only was obtained.

Hollunder§ and Mentzel,¶ in Upper Silesia, have made similar experiments with the same results.

Broomann's\*\* method has some similarity with the experiments of the Upper Hartz, but the zinc vapour is conducted some height above the boshes of the furnace into channels surrounded with flowing water. This furnace was lately

\* Bgwkd., vi., 377.

† B. u. h. Ztg., 1848, p. 393.

‡ Ibid., 1862, p. 264.

|| Ibid., 1853, p. 33.

§ KARST., Arch., xiii., 392.

¶ LAMP., Fortschr., 1839, p. 248.

\*\* B. u. h. Ztg., 1851, p. 385. Polyt. Centr., 1861, p. 235. Bgwkd., xiv., 612.

improved by being furnished with several tiers of horizontal tubes with their mouths inside the furnace, and communicating on the other side with vertical tubes; this was in order to obtain more control over the draught, and to enable the zinc vapour to condense better. The roasted ore was charged in the furnace with alternate layers of fuel.

The first experiments were made at Jemeppe, in Belgium. A larger apparatus was more recently tried in Königshütte,\* in Upper Silesia, where a ferruginous calamine was treated with the intention of producing zinc and pig iron at the same time; a more or less inferior pig iron resulted, besides oxide of zinc, and more coke was consumed than when producing iron in the usual manner. Experiments at Stolberg† gave equally bad results.

D. Rochaz‡ has constructed a receiver on the top of a blast cupola furnace into which he conducts the zinc by means of two tubes surrounded by flowing water. Ore and fuel are charged sideways into the furnace whilst the air is excluded.

E. Dyar|| has employed a furnace furnished with two shafts, one deeper and wider than the other, and provided with a blast, each communicating with the other by a channel. Carbonic oxide gas is produced in the larger shaft by burning coal or coke, and is conducted into the smaller shaft in order to reduce the zinc ore which is kept there; the formed zinc vapours are conducted into a receiver.

F. Darlington§ decomposes the zinc ore in a cupola or reverberatory furnace by means of lime, iron refinery cinders, &c., and conducts the oxide of zinc formed through heated tubes filled with coal.

A. Accarin¶ charges red hot ore and fuel into a cupola furnace in alternate layers; the furnace mouth is then closed, and provided with a tube for conducting the gases into condensation chambers. The quantity of fuel is lessened

\* B. u. h. Ztg., 1858, p. 187; 1860, p. 395; 1861, p. 428. Polyt. Centr., 1855, pp. 66, 1337.

† Preuss. Ztschr., 1861, Bd. 9, pp., 163, 407.

‡ Dingt., cx., 100. Bgwkfd., xii., 248. Polyt. Centr., 1847, p. 1246.

|| Bgwkfd., ii., 381; v., 9. Polyt. Centr., 1847, p. 1296.

§ Bergeist, 1857, No. 11.

¶ Schles. Wochenschr., 1861, No. 17.

in order to decrease the quantity of the combustion gases and to obtain a more perfect condensation of the zinc.

H. Müller and Lencauchez\* have investigated the conditions under which zinc, as such, can be produced in cupola furnaces. They have constructed a furnace for this purpose. After having been formed into bricks, together with fuel and lime, the ore is charged and then strongly heated. The zinc, in form of vapour and reduced at the level of the boshes where carbonic oxide gas is present, is conducted from the furnace to the receiver, and is condensed in an atmosphere of carbonic oxide gas.

This rather complicated apparatus has given no satisfactory results.

#### TREATMENT OF THE PRODUCTS OF THE REDUCING PROCESSES.

##### a. Re-Melting and Refining the Raw Zinc.

These products are *raw zinc*, *zinc dust*, *deposits*, and *residues*. The zinc resulting from the Belgian and Belgian-Silesian processes is sufficiently pure to be fit for market, but the zinc produced by the Silesian process is always more or less contaminated by oxide of zinc, coal dust, &c., and requires re-melting in iron or clay pots. Some kinds are very impure, and require a calcination in reverberatory furnaces, particularly if they contain much lead.

The pots are sometimes heated by the flame escaping from the reducing furnaces, and sometimes by a separate firing. The iron pots are usually corroded by the zinc after three or four weeks; the zinc becomes ferruginous and assumes a duller bluish lustre which it does not possess when melted in clay pots. But as clay pots are liable to break, iron ones are frequently preferred, as, for instance, at Llansamlet, near Swansea. The pots (*a*) there used are represented by Figs. 133 and 134, and eight cwts. of zinc are melted in them in  $\frac{1}{2}$  or  $\frac{3}{4}$  of an hour. The zinc is stirred from time to time, then allowed to settle for some time, skimmed off by means

\* B. u. h. Ztg., 1861, p. 311. Oesterr. Ztschr., 1861, p. 228 (with drawings).

FIG. 133.

[www.libtool.com.cn](http://www.libtool.com.cn)

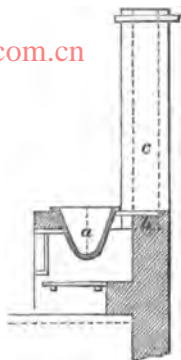
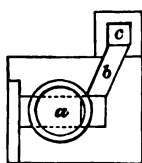

FIG. 134.



of a perforated ladle, and poured into iron moulds, which form it into plates or slabs.

The scum or zinc ash consists chiefly of oxide of zinc and finely divided zinc, and contains most of the foreign substances, except lead. In order to separate this as much as possible, the zinc, after being skimmed, is allowed to cool for about 15 or 20 minutes almost to the point of solidification; the greater part of the lead will then collect on the bottom of the pan. This part of the contents of the pan is kept separate, and if sufficient of this plumbiferous zinc has been collected, it is re-melted and treated in the same manner. It is difficult to regulate the temperature at the re-melting operation, as it must be kept rather high, but must not exceed a certain limit, or a great loss by volatilisation and burning of zinc will take place. Burned zinc (a mixture of zinc and oxide of zinc) is pasty, and, when solidified, less ductile and not easily cut by chisel and file, which is a disadvantage when using zinc for castings. Burned zinc results chiefly when melting zinc in plumbago crucibles with coke firing, and, as it is impossible to purify it cheaply, it is used



as a small addition to good zinc. Miroy\* asserts that the temperature may be fully controlled when re-melting the zinc in iron crucibles heated with coal gas.

Very impure hard zinc, with a greater amount of cadmium, arsenic, lead, &c., is sometimes refined by re-melting in a reverberatory furnace. The zinc is then slowly melted on the sloped hearth of the furnace, and collects in a sump placed on the lower part of the hearth. The zinc ash is skimmed off, and the metal allowed to cool, in order to separate the lead. Cadmium, antimony, and arsenic can only be extracted to a certain degree if the zinc is kept liquid for a longer time.

A furnace employed in Upper Silesia for re-melting zinc intended for rolling is represented by Figs. 135 and 136; *a*,

FIG. 135.

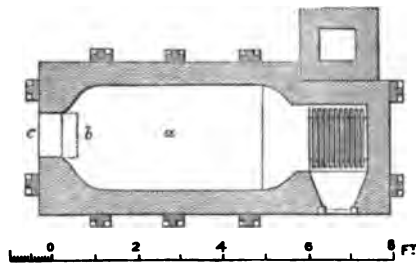
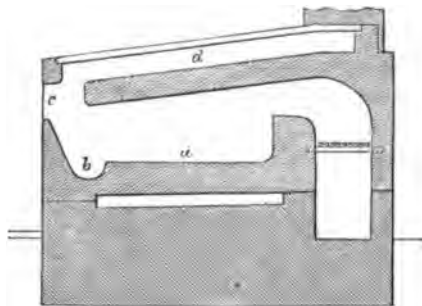

FIG. 136.



is the hearth of refractory material; *b*, the sump; *c*, the working door for charging and ladling out the zinc; *d*, the drying hearth. The raw zinc being divided into pieces is gradually

\* Dingl., Bd., 153, p. 257. B. u. h. Ztg., 1860, p. 52.

charged into the furnace, which has been previously heated, and is slowly melted till the sump is filled; the zinc is then rapidly ladled into iron moulds by means of ladles coated with a mixture of soap and chalk. Most of the so-formed plates keep sufficiently hot to be rolled, and plates which are too cold must be heated in a separate furnace up to the temperature of about 125° C., which is sufficient to keep the zinc ductile during rolling.

The resulting scum or zinc ash is worked up by the reducing process. The temperature at which the zinc is cast has an essential influence upon its nature, *i.e.*, upon its power of resisting acids, water, atmospheric air,\* &c., also upon its behaviour in rolling.

According to Bolley† and Begemann,‡ zinc melted at a very low temperature has a granular fracture, a higher specific gravity, a greater ductility, and is less soluble in dilute acids. Zinc poured out at high temperature, on the other hand, has a laminated crystalline fracture, a lower specific gravity, a greater brittleness, and is easily soluble in acids. At temperatures above 200° C., zinc is brittle; it becomes ductile and fit for rolling and other purposes, when kept at a temperature between 100° and 150° C. The fewer times zinc is heated before its treatment by rollers, &c., the more ductile it will be. The bending of a rolled zinc plate does not make any noise, but a crepitating noise will be observed after having heated the plate, probably due to a rearrangement of the crystals that have been formed by the influence of the temperature. Zinc which has been heated almost red hot shows a laminated texture if it be rapidly cooled, and zinc heated nearly to its melting point has a fine granulated texture if slowly cooled; the specific gravities are likewise modified.

The presence of certain impurities renders zinc harder.

Karsten states that carbon has no influence on the nature of zinc. Taylor, Eliot, and Storer have discovered sulphur

\* Polyt. Centr., 1857, p. 1852.

† Polyt. Centr., 1856, p. 1398. ERDM., J. f. pr. Chem., Bd. 66, p. 451.

‡ Dingl., Bd. 142, p. 100.

in many kinds of zinc, chiefly in those produced from blende. A certain amount of sulphur seems to facilitate the combination of zinc with iron, in case the zinc is kept fluid for a longer time in iron pots, or is in contact with iron tools. Zinc-white produced from such zinc shows fine rose or cherry-red spots of oxidised iron. Schäuffele\* discovered arsenic in zinc, a small amount of which renders zinc brittle. According to Cooke, the arsenic promotes its crystallisation; antimony has a similar behaviour.

Tin is seldom found in zinc; one per cent renders zinc unfit for rolling at the required temperature;  $\frac{1}{2}$  per cent of copper renders zinc so hard that it is difficult to roll, and yields very brittle plates.

A large amount of cadmium renders zinc brittle and of a fine granular texture. Mentzel states that zinc with from 5 to 15 per cent of cadmium may be rolled into plates one line thick, without cracking. As both metals can only be separated by repeated distillations, in which cadmium first volatilises, and as this causes a great loss, experiments have been tried at the zinc works at Birkengang,† near Stolberg, to work zinc with from three to eight per cent of cadmium by the wet way, which is based upon the fact that when treating mixtures of zinc, cadmium, and lead with acids, the zinc first becomes dissolved, and the cadmium which may be in solution, as well as the lead, are again precipitated by zinc. The latter may then be precipitated by lime as fine white oxide of zinc, whilst the residue of cadmium and lead may be distilled, yielding cadmium.

Iron is frequently contained in zinc, and the presence of 0·13 or 0·14 per cent does not, according to Karsten, greatly influence its quality, but an amount of above 0·2 per cent renders it harder, and necessitates a careful stronger heating for the purpose of rolling. If lead be present at the same time, iron is more injurious. Its presence may be detected by grey spots on the fresh surface of zinc. Eliot and Storer found from 0·05 to 0·21 per cent of iron in zinc; Karsten

\* Dingl., Bd. 116, p. 248.

† B. u. h. Ztg., 1862, p. 307.

found 0·24 per cent, and Percy 1·64 per cent. Iron may be separated from zinc by distilling in clay vessels.

Lead is found in zinc still more frequently than iron, and injures its firmness. According to Karsten, all zinc contains traces of lead, usually from 0·3 to 3 per cent. When containing  $1\frac{1}{2}$  per cent it may still be rolled, but yields soft plates. A greater amount causes it to crack. If lead and zinc are melted together, they separate again according to their specific gravities, but the lead always retains some zinc, and the zinc some lead. Matthiessen and Rose state these amounts to be respectively 1·6 and 1·2 per cent. Bismuth behaves like lead; when bismuth and zinc are melted together and separated again, bismuth will retain from 9 to 14 per cent of zinc, and zinc 2·4 per cent of bismuth.

When choosing zinc for different uses, these foreign admixtures must be taken into consideration as well as the already mentioned influence of the temperature upon castings and rolled plates. The presence of foreign substances, chiefly arsenic, iron, and lead, and the temperature, are of most importance when rolling the zinc. In casting zinc, the chief consideration is the temperature, which must be so regulated as to avoid the formation of burned zinc. A greater amount of lead, cadmium, sulphur, and iron is deleterious to the manufacture of zinc-white, the lead giving a reddish, and the iron a yellowish hue. Rolled zinc used for coating vessels and buildings, &c., must be as free as possible from iron and lead, as the smallest amount of these substances facilitates the corroding of the metal by galvanic action.

#### b. Reduction of the Zinc Dust.

Zinc dust is a mixture of very finely divided metallic zinc, with eight or ten per cent of oxide of zinc, and contains the volatile metals, such as arsenic, cadmium, &c., which existed in the zinc ore, and sometimes also the chlorides, iodides, and bromides originating from the coal used for reducing the oxide of zinc. As the zinc dust collected in the receivers frequently amounts to 9 or 10 per cent of the whole production, the working it up is very important, especially in zinc works where blende and impure calamine are treated.

According to Thum,\* zinc dust of Borbeck contains 97·82 per cent of zinc, 0·16 per cent of iron, 0·23 per cent of lead, and 0·08 per cent of cadmium and arsenic; zinc dust of Birkengang† contains from 9 to 12 per cent of cadmium.

The most common way of working it up, is by adding it to the mixture in the distillation vessels. Although the impurities of the zinc dust are thus again added to the ores, the admixture is in such proportions that the quality of the resulting zinc is little affected. In the Belgian process the zinc dust mixed up with ore and coal is worked in the uppermost tier of retorts, which are only discharged every 24 hours; by this process the zinc dust yields about 80 per cent of zinc.

In some few cases the zinc dust is worked up in separate furnaces constructed for the purpose by Montefiore.‡ This furnace consists of a number of vertical tubes into which clay cylinders fixed to iron rods are fitted. The zinc dust is put into the tubes, which are then heated to the melting point of zinc; the cylinder is now pressed upon the zinc dust, separating the melted zinc, which is then tapped off. In this way about 90 per cent of zinc is extracted from the zinc dust, but as this zinc contains all the foreign substances of the zinc ore, it is of very inferior quality, and unfit either for the purpose of rolling or the manufacture of zinc-white; wherefore this mode of working up the zinc dust is only used in zinc works where, as at Bleiberg, the zinc resulting from the ores is so hard as to require refining in reverberatory furnaces; the zinc produced from the zinc dust is then added to the refining process. From 14 to 18 cwts. of zinc dust may be worked up in 12 hours by 12 cylinders, consuming from 11 to 14 cubic feet of coal.

The deposits formed in the adapters are worked up in the distillation process. The residues of the reducing vessels contain from 2 to 9 per cent of zinc, or even more, and are mostly thrown aside, but are sometimes submitted to a hand

\* B. u. h. Ztg., 1859, p. 409.

† Ibid., 1862, p. 307.

‡ Ibid., 1859, p. 409; 1860, p. 29. Revue Univers., 2 Jahrb., 1 Lief., 1858.

sorting; if they are the result of working argentiferous and plumbiferous blende, it may be profitable to wash them.

In 1859, the production of zinc in Europe amounted to the following:—

In Silesia . . . . .	39,000 tons.
By the Vieille Montagne Company	27,000 „
„ other Rhenish Companies .	11,000 „
„ other Belgian „ . . .	9,500 „
In Great Britain . . . . .	7,500 „
„ Spain . . . . .	1,500 „
„ Polonia . . . . .	1,500 „
„ Austria . . . . .	750 „
„ France . . . . .	500 „

Total . . . 98,250 tons.

In Dr. Ure's Dictionary, iii., 1127, the general consumption of zinc throughout the world is estimated to be 67,000 tons per annum, of which about 44,000 tons take the shape of rolled sheets; they are employed as follows, each quantity being rather below the fact:—

Roofing and architectural purposes . . . . .	23,000 tons.
Ship sheathing . . . . .	3,500 „
Lining packing cases . . . . .	2,500 „
Domestic utensils . . . . .	12,000 „
Ornaments . . . . .	1,500 „
Miscellaneous . . . . .	1,500 „

Total . . . 44,000 „

Fifteen years ago the quantity used for roofing did not exceed 5,000 tons; none was employed for ship sheathing, or lining packing cases, and stamped ornaments in zinc only date from 1852.

## CHAPTER IV.

### CADMIUM.

CADMIUM is frequently associated with zinc ores, calamine as well as blende; Silesian calamine contains as much as 5 per cent, and sometimes more; Wiesloch calamine above 2 per cent, the blende of the Upper Hartz from 0·36 to 0·79 per cent, blende of Przibram 1·78 per cent, and that of Eaton, in North America, 3·2 per cent. The cadmium contained in these ores becomes concentrated in the yellowish brown smoke which is abundantly given off at the commencement of the distillation of zinc; this smoke consists of oxides and carbonates of zinc and cadmium, and is used as a material from which the cadmium is extracted. Sometimes it is also produced from the zinciferous fume (*cadmia fornacum*) of the smelting furnaces.

The production of cadmium from zinc ores is therefore divided into two periods—namely, the production of the smoke, and its reduction in suitable vessels, the cadmium being thus distilled. The separation of cadmium from zinc is based upon the greater volatility of cadmium; for while zinc can be distilled only at a white heat, cadmium volatilises at 360° C., which is only the fusing point of zinc. As soon as cadmium comes into contact with atmospheric air, by escaping from the distilling vessels, it oxidises, forming a brownish yellow oxide mixed with oxide of zinc.

If intended for the production of cadmium, the smoke employed for this purpose is that deposited in the receivers, during the first four hours of an operation; before distilling, it is frequently submitted to a concentration.

Experiments have been lately made to separate cadmium from zinc and zinc dust by the wet way (page 464).

Cadmium is produced on a large scale in some of the zinc works of Upper Silesia.\*

In this instance the brownish yellow smoke is heated for the purpose of concentration in a common zinc muffle, but in a separate furnace, sustaining a moderate temperature. Instead of the clay adapter, the muffle is provided with a conical iron tube, wherein the reduced zinc condenses in drops, whilst the cadmium which remains in the form of gas is deposited as a brown oxide in the lower part of the iron tube; and this tube is closed with a perforated wooden plug, which allows the gases to escape, but retains the cadmium.

The charge for one muffle is a mixture of 1 cwt. of raw oxide, and 0.33 cubic metre of small coke, which is heated just up to a red heat; every 12 hours a new mixture is charged, and the residues of three mixtures are removed together. The brown oxide collected in the iron tube and the zinc are from time to time removed.

The reduction of concentrated oxide of cadmium is effected by means of charcoal in a small cylindrical cast-iron retort furnished with a conical iron plate adapter, which is closed with a pierced wooden plug.

The retort is heated by the waste flame of the calcining furnaces, and charged each time with four handfuls of mixture; in 12 hours a new mixture is charged, and the residues of three mixtures removed together. The cadmium collected in the iron adapter is remelted and cast into small cylindrical bars. Four muffles for concentrating the oxide yield from 1.4 to 1.5 lb. of cadmium; 201½ lbs. of cadmium,

\* ERDM. Journ. f. ök. Chem., i., 342. KARST. Arch., 2 R., i., 411. Ann. d. min., 4 sér., ii., 31. Bgwkd. vii., 217.



saleable at 6s. a pound, were produced at Lydogniahütte, in 1860. Cadmium was formerly produced in this country.\*

This metal is used in laboratories, and for painting purposes, and latterly for the production of an alloy called Wood's metal,† consisting of 2 parts cadmium, 2 parts antimony, 4 parts lead, and 8 parts bismuth, which is easier to fuse than the alloys of Rose and Newton. Its fusing point is between 65° and 71° C. On the whole, the utility of cadmium is very limited.

\* KARST. Arch., 1 R., vi., 424.

† DINGL., Bd. 1158, p. 271. B. u. h. Ztg., 1861, p. 380.

## CHAPTER V.

### TIN.

#### PRINCIPAL TIN ORES.\*

**Tin stone, Cassiterite**, the peroxide,  $\text{SnO}$ , with 78·6 per cent of tin, is the only tin ore found in sufficient abundance for metallurgical purposes. It occurs disseminated in granite, gneiss, clay slate, chlorite and mica-slate; also in beds and veins, in large irregular masses, and in pebbles, in the beds of ancient torrents; the ore occasionally takes a ligneous aspect, and is then termed **Wood Tin**. It is usually associated with tungsten, molybdenum, arsenical iron, and copper pyrites, magnetic iron ore, blende, copper glance, native bismuth, antimonial ores, quartz, fluor spar, apatite, and other minerals. It is found in but few countries in sufficient quantity to be workable. It is found chiefly in Cornwall, Saxony, and Bohemia in Europe; in Malacca, Banca, and Billitan in Asia; in Bolivia, Mexico, and Chili, and in small quantities in Spain and France.

It is sometimes associated with sulphide of tin, **Stannine**,  $\text{Cu}_2\text{S}$ ,  $\text{SnS}_2 + 2(\text{FeS}, \text{ZnS}) \text{SnS}_2$ , containing 29 per cent of tin, and 29 per cent of copper.

\* B. u. h. Ztg., 1842, pp. 97, 1001; 1844, p. 3; 1861, p. 1; 1862, pp. 144, 415. Ann. d. min., 3 sér., xx., 65. Bgwkfd., v., 352; iii., 352, xvii., 274. Berggeist, 1861, Nos. 38, 43, 83. DECHEN, Statist. d. Zollv. Deutchl., i., 772. Jahrb. d. k. k. Geol. Reichanst., 1853, p. 190. KARST. Arch., 1 R., xiii. Oesterr. Ztschr., 1862, No. 26.

The Cornish ores\* occur:—1, in *small strata* or *veins*, or in *masses*; 2, in *congeries of small veins*; 3, in *large veins*; and 4, *disseminated in alluvial deposits*.

The **Stanniferous Small Veins**, or thin flattened masses, though of small extent, sometimes numerous interspersed in certain rocks, parallel to their beds, are commonly called **Tin Floors**. In the mine of Bottalack, a tin floor thirty-six fathoms below the level of the sea, has been found in the *Killas* (a shistose rock); it is about a foot and a half thick, and occupies the space between a principal vein and its ramifications; but there seems to be no connection between the floor and the great vein.

The **Disseminated Masses**, or *Stockwerks*, as the Germans term them, occur in granite, and in the felspar porphyry, called in Cornwall *elvan*. The most remarkable of these occur at the tin mine of Carclase, in the granite near St. Austell. The works are carried on in the open air, in a friable granite, containing felspar and kaolin, or china clay, which is traversed by a great many small veins, composed of tourmaline, quartz, and a little tin stone, which forms black markings on the face of the light grey granite; these little veins rarely exceed six inches in thickness, including the adhering solidified granite, and are occasionally much less. Some of them run nearly due east and west, with an almost vertical dip; others in the same direction, incline to the south at an angle of 70°.

**Stanniferous Masses** are much more frequent in the *elvan* (porphyry), the mine of Trewidden being a remarkable example of this. It is worked among flattened masses of *elvan*, separated by strata of *killas*, which dip E. N. E. at a considerable angle. The tin ore is in small veins, varying in thickness from half an inch to eight or nine inches, and occurring so irregularly, and interruptedly, that it is difficult to determine their direction and inclination.

The **Large Metalliferous Veins** are not equally distributed over the surface of Cornwall and the adjoining parts of Devonshire, but are grouped into three districts;

\* Dr. URE'S Dictionary of Arts, iii., 906.

namely, 1, the south west of Cornwall, beyond Truro; 2, the neighbourhood of St. Austell; and 3, the neighbourhood of Dartmoor, in Devonshire.

The first group is by far the richest and the best explored. The formation most abundant in tin mines is principally granite, though there are numerous exceptions to this. The most ancient metalliferous veins are the great tin veins in Cornwall; yet these are not of one formation, but belong to two or more different systems. Their direction is, however, nearly the same, but some of them dip towards the north, and others towards the south. The Cornish miners were formerly of opinion that tin occurred in the upper portions of the mineral lodes only, and mines were abandoned when in sinking, the miners came to the yellow copper pyrites, which were said to have *cut out* the tin. Within the last few years, however, tin has been found at very great depths below the surface and beneath the copper. Dolcoath mine is a remarkable example of this. This mine was worked first as a tin mine for a very long period; then as a copper mine for half a century; and finally, on exploring still deeper, the lode was found to become richer in tin, and is now worked to great advantage.

**Alluvial Tin Ore, Stream Tin.**—Peroxide of tin occurs disseminated both in the alluvium which covers the gentle slopes of the hills adjoining the rich tin mines, and in the alluvium which fills the valleys that wind round their base; and in these deposits the tin stone has been so abundant, that for centuries the whole of the Cornish tin was derived from them, and still is to some extent. The most important explorations of alluvial tin ore are grouped in the environs of St. Just and St. Austell, where they are called *stream works*, because water is the chief agent employed to separate the metallic oxide from the sand and gravel.

#### **Synopsis of Processes for the Extraction of Tin from its Ores.**

The object of these processes is to reduce, at a suitable temperature, the oxide of tin contained in the tin ore, and to transform the earthy and metallic foreign associates into a slag as

thin as possible, so as to allow a thorough separation of the reduced particles of tin; though simple in themselves, these operations are rendered more or less imperfect by the following circumstances:—

**1. Certain Properties of the Oxide of Tin.**—This requires for its reduction a very strong red heat, approaching to whiteness, at which most of the foreign metallic oxides, which are frequently associated with tin ore, are also reduced, many of them, indeed, at a much lower temperature. These reduced metals combine with the tin and impair its quality, or they form deposits on the hearth of the furnace, and injure the process. Again, as tin oxidises so easily, oxide of tin is formed at the high temperature required for reduction, and this oxide becomes partly scorified, and is partially carried away mechanically owing to its fine division. The cupola furnaces must therefore be so constructed as to allow a quick reduction of the oxide of tin, and to remove the reduced tin as quickly as possible from the space where the blast reacts. Furthermore, as oxide of tin combines as a base with silica, and also, though less markedly, as an acid with oxide of iron, manganese, lime, &c., its tendency to scorification is very great, forming combinations from which the tin may be partly extracted only at a high temperature, when the foreign metallic oxides present (chiefly oxide of iron), are also reduced in larger quantities.

**2. The Quality and Quantity of the Earthy Associates.**—As tin ore occurs in older formations which are rich in silica, and therefore difficult to fuse, the formation of slag is rendered difficult. If ferruginous fluxes are added to facilitate the fusibility, a great deal of iron will become reduced, and some oxide of tin scorified by the protoxide of iron. An addition of lime acts similarly with regard to the scorification of tin; the least of two evils is therefore chosen, and the formation of a slag rich in silica (bisilicate) preferred. This slag being pasty and difficult to fuse, retains many grains of tin, the extraction of which necessitates a re-smelting or a dressing. When dressing, the scorified oxide of the tin is considered as lost.

**3. The Quality of the Metallic Associates.**—These are present either in an oxidised state, as magnetic iron ore, tungsten; in a sulphuretted state, as iron and copper pyrites, galena, copper glance; in a metallic state, as bismuth, copper; or in combination with arsenic, as arsenical pyrites. They are partly scorified by the smelting process, and partly decomposed, alloying the tin, such as iron, copper, bismuth, lead, arsenic, tungsten, &c.; or are volatilised, and form in the furnace deposits which injure the process. As these metallic associates have nearly the same specific gravity as tin ore, and as the tin ore usually occurs finely disseminated in gangue, it cannot be sufficiently separated by a mechanical dressing; they are, therefore, partially separated by combined roasting and washing processes previous to the smelting. Tungsten has to be separated by a special smelting process; if it remains in the ore, part of the tungstic acid combines with protoxide of iron and manganese, and enters the slags, but another part becomes reduced and alloys with the tin.

The processes for the extraction of tin may therefore be classified into certain preliminary operations, into the reduction smelting in cupola or reverberatory furnaces, and into the further treatment of the smelted products.

#### I. PREPARATION OF TIN ORES.

A mere mechanical preparation is only sufficient for stream tin and a few kinds of mine tin, such as the ore from Carclase, Wheel Bal, and Irtendron, in Cornwall.

In most cases a farther chemical treatment is required to extract the foreign admixtures. The following operations may be adopted:—*a.* A soft burning of the fragments of ore. *b.* A mechanical dressing of the raw or burned ore. *c.* A roasting of the schlich resulting from the latter operation. *d.* Subsequent washing. *e.* A treatment of the roasted mass with acids or with sulphate of sodium for extracting tungsten.

*a. Soft Burning of the Ore previous to its Dressing.*—The tin ore of Altenberg, in Saxony, containing  $\frac{1}{3}$  or  $\frac{1}{2}$  per cent of tin and the before-mentioned associated minerals, and of great compactness, is burned in open heaps. Upon a layer of ore 0·3 metre thick and 12 metres square, a layer

of wood shavings 0·1 metre thick is placed, and upon these a layer 0·7 metre thick of brush-wood; next comes a layer 1·5 metre thick, of ore in grains the size of two cubic decimetres, and the side walls are also furnished with layers of this ore one metre thick; the whole is then covered with a layer, 0·3 metre thick, of the ore of the size of the fist; the heap burns two days.

If mounds are used, they are furnished with a foundation of wood 14 or 16 inches thick, upon which a layer of tin ore  $2\frac{1}{2}$  to 3 feet thick is placed, and covered with small coal 4 or 5 inches thick.

In England roasting furnaces are employed for this burning, the ores being burned for about six or eight hours.

The object of this partial burning is to save time and expense, nearly three-fourths of the ore being thrown away after dressing from the first burning.

**b. Mechanical Dressing of Tin Ores.\***—The dressing operations vary in different localities, and depend on the quality of the ore, whether it is more or less rich, finely or coarsely disseminated, and on the quantity and quality of the associated minerals. As tin ore is seldom massive, a gigging apparatus cannot be employed, and the tin ore has to be at once stamped more or less fine; but first it is submitted to a hand sorting, which is adopted in Bohemia for separating tungsten, and in Cornwall for separating the pure from the impure ore containing copper and arsenical pyrites and the gangue. The wet dressing of the ore, being rather complicated, causes a considerable loss of metal, amounting in Saxony to about 25 or 30 per cent, and in Cornwall from 17 to 20 per cent.

A comparison of the mining and dressing of the tin ores in Cornwall, Bohemia, Saxony, and the Bretagne, has been made by J. Huguenin, (*Coup d'œil sur la Géologie du Morbihan*: Paris, 1862, page 63).

**c. Roasting the Concentrated Tin Schlich.**—Schlich obtained from pure ores is smelted direct, but that containing

\* B. u. h. Ztg., 1855, pp. 93, 162; 1859, p. 181; 1862, p. 145; 1856, p. 62. Freib. Jahrb., 1830, pp. 217, 235. Berggeist, 1861, No. 68. Preuss. Zeitschr., Bd. 9, p. 251.

pyrites is previously roasted, as it still retains all the tungsten, the greater part of the arsenical pyrites, and much iron and copper pyrites, bismuth glance, together with some native copper and bismuth. The roasting in reverberatory furnaces is resorted to for the volatilisation of sulphur and arsenic, and the formation of oxides which may be washed off, being of less specific gravity than tin ore. The tin ore is but slightly modified by the roasting process; only at the commencement some little sulphide of tin is formed, which afterwards becomes converted into sulphite or sulphate of tin. This may be extracted by muriatic acid, but is lost in the subsequent dressing. In Cornwall the concentrated schlich, which is there called tin-witts, suffers a loss of about 1.5 per cent owing to this circumstance.

At the beginning, the roasting process is carried on at a low temperature, while the mass is continually stirred, in order to avoid caking. The temperature is then increased, and, if required, some coal is admixed in order to decompose the sulphates and arseniates that have been formed in the first period. The coal must not be added if it is intended to collect white arsenic\* in larger quantity, as a by-product in the condensation flues with which the roasting furnace is connected, or when treating ores containing copper pyrites with the intention of lixiviating sulphate of copper from the roasting mass for the production of cement copper. Ores containing iron pyrites only are more easily roasted than ores associated with copper and arsenical pyrites.

FIG. 137.

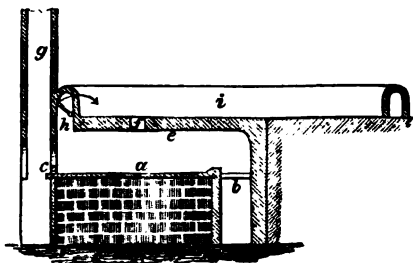

\* TUNNER'S Jahrb., ii., 1852, p. 35.



In Saxony the furnaces connected with condensers for collecting arsenic are constructed as shown by Figs. 137 and 138. *a* is the hearth; *b*, the grate; *c*, working door; *d*, fire-bridge; *e*, furnace roof; *f*, opening for charging the ore to be

FIG. 138.

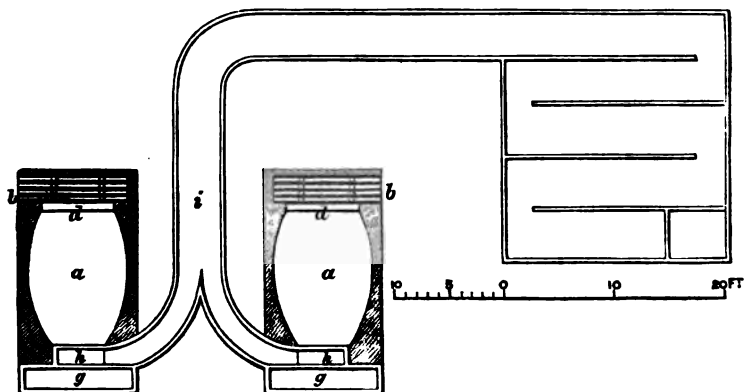

closed by a clay plate when not in use; *g*, chimney; *h*, flue; *i*, channel conducting to the condensation chambers (*k*). The flue *h* is provided with a valve for closing it.

The ore is dried upon the roof of the furnace, and roasted in charges of from 12 to 14 cwts. The temperature and the length of the roasting are regulated according to the nature of the ore; for instance, whilst ores poor in arsenic are first roasted at a low temperature, and also for a shorter time (for about six hours), in order to prevent a caking; ores rich in arsenic are at once roasted at a higher temperature, as more white and less grey arsenic are thus formed. The ore must be continually raked, and the fire gradually lessened, till the ore burns dark and commences to become disintegrated. When smoke ceases to be evolved, coal is mixed with the roasting mass, the temperature is increased, the roasting mass properly stirred, and the sulphates and arseniates will then become reduced. Whilst the valve in the flue (*h*) was before kept open in order to conduct the arsenious acid into the condensation chambers by means of the channel (*i*), it is now closed to prevent any contamination by carbonaceous particles; gases and fume then enter the chimney (*g*). As

the channel is frequently more than 100 feet long, it is provided with several angles to lessen the draught.

A charge of 12 cwts. of schlich rich in arsenic, and containing 2 cwts. of tin, requires from 22 to 24 hours' time for roasting, with a consumption of about 144 cubic feet of wood and a production of 5 or 6 cwts. of white arsenic.

In Cornwall\* furnaces with elliptical hearths of different dimensions are frequently used; for instance, hearths 7 feet long, 4 feet broad at the fire-bridge and 18 inches at the working door, and 5 feet in the middle part. The arched roof is 8 inches above the fire-bridge, 16 inches above the middle of the hearth, and 10 inches above its sides. The grate is 10 inches broad, and lies 11 inches below the fire-bridge.

The charges consist of half a ton of ore or more, which is also dried on the furnace roof, and then spread out on half of the dark red-hot hearth near to the fire-bridge. It is raked every 20 or 30 minutes, and three heaps are thus formed across the hearth; sometimes also a heap is formed alternately length-ways along the hearth. The arsenious acid collects in a channel 2 metres high, 2.5 metres wide, and several hundred metres long, which is provided with partition walls and leads into a chimney. The channel is cleared every one or two months. The ores are either once roasted and then washed, or are roasted again after washing, according to whether they contain only iron and copper pyrites or arsenical pyrites at the same time. In the latter case, the first roasting takes 12 hours, consuming 260 lbs. of coal, and the second from 8 to 10 hours, consuming about 200 lbs. of coal.

According to Dr. Ure's Dictionary of Arts, iii., 910, the machine for calcining tin ore, originally called "Brunton's Patent Calciner," is gradually coming into use in Cornwall, and is adopted in many of the larger smelting works. Its operation may be thus briefly described:—A revolving circular table, usually 8 or 10 feet in diameter, turned by a water wheel, receives through the hopper the tin stuff to be roasted or calcined. The frame of the table is made of cast-iron, with bands or rings of wrought iron, on which rest the fire-bricks

\* B. u. h. Ztg., 1859, p. 319. Preuss. Zeitschr., ix., 253.

composing the surface of the table. The flames from each of the two fire-places pass over the ore as it lies on the table, which revolves slowly, about once in every quarter of an hour. In the top of the dome over the table are fixed three cast-iron frames, called the *spider*, from which depend numerous iron coulters, or teeth, which stir up the tin stuff as it is carried round under them. The coulters on one of the arms of the spider are fixed obliquely so as to turn the ore downwards from one to the other, the last one at the circumference of the table projecting the ore (by this time fully calcined) over the edge into one of the two *wrinkles* beneath. A simple apparatus called the *butterfly*, moved by a handle outside the building, diverts the stream of roasted tin stuff as it falls from the table into either one or the other as may be required. Unlike the operations of roasting in the oven previously described, the calciner requires little or no attention; the only care requisite is that the hopper should be fully supplied, and the roasted ore removed from the wrinkles when necessary.

The burning house and the calciner are represented by Fig. 139.

On page 912 in vol. iii. of Ure's Dictionary will be found the following notes on the action of Brunton's calciners employed at Fabrica la Constanto, Spain, and also the additional suggestions:—

Diameter of revolving bed, 14 feet.

Revolution of bed per hour from three to four, or about 1 foot of the circumference per minute.

Ores introduced by the hopper, at the rate of 1 quintal\* to every revolution of table.

Quantity of ore calcined per day of 10 hours, 30 to 35 quintals.

Salt consumed, generally 6 per cent of the weight of the ore.

Fuel consumed per 10 hours, 1200 to 1400 lbs. of pine wood.

Power employed to revolve table, half horse.

\* 1 Spanish quintal = 46.01 kils. 1 cwt. (English) = 50.8 kils.

FIG. 139.

[www.libtool.com.cn](http://www.libtool.com.cn)

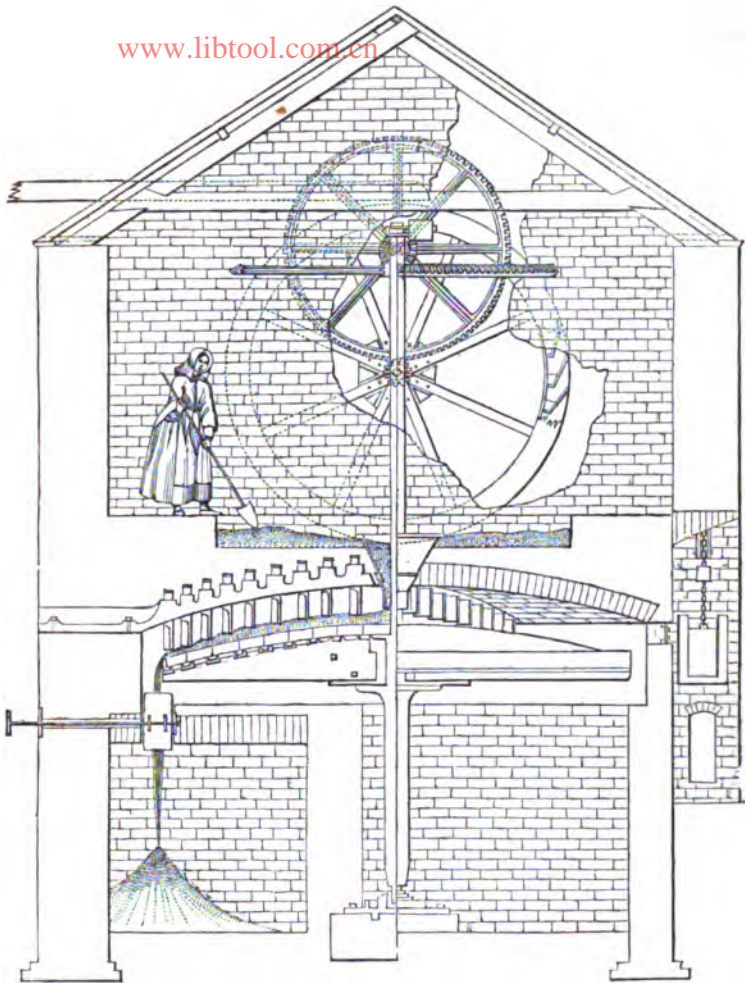

*Remarks.*—The furnace is charged with ore and salt by means of iron hoppers placed immediately over the centre of each of the hearths. A heap of about 14 quintals of ore, with five or six per cent of salt, is prepared for the supply of each hopper, from time to time, upon a small platform on the top of the furnaces, and a few shovelfuls thrown in occasionally as required, taking care, however, always to have

VOL. I.

2 I

enough ore in the hopper to prevent the ascent of acid vapours, &c., from the furnace. The time the mineral remains in the furnace, and the quantity calcined per hour, must depend on the rapidity of motion of the revolving hearth and the angle at which the iron stirrers are fixed.

The average amount passed through each furnace in 24 hours is 84 quintals, or  $3\frac{1}{2}$  quintals per hour; nearly 1 quintal is discharged from the furnace at every revolution of the bed.

This apparatus effects a considerable saving in labour, and allows a good roasting, as on falling upon the middle of the hearth, the ore gradually rises to a higher temperature, and the continual raking causes the formation of less caked particles, and less ore dust is carried away by the gases. Whilst at Altenberg the cost for roasting 1 ton of black tin is £2 5s. 2d., the cost when using a furnace with a revolving hearth is only £1 6s. 4d., namely, 19s. 4d. for coal, and 7s. for labour.

The salt\* which is sometimes added to the roasting mass, serves to volatilise sulphur, arsenic, &c., and to form soluble chloride of copper.

*d. Washing the Roasted Schlich.*—In order to separate some of the oxides and metallic salts formed by the roasting process, the roasted mass is sometimes washed direct, as in Saxony, which concentrates the ore till it contains from 50 to 70 per cent of tin; the resulting schlich is then sometimes smelted as it is, and sometimes previously submitted to a treatment with acids; if the roasted mass contains a larger amount of copper, it is moistened with water or sulphuric acid, exposed for some time to the atmosphere, the caked particles sifted off, and the fine mass mixed in a tub with dilute muriatic or sulphuric acid; the clear cupriforous liquid is then treated in closed vessels with iron for the precipitation of the copper, and the residue is carefully washed.† The resulting schlich (black tin) must sometimes be roasted and washed again in order to concentrate it to a sufficient richness (50 to 75 per cent of tin and upwards).

\* B. u. h. Ztg., 1844, p. 656; 1862, p. 295. Preuss. Ztschr., ix., 254.

† B. u. h. Ztg., 1859, p. 207; 1862, p. 146. Preuss. Ztschr., ix., 254.

In some cases, the particles of proto- and peroxide of iron unremoved by the washing operation are extracted by means of a horse-shoe magnet, thus considerably increasing the value of the ore.

*e. Treatment of the Purified Tin Schlich with Acids.*

—In order to avoid too great loss, the washing of the roasted ores must not be carried too far; hence some foreign oxides, chiefly of iron, copper, and bismuth, and also native bismuth, always remain in the tin ore.

At the Saxony tin works, according to Plattner's suggestion,\* the roasted ore containing bismuth is put into wooden vessels, together with 6 per cent of crude dilute muriatic acid, and stirred for some hours. The dissolved salts are extracted by means of water, and the basic chloride of bismuth thus precipitated is washed out, collected in lumps, and melted in plumbago crucibles, with burned lime and pulverised charcoal, for the reduction of bismuth. This treatment reduces the contaminations of tin schlich from nine-tenths to one-tenth. The Bohemian ores contain but very little bismuth, and are not therefore treated with acids, but are submitted to a sorting by hand to separate the wolfram.

Michell† recommends that common muriatic acid should be diluted with an equal weight of water, and 1 cwt. of this dilute acid used for the purification of 1 ton of schlich. Pearce‡ extracts native copper by dilute sulphuric acid with admission of air, with or without addition of muriatic acid; and he treats roasted ores containing sulphur, arsenical and copper pyrites, as well as grey copper ore, with hot muriatic acid in closed vessels.

Duclos|| introduced into Cornwall the process of treating tin ore with muriatic acid; good results were obtained when treating badly dressed ores, but the process offered no advantages in treating well-dressed ores. The dissolved copper is precipitated either by iron (Levant and Botallack mine) or by soda (Redruth).

\* B. u. h. Ztg., 1852, p. 342, 702.

† Ibid., 1844, p. 656.

‡ Ibid., 1862, p. 263.

|| Ibid., 1862, p. 147.

**Purification of Tin Ores from Wolfram.**—Owing to its great specific gravity, and its refractory nature, wolfram cannot be separated from tin ore by mechanical dressing, by roasting, or by treatment with acids. If present in large quantity it alloys the tin and renders it difficult to fuse. In Cornwall, wolfram is separated by Oxland's\* smelting method, which may be carried out with two modifications; namely, by employing carbonate of soda, or sulphate of soda, both for the purpose of forming soluble tungstate of soda.

At East Pool mine this process is carried on in reverberatory furnaces, furnished with an iron pan instead of a hearth, and so constructed that the flame from the grate passes first over the fire-bridge along the surface of the pan, then across a bridge which lies opposite the fire-bridge, and through flues under the bottom of the pan, into a channel leading into a chimney.

The use of the cast-iron bed effects considerable economy of fuel, and it is admirably adapted for the calcination of raw ores and the evolution of sulphur and arsenic contained in them, but it is especially useful, instead of fire-bricks or tile, by preventing the loss which would result from the reaction of the soda ash on the silica of the brick, giving rise to the formation of double silicate of soda and tin.

According to the fineness of the schlich, charges of from 6 to 9 cwts. of ore are made (the finer the ore the lighter the charges), and from 9 to 12 lbs. of carbonate of soda (containing 48 per cent of alkali) per cwt. of ore, are spread over the heated ore; one or two shovelfuls of coal are thrown upon that part of the hearth opposite the fire-bridge, in order to obtain as uniform a temperature as possible. The mass is kept at a white heat for about six hours; it is stirred every quarter of an hour, and every half hour some coal is thrown upon the back of the hearth. Half the charge is now removed from the furnace, and after one more stirring, the other half. About  $1\frac{1}{2}$  tons of ore, with 330 lbs. of carbonate of soda are treated in four charges, yielding in 24 hours about 10 cwts. of pure tin ore. The mass when heated

\* B. u. h. Ztg., 1852, p. 702; 1862, pp. 194, 294. Preuss. Ztschr., ix., 254.



being in a pasty state, and after cooling frothy, is broken into pieces the size of an egg, mixed with 25 per cent of quartz, and pounded under a stamping mill, the quartz serving to separate the hard alkaline crust from the tin ore. The pounded mass is repeatedly washed, the coarser part pounded two or three times with quartz, and sometimes again treated with soda in the reverberatory furnace. This preparation is comparatively expensive, and it causes a considerable loss of tin ore both mechanically and chemically; the chemical loss arises from the formation of soluble stannate of soda.

When sulphate of soda is used instead of carbonate of soda, the loss of tin is lessened and the process cheapened, but it is rendered more difficult, as the reaction must be alternately oxidising and reducing. The dressed ore is mixed with sulphate of soda, according to the amount of tungsten in it, so that, approximately, tungstate of soda may be formed; some pulverised coal is added, and the mixture heated in a reverberatory furnace by a smoky reducing flame, whilst the mass is continually raked; the sulphuric acid of the sulphate of soda decomposes, and the liberated soda combines with tungstic acid when heated in an oxidising flame. The red-hot mass is removed from the furnace, and after about six hours, when the colour and other qualities of the roasted mass indicate its decomposition, thrown into a cistern full of water. After 24 hours the solution of the tungstate is made to run off through a sieve attached to one of the sides of the cistern; the remaining tin stone is then washed, to remove the peroxide of iron mixed with it which originated from the wolfram. Four charges, equal to 36 cwts. of schlich, are treated in 24 hours, consuming 4 or 5 tons of coal.

The whole of the solution of tungstate of soda is sometimes boiled down, and the crystallised salt used for dyeing purposes, for rendering fabrics non-inflammable, for bleaching linen, for the production of bronze colours, &c.

At Zinnwald, in Bohemia, wolfram is separated mechanically, and sold at about 10s. 6d. per cwt. In 1859, 25½ tons were produced; in 1860, only 5 tons.

At Schlaggenwald (*vide* Preuss. Zeitschr., 1862, Bd. x., Lief.



3, p. 165), 4 or 5 cwts. of ore, with an admixture of common salt, are roasted in a reverberatory furnace for eight hours, at a consumption of 25 cubic feet of coal. The chloride of copper and tungstate of soda thus formed are removed by lixiviation with water, the copper in the solution is precipitated by iron, and tungstate of lime by means of chloride of calcium, and the lixiviated ore is washed again.

## II. SMELTING TIN ORES.

This smelting is effected either in cupola or in reverberatory furnaces, according to the nature of the fuel. Reverberatory furnaces require good and cheap coal, and are exclusively employed in this country; they allow a larger production, a better control of the operations, and give a greater yield than cupola furnaces, as less tin becomes oxidised by the influence of the draught, and as the smelting mass remains longer at a higher temperature, which facilitates the separation of the metal. On the other hand, cupola furnaces yield a better product from impure ores, chiefly those containing arsenic, as the foreign substances are more readily induced to scorify and to volatilise; cupola furnaces also yield more, but do not always give poorer slags than reverberatory furnaces (*vide* Winkler in Freib. Jahrb., 1839, p. 13). Zirkel states in Preuss. Zeitschr., ix., 256, that the production of 1 ton of tin in reverberatory furnaces requires  $1\frac{3}{4}$  tons of coal, and causes a loss of 5 per cent of ore, whilst cupola furnaces consume 3 tons of coal for the same production, and cause a loss of 15 per cent of ore.

The following products result from the smelting of tin ores:—

**1. Crude Tin.**—This contains more or less iron, copper, arsenic, antimony, bismuth, tungsten, molybdenum, &c., all of which substances render the tin hard, difficult to fuse, and more or less pasty when melted. To extract these impurities, the raw tin is submitted to a liquation process, which is effected in German smelting works in open hearths, and in English tin works in reverberatory furnaces. Both methods will be fully described further on.

Refined tin sometimes retains foreign substances, some of them prejudicial to the quality of the tin, even if present in small quantity, whilst others render the tin better fitted for different purposes. Tin is usually impure in proportion to the irregularities and the crystalline character of its surface. Pure tin solidifies, with a smooth, pure, and bright surface, and the characteristic tin-white colour.

Tin is very seldom free from iron, and as little as 0.5 per cent influences its colour and lustre; 1 per cent injures its softness and smoothness, rendering it friable, dark, dull, and showing marks of iron rust, when long exposed to the air. Some sorts of tin, for instance Banca tin, when dissolved in muriatic acid, leave behind a definite alloy,  $\text{FeSn}_2$ , in the form of fine acicular crystals; the same compound is likewise formed on the sole of the furnace in which this quality of tin is smelted, separating out during the slow cooling of the metal.

Small quantities of copper are almost without influence, but tin containing more than 1 per cent becomes harder and less ductile, without, however, losing its lustre. According to Stölzl (*vide* Dingl., Bd. 155, p. 124), an addition of from one-ninth to one-fourth of copper will increase the hardness of tin three- or five-fold. If the addition of copper exceeds a certain limit, it will injure the colour of the tin. The tin foil used in the manufacture of looking-glasses is intentionally alloyed with copper, as the foil then becomes harder, and better able to resist mechanical treatment, and is not too quickly attacked by mercury. According to analyses, tin foil for looking-glasses contains from 0.38 to 2.16 per cent of copper, from 0.04 to 0.84 per cent of lead, and from 0.10 to 0.12 per cent of iron.

Bismuth and antimony in proportions not exceeding 0.5 per cent, without considerably lessening its lustre, impair the ductility of tin in a greater degree than does the presence of iron; they also render the tin crystalline in texture; bismuth increases its fusibility.

Small quantities of lead render tin harder; 1 per cent injures its colour and lustre; the colour, which becomes greenish, may be restored by an addition of nickel.

Arsenic considerably injures the colour, ductility, and lustre of tin, although only 0·5 per cent is present ; if containing more than 1 per cent, the tin is of less specific gravity and white spotted, and after some time it becomes dull and dark coloured.

Zinc renders tin whiter, but also harder and more brittle.

Large quantities of tungsten and molybdenum injure the hardness and strength, and render tin more difficult to fuse.

The presence of sulphur, sometimes occurring in tin reduced in reverberatory furnaces, when coal rich in iron pyrites is employed, renders it friable.

Besides the presence of foreign substances, the temperature employed when ladling the tin into moulds has a considerable influence upon its ductility and lustre. When too strongly heated and presenting an iridescent surface, tin becomes red-short after being cast ; and when heated at too low a temperature, it becomes dull on its surface, cold-short, and less ductile. Such tin is re-melted and poured out at a proper temperature, with a view to improve its quality ; it is of no consequence what addition is employed to cover the melted tin. Tin loses in lustre and colour if it combines with its protoxide while being re-melted.

Manufacturers working tin estimate its quality and value by certain physical properties, such as lustre, colour, texture, surface, ductility, crackling when bent, mobility when flowing, &c.\*

The purest commercial tins are those from Malacca,† Banca, Billitan, and the English tin ; the German is much less pure. The Banca tin, which is the purest and most expensive of all, is in England called *old tin*, whilst that from other parts of India is called *new tin* ; the least pure, but still very good, Indian tin is from Pera. The Banca tin is sold in blocks of 40 and 120 lbs. The Malacca tin comes next with regard to purity, and is about equal in quality to the English grain tin ; it is sold in small truncated four-sided pyramids

\* KERSTEIN, vollständig praktische Anleitung zur Zinnprobirkunst. Quedlinburg.

† The Practical Mechanics' Journal Record of the Great Exhibition, 1862. A, e.

each weighing from  $\frac{1}{2}$  to 1 lb. The English grain tin is sold in blocks 2 feet long, 1 foot broad, and 8 inches thick, and only contains 0.0001 per cent of iron. The refined tin contains about 1-10th per cent of iron, and no arsenic, lead, or copper; the common tin about 1-5th per cent of iron, and up to 1 per cent of copper. The inferior English tins are sold in the form of bars under the name of Japanese tin.

The Saxon tin has improved in quality since its ores have been treated with muriatic acid; it contains only 0.1 per cent of bismuth; Bohemian tin is much less pure, no muriatic acid being used.

Some tin from Pera is equal in quality to English tin, but other kinds contain so much tungsten, arsenic, and lead, as to render them unfit for common use; Phillips\* employs a method for purifying it in the wet way.

The composition of different sorts of tin is shown by the following analyses:—

	Sn.	Fe.	Pb.	Cu.	Bi.	Sb.	As.
1.	99.961	0.019	0.014	0.006	—	—	—
2.	98.64	trace	0.20	0.16	—	—	—
3.	99.5	trace	0.2	—	—	—	—
4.	99.9	—	—	—	0.1	—	—
5.	93.50	0.07	2.76	—	3.76	—	—
6.	—	0.07	1.93	—	2.34	—	—

No. 1, Banca tin, by Mulder; No. 2, English tin, by Berthier; No. 3, French tin, refined; No. 4, tin from Altenberg, by Plattner; No. 5, tin from Pera, by Karsten; No. 6, the same, refined.

**2. Tin Ore Slags.**—These contain tin enclosed partly mechanically, and partly in a scorified state. To extract the tin the slags are repeatedly melted in the ore furnace, or sometimes in a separate smaller furnace; occasionally they are also dressed. Only those slags are thrown away at once which are free from mechanically enclosed tin grains.

Slags obtained in reverberatory furnaces at Poullaouen, from smelting rich and poor ores respectively, were composed as follows, according to analyses by Berthier:—

\* B. u. h. Ztg., 1860, p. 325.

	I.	II.
Silica . . . . .	41'30	40'00
Protoxide of tin . . . . .	9'00	8'40
Protoxide of iron . . . . .	20'50	20'30
Oxide of manganese . . . . .	11'40	11'10
Alumina . . . . .	12'80	9'60
Lime . . . . .	3'90	3'60
Magnesia . . . . .	0'80	1'00
	<hr/>	<hr/>
	99'70	94'00

3. **Deposits formed on the hearth, &c.** If the tin contains iron, and is allowed to remain for longer time in the furnace, these deposits are again added to the slag smelting after being roasted and dressed. According to analyses by Lampadius and Berthier, some deposits from Altenberg contained:—

	I.	II.
Iron . . . . .	61'52	62'60
Tin . . . . .	30'50	31'43
Arsenic . . . . .	1'45	—
Tungsten . . . . .	0'90	1'60
Carbon . . . . .	0'90	—
Silica and Alumina . . . . .	3'51	2'40
	<hr/>	<hr/>
	98'78	90'00

4. **Furnace Ends.**—These usually contain a certain amount of tin, iron, and arsenic, and sometimes also copper, bismuth, tungsten, molybdenum; these are dressed and added to the slag smelting.

5. **Ore Dust** carried away by the blast.—This is washed and added to the slag smelting.

#### REDUCTION OF TIN ORES IN CUPOLA FURNACES.

This mode of treatment is chiefly used for working impure tin ores in Saxony and Bohemia when employing charcoal.

The due admixture of the ores exercises much influence on the result. If judiciously selected, the loss of tin by scorification is greatly lessened, though not completely avoided.

Ores rich in oxide of iron are mixed with quartz; siliceous ores with lime, iron refinery cinders, or ferruginous ores; ores containing wolfram are mixed with lime. If the admixture of lime is excessive much tin will be lost, as it will combine

with lime, whilst too great an addition of quartz renders the mixture difficult to fuse ; ore slags facilitate the process.

An increased temperature at the reduction increases the yield, but also augments the amount of iron in the tin. If ferruginous tin is kept fluid for a longer time, deposits will result.

The process is also influenced by the construction of the smelting furnaces (Karsten's Metallurgy, v., 31). The height of the furnaces is regulated chiefly by the quantity of iron contained in the ores, and by the amount of the production. When treating ores rich in iron in too high furnaces, an abundant formation of iron deposits takes place. In treating smaller quantities of ore by one operation, lower furnaces are employed. The usual height of the furnaces is between 7 and 10 feet.

In order to obtain the high temperature required in the lower part of the furnace, the shaft is made narrow, and somewhat contracted at the lower part. A section of the furnace taken at the level of the tuyere must not contain more than 140, at the highest 220 square inches, whilst a similar section of lead furnaces measures from 1,000 to 2,000 square inches. The greater width of the upper part of the shaft increases the consumption of fuel, but, on the other hand, it lessens the quantity of ore dust carried away ; nevertheless, condensation chambers are required for collecting the ore dust.

The furnaces are usually constructed as channel furnaces, since the reduced tin is at once conducted out of the furnace, protected from the influence of the blast ; for this reason these furnaces are preferred to sump and crucible furnaces, though they do not allow a perfect separation of the smelted masses, and therefore yield richer slags.

#### Illustrations of the Process of Reduction in Cupola Furnaces.

At the smelting works at Altenberg,\* in Saxony, the tin ores containing from  $\frac{1}{3}$  to  $\frac{1}{2}$  per cent of metal are partially

\* KARST., Arch., 1 R., vi., 358. ERDM. Journ. f. ök. u. techn. Chem., ix., 381. Ann. d. min., 1 sér., viii., 499, 837 ; ix., 281, 463, 625 ; 2 sér., iii., 177, 471. Jahrb. f. d. Sächs. B. u. Hm., 1830, pp. 217, 221 ; 1836, p. 119. Bgwkd., xv., 740.

roasted, pounded, dressed by machinery, and washed several times. They are then fully roasted, and ores containing bismuth are treated with muriatic acid; they are afterwards again dressed and washed. The dressed schlich contains from 50 to 60 per cent of tin.

The smelting furnaces employed in Saxony and Bohemia are represented by Figs. 140 and 141. *a* is the rough walling

FIG. 140.

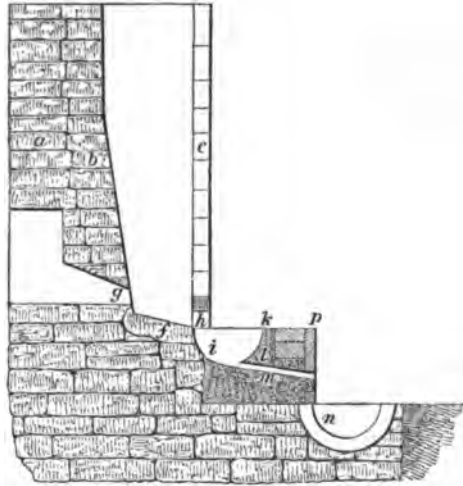
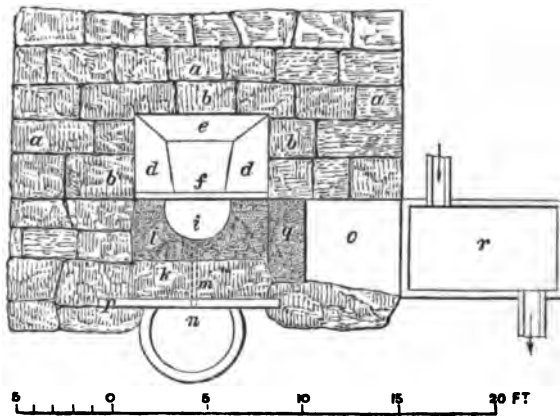

FIG. 141.



of either gneiss or granite; *b, b*, are the casing walls; *c*, the front wall; *d, d*, the counters; *e*, the tuyere wall; *f*, the sole stone, of granite; *g*, the tuyere; *h*, the eye, through which the tin and slag are thrown off into the fore hearth (*i*); *h*, is the fore hearth formed partly of plates of granite and partly of loam; *l, m*, is the channel connecting the basin (*i*) with the stoke hearth (*n*), which is made either of granite coated with loam, or of cast-iron, and furnished with a fire-place beneath; *o*, is a sloping cast-iron plate; *p*, cast-iron plate bordering the fore hearth; *q*, place for the slag to run off; *r*, basin with water for receiving the slags.

The granite sole (*f*) slopes nine centimetres, and the tuyere has an equal inclination. The eye cut in loam is 0·1 metre high, 0·05 metre wide on its lower base, and 0·03 metre on the top. It lies 0·08 metre above the basin (*i*), which is coated with a mixture of small coal and loam; the tin on the basin is thus prevented from oxidising by the flame escaping from the eye.

At the commencement of an operation the fore hearth is first warmed for 24 hours, the furnace is then filled with charcoal, and the blast put in motion. The first charges of tin ore are now made; the tin ore is mixed with ore slags, about  $\frac{1}{2}$  cwt. to 2 cwts. of ore; the mixture is charged by shovelling it on the side walls of the furnace from an elevated platform situated close to the furnace. The soft charcoal, in pieces of  $1\frac{1}{2}$  or 2 cubic inches, is moistened with water previous to putting it into the furnace, so that the schlich will stick to it, and to some degree prevent its being carried away by the blast. The quality of the fuel exerts essential influence upon the process; coke obstructs the furnace and decreases the yield; wood and turf yield only a little impure tin, whilst the cost of smelting is considerably increased. The hot blast entails a greater loss of tin, and the furnaces are injured in a short time. Charges of 50 lbs. of schlich are made every quarter of an hour, and such a quantity of coal is added that the furnace is always nearly full. The process is carried on with the furnace mouth kept dark, sometimes with a short nose, and sometimes without a nose. Each causes loss, the relative amount of which is difficult to



ascertain. If the nose is short, the varying blast caused by common bellows blows oxidised tin out of the eye, and if there is no nose, the oxidised tin is blown out of the mouth of the furnace.

The operation requires experienced workmen ; the progress is judged chiefly by the colour of the tin when flowing from the eye, the shining of the coal before the tuyere, the appearance of the vapour emitted from the eye, and the flowing of the slag. If the process is progressing favourably, the coal will appear of a yellow colour, the tin regularly flowing off will be red, and a light blue vapour will steadily issue from the eye. If the coal is white hot, it shows that the temperature is too high, and necessitates a higher charge of ore ; a dark and thick vapour and a varying colour of tin and coal indicate the contrary. Tin and slags separate in the fore hearth ; these are removed and passed across the iron plate (*o*) into the water basin (*r*) ; the tin is then covered with small coal. The better the slags are, the more readily will they decrepitate in water. If very pure rich schlich is treated, a black stripe of metallic tin appears in the slag gutter, and the fore hearth is rapidly filled with the tin which usually issues at once into the refinery hearth, and is only run off into the outer basin (*n*), when the schlich smelting is finished. If the tin is too hot, it is sometimes ladled from the fore hearth into the outside basin in order to obtain the temperature required for refining. Ferruginous tin forms deposits if allowed to remain longer in the basin. If the schlich has been treated with muriatic acid, such deposits contain very little iron, and are pounded, washed, and returned to the ore smelting.

Owing to want of ore, short operations lasting only three or four days take place. From 30 to 36 cwts. of ore are smelted in 24 hours, producing 15 cwts. of tin, at a consumption of about  $3\frac{1}{2}$  cubic feet of coal to 1 cwt. of ore, and about  $8\frac{1}{2}$  cubic feet to 1 cwt. of tin produced.

According to Lampadius, the total loss of tin by the smelting process in Saxony amounts to 13 or 15 per cent, 8 or 9 per cent of which is volatilised.

The annual production of tin in Saxony amounts to about

150 tons, and in Saxony and Bohemia to about 200 tons, or 1-30th the production in Cornwall.

The resulting raw tin is mostly poured direct from the fore hearth, with ladles, on to the upper end of the refining hearth, situated on the side of the smelting furnace. This hearth is called the *pausch-hearth*, and consists of a ribbed iron plate 1.1 metre long, 0.7 metre broad, and 0.04 metre thick, which is coated with loam and placed at an inclination of  $35^\circ$ , and is warmed and then covered with glowing coal 0.16 metre high. The less easily fusible impurities of the tin remain between the coal, while the purified tin runs along the inclined sole into a sump of cast-iron filled with coal. The tin is repeatedly poured upon the coal from a certain height till it is purified. The coal is then put into a heap, and beaten with wooden hammers till no more tin comes from it, and only small grains of tin remain; these grains are added to the slag smelting.

When the tin has cooled sufficiently to show a bright, bluish surface, it is poured into moulds. The influence of temperature on this operation, and the determination of the right temperature by frequently taking samples, have been already described. When too hot it is sometimes cooled by pouring a portion upon a copper plate, and by putting the chilled pieces back into the metal bath. If it is too cool it is kept covered with glowing coal till hot tin is again added by renewed refining.

When sufficiently cooled, the tin is poured into moulds by means of iron ladles, and thus formed into three sizes, namely, blocks (Banca tin), bars (Japanese tin), and plates (Ball tin). The moulds for Banca tin are 0.125 metre high, 0.34 metre long on the lower part, and 0.46 metre long on the upper part, inclusive of handles 0.04 metre long on the short sides. The mould for forming bars contains six grooves 0.5 metre long, 0.1 metre broad, and 0.005 metre deep, which are filled with tin; the bars are bound into packets, and sold in bundles each containing  $2\frac{1}{2}$  or 5 cwts. Such bars may be bent 74 times before breaking.

In order to form ball tin, it must be poured in a thin stream upon a polished copper plate 1.4 metres long, 0.6 metre

broad, and 0.008 metre thick, thus forming plates about half a metre long,  $1\frac{1}{2}$  decimetres broad, and  $\frac{1}{3}$ rd centimetre thick. Much practice is required to perform this operation well. The tin plates are then rolled together upon an inclined table to form balls or rolls, and are beaten down with wooden hammers, and sold as roll-tin. Before the balls have completely cooled four impressions are made upon them with iron hammers; into these impressions is poured a little fused tin with an addition of grease, and four different stamps are impressed; 18 rolls weigh 1 cwt. The Saxony tin is not much inferior in quality to the English; it contains only 1 per cent of bismuth.

When the slags resulting from the ore smelting process are very impure, they are added to the ore smelting mixture. The other slags are re-smelted by themselves in the ore furnace, requiring more coal and a stronger blast than the ore mixture. The slag thus produced contains fewer grains of tin, and after cooling is re-smelted in a small furnace represented by Fig. 142. *a*, is the vertical front wall with eye (*b*), 0.22

FIG. 142.

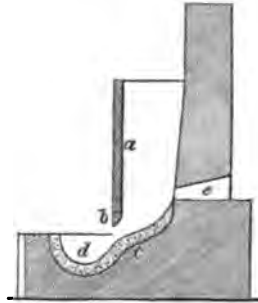

metre high and 0.07 metre wide; *c*, is the hearth sole formed of a mixture of small coal and loam; *d*, is the fore hearth; *e*, tuyere, 0.11 metre above the hearth sole.

Low furnaces suffice for this slag smelting, as the object is only to separate the mechanically enclosed tin, not to reduce that which is scorified; moreover, higher furnaces would reduce much iron from the slags. As this reduction of iron is not altogether to be avoided, even in low furnaces, and ferruginous deposits will be formed, the hearth is coated with

a mixture of small coal and clay or loam. The operations of this furnace last only 8 or 12 hours, so that it may be constructed of less refractory materials than the ore furnaces. The better to purify the tin, and to produce thin fused slags at the slag smelting, a stronger blast is employed, and the furnace fume and residues are also added in admixture.

After warming the hearth, the furnace is filled with coal and the blast put in motion; slags are then charged alternately with dry coal, both being measured. If the slag dust shows yellow stripes it is a sign of too low a temperature, and the charges of slag must be lighter. When the resulting slags are impure they are given back to the slag smelting; the pure slags which from the re-smelting have become tougher and richer in silica are thrown away; sometimes they are pounded and washed, and, after a proper dressing, returned to the slag smelting.

The resulting tin is refined in the same manner as the ore tin; the slags of three ore smeltings are worked up in one operation; 5 tons of tin ore yield about 36 cwts. of first slag and 3 or 4 cwts. of tin from these slags. Slags cooled in water yield more tin than when slowly cooled; the hot blast has proved of no advantage in this smelting process.

The slags have also been pounded and washed instead of re-smelted, but the tin grains were found to be converted by the pounding into small thin plates, and then washed away by the water, thus causing great loss of the purest tin.

The deposits, chiefly an alloy of iron and tin, frequently containing small amounts of copper, bismuth, tungsten, molybdenum, arsenic, and carbon, are poorer in iron since the ores have been purified by muriatic acid; they are dressed and added to the ore smelting. The deposits from the re-smelting of the slags still contain from 50 to 60 per cent of iron; they are broken into small pieces, roasted, and added to the slag smelting.

The ores treated at Schlaggenwald, in Bohemia, occur in gneiss, and contain about one per cent of tin. These tin

ores chiefly occur with wolfram, arsenical iron, and copper pyrites, and blende; wolfram, first separated as thoroughly as possible by hand sorting, is afterwards submitted to a pounding and dressing, and a schlich results containing about 50 per cent of oxide of tin; after being roasted and washed this schlich contains 58 per cent of tin. A treatment with acids is not required, as the ore contains only traces of bismuth. The roasted schlich is smelted in cupola furnaces 8 feet high, with charcoal and slags. Two cwts. of tin are tapped off every 2 hours, and in 73 hours 24 cwts. of tin are produced from  $2\frac{1}{2}$  tons of ore, at a consumption of 560 cubic feet of charcoal. The refined tin is formed into rolls each weighing 2 pounds, or into small bars. The residues of the refining process are re-melted in clay pots, and the mass is stirred with green brushwood, and yields some good tin.

According to Wallach, the tins produced in Schlaggenwald were composed in 1851-53 as follows:—

	Raw Tin.		Commercial Tin.		
	The most inferior.		Fine.	Middling.	Common.
Sn	95'339—	94'924	99'55	98'78	97'050
Cu	2'726—	3'648	0'28	0'87	2'326
Fe	0'684—	0'762	0'17	0'35	0'624
S and As	traces		—	—	—
Loss	1'251—0'666		—	—	—

A tin slag contained—

SiO <sub>3</sub>	. . . . .	24'060	Mn <sub>2</sub> O <sub>3</sub>	. . . . .	5'640
W <sub>2</sub> O <sub>3</sub>	. . . . .	24'330	CaO	. . . . .	3'580
FeO	. . . . .	20'750	MgO	. . . . .	0'370
SnO <sub>2</sub>	. . . . .	10'410	Loss	. . . . .	1'940
Al <sub>2</sub> O <sub>3</sub>	. . . . .	9'000			

The tin stone at Velleder, in Bretagne (France), occurs chiefly in veins and in alluvial deposits, in granite associated with quartz, iron ore, tourmaline, arsenical pyrites, &c.; it contains no wolfram. Part of the ore is exported to England, and part is smelted in Velleder in two cupola furnaces 4'65 metres high, for the production of good tin after it has been suitably dressed.

## REDUCTION OF TIN ORES IN REVERBERATORY

[www.libtool.com](http://www.libtool.com) FURNACES.

This mode of smelting is applied to purer ores, and the coal must be cheap and good. It is performed in the different smelting works with slight modifications; the reverberatory furnaces used have nearly the same construction everywhere, and allow a strong heat to be rapidly produced.

Figs. 143 and 144 represent the tin smelting furnaces\* at

FIG. 143.

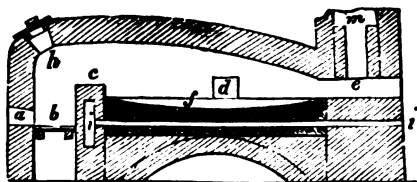
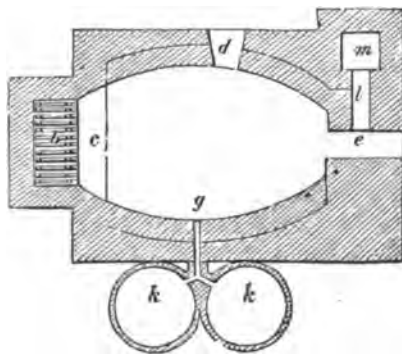

FIG. 144.



Truro, in Cornwall. Fig. 143 is a longitudinal section; Fig. 144 a ground plan. *a* is the fire door through which the pit coal is laid upon the grate (*b*); *c* is the fire-bridge; *d*, the door for introducing the ore; *e*, the door through which the ore is worked upon the hearth (*f*); *g*, the tapping hole; *h*, an aperture in the vault, which is opened when discharging the waste schlich to secure the free escape of the fumes, and to

\* Dr. URE's Dictionary of Arts, iii., 912.

lessen the amount of ore dust carried away; *i, i*, are air channels for admitting cold air under the fire-bridge and the sole of the hearth, with a view to ensure them against injury from the intensity of the heat above; *k, k*, are basins into which the melted tin is drawn off; *l*, the flue; *m*, the chimney, from 35 to 50 feet high.

Before throwing the roasted and washed schlich into the smelting furnace, it is mixed with from one-fifth to one-eighth of its weight of small coal or culm, and a little slaked lime or fluor spar is sometimes added to render the ore more fusible; occasionally also a small addition of common salt is employed. These materials are carefully blended and damped with water to render the charging easier, and to prevent the draught from carrying any away.

From 20 to 25 cwts. are introduced at a charge, and the doors are immediately closed and luted, while the heat is gradually raised. If the fire is too strong at first, the tin oxide will unite with the quartz of the gangue, and form an enamel. The heat is applied with closed doors for six or eight hours, by which time the reduction is finished. The door of the furnace is removed, and the melted mass worked up to complete the separation of the tin from the slag, and to ascertain if the operation be sufficiently forward. When the reduction appears finished the slags are taken out by the same door with an iron rake, and divided into three sorts: those of the first class, A, constituting at least  $\frac{1}{4}$  of the whole, are as poor as possible, and may be thrown away; the slags of the second class, B, which contain some small grains of tin, are sent to the stamps; those of the third class, C, which are removed last from the surface of the bath of tin, containing a considerable quantity of metal in the form of globules, are set apart to be re-smelted. These slags are in small quantity; the stamp slags contain fully five per cent of metallic tin.

As soon as the slags are cleared away the channel is opened leading to the basin or receiver, into which the tin consequently flows out; it is left there for some time in order that any slag still mixed with the metal may separate. When the tin has sufficiently settled it is ladled out, and

poured into cast-iron moulds, in each of which a bit of wood is fixed to form a hole in the ingot for the purpose of drawing the metal out when it becomes cold.

This tin is always more or less combined, principally with iron, copper, arsenic, and tungsten, and sometimes with small quantities of sulphides and arsenides that have escaped decomposition, of unreduced oxide of tin, and of earthy matters which have not passed off with the slags; it therefore requires a refining, which consists of two operations.

The first is a liquation which is effected in a reverberatory furnace, similar to that employed in smelting the ore (Figs. 143 and 144). The blocks are arranged on the hearth of the furnace near the bridge, and are heated moderately; the tin melts and flows away into the refining basin, but after a certain time the blocks cease to afford tin, and leave on the hearth a residue consisting of a very ferruginous alloy. Fresh tin blocks are now arranged on the residue of the first, and the liquation is continued till the refining basin contains about 5 tons; the residues are set aside for a treatment which will presently be described.

The second part of the process now begins; billets of green wood are plunged into the tin bath, and the disengagement of gas from the green wood produces a constant ebullition in the tin, raising a species of froth on its surface, and causing the impurest and densest parts to fall to the bottom. This froth is almost wholly composed of oxides of tin and foreign metals; it is repeatedly skimmed off and thrown back into the furnace. When the tin has boiled long enough, the green wood is lifted out, and the bath is allowed to settle. It separates into different zones, the upper being the purest; those in the middle are slightly charged with foreign metals, and the lower contain a large proportion of them. When the tin begins to cool, and when its different qualities cannot be more completely separated, it is ladled out and poured into cast-iron moulds. The successive blocks are obtained obviously in the order of their purity; those formed from the bottom of the basin being usually so impure that they must be subjected to a fresh refining process, as if they had been smelted directly from the ore.



The refining operations take five or six hours ; namely, one hour to fill the basin, three hours to boil the tin with the green wood, and one or two hours for the subsidence.

A simpler operation, called *tossing*, is sometimes substituted for the above artificial ebullition. A workman lifts some tin in a ladle and lets it fall back into the boiler from a considerable height so as to agitate the whole mass ; this is continued for a given time, after which the surface of the bath is carefully skimmed. The tin is afterwards poured into moulds, unless it is still impure, in which case the separation of the metals is completed by keeping the tin in the boiler in a fused state for a given time without agitation, so that the upper portion of the bath (at least one-half) is pure enough for the market.

The moulds into which the tin blocks are cast are usually made of granite ; their capacity is such that each block shall weigh a little more than 3 cwts. This metal is called block tin when offered for sale ; the purest block tin is called refined tin.

This treatment gives two stanniferous residues which have to be re-smelted ; they are—

1. The slags B and C, which contain some granulated particles of tin.

2. The dross found on the bottom of the reverberatory furnaces after re-melting the tin to refine it.

The slags C are smelted without any preparation, but those marked B are stamped in the mill, and washed to concentrate the tin grains, and from this rich mixture, called *prillions*, melted by itself, a tin of very inferior quality is procured. This may be readily imagined, since the metal which forms these granulations, being less fusible than the pure tin, solidifies quickly, and cannot flow off into the metallic bath.

When all the tin blocks have undergone a thorough liquation, the fire is increased to melt the less fusible residuary alloy of tin with iron and some other metals, and this is run into a small basin totally distinct from the refining basin. After this alloy has settled for some time, the upper portion is lifted out into block moulds as impure tin, which must be

refined again. On the bottom and sides of the basin there is deposited a white brittle alloy with a crystalline fracture, containing so large a proportion of foreign metals as to be almost useless. About  $1\frac{1}{4}$  tons of coal are consumed in the production of 1 ton of tin.

The following is an approximation to the annual production of tin in different countries :—

In Great Britain . . . . .	7,200 tons.
„ Southern Asia and East India . . . . .	7,500 „
„ Bolivia and Peru . . . . .	1,500 „
„ Saxony . . . . .	130 „
„ Bohemia . . . . .	60 „
„ Spain . . . . .	40 „

## CHAPTER VI.

### MERCURY.

#### PRINCIPAL ORES OF MERCURY.

The principal mercury ores are the following :—

1. **Cinnabar**,  $\text{HgS}$ , containing 86·2 per cent of mercury, but not always free from small admixtures of foreign substances, such as  $\text{Cu}_2\text{S}$ ,  $\text{Fe}_2\text{O}_3$ ,  $\text{Al}_2\text{O}_3$ , and earthy matters ; the largest amount of mercury is produced from this ore.

2. **Native Mercury**,  $\text{Hg}$ , occasionally containing some gold and silver ; it occurs in most of the mines yielding the other mercurial ores.

3. **Mercurial Fallow Ores**,—



containing from 2 to 15 per cent of mercury.

Many other mercurial ores are found, but not in quantities sufficient to allow of metallurgical treatment.

The geological position of mercurial ores in all parts of the world is in the strata which commence the series of secondary formations.

The chief localities of the ores are California, Mexico, Peru, Almaden in Spain, and Idria in Carniola ; they are also found in smaller quantities in France, Tuscany, the Palatinate, on the left bank of the Rhine, &c., and in China and Japan.

If cinnabar occurs in a massive state it is separated from the gangue either by hand sorting, or it is pounded and dressed by

machinery, so as to form small grains or schlich. When disseminated in the gangue the cinnabar is broken into small fragments and treated direct for the production of mercury. The native mercury associated with cinnabar is sometimes collected in the mine, as it crops out from the ore; a part is also collected whilst dressing the ores, but the greater quantity remains in the ores in small globules, and is extracted by appropriate metallurgical treatment.

#### SYNOPSIS OF PROCESSES FOR THE EXTRACTION OF MERCURY FROM ITS ORES.

The extraction of mercury from its principal ore (cinnabar) aims at the separation of the sulphur and the distillation of the liberated mercury, which takes place at  $360^{\circ}$  C. Sulphur may be separated either by a roasting process, transforming the sulphur into sulphurous acid ( $\text{HgS} + 2\text{O} = \text{Hg} + \text{SO}_2$ ), and volatilising the mercury as such, or by the use of fluxes, such as lime, iron scales, &c. Lime present in the ores exerts a decomposing action in the roasting process,—

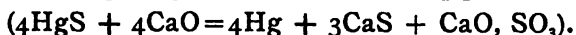

Modifications of the processes for extracting mercury result from varying the apparatus employed.

The choice of the distilling apparatus depends chiefly on the richness of the ore, on the size of the pieces, on the extent of the production, on the price of materials, and on the influence of the mercurial vapours upon the workmen and neighbouring vegetation, &c. *Galleries* or *gallery furnaces* are employed when rich ores are worked with cheap materials, and a small production only is aimed at. When aiming at a large production, massive ores are treated in *cupola furnaces* and small ores in *reverberatory furnaces*, but latterly small ores have been formed into lumps, and then advantageously treated in cupola furnaces.

Chambers are frequently used as condensers or receivers, and are found more effective than the clay tubes (Aludels) which were formerly employed. Clay tubes are at present advantageously replaced by wooden and cast-iron tubes, which

are cooled by water. It is essential, especially when employing gallery furnaces, that the size of the receivers should stand in proper proportion to the quantity of mercurial vapour developed in a given time, *i.e.*, to the ore charges and the amount of mercury contained in them. According to Mohr,\* 100 lbs. of mercury in form of vapour occupy a space of about 460 cubic feet.

The chief modes of extracting mercury from its ores may be classified under the two following divisions:—

### **I. DECOMPOSING SULPHIDE OF MERCURY BY ROASTING.**

The roasting process is carried out in different apparatus, and may accordingly be subdivided into—

1. **Roasting in Mounds**, applied in Hungary to mercurial fallow ores.

2. **Roasting in Cupola Furnaces**, applied to pieces in larger fragments. This process is sometimes carried on in short interrupted operations, whilst the mercury vapour is condensed either in tube-like clay vessels (Aludels), or in walled chambers of different shapes; the process is occasionally carried on in continuous operations, whilst different apparatus are employed for condensing the mercury vapour.

3. **Roasting in Reverberatory Furnaces** and condensing the mercury in cast-iron tubes; this plan is used for working small ore and schlich.

### **II. DECOMPOSING SULPHIDE OF MERCURY IN CLOSED VESSELS BY MEANS OF LIME OR IRON SCALE.**

This process may be subdivided into—

1. **The Process in Furnaces with short interrupted Operations.**—The furnaces and receivers are of different constructions.

2. **The Process with Ure's Furnace, with continuous Operations.**

All processes for the extraction of mercury yield the following products:—

\* Oesterr. Ztschr., 1856, p. 397.

*a. Metallic Mercury,\** containing mechanical admixtures, and sometimes also lead, bismuth, zinc, tin, oxide of mercury, &c. In order to separate these mechanical admixtures the mercury is either re-distilled, or pressed through moistened linen or fine leather; the metallic impurities can only be extracted by chemical reagents, such as acids.

The transport of mercury is effected either in double bags, made of soft sheepskin leather and placed in casks, or, as in Spain, &c., in wrought iron flasks with a screw stopper, and containing 76 lbs. each. It is sold in China in bamboo rods 1 foot long, 3 inches wide, each containing 29 lbs.

*b. Metallic Fume,* collecting on the side walls of the receivers, and consisting of an intimate mixture of finely divided mercury, sulphide, oxide, and chloride of mercury, volatile oils, soot, &c.† The metallic mercury is liberated by pressing it in a moistened state, sometimes with an addition of wood-ash. It is afterwards added to the ore mixture, or worked in a separate furnace.

*c. Residues,* containing clay, lime, &c. They are thrown away if sufficiently poor.

### I. Extraction of Mercury by Roasting Ores containing Sulphide of Mercury.

This mode of extraction possesses some advantages over the process of extracting mercury by means of fluxes, as it is cheaper, requires less time and fuel, and the decomposition of the ore, by means of the atmospheric oxygen and the direct influence of the flame, is more perfect. On the other hand, mercury vapour cools with more difficulty, as it enters the condensers together with hot gases, causing a considerable draught, which gives rise to a great loss of mercury if the condensers are not extensive and suitably constructed.

Spacious dry chambers, cooled by water outside, are used at Idria, Almaden, California, and Ripa, as condensers; they are so constructed in Castellazzara as to allow jets of

\* B. u. h. Ztg. 1857, p. 377; 1861, p. 316.

† B. u. h. Ztg., 1854, p. 240.

water to enter them, and at the Pionir mine, in California, they form a kind of channel with water flowing into it. All these forms are preferable to the so-called Aludels or stone-ware tubes. As the porous walls of the chambers imbibe a considerable quantity of mercury, they have lately been replaced at Idria by cast-iron tubes, with water flowing round them, and connected with condensation chambers and a chimney.

These cast-iron tubes, which waste rapidly under the influence of the sulphurous acid, are advantageously replaced by wooden tubes at Vallalta by Tome.\* They are cheaper, wear longer, and allow a better removal of the fume by means of small doors; the resulting fume is free from iron rust, and less of it is formed, therefore its removal and working up are less injurious to the workmen.

The older metallurgists confined their production of mercury almost entirely to the winter season, in order to prevent excessive loss, and to avoid the noxious influence of the vapour upon vegetation. If calcareous ores are worked with these condensers, the abundantly developed carbonic acid collects in the last condensation chamber, and, owing to its specific gravity, does not pass out of the chimney, thus checking the draught and prolonging the process. In such case the chimney is to be provided at its base with a channel opening to the air, and shut by a sliding door.

The process is now partly carried on in furnaces which must be allowed to cool after each charge, and before the residues are removed and a new charge given. They cause considerable waste of time and fuel, and are apt to crack, owing to the repeated expansion and contraction of the furnace walls; much vapour of mercury escapes, to the detriment of the workmen and the neighbouring vegetation. If walled condensation chambers, absorbing much mercury, are used at the same time, the loss of mercury is very great; so much that, for instance, the new Almaden mine in California produces only 25 per cent from ores containing 40 per cent of mercury. The furnaces used for this process are either

\* Oesterr. Ztschr., 1862, p. 197.

common cupola furnaces, provided with a grate in their lower part, or furnaces similar to brick kilns, with the fire-place on one side; these furnaces decompose the ores lying farthest from the grate less perfectly than those ores nearer to the fire-place.

Furnaces allowing continuous operations possess these disadvantages in a smaller degree if they have suitable condensers.

For this purpose cupola furnaces are employed for working ores in larger fragments. At Ripa, De Cossigny\* first constructed one of these furnaces, 4 metres high, rectangular in section, furnished with a movable grate, and provided with walled condensation chambers. Hähner† improved upon this furnace, chiefly by giving it a circular shape.

Poor small ore and schlich are worked in reverberatory furnaces, as they would lie too compactly in cupola furnaces, and hinder the requisite draught.

The smallest yield of mercury results from employing mounds for roasting the ores.

### Illustrations of the Process of Extracting Mercury in Mounds.

Mercurial fallow ores ‡ occur in different parts of Hungary (Iglo, Szlana, Altwasser); they are roasted for the extraction of their copper, and during this roasting the mercury is obtained as a by-product. The ores of the different localities have the following composition:—

Cu.	Fe.	Hg.	Ag.	Sb.	As.	S.
36'39	7'11	3'07	0'11	26'70	trace	25'90
34'23	9'46	3'57	0'10	33'33	"	19'38
30'58	1'46	16'69	0'09	25'48	"	24'37
32'80	5'85	5'57	0'07	30'18	"	24'89
39'04	7'38	0'52	0'12	31'56	"	22'00

The mounds employed are 42 feet long, 20 feet broad, and 4½ feet high, and are provided, at a height of 6 or 8 inches

\* Bulletin de la Société de l'Industrie Minérale. St. Etienne. tom. ii., p. 393.

† Ibid., i., pp. 301, 393. B. u. h. Ztg., 1854, p. 419. Berggeist, 1862, p. 341.

‡ B. u. h. Ztg., 1861, p. 151; 1842, p. 245; 1853, p. 708. Bgwkd. vi., 96; xvi., 618. Oesterr. Ztschr., 1853, No. 4 and 5. Pogg. Ann., lviii., 161; xcvi., 329.



from the bottom, with flues 6 inches high and 14 inches long. The sole of the mound is now covered with small ore, upon which is spread some ores previously burned, but mercurial; a layer of wood and coal is next made, in the middle of which triangular shafts are formed by pieces of wood, 12 feet distant from each other. The ore of different richness, which had been used as the outside covering of the former roasting, is not attacked by the fire, and is therefore placed on the wood 3 or 5 inches high; then schlich already burned is placed round the walls in a strip 2 feet broad and 6 inches high, in order to prevent too strong a draught. The middle is filled up with poor fresh ore also, to a height of 6 inches, and the mound is filled up with medium and best ores, until they project 4 inches above the walls, but somewhat lower in the middle of the mound.

When the shafts are kindled by glowing coals, and filled up with small coal, the decomposition of the sulphides commences; vapours of mercury rise and condense in drops in the higher ore layers. As soon as the uppermost layer of ore is partly warmed, or vapour of mercury escapes, it is covered with fresh ore, as well as the places where the ore has sunk. The roasting process is finished in three weeks; the upper layers of ore, containing the condensed mercury, are carefully removed by iron shovels, thrown on a copper sieve standing upon a tub, and washed with water. The mercury and the fine ore then fall together into the tub; the coarser ore remaining on the sieve is given back to the roasting. The fine ore is then bolted, thus separating the mercury and uniting it in larger masses; it is kept in copper vessels; the remaining schlich is also added to the next roasting. The upper layers of ore are treated in this manner as long as they contain traces of mercury; the lower layers, having been roasted twice, are given to the raw smelting for the extraction of their copper and silver.

1,624 $\frac{3}{4}$  tons of ore, containing, according to assay, 24 $\frac{3}{4}$  tons 915 lbs. of mercury, yielded 21 tons 16 $\frac{1}{2}$  cwts. of mercury, with a consumption of 7,795 cubic feet of coal, and 37,800 cubic feet of wood. In 1861, Hungary produced 32 $\frac{1}{4}$  tons of mercury as a by-product of the roasting of fallow ores. The

extraction is profitable even if the ores contain no more than  $\frac{1}{4}$  per cent.

[www.libtool.com.cn](http://www.libtool.com.cn)

### Illustrations of the Extraction of Mercury in Cupola Furnaces with Interrupted Operations.

A. *Old Process at Idria,\* in Carniola.*—The cinnabar ore occurring in bituminous schists is metallurgically classified : 1, into ores in large blocks, fragments, or splinters, varying in size from a cubic foot to the size of a nut ; and 2, into smaller ores, from the size of a nut to that of a grain of the finest sand.

The first class of large ores comprises three subdivisions, namely, *a*, blocks of metalliferous rocks, which are the most abundant and the poorest species of ore, affording only 1 per cent of mercury ; *b*, massive sulphide of mercury, the richest and rarest ore, yielding 80 per cent, when it is picked ; *c*, fragments or splinters proceeding from the breaking and sorting, and varying in value from 1 to 40 per cent.

The general aspect of the apparatus is indicated by Figs. 145, 146, 147, and 148.

FIG. 145.

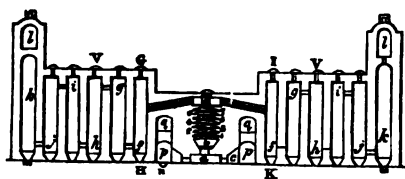

FIG. 146.

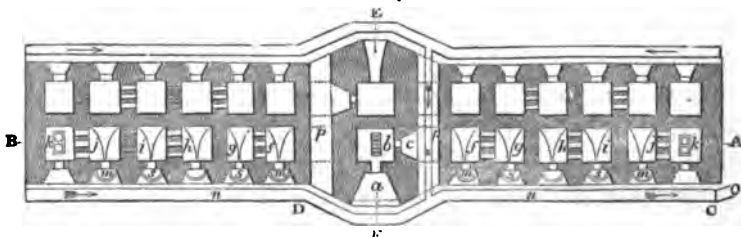

Fig. 147 represents half only of the exterior, as the two

\* URE'S Dictionary of Arts, iii., p. 70.

FIG. 147.



halves exactly resemble each other. In these figures the following objects are to be observed:—Figs. 145 and 146, *a*, is the door of the fire-place; *b*, the furnace in which beech-wood is burned, mixed with a little fir-wood; *c*, the door of the ash-pit, extended beneath; *d*, a space in which the ores are deposited upon the seven (sometimes less) arches, 1 to 7, as indicated in Figs. 145 and 148; *e, e*, brick tunnels by which the smoke of the fuel and the vapours of mercury pass, on the one side, into successive chambers (*f, k*). *f, g, h, i, j, k, l*, are passages which permit the circulation of the vapours from the furnace (*a, b, c, d*), to the chimneys (*l, l*). Figs. 145 and 146 exhibit clearly the distribution of these openings on each side of the same furnace, and in each half of the apparatus, which is double, as Fig. 146 shows; the spaces without the letters being in every respect similar to the spaces mentioned below. The scale of Fig. 146 is double that of Fig. 145.

*m, m'*, Fig. 146, are receiving basins, distributed before the doors of each of the chambers (*f, k, f', k'*), to which the condensed mercury flowing out of the chambers is conveyed. *n, n'*, is a trench into which the mercury is poured after being lifted into the basins (*m*), so that it may run towards a common chamber (*o*) in the sloping direction indicated by the arrows. *o*, leads to the chamber where the mercury is received in a porphyry trough, out of which it is ladled and packed up in portions of 50 or 100 lbs. in sheep skins prepared with alum. *p, p'*, Fig. 145, are vaulted arches, through which a circulation may go on round the furnace (*a, b, c, d*), on the ground level. *g, g'*, are the vaults of the upper stories. *r, r'*, Fig. 147, are vaults which permit access to the tunnels (*e', e'*), Fig. 148.

*s, s'* and *t, t'*, Fig. 147 are the doors of the chambers (*f, k*, and *f', k'*). These openings are shut during the distillation by wooden doors faced with iron, and luted with a mortar of clay and lime. *u, u'*, is the door of the vaults 1 to 7 of the furnace represented in Fig. 145, and these openings are also hermetically shut. *v, v'* Fig. 145 are superior openings of the chambers closed during the operation by luted plugs; they are afterwards opened to facilitate the cooling of the apparatus, and to collect the mercurial fume. *z, y, x* Fig. 148, are floors which correspond to the doors *u, u'*, of the

FIG. 148.



vaults 1 to 7 Fig. 145. These floors are reached by stairs set up in the different parts of the building which contains the whole apparatus.

The largest blocks of metalliferous rock are laid on the lower arches; over these are arranged the less bulky fragments, which are covered with the splinters and pieces of less dimension. On the middle vault the small ore is placed, distributed in cylindrical pipkins of earthenware, 10 inches in diameter and 5 inches deep. The upper vaults likewise receive pipkins filled with schlich.

In three hours the two double sets of apparatus are charged, and all the apertures are closed, by the labour of 40 men. A quick fire of beech-wood is then kindled and the temperature gradually raised to a cherry-red heat, which will be in about 12 or 15 hours. Including the time for cooling, an operation lasts about a week. A complete charge

for the two double apparatus consists of from 1,000 to 1,300 cwts. of ore, which will produce from 80 to 90 cwts. of fluid mercury.

Of late the large ores are treated in a cupola furnace with continuous operations; and the small ores in reverberatory furnaces.

The production of mercury in Idria amounted, in 1861, to 4,006 cwts.

*B. Process at Almaden,\* in Spain.*—The cinnabar ore occurs here in a vein from 18 to 60 feet wide, in clay slate, and is associated with calc spar and quartz. As the processes employed are so very imperfect, they only yield  $\frac{1}{3}$  or  $\frac{1}{4}$  of the mercury contained in the ores.

Two different apparatus are used.

1. Aludel furnaces, introduced in 1646, by Juan Alonso Bustamente, from Huancavelica, in Peru. Figs. 149, 150, 151, 152, represent these furnaces. Figs. 149 and 152 repre-

FIG. 149.

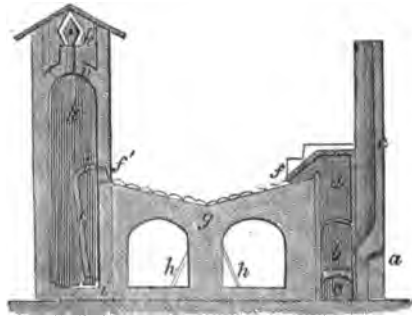
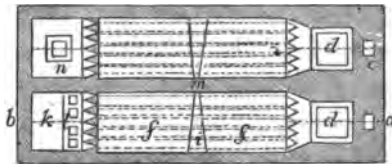

FIG. 150.



\* Dr. URE'S Dictionary of Arts, vol. iii., p. 69. Ann. d. min., 3 sér., v., 196; vi., 362. Bgwkfd. xiii., 72; v., 560; xvi., 144. B. u. h. Ztg., 1842, p. 939; 1849, p. 311; 1861, p. 417. Revista Minera., tom. xii., No. 276.

FIG. 151.

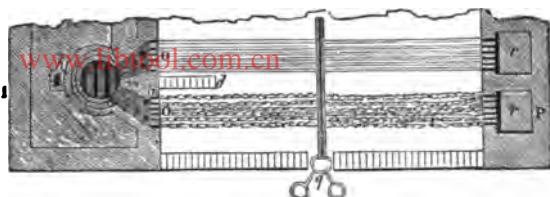
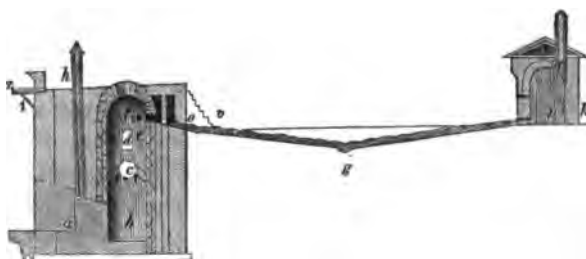

FIG. 152.



sent two vertical sections, and Figs. 150 and 151 two plans of two similar furnaces, joined by one body of brickwork. The following description will apply to the four figures:—*a*, is a door by which the wood is introduced into the fire-place (*b*); this is perforated with holes for the passage of air; the ash-pit (*c*) is seen beneath. An upper chamber (*d*) contains the mercurial ores distributed upon open arches, which form the perforated sole of this chamber. Immediately over these arches large blocks of limestone, very poor in mercurial ore, are piled up in a dome; above these are laid blocks of a smaller size, then ores rather inferior in quality, and stamped ores mixed with rich minerals; lastly, the whole is covered up with soft bricks, formed of clay kneaded with schlich and small pieces of sulphide of mercury. Six ranges of pear-shaped aludels, or stoneware tubes (*f, f*) luted together with clay, are mounted in front of each of the two furnaces on a double sloping terrace, having, in the lowest part, two gutters (*t, v*) a little inclined towards the intermediate wall (*m*). In each range the aludel placed at the line *t, m, v*, that is to say, at the lowest point (*g*, Figs. 149 and 152), is pierced with a hole, through which

the mercury which has been volatilised in *d*, if it is already condensed by the cooling in the series of aludels (*f*, *g*), may pass into the corresponding gutter, next into the hole (*m*), Fig. 151, and after that into the wooden pipes (*h*, *h'*), which conduct it across the masonry of the terrace into cisterns filled with water; see *q*, Fig. 151, which is the plan of Fig. 152.

The greater portion of the mercury is not condensed in the range of aludels, and goes in the state of vapour into a chamber (*k*); but in passing under a partition (*l*, *l*) a certain portion is deposited in a cistern (*i*) filled with water. The greater part of the vapours diffused in the chamber (*k*) is thus condensed, and the mercury falls down upon the two inclined planes which form the bottom, any remaining vapour passing into an upper chamber (*k'*) by a small chimney (*n*). On one of the sides of this chamber there is a shutter which may be opened at pleasure from below upwards, and beneath this shutter is a gutter in which a considerable quantity of mercury collects; a fair amount is also found condensed in the aludels. Twenty-five aludels are set in each of the twelve ranges, constituting 300 pear-shaped stoneware vessels, open at both ends, merely thrust into one another and luted with loam. *a*, is the door of the fire-place; *c*, the perforated arches upon which the ore is piled in chamber (*e*) through the door (*d*) and an orifice at the top, which is closed during the distillation; *f*, *f*, are vents for conducting the mercurial vapours into two chambers (*i*) separated by a triangular body of masonry (*m*, *n*); *h*, is the smoke chimney of the fire-place; *o*, *o*, are the ranges of aludels, in connection with the chamber (*i*), which slant towards the gutter (*g*) upon the double inclined plane terrace, and terminate in the chamber (*h*, *g*), which is surmounted by two chimneys (*t*). The mercury is collected in these aludels and in the basins at *q* and *p*, Fig. 151; *v*, is the stair of the aludel terrace, leading to the platform which surmounts the furnace; *z*, is a gutter for conducting away any rain falling upon the buildings, Fig. 152.

The furnace shaft, composed of a fire-place and space for the ore, is 6 feet wide and from 25 to 30 feet high. A charge

consists of about  $11\frac{1}{2}$  tons of ore, which is distributed in the furnace as follows:—18 cwts. of non-metalliferous or dead mineral in large pieces are used to cover the grate (perforated arched roof), upon this 21 cwts. of large pieces of ore, yielding from 0·25 to 0·75 per cent of mercury, are placed, then 51 cwts. of ore in smaller pieces containing from  $4\frac{1}{2}$  to 6 per cent; they are covered first with 1 ton 17 cwts. of ore containing from 15 to 20 per cent, and then with 2 tons 11 cwts. of ore containing  $4\frac{1}{2}$  to 6 per cent; and on the top of all 2 tons 6 cwts. of small ore formed into bricks. After having walled up the charging openings, a strong fire is kept on the first day for 10 hours; the furnace is then left for the night, and the remaining glowing coals are stirred on the following morning to heat the air passing through the furnace. The furnace is allowed to cool on the third day, and the residues are removed on the fourth. Most mercury is obtained on the second day.

The loss of mercury is considerable, and the aludels are very friable and troublesome to keep tight; the process is also very unhealthy for the workmen, and has the disadvantage of being interrupted after each charge.

2. The furnaces of Idria have been introduced into Almaden since 1860. They have  $2\frac{1}{2}$  times the capacity of the aludel furnaces. It is a singular fact that here, as in Idria, the vapours of mercury have the greatest tendency to escape through the walling in the third chamber.

About 13,300 tons of mercurial ores are annually worked in 2 furnaces of Idria, and 8 aludel furnaces, yielding from 7·5 to 8·5 per cent, or about 1,000 tons of mercury, which is sold in iron flasks 15 inches long, and 5 or 6 inches wide, each containing about 87 lbs.

C. *Process at New Almaden, in California.*—Mercury is produced by adding cinnabar to the limestone intended for burning in cupola furnaces. The furnace (brick kiln), capable of containing 20 tons of ore, is 7 feet long, 4 feet broad, and 5 feet high, and is furnished on one side with a fire-place from 3 to 5 feet high, which is separated from it by a perforated partition wall. It is connected with eight or nine walled condensation chambers, and with a wooden chamber



in which a continual shower of water is kept up. The uncondensed vapour escapes by a wooden chimney. The fire is kept up for 60 hours, and the furnace requires 48 hours for cooling. The walls of the condensation chambers imbibe, before any mercury is yielded, about 2 tons of mercury, and ores containing 40 per cent, yield at the utmost 25 per cent. Both workmen and vegetation are much injured by the vapours, but as the production is exceedingly profitable, larger furnaces of 100 tons capacity have lately been erected.

In California more profitable apparatus has been introduced into other establishments.

#### Illustrations of the Extraction of Mercury in Cupola Furnaces with continuous Operations.

A. *New Process in Idria*.—Since 1850 this process has been used with greatest advantage for working ores in pieces larger than 2 or 4 inches square. The furnaces constructed by Hähner are represented by Figs. 153 and 154. *a*, is the furnace shaft for receiving the ore; *b*, the funnel for charging the ore; *c*, the grate constructed of movable iron rods  $2\frac{1}{2}$  inches distant from each other; *d*, is a tramway used for transporting the roasted ores; *e*, a sliding valve; *f*, a flue connecting the furnace with six condensation chambers (*g*); they are covered with iron plates (*i*), upon which flows a continuous stream of cold water. The walls of the chambers are constructed of bricks, and coated with a mortar of lime and sand; *h*, chimney in three tiers one above another, forming terraces upon which cold water is conducted; *k*, openings by which the chambers communicate with each other; *l*, sole of the chambers, consisting of three layers, the highest and lowest formed of loam, and the middle layer of brick-work.

A certain number of bricks, with pieces of wood between them, are placed upon the grate to reduce its interstices, then brush-wood or coal, upon which poor ore is charged. The furnace is now filled with richer ore and coal in alternate layers to a height of about 4 metres. The wood upon the grate is kindled, and the fire made to rise so slowly that it

FIG. 153.

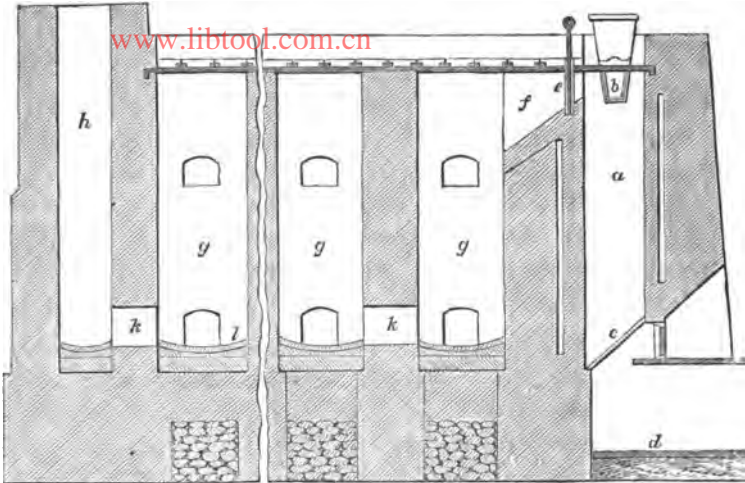
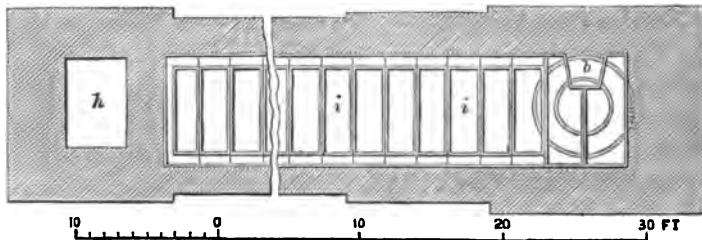

FIG. 154.



only appears on the upper surface of the charges at the end of the second day, thus preventing too great a development of steam. Ore charges of 7 cwts. each, with 3 or 4 per cent of charcoal are then made about every  $\frac{3}{4}$  of an hour, by means of the hopper, whilst any roasted ore of a certain quality is removed in waggons on the tramway. The charges remain in the furnace about 22 hours.

The ores, containing on an average 3.11 per cent mercury, yield 1.90 per cent. One cwt. of mercury in Idria costs for its production about £6, namely, £4 for the ore, £1 12s. for smelting, and 8s. for package; the market price is about £17 16s. per cwt.

B. *In Tuscany*.\*—Cinnabar is found occurring in mica-slate in different parts of Tuscany, and is treated at the smelting works of Ripa and Castellazara for the production of mercury.

Ure's furnace was formerly used at Ripa, and lately replaced by Cossigny's cupola furnace; this is now superseded by Hähner's furnace, which allows a saving of fuel and a cheaper dressing of the ores, as this furnace does not require ores so perfectly dressed. These furnaces treat daily about 4 tons of ore, nearly in the state in which it comes from the mine, consuming about 320 lbs. of coal; 1 ton of ore yields about 5 or 6 lbs. of mercury.

The Hähner furnaces at Castellazara are provided with a more complete system of condensation chambers than those at other places. The shaft of the furnace, 2·2 metres high above the grate and 0·4 metres wide, communicates with three walled condensation chambers, each 2 metres high and 0·75 metre wide, by means of an inclined flue 1·2 metres long and 0·16 metre high. The hemispherical bottom of the chambers is constructed of cast-iron and provided with a tube, through which the mercury runs into a vessel standing below. A channel, 0·3 metre high and 7 or 7½ metres long, leads from the third chamber 0·4 metre above its bottom, and has first a downward curve, and is then somewhat inclined and partly covered with water. It enters a condensation chamber 1 metre wide and 1·5 metres high, and jets of water play on this point. From the last chamber issues a channel 0·4 metre high, somewhat ascending to a vertical chimney 0·16 metre wide; both chimney and channel are provided with sliding doors, and this channel is also used to get rid of the evolved carbonic acid.

Poor ores, for instance those containing from 0·003 to 0·004 per cent of mercury, and clay earth poor in cinnabar, are treated in this furnace. The cost of distilling 1 cwt. of ore amounts to about 1·4d. The largest amount of mercury and a great deal of rich mercurial fume are collected in the first three chambers; a great deal of pure liquid bitumen,

\* *Bullet. de la Société de l'industrie minérale*, St. Etienne, ii., 383, 390, 401.

and a creosote-like empyreumatic oil collect at the end of the channel standing under water.

C. At *Vallata*,\* in Venetia, mercurial ores are found in porphyry, varying in richness from 0.5 to 60 and even 70 per cent; the average amount of the whole mass not being, however, more than 0.75 per cent. The ores in fragments were formerly worked in cupola furnaces and the schlich in reverberatory furnaces, but the increasing price of wood has led to a treatment of the schlich in cupola furnaces. It is formed into lumps after being moistened with the vitriol lixivium obtained in the distilling process previous to treatment.

The cupola furnace is connected with wooden condensation tubes.

D. At the *Pionir mine*, in California,† a cupola furnace 20 feet high and 4 feet wide is used. Its counters are separated from the rough walling by a space 6 inches wide, and filled up with wood ashes. This construction allows expansion of the counters, and prevents any escape of mercurial vapours by cracks. The mercurial vapours are led on to a surface of water by means of an iron tube at an angle of 40°, which condenses the greater part of them. The escaping vapours pass through a channel coated with cement, 300 feet long, and ascending at an angle of 20° up a hill into a chimney. The condensed mercury is washed by water from the top of the channel to the lowest point, where it is tapped off; the channel is thus kept constantly filled with steam of low pressure which assists the condensation of the mercurial vapours.

#### Illustrations of the Extraction of Mercury in Reverberatory Furnaces with continuous Operations.

This method of extraction is used at Idria‡ to work small ore containing from  $\frac{1}{4}$  to 1 per cent of mercury, and is found to answer well. The furnaces constructed by Alberti are represented by Figs. 155, 156, and 157. *a* is the hearth of

\* Oest. Ztschr., 1862, p. 195. B. u. h. Ztg., 1861, p. 419.

† Berggeist, 1862, p. 341.

‡ TUNNER'S Jahrb., 1852, pp. 50, 263. Ann. d. min., 1 livr., de 1854, p. 42.

FIG. 155.

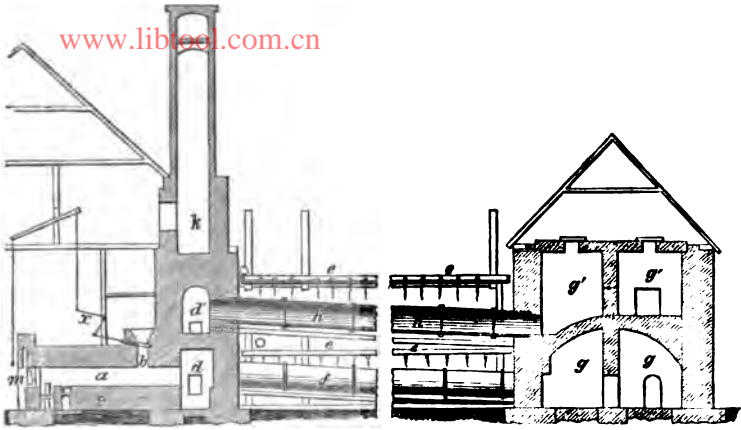

FIG. 156.

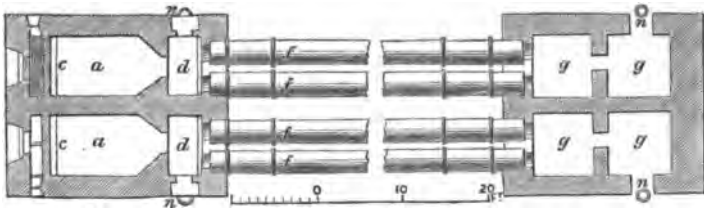
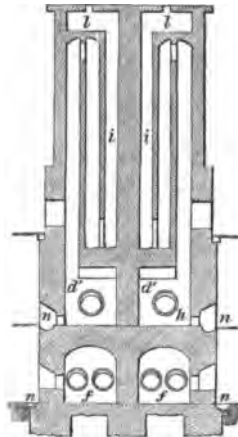

FIG. 157.



the reverberatory furnace in three partitions; *b* is the hopper for charging the ore which may be closed by the sliding door; *c* is a space between hearth and fire-bridge for receiving the roasted ore from the first partition; *d*, walled chambers; *e, e*, wooden gutters filled with water; these are perforated, and the holes are partly closed with wooden plugs fitting imperfectly, so as to allow a constant dropping of water. *f, f*, lower cast-iron condensation tubes cooled by the dropping water, and intended to condense the mercury vapours. The uncondensed vapours are conducted to two lower chambers (*g*), and two upper ones (*g'*); from these they enter the chamber (*d'*) by means of the tubes (*h*), and afterwards the chimney (*k*), which is divided into three compartments by two vertical brick walls (*i*) six inches thick. Finally all the uncondensed products of combustion escape into the open air at *l*. *m* is the working door with a little chimney above; *n*, vessels for receiving the mercury condensed in the tubes (*f*).

The small ore of two or three cubic inches in size is charged in quantities of  $2\frac{1}{4}$  tons by means of the hopper (*b*), and spread out upon the hearth in a layer 5 or 6 inches high. The first half of the hearth is now heated to redness with pieces of wood 3 feet long, the working door being closed and luted; the fire is then allowed to go partly out, the hot small ore is turned for five or six minutes, and the working door again closed and luted, the fire is raised for about twenty minutes till the turned ore on the first half of the hearth becomes red hot. At this point the ore lying on the first third of the hearth is removed into the space *c*. The ore on the second third is turned and placed on the first third of the hearth, and that on the last third is placed on the second, whilst a new charge of 15 cwts. of ore is added on the last third in such a manner that half of the charge is spread out and the other half remains in a heap. The working door is again closed, and the first half of the hearth heated till red hot, when the ore is removed as before.

The following products result from this process:—

*a*. Mercury, including that contained in the products and collected in the different condensers, in the following proportions:—

0.6	per cent in the first chamber ( <i>d</i> ).
95.1	„ „ lower tubes ( <i>f</i> ) and the chambers ( <i>g</i> ).
2.8	„ „ upper tubes ( <i>h</i> ) and the chambers ( <i>g'</i> ).
1.5	„ „ chamber ( <i>d'</i> ).

---

100.0

*b.* **Mercurial Soot or Fume** from the chambers, containing about 50 per cent of mercury. It is dried on dishes, and raked about on an inclined plane by wooden rakes till mercury ceases to flow out. The residue, containing from 15 to 20 per cent of mercury, is heated in iron tubes which are connected with condensation tubes; the condensed mercury runs out from the condensation tubes into a reservoir; the chambers are cleaned once a year.

*c.* **Residues** from the iron tubes, consisting of water, carboniferous soot, particles of ore, drops of mercury, empyreumatic products, &c., and forming a slime which solidifies later. They contain from 40 to 50 per cent of mercury, are removed every six months, and are treated in the same manner as the mercurial soot.

Two Alberti furnaces placed side by side work 13 tons of ore and 10 tons of schlich daily, involving a loss of from 5 to 10 per cent of mercury. Cupola furnaces and large ore consume about 25 cubic feet of wood per cwt. of mercury, and reverberatory furnaces about 50 cubic feet.

## II. Extraction of Mercury by the Decomposition of Cinnabar by Fluxes in Closed Vessels.

This method requires more time and fuel, and a finer division of the ores, so that they may mix properly with the fluxes; it is therefore more expensive. On the other hand, it allows a more perfect condensation of the mercury, and is less hurtful to the workmen.

Whilst furnaces with interrupted operations require the richest ores, and consume more fuel with a smaller production, Ure's furnaces with continuous operations are cheaper to work, and give a larger production if the condensers are suitably constructed.

Ure's furnace is used with some modifications. In some furnaces the fire is placed below the hearth, and in others at the side of it; but the first arrangement is preferable, as the fuel is most advantageously used when the flame is conducted below; the construction of the condensers varies little in the different smelting works.

The distilling vessels are made either of clay or of cast-iron, and placed in a horizontal or vertical position; the bell apparatus at Horowitz are similarly constructed.

In California\* a comparison of the furnaces with interrupted operations and Ure's furnace gave the following results:—

Supposing the cost per day for labour to amount to 3 dollars, and for fuel to 4 dollars per 112 cubic feet, the cost of reducing 1 ton of ore would amount respectively to 4 and 16 dollars, or 12 dollars more in retort furnaces, corresponding to 30 lbs. of mercury, or  $1\frac{1}{2}$  per cent. Rich ores containing from 20 to 30 per cent of mercury will give five times as good a result if worked in retort furnaces, whilst poor ores cannot be treated in them. One disadvantage of the retorts is their small production, as the heat does not penetrate the ore sufficiently on account of their larger dimensions, and the mercurial vapours escape with difficulty. A larger production entails a larger establishment and more workmen.

Rotating retorts have been tried with a view to avoid these disadvantages, but reduction will always be more expensive than the treatment of ores in cupola furnaces, though the greater yield may overbalance it when treating rich ores.

### Illustrations of the Process of Extracting Mercury in Furnaces with interrupted Operations.

*Older Method in the Palatinate.*†—The poor ores worked here are cinnabar disseminated in sandstone, usually containing 0.005 per cent, sometimes 0.01 per cent of mercury. They must contain at least 0.00166 in order to make their working

\* Berggeist, 1862, p. 342.

† Journ. d. min., Nos. 6, 7, 17. B. u. h. Ztg., 1860, p. 398. Bgwkd., i., 256. KARST. Archiv., 1 R., iii., 36; 2 R., xxii., 375.



profitable ; they are sorted by hand and worked in pieces of the size of a walnut down to the size of a lentil. The furnaces used are the so-called gallery furnaces.\* They are so constructed as to contain four ranges ( $a, a', b, b'$ ), of large retorts, styled *cucurbits*, of cast-iron, in which the mercury ore is subjected to distillation. This arrangement is shown in Fig. 158, which gives a vertical section on the line ( $a, b$ ) of

FIG. 158.

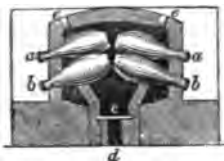

the ground plan (Fig. 159). In the ground plan the roof of the furnace (Fig. 158) is supposed to be lifted off in order to show the disposition of the four ranges of cucurbits upon the grate ( $c$ , Figs. 159 and 160), which receives the pit coal as fuel. Under this grate extends an ash-pit ( $d$ ), shown in Fig. 160, which exhibits an elevation of the furnace, as well

FIG. 159.

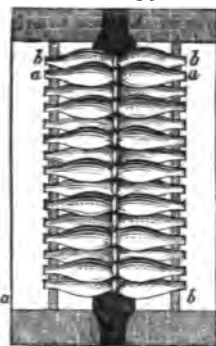
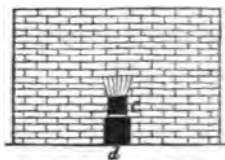

FIG. 160.



\* URE'S Dictionary of Arts, iii., p. 68.

as one of the two doors (*c*), by which the fuel is thrown upon the grate. Openings (*e, e*, Fig. 158), are left in the arch of the furnace, whereby the draught may receive a suitable direction. The grate of the fire-place extends over the whole length of the furnace (Fig. 159), from the door *c* to the door *f*, situated at the opposite extremity. The furnace usually includes 30 cucurbits, but occasionally as many as 52. Into each are introduced from 56 to 70 lbs. of ore and 15 to 18 lbs. of quick lime, an admixture which fills no more than  $\frac{2}{3}$  of the cucurbit; a stoneware receiver is adapted to the neck, containing water to half its height. The fire is moderate at first, and afterwards increased till the cucurbits are red hot. When the operation is concluded the contents of the receivers are poured into a wooden bowl placed upon a plank above a bucket; the mercury falls to the bottom of the bowl, and the water carries over the black mercury, as the substance coating the inside of the receivers is called. This is considered to be a mixture of sulphide and oxide of mercury. The black mercury is taken out of the tub and dried, and re-distilled with an excess of lime, after which the residue in the retorts is thrown away as useless.

At Landsberg, near Obermoschel, one charge of 5 cwts. of ore mixed with 1 or 2 cwts. of lime is finished in about 6 hours' time, or three distillations daily, consuming 15 cwts. of coal, and producing about  $\frac{1}{2}$  cwt. of mercury; 60 tons of ore and 150 tons of coal, therefore, are required for the production of 5 tons of mercury, whilst at Potzberg 400 tons of ore and 100 tons of coal are used for the same production.

At Horzowitz, in Bohemia,\* cinnabar was formerly treated in bell furnaces similar to those used for silver amalgam in admixture with iron scales. Quantities of half cwts. of ore and quarter cwts. of iron scale were heated for 30 or 36 hours.

At Zalathna, in Transylvania, gallery furnaces with 60 stoneware retorts, and lime as a flux, were formerly used, but they have been superseded by Ure's furnaces.

\* ROSENBAUM in *Bergbaukunde*, i., 200. GMELIN, *Handb. d. Chem.*, iii., 468.

**Illustrations of the Extraction of Mercury in Furnaces  
with continuous Operations.**

*A. New Method used in the Palatinate.\**—In 1847, a new distillation apparatus, represented by Figs. 161, 162, and 163, was introduced into Landsberg by Dr. Ure.

Fig. 161 is a section, parallel to the front elevation, of three arched benches of retorts, with an area of at least 1 square foot, and 7 feet in length. Each bench contains three retorts, whose shape is shown by *a, a, a*; 1, is the single fire-place or furnace, capable of giving adequate heat to the three

FIG. 161.

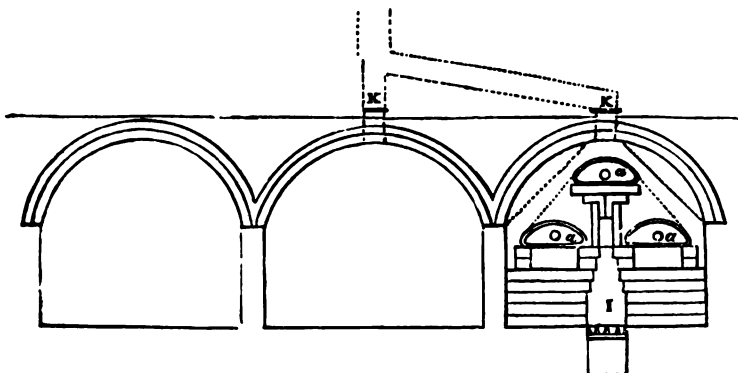
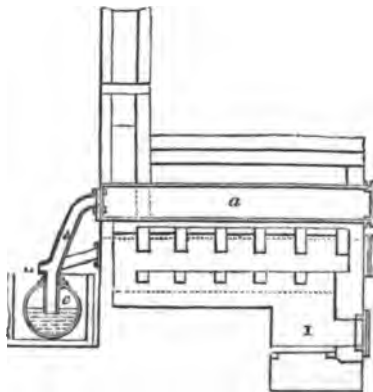
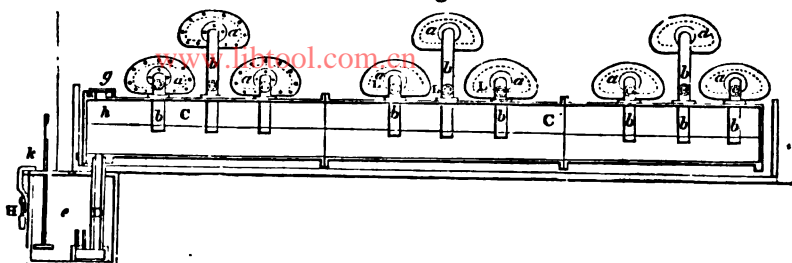

FIG. 162.



\* URE'S Dictionary of Arts, iii., 72.

FIG. 163.



retorts, by coal or wood. In the section (Fig. 162) *a* is the body of the retort; its mouth is at the right hand, and is shut by a luted iron, secured with a cross bar and screw bolts; its other end is prolonged by a sloping pipe of cast-iron 4 inches in diameter, furnished with a nozzle hole (*l*), closed by a screw plug. A wire rod may be introduced through this hole to ascertain that the tube is pervious, and to cleanse it from the mercurial soot when necessary. *e* is a cross section of the main condenser, shown in a longitudinal section at *c, c* (Fig. 163). This pipe is 18 inches in diameter, and about 20 feet long. At *a, a, &c.*, the back ends of the retorts are seen with the slanting tubes *b, b, &c.*, descending through orifices in the upper surface of the condenser pipe, and dipping their ends just below the water line (*h, i*); *g* is the cap of a water valve which removes all risk of danger from sudden expansion and condensation. The condenser is placed within a rectangular trough, made either of wood or stone, through which a sufficient stream of water passes to keep it perfectly cool, and condense every trace of mercurial vapour. It has a slight inclination from *i* to *h*, so that the condensed mercury may spontaneously flow along the bottom, and pass through the vertical tube (*D*) into the locked iron chest or magazine (*e*). This tube (*D*) is from the beginning closed at the bottom by immersion in a shallow iron cup always filled with mercury; *k* is a graduated gauge rod to indicate the progressive accumulation of mercury in the chest.

As the retorts are kept in a state of nearly uniform ignition, like those of gas works, neither they nor the furnaces

are liable to be injured in their joints by the alternate contractions and expansions which they would inevitably suffer if allowed to cool; and being always ready heated to the proper degree for decomposing the mercurial ores, they are capable of working off, under skilful management, a charge in 3 hours; thus, in 24 hours, with a relay of labourers, 8 charges of at least 5 cwts. each might be smelted, equal to 2 tons with three retorts, and 6 tons with nine retorts.

The ore treated in this furnace should be ground to a moderately fine powder, so that when mixed with quick lime the cinnabar may be brought into intimate contact with it.

*B. Method at New Almaden and New Idria\* in California.*  
—According to Beale, the cinnabar ores contain—

Hg . . . . .	69'90
S . . . . .	11'29
Fe . . . . .	1'23
CaO . . . . .	1'40
MgO . . . . .	0'49
Al <sub>2</sub> O <sub>3</sub> . . . . .	0'61
SiO <sub>2</sub> . . . . .	14'41

400 lbs. of ores of the size of a nut, and mixed so as to contain 40 per cent of mercury, are mixed with 600 lbs. of pulverised quick lime, and heated in iron retorts at a moderate red heat for from 21 to 32 hours, according to the quality of the fuel (wood). The mercurial fume condenses in a vertical conical receiver, which is kept cool by dropping water upon it. The resulting mercury is tapped off by a pipe.

100 lbs. of ore, containing 40 per cent of mercury, consume an equal quantity of good air-dried wood; 100 lbs. of ore, containing 1 per cent of mercury, require 50 lbs. of wood.

Some establishments use vertical retorts, each 8 feet long. One of these retorts treats 125 lbs. of ore, mixed with quick lime, in 4 hours. The volatilised mercury collects in receivers under water. The rotating retorts, 3 feet long and 2½ feet wide, at Enriqueta mine, treat the same quantity of ore (125 lbs.) in 2 hours.

\* B. u. h. Ztg., 1851, p. 769; 1857, p. 377.; 1861, p. 316; 1862, p. 227. Bgwkd., xvi., 144. Berggeist, 1856, p. 219; 1858, p. 165; 1862, pp. 337, 342.

In 1861, the production of mercury throughout the world amounted to 3,050 tons ; of these were produced—

In California . . . .	1775 tons.
„ Almaden, in Spain . . . .	1000 „
„ Huancavelica, in Peru . . . .	150 „
„ Germany, Austria, and France	125 „
	<hr/>
	3050 tons.

## CHAPTER VII.

### BISMUTH.

#### PRINCIPAL ORES OF BISMUTH.

THE principal ore, and almost the only source of the metal used in the arts, is **Native Bismuth**, sometimes associated with **Bismuth Glance**,  $\text{Bi}_2\text{O}_3$ ; bismuth ochre occurs in smaller quantities. These ores are generally associated with nickel and cobalt ores.

Bismuth is also found in certain smelting products, such as cobalt speiss for the manufacture of smalt, and speiss and matt obtained from smelting argentiferous cobalt and nickel ores. A certain amount of bismuth is sometimes concentrated in the intermediate products resulting from smelting lead, copper, and silver ores,\* when it cannot be detected in the ores themselves.

#### Synopsis of Processes for the Extraction of Bismuth from its Ores.

Bismuth may be extracted from its ores—

1. By a **Liquation Process**, which is the one most commonly employed. This process consists of heating the ores to  $249^\circ \text{C}$ ., at which temperature the bismuth will melt and run out of the earthy and metallic associates; in this manner bismuth is sometimes obtained as a by-product when purifying cobalt and nickel ores. The methods of liquation adopted in the different smelting works differ chiefly

\* B. u. h. Ztg., 1854, p. 112; 1859, pp. 67, 287, 420. Bgwkfd., iii., 289.

in the construction of the liquation apparatus, which exerts essential influence upon the yield of metal, and on the consumption of fuel. The process may be considered cheap on the whole, and the greater part of the lead which the bismuth ores may contain will remain in the residues; on the other hand, the yield of bismuth is much less than that obtained by smelting in crucibles.

The resulting products are:—

Bismuth, usually containing some lead, nickel, copper, arsenic, iron, and sulphide of bismuth. These impurities make it necessary that the bismuth should be subjected to one of the following treatments:—

*a.* It is again liquated at a low temperature on an inclined plane, and poured into round flat moulds just before it solidifies; sulphide of bismuth, which solidifies sooner than metallic bismuth, becomes separated in a crystalline mass. Schneider\* states that if impure bismuth is poured on a cold plate, the combinations of bismuth with foreign substances solidify first, and pure liquid bismuth breaks from the chilling surface.

*b.* Bismuth may be purified by melting in a crucible, from time to time adding saltpetre whilst stirring it, until a sample taken into the air assumes a green and golden yellow colour on its surface. Blue, violet, and rose-red colours show that the metal is still impure. Fine large crystals of pure bismuth may be formed by covering the crucible with a lid with some coal laid upon it; the surface of the metal bath is thus solidified, and crystals will be left behind on piercing the crust and pouring out the liquid contents.

*c.* Bismuth may be re-melted in iron pans, and the impurities skimmed off.

*d.* It may be cupelled on a cupelling hearth. Oxide of bismuth will be imbibed by the ash of the hearth, from which it may be reduced in a nearly pure condition by smelting the ash together with black flux; such impurities as iron, nickel, &c., will remain on the hearth. Bismuth so purified still

\* Pogg. Ann., Bd. 96, p. 494. Bgwkd., 1855, No. 47, p. 718.



retains small quantities of arsenic, sulphur, and iron, which can be thoroughly extracted only in the wet way.

If bismuth contains a larger amount of lead, or if small quantities of bismuth contained in ores collect in the lead, the separation of both metals may be effected, according to Patera,\* by an oxidising smelting in a cupelling furnace.

Upon cupelling lead containing bismuth, the lead first oxidises, and a greenish black litharge, rich in bismuth, is formed towards the end of the process. Upon reducing this litharge in a small cupola furnace, and re-cupelling the resulting lead, lead will again oxidise and part run off as litharge, whilst part is absorbed by the hearth; the last litharge, which will be green, becomes poorer in lead and richer in bismuth, until at last, bismuth almost free from lead remains on the hearth, which is easily ascertained from samples taken about every half-hour or hour, and assayed by Patera's method in the wet way. 80 per cent of the bismuth treated is extracted in this manner, and contains only traces of lead and iron, and 0.42 per cent of silver. The alloy reduced from the green litharge contains 34.5 per cent of bismuth, and 65.5 per cent of lead.

Vogl† states that bismuth is not more volatile than lead, as the loss of metal, upon cupelling the raw lead of Joachims-thal, always amounts to 7 or 9 per cent, independent of the amount of bismuth contained in the raw lead. Lead containing bismuth does not require so high a temperature for cupelling as pure lead, but it requires a longer time for its oxidation, which is slower and more difficult; whilst  $7\frac{1}{2}$  tons of pure lead may be cupelled in 24 hours, or even less, lead containing bismuth takes three or four times as long.

Litharge containing bismuth has been treated in the wet way—*i.e.*, with muriatic and sulphuric acid, aiming at the formation of insoluble sulphate of lead and a soluble salt of bismuth or volatile chloride of bismuth, but with unsatisfactory results.

**Residues of the Liquefaction Process.**—These are either stirred with water for the separation of a slime rich in

\* B. u. h. Ztg., 1859, p. 287. Oesterr. Ztschr., 1859, p. 175.

† Oesterr. Ztschr., 1862, p. 257.

bismuth, or smelted with fluxes in a reverberatory furnace to extract part of the bismuth. If they contain sufficient nickel and cobalt they are smelted for the production of speiss, which yields bismuth when submitted to the liquation process.

**2. Extraction of Bismuth by Smelting in Crucibles.—**The rise in the value of bismuth to more than one-third that of silver has led in Joachimsthal to a smelting of the ores in crucibles, with an admixture of carbonate of soda, fluor spar, and lime, in order to obtain a better yield than by the liquation process. This method also allows poor bismuth ores containing only 2 per cent to be advantageously treated. The larger yield more than counterbalances the expense of smelting.

Lead is always injurious, and most of it enters the bismuth; plumbiferous ores, poor in bismuth, cannot therefore be treated with profit. On the other hand, cobalt and nickel may be concentrated into a speiss almost without loss.

If the ores contain sulphide of bismuth, and are associated with arsenical nickel and cobalt ores, they require an addition of iron to fix the sulphur and arsenic, as otherwise the volatilisation of bismuth will increase, and the speiss become richer in bismuth; part of the sulphide of bismuth will also remain undecomposed and enter the speiss. If cast-iron be employed instead of wrought iron, more iron will be consumed, owing to the easy fusibility of cast-iron; the speiss will also become richer in iron and poorer in cobalt and nickel.

The results of smelting bismuth ores in a lead cupola furnace, 28 feet high, have been unsatisfactory; the bismuth remaining very liquid and thin at a comparatively low temperature, penetrates the furnace walls and hearth more readily than lead, and a great part of the bismuth remains as furnace ends; the yield is therefore small. The formation of an easily fusible slag necessitates the addition of large quantities of non-metallic basic fluxes, which give rise to a larger loss of metal than is incurred by the lead smelting.

As bismuth oxidises with more difficulty than lead, Patera separates it when smelting litharge rich in bismuth in a

crucible, by throwing pure granulated lead upon the fused litharge, when any silver present will also concentrate in the bismuth.

[www.libtool.com.cn](http://www.libtool.com.cn)

### Illustrations of the Extraction of Bismuth by the Liquefaction Process.

The oldest and most imperfect method of liquation is that performed in open heaps. It consists in placing the ores mixed with some small coal upon a wood foundation, which is then slowly burned. The liquated bismuth is found on the bottom, and is collected, washed, and purified by re-melting.

More recently, the liquation was conducted on hearths similar to those used for liquating lead.

These methods have been superseded by the liquation of bismuth in iron tubes.

FIG. 164.

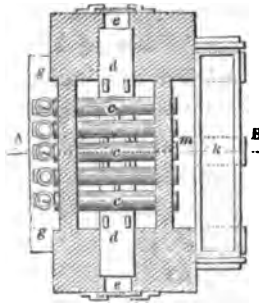

FIG. 165.

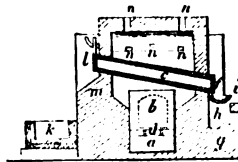
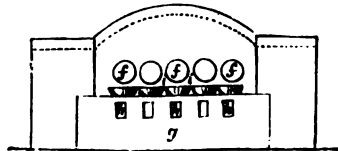

FIG. 166.



The apparatus\* used for this purpose in the metallurgical works at Schneeberg, in Saxony, is represented in Figs. 164, 165, and 166; the first is a bird's-eye view, the second a front view, and the third a transverse section along the dotted line A, B (Fig. 164); *a*, is the ash-pit; *b*, the fire-place; *c*, the liquation pipes; *d*, the grate of masonry or brickwork upon which the fuel is thrown through the fire-door (*e, e*). The deeper lying orifice of the liquation pipes is closed with a clay plate (*f*), which has beneath it a small circular groove, through which the liquefied metal flows; *g*, is a wall extending from the hearth sole nearly to the anterior orifices of the liquation pipes, in which wall there are as many fire holes (*h*) as there are pipes in the furnace; *i, i*, are iron pans which receive the fluid metal; *k*, a wooden water trough in which the bismuth is granulated and cooled; *l*, the higher lying apertures of the liquation pipes, merely closed by a sheet-iron cover. The bismuth to be granulated, after being drained from the posterior openings, falls upon the flat surface (*m*), and then into the water trough; *n, n*, are draught holes in the vault between the two pipes, and serve to regulate the heat.

The ores to be liquated are associated with cobalt and nickel ores, and contain on an average 12 per cent of bismuth. They are sorted from the gangue by hand, broken into pieces about the size of a nut, and introduced into the ignited pipes in charges of about  $\frac{1}{2}$  cwt., so that the pipes are filled to half their diameter and three-fourths their length.

The sheet iron door is shut, and the fire much increased, so that the bismuth begins to flow in ten minutes, and falls through the holes in the clay plates into hot pans containing coal dust. Whenever it runs slowly, the ore is stirred round in the pipes at intervals for half an hour, by which time the liquation is usually finished. The residue, or "bismuth barley," is raked into a water trough with iron rakes, and the pipes are charged afresh; the contents of the pans are cast into moulds, forming bars of from 25 to 50 lbs.

\* URE'S Dictionary of Arts, &c., i., p. 329.

weight. About 1 ton of ore is smelted in eight hours, with a consumption of 63 Leipzig cubic feet of wood.

Plattner has improved this furnace by placing the grate beneath the posterior part of the pipes, and by adding a chimney, and so causing a saving of fuel. Scheerer recommends a gas fire to heat this furnace.

### **Illustrations of the Extraction of Bismuth in Crucibles.**

At Joachimsthal, most of the cobalt and nickel ores contain a small amount of bismuth, which collects in the rich lead and the black litharge, so that its separation may be effected by Patera's method.

A small portion of these ores, containing a larger amount of bismuth, was formerly liquated in a furnace similar to that used at Schneeberg.

Vogl has lately introduced the following treatment of these ores :—

The finely divided ores, containing at the outside 30 per cent, and on an average less than 10 per cent of bismuth, are mixed with 28 per cent of iron chips and old wrought iron in larger pieces, from 15 to 50 per cent of carbonate of soda (according to the amount of silica contained in the ores), 5 per cent of lime, and 5 per cent of fluor spar; 1 cwt. of mixture is charged in a warmed crucible 23 inches high and 16 inches wide. Five per cent of the soda addition is employed as a covering for the mixture, to counteract the volatilisation of bismuth, and the crucible is provided with a lid. The crucible standing upon the grate of an air furnace is surrounded by coal, and as the grate soon becomes obstructed, the door of the ash-pit is closed and the air is admitted by five apertures in the furnace walls above the grate. After having thrown coal into the furnace a second time, the partly fused mass is stirred, and when completely fused it is ladled out (slag as well as speiss and bismuth, according to circumstances) into sugar-loaf shaped moulds, the speiss and bismuth collecting at the point of the mould. The slag, if sufficiently fluid, pure, black, and vitreous, is

nearly free from bismuth. Usually it contains white grains of silica intermixed. The resulting speiss contains 2 per cent of bismuth.

The quantity of soda required to produce a fusible slag is ascertained by experiment. When charging a new lot of ore, sufficient is added, and then deductions are made according to the fusibility of the slag. The carbonic acid escaping from the soda assists the subsidence of the bismuth.

From 2 to 3 cwts. of ore are smelted daily, and one crucible is capable of working only 11 cwts. of ore in 78 hours, when it will be worn out.

## CHAPTER VIII.

### ANTIMONY.

#### PRINCIPAL ORES OF ANTIMONY.

The principal ores of antimony are :—

1. **Grey Antimony Ore**,  $\text{SbS}_3$ , containing 71·4 per cent of antimony. It occurs chiefly in crystalline slate and in primary rocks (Erzgebirge, Hartz, Arnsberg in Westphalia, Magurka in Hungary, Bohemia, France, Spain, Tuscany, Borneo, North and South America, &c.). This antimonial ore is almost the only one found in sufficient abundance for smelting, and it forms the chief and most common source of commercial antimony. At present antimony is not produced in this country, but in the last century it was mined extensively. This ore sometimes contains a small proportion of gold.

2. **Berthierite**,  $\text{FeS, SbS}_3$ , containing 56·67 per cent of antimony. It is sometimes found in large quantities associated with grey antimony.

3. **Oxide of Antimony (Senarmontite)**,  $\text{SbO}_3$ , containing 83·37 per cent of antimony. It occurs abundantly in the province of Constantine in Algeria, and is worked in some French smelting works.

4. **Red Antimony**,  $\text{SbO}_3, 2\text{SbS}_3$ , containing 75·05 per cent of antimony. It occurs abundantly in Tuscany, and is worked, together with grey antimony, in smelting works near Marseilles.

Antimony also occurs with numerous ores of lead, silver, nickel, &c., and is sometimes produced from the intermediate products of these ores.

**SYNOPSIS OF PROCESSES FOR THE EXTRACTION OF  
SULPHIDE OF ANTIMONY (CRUDE ANTIMONY) AND  
METALLIC ANTIMONY (REGULUS OF ANTIMONY)  
FROM THEIR ORES.**

In some smelting works crude antimony is produced from grey antimony ore only by the liquation process, by various methods and with various forms of apparatus. In other works metallic antimony (regulus of antimony) is produced either from crude antimony, or direct from the oxidised or sulphuretted ores.

The processes may therefore be classified as follows:—

**I. PRODUCTION OF CRUDE ANTIMONY.**

The sulphide of antimony liquates from the gangue, which is difficult to fuse at a moderate red heat, and it volatilises considerably at higher temperatures. The liquation is less perfect and the gangue cakes if the ores employed are in the form of schlich, or of smaller fragments than the size of a nut. The residues always retain 10 or 12 per cent of antimony, either as a sulphide, oxide, or oxysulphide. Lamadius directs that the residues should be smelted in admixture with sulphate of soda in a cupola furnace. In Upper Hungary,\* when the price of antimony is high, the liquation slags are worked up.

The liquated crude antimony must cool slowly in order to obtain the required radiated crystalline texture; if it chills suddenly its appearance becomes deteriorated. It usually contains some Fe, Pb, Cu, and As. .

According to Reichardt,† the crude antimony from Schleiz is free from lead, and contains but little iron, and less arsenic than almost all other sorts. Crude antimony, when of radiated structure, contains 0·152 per cent of  $AsS_3$ , and 0·04 per cent of  $AsS_2$  when of granular structure. Crude antimony from Spain contains 0·063; from Rosenau, 0·150; from Wolfsberg (Hartz) 0·235; from East India 0·490; and from

\* B. u. h. Ztg., 1862, p. 408.

† DINGL., Bd. 169, p. 281.



Brandholz (Fichtelgebirge) 0·185 per cent of tersulphide of arsenic. The sulphide of antimony from the Caspari mine at Arnsberg is free from arsenic. Some varieties of Hungarian crude antimony have the following composition :—

	<i>a.</i>	<i>b.</i>
SbS <sub>3</sub> . . . . .	98·330	92·504
AsS <sub>3</sub> . . . . .	0·568	3·403
FeS . . . . .	1·102	4·093

*a.* is from Rosenau, and *b* from Liptau ; both analysed by Löwe.

The liquation of sulphide of antimony is seldom effected direct upon the hearth of a reverberatory furnace, but usually in crucibles or tubes heated either by an open fire or in a reverberatory furnace ; the receiver is placed indifferently inside or outside the furnace. The operations may be short, interrupted, or continuous.

The choice of a method depends chiefly on the richness of the ore, the price of the fuel, and the value of the crude antimony.

Since hard lead has been produced in some smelting works as a by-product, crude antimony has been cheaper.

#### *a.* Liquation of Crude Antimony in Reverberatory Furnaces.

This method involves a small consumption of fuel, but a great loss of sulphide of antimony by volatilisation. It is employed when the mining cost of the ore is low, and when a saving of time and fuel is more an object than a large yield of crude antimony.

At Ramée,\* in the province of Vendée, a small reverberatory furnace is used with a hearth provided with a tapping hole. Charges of 8 or 10 cwts. of moderately rich antimonial ores are made, yielding from 4 to 5 cwts. of crude antimony, at a consumption of 20 cubic feet of wood. A basin to receive the antimony is placed outside the furnace, and communicates with the tapping hole by means of a channel.

\* KARSTEN'S Arch., I R., xviii., 178.

*b.* **Liquation of Crude Antimony in Crucibles.**

This method allows a better yield, but the consumption of fuel is greater, and varies according to the manner of firing, and the length of the operation.

**Liquation in Crucibles in an Open Fire.**—This liquation operation is the most expensive with regard to fuel, and may be used where wood is cheap and the ores are rich and do not require a high temperature. Great quantities may then be produced in larger vessels in a short time, and without such injury to the health of the workmen as occurs when operating with closed furnaces. This liquation may be conducted close to the mine, and the cost of transport saved, so as partially to balance the greater consumption of fuel.

This mode of liquation is adopted in several places: we give three examples:—

1. At Wolfsberg (Hartz).—The simple apparatus in use here is represented by Fig. 167. *a, a,* are the side walls

FIG. 167.

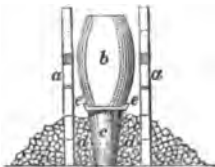

provided with openings for the admission of air. *b,* crucible for receiving the ore, several of which stand side by side; they have pierced bottoms. *c,* lower crucible for receiving the liquated crude antimony. *d,* ash, sand, &c., to enclose the lower crucible. *e,* fire-place.

Grey antimony ore, previously dressed by a hand sorting, is treated. The remaining gangue always contains mechanically some sulphide of antimony, particularly when the ore is too rapidly heated. The residues seldom contain less than one-tenth, and sometimes one-fourth of their own weight of sulphide of antimony.

2. At Malbos\*, in the province of Ardèche. Here the crucibles are conical, and pierced at the bottom; they are

\* DUMAS, *Angew. Chem.*, iv., 146.

0·33 metre high, and 0·22 metre wide on the top ; 25 or 30 of these crucibles stand in a row between the two side walls, 0·25 metre high, with 0·40 metre distance between them. Each crucible contains about 30 lbs. of raw ore. They are placed upon receiving crucibles sunk into the earth ; the space round the upper crucibles is filled with coal, and the coal is ignited by wood shavings. Four smeltings are usually made in 40 hours, by which time the crucibles serving as receivers are filled ; when cooled they are broken in such a manner as to admit of being luted and used again ; but at least half the upper and lower crucibles is lost by each operation.

Twenty crucibles, when charged four times, contain 1 ton 4 cwts. of ore, and yield in 40 hours 938 lbs. of crude antimony, at a consumption of about  $1\frac{1}{2}$  tons of coal and 4 cwts. of wood ; therefore 100 lbs. of crude antimony require for their production 300 lbs. of coal and 40 lbs. of wood rubbish.

3. At Magurka,\* in Lower Hungary, two crucibles, each 11 inches high and capable of containing 8 or 9 lbs. of antimony, are placed one inside the other, and these again in a third crucible, which is surrounded to half its height by ash, &c. About thirty of these compound crucibles are placed in a row between two side walls with a space of 1 foot between each. This space is filled up with thin pieces of dried fir-wood 2 feet long, and the crucibles are covered with a layer of this wood ; the mass of wood is kindled simultaneously by torches. From 4 to  $4\frac{1}{4}$  tons of crude antimony are produced in  $1\frac{1}{2}$  hours, consuming about 880 cubic feet of wood when the weather is fair.

**Liquation in Vessels Standing in Closed Furnaces.**—This method is chiefly adapted for poor ores requiring a higher temperature. Two sorts of apparatus are employed.

*a. Furnaces allowing Interrupted Operations,* having the receivers either inside or outside the furnace.—In either case the liquation vessels must cool after each charge for the residues to be removed.

\* Oesterr. Ztschr., 1856, p. 59. Bgwkfd., xix., 190. B. u. h. Ztg., 1861, p. 123.

At Lincoln,\* in the department Haute-Loire, 75 conical clay crucibles, each 19 inches high, 11 inches wide at the top, and 9 inches wide at the bottom, are placed in a kind of muffle furnace; each bottom is pierced with 5 holes of  $\frac{1}{2}$  inch diameter, and they stand upon crucibles 9 inches high, 10 inches wide at the top, and 8 inches at the bottom, and serving as receivers. Each crucible is charged with 40 lbs. of ore, so that  $\frac{1}{3}$  of rich ore is placed on the bottom, upon this  $\frac{1}{3}$  of ore mixed with gangue, and on the top  $\frac{1}{3}$  of poor ore. A moderate heat is given for an hour, in order to avoid as much as possible the decrepitation of the pieces of ore; next the heat is increased for three hours, and then kept moderate again for the last two hours, to lessen the loss of metal by volatilisation. The receivers then contain 20 or 24 lbs. of crude antimony, which are removed after the furnace has been allowed to cool for from 20 to 24 hours;  $1\frac{1}{2}$  tons of ore consume 15 or 16 cubic feet of birch-wood, yielding about 50 per cent of sulphide of antimony. The waste of crucibles is considerable.

*b. Furnace with continuous Operations.*—This furnace is constructed so as to allow the removal of the residues after each charge, thus causing a considerable saving of time and fuel, and rendering this method more advantageous than other processes.

FIG. 168.

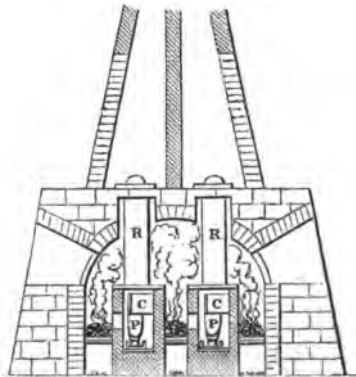

\* KARST., Arch., 1 R. xviii., 158.

The peculiar furnace used at Malbosc,\* in the department of Ardèche, in France, is shown by Fig. 168. The mineral is placed in large retorts (R, R), four of which are set in each furnace. At the bottom of each of these cylinders an aperture is left, corresponding with a similar opening by which they are supported. Beneath these, in the chambers c, c, are placed earthen pots (P, P) into which the melted sulphide descends through the openings in the cylinders. Each cylinder lasts about three weeks, and is charged with 5 cwts. of ore, which are liquated in three hours. The residues are then removed either from the mouth of the cylinders or from an opening which they have on one side, and which is kept closed during the process by means of a clay plug. The liquated sulphide of antimony must flow from the cylinder with a blue flame; a red flame shows that the temperature is too high; 100 lbs. of crude antimony are produced every hour, at a consumption of 64 lbs. of coal; 100 lbs. of ore consume 22 lbs. of coal, the ore yielding 50 per cent of sulphide of antimony.

## II. PRODUCTION OF REGULUS OF ANTIMONY (METALLIC ANTIMONY).

Regulus of antimony was formerly produced from crude antimony, but latterly it has frequently been produced direct from very rich ores. The decomposition of the sulphide is conducted either by combined processes of oxidation and reduction, or by means of iron together with alkaline fluxes. The metal (regulus) resulting from slightly impure ores is usually so impure as to require a calcination for the separation of arsenic, iron, lead, copper, sulphur, &c. The appearance of a star upon the surface of the regulus indicates a certain degree of purity. Rammelsberg says that the star is formed by a great number of rhombohedrons gradually decreasing in size, joined at their edges, and placed in parallel rows, forming three radiated groups from one centre. The alkaline fluxes scorify the earthy and metallic oxides and decompose sulphide of antimony; chloride of sodium

\* KARST., Arch., i. R. xviii., 158.

transforms foreign metals into chlorides, which then enter the slag; and sulphate of soda being reduced when in contact with coal to sulphide of sodium, forms sulpho-salts, which assist scorification. An addition of iron decomposes sulphide of antimony, but part of it enters the regulus. Upon adding some sulphide of antimony during the calcination of metallic antimony, the foreign metals become sulphuretted, entering the slag with the sulphide of sodium.

### Production of Regulus of Antimony from Crude Antimony.

The decomposition of sulphide of antimony may be effected—

1. **By Roasting Reduction Processes.**—If the roasting is conducted carefully, the sulphide of antimony becomes transformed into sulphurous acid and a yellowish white antimoniate of antimony. This antimoniate forms with sulphide of antimony an easily fusible compound, possessing no constant composition, and not losing any of its sulphur by further roasting. The roasted mass (oxide of antimony, antimoniate of antimony, and oxysulphide of antimony), then requires to be reduced. This is effected by smelting it in a crucible, or on the hearth of a reverberatory furnace, for about an hour, after having mixed it with one-tenth of its own weight of raw tartar, or with 1 part of coal and  $\frac{1}{2}$  a part of carbonate of potash. The yield of metal amounts to 65 per cent; it is poured into iron moulds previously brushed over with tallow or loam water.

In Upper Hungary\* the crude antimony, after being crushed and ground, is completely roasted in a muffle furnace in quantities of 3 cwts., yielding 82 per cent of roasted mass. Five cwts. of this mass are mixed with 10 per cent of small coal and from 3 to 6 per cent of sulphate of soda, and smelted in a French antimony furnace (page 545) for about 20 hours. The slag is then removed from the metal bath, and the so-called star slag (from 20 to 25 lbs. of an admixture of 50 per cent of perfectly roasted crude antimony, 2 per cent of

\* B. u. h. Ztg., 1862, p. 408.

powdered coal, 30 per cent of crude antimony, and 20 per cent of carbonate of potash), is added to the metal and smelted. The mass is then ladled into moulds in such a manner that the ingots are covered with slag not more than  $\frac{1}{4}$  of an inch high. This slag separates on cooling, and the metal surface shows a star if the metal does not contain more than 4 per cent of impurities. The resulting regulus is broken, re-smelted with an addition of crude antimony, and refined; the mass is descorified and mixed with some star slag.

**2. By Oxidation by Means of Saltpetre, and by Reduction.**—An admixture of 8 parts of crude antimony, 6 parts of raw tartar, and 3 parts of saltpetre are charged into a red-hot crucible and smelted; the saltpetre forms antimoniate of antimony, which is then reduced by the tartar. This expensive mode yields only 43 per cent.

**3. By Smelting with Iron and Fluxes.**—This method gives a larger yield, but the antimony is ferruginous, and requires calcination. The smelting is conducted in crucibles, in air furnaces, or in small reverberatory furnaces. The decomposition is effected best by spongy iron, which, however, gives rise to the formation of a too ferruginous metal.

A high temperature, causing the volatilisation of a great deal of antimony, is required for smelting, owing to the small difference between the specific gravity of sulphide of iron and antimony, and because sulphide of iron is more difficult to fuse. The volatilisation is prevented by the addition of fluxes (sulphide of sodium, sulphate of soda, and carbon); these combine with the sulphide of iron, forming thin, easily fusible slags, which completely separate from antimony at a moderate red heat. An excess of sulphide of sodium scorifies sulphide of antimony.

Berthier\* states that pure  $SbS_3$  yields from 65 to 70 per cent of antimony, when 100 parts are smelted together with 60 parts of iron scale, from 45 to 50 parts of carbonate of soda, and 10 parts of pulverised coal.

\* KARST. Arch., I R., iv., 261; viii., 285; xi., 39; xiii., 380.

The following method, adopted by Liebig\* and Bensch†, is less expensive, and yields antimony free from arsenic :— 100 parts of sulphide of antimony are smelted together with 42 parts of iron filings, 10 parts of dehydrated sulphate of soda, and from  $2\frac{1}{2}$  to  $3\frac{1}{2}$  parts of carbon ; 16 parts of the resulting regulus are kept in a fused state for an hour, mixed with 2 per cent of sulphide of iron, 1 part of sulphide of antimony, and 2 parts of soda. The regulus is again smelted with  $1\frac{1}{2}$  parts of carbonate of soda, and again with 1 part of soda, till the slag takes a light yellow colour. The extraction of arsenic seems to be effected by the sulphide of iron ; probably a combination is formed similar to arsenical pyrites.

This method is also suitable for purifying the regulus produced by methods 1 and 2 ; 16 parts of impure antimony yield 15 parts of antimony free from copper, arsenic, iron, lead, or sulphur.

Karsten‡ directs that the ores should be dressed, but not liquated, and then smelted in a reverberatory furnace with a hollow hearth ; 2 or 3 cwts. are charged, with 35 or 36 per cent of wrought iron, sulphate of soda, carbonate and chloride of potassium, and coal. After smelting for eight or ten hours, the antimony is tapped off, still being covered with slag. This antimony is re-melted in crucibles containing about 20 or 30 lbs., some carbonate and chloride of potash and coal dust being added.

At Magurka|| from 18 to 20 lbs. of crude antimony are melted in plumbago crucibles with proper fluxes, and the resulting regulus re-melted in the same manner.

**Production of Regulus of Antimony direct from Ores.**—This method has of late been occasionally adopted for working richer ores. According to the richness of the ores the smelting is conducted either in crucibles, or in cupola or reverberatory furnaces, and the sulphide of antimony is decomposed either by iron (London), or by roasting reduction processes (Septèmes, Bouc).

\* ERDM. Journ. f. pr. Ch., ix., 164 ; xliii., 78. Dingl., Bd. 63, p. 446.

† Dingl., Bd. 107, p. 214.

‡ KARST. Met., iv., 544.

|| Oester. Ztschr., 1856, p. 59.



Only very rich ores are smelted in crucibles; these require not so much to be fire-resisting as of such quality as will prevent antimony passing through at lower temperatures.

At the lead works at Enthoven, near London\* (Rotherhithe), antimonial ores containing from 50 to 55 per cent of antimony are smelted in pieces the size of an egg, in crucibles which are manufactured of fire clay, plumbago, and pieces of old crucibles. The ores are put into crucibles heated to a moderate red heat, and a quantity of alkaline slag is charged upon them, and 20 lbs. of old scrap iron placed on the top; the mass is gradually fused, the pieces of iron are pressed into it, and after  $1\frac{1}{2}$  or 2 hours, when completely fused, are poured into conical iron moulds. The crucibles are then re-charged; when cold the contents of the moulds are easily separated into raw antimony and sulphide of iron; the raw antimony is afterwards refined; 10 or 11 cwts. of ore are smelted in twelve hours.

The smelting of antimonial ores is adopted at Septèmes and Bouc, near Marseilles. The ores treated are sulphide of antimony and senarmontite from Constantina, containing 60 per cent of antimony, and red antimony from Corsica and Tuscany, containing from 45 to 55 per cent.

The sulphuretted ores are roasted; the richer and purer ores are afterwards smelted in reverberatory furnaces, and the poor and impure ores treated in cupola furnaces. The roasting is performed with charges of 5 or 6 cwts., in small reverberatory furnaces with an oval hearth and two grates, one on each of the long sides. The furnace is charged and closed, and then moderately heated for two hours; the roasting mass is turned and raked, and roasted for about six hours till no more sulphurous acid is developed. The roasting mass loses from 12 to 15 per cent in weight, including  $1\frac{1}{2}$  or 2 per cent of antimony. It is now smelted in furnaces like those represented by Figs. 169 and 170. The hearth is formed of sand and clay solidly beaten together, and slopes down to the middle, where it is provided with the orifice (*a*), which is closed by dense coal ashes; *b* is the air channel through the

\* B. u. h. Ztg., 1863, p. 328.

FIG. 169.

FIG. 170.

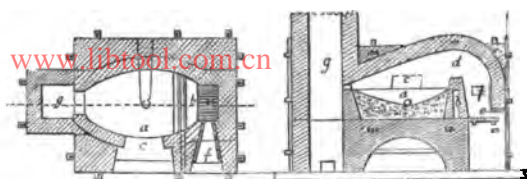

bridge; *c* the door for introducing the prepared ores and running off the slags; *d* the bridge; *e* the grate; *f* the fire or fuel door; *g* the chimney.

The roasting mass is charged in quantities of 360, 400, or 500 lbs., and mixed with 80 or 100 lbs. of fluxes, consisting of chloride of sodium, carbonate of soda, and sulphate of soda, (the two latter in smaller quantities, and sometimes even the sulphate of soda is omitted), 60 or 70 lbs. of small charcoal, and 200 or 300 lbs. of slag of the previous charge. This is first charged and smelted for about one hour, when the other components are gradually added, 40 lbs. every 15 minutes; the mass is continually stirred on the hearth, the resulting froth is skimmed off, and a stronger fire is given towards the end of the process. Metal and slags are then tapped off into an outside basin, from which they are removed when cool. The separated metal is broken into pieces in the order of its calcination. The process is finished in four or six hours, consuming 5 or 6 cwts. of coal, and yielding 42 or 43 per cent of metal instead of 50 per cent. Part of the lost antimony is, however, regained from the smoke, which is condensed in a channel about 350 feet long. The smoke contains as much as 50 per cent of antimony. The common salt strongly attacks the walls and sole of the furnace, probably on account of the formation of volatile chloride of aluminium.

Cupola furnaces yield more than reverberatory furnaces, and the smelting cost is less, but only when treating poor ores which are less amenable to treatment in reverberatory furnaces. At Sèptemes and Bouc poorer ores containing from 30 to 40 per cent of antimony are roasted in a reverberatory furnace; 1 ton of ore consuming in six hours 4 cwts. of coal, with a loss of 12 per cent, including 2 per cent of antimony. From

2 to 2½ tons of roasted ore are smelted in 24 hours at a consumption of from 1 to 1¼ tons of coke, in cupola furnaces with three tuyeres, 3·3 metres high from the tuyeres to the furnace mouth, 0·8 to 0·9 metre deep, and 0·6 metre wide; the furnaces are constructed like channel furnaces with closed eye. The resulting metal, containing from 92 to 95 per cent of antimony, is refined.

### III. PURIFICATION OF RAW ANTIMONY.

This purification is effected by melting the raw antimony, containing copper, arsenic, lead, iron, and sulphur, with oxidising reagents (saltpetre or antimonious oxide), and with purifying reagents (carbonates of potash and soda), in order to oxidise and scorify the foreign metals; or these metals (iron, arsenic, lead, copper) are sulphuretted by a small addition of sulphide of antimony, or Glauber's salts and coal, and are transformed into sulphides, when they combine with the slag. An addition of chloride of sodium transforms these metals into chlorides, and as such they either volatilise or become scorified. Antimonious oxide decomposes sulphide of antimony thus:—



The carbonate of soda reacting as a flux also decomposes sulphide of arsenic, forming carbonic acid, arsenious acid, and sulphide of sodium. Sulphide of sodium fluxes with FeS, Cu<sub>2</sub>S, and As<sub>2</sub>S<sub>3</sub>, whilst the arsenious acid combines with soda. A repeated smelting with soda is required for a complete removal of arsenic, which is facilitated by the presence of a small amount of iron, as a combination similar to arsenical pyrites is formed. Sulphide of iron must be added if the raw antimony does not contain iron. The purifying smelting is effected in crucibles, in reverberatory furnaces, or in air furnaces. In order to furnish the ingots with the star-like appearance on their surface necessary for commerce, the metal must be allowed to solidify under a cover or star slag, and all movement of the moulds must be avoided.

At the Enthoven lead works, near London, the raw metal is sorted according to the amount of iron it contains, which

is judged by the appearance of the fracture. The pieces rich in iron are smelted together with the poor pieces, and 70 or 80 lbs. of this admixture, together with common salt, are kept in a fused state for 1 or  $1\frac{1}{2}$  hours. The smelted metal is poured into hemispherical iron moulds, and broken after the slag has been separated; the pieces are then carefully sorted to obtain a suitable admixture, and purified by being melted in quantities of 60 or 70 lbs., with 1 or 2 lbs. of American potash and 10 lbs. of slags of the same process. After smelting it is stirred with an iron rod, and the state of purification judged by the appearance of the slag. When the slag is lustrous, and of a deep black colour, the metal is poured into moulds, and kept covered with slag until it solidifies. One labourer can turn out from 15 to 17 cwts. of metal in 12 hours.

At Septèmes and Bouc each crucible is charged with 44 lbs. of raw metal, 12 or 16 lbs. of sulphate and carbonate of soda mixed with some common salt, and very pure oxidised antimonial ore. Twenty of these crucibles are kept at a moderate red heat on the hearth of a reverberatory furnace for six hours, consuming 4 or 5 cwts. of coal. The refined metal is poured into moulds, forming ingots 20 or 24 lbs. in weight; the slag is removed after the ingots have cooled.

Many other methods of purification have been recommended. For instance, Wöhler\* heats the metal with 1 part of sulphide of antimony,  $1\frac{1}{4}$  parts of saltpetre, and  $1\frac{1}{2}$  parts of potash, and lixiviates with water for the extraction of arseniate of potash; he then reduces the residue with  $\frac{1}{2}$  part of tartar. Meyer† recommends heating with  $\frac{1}{2}$  part of soda-saltpetre and  $\frac{1}{2}$  part of carbonate of soda, washing with water, and melting the residue with tartar. Schiel‡ recommends the melting of 16 parts of regulus with  $1\frac{1}{2}$  parts of soda, repeatedly adding some saltpetre, and stirring with a clay rod. Berzelius melts 2 parts of metal with 1 part of oxide of antimony. Muspratt melts 4 parts of antimony with 1 part of manganese, and repeatedly melts the resulting regulus with 0.1 part of potash.

\* Pogg. Ann., Bd. 27, p. 628.

† Ann. d. Ch. u. Pharm., Bd. 66, p. 238.

‡ ERDM. J. f. pr. Ch., Bd. 73, p. 189.

## CHAPTER IX.

### NICKEL.

#### PRINCIPAL ORES OF NICKEL.

The principal ores of nickel are—

**Kupfer-nickel**,  $\text{Ni}_2\text{As}$ , containing 43·5 per cent of nickel, and frequently cobalt, iron, and sulphur; sometimes also lead and copper.

**Chloantite**,  $\text{NiAs}$ , containing 27·8 per cent of nickel, and frequently cobalt and iron, sometimes bismuth.

**Nickelspeiss-glance**,  $\text{Ni}_2\text{Sb}$ , containing 31·4 per cent of nickel, and frequently iron, arsenic, and disseminated galena.

**Nickelglance**,  $\text{NiS}_2 + \text{NiAs}$ , containing 35·1 per cent of nickel when pure.

**Antimonial Nickelglance**,  $\text{NiS}_2 + \text{NiSb}$ , containing 27·6 per cent of nickel.

Of less importance are—

**Nickel Ochre**,  $3\text{NiO}$ ,  $\text{AsO}_3$ , containing 29·5 per cent of nickel; **Nickelkies**,  $\text{NiS}$ , containing 64·8 per cent of nickel; and other nickel ores which are sometimes intermixed and worked with the principal ores.

These ores\* occur in Hungary, Erzgebirge, Thuringia, Mansfeld on the Rhine, Silesia, Spain, Norway, Pennsylvania, &c.

\* V. CORTA, *Erzlagerstätten*, ii. V. DECHEN, *Statistik d. zollv. Deutchl.*, i., 774. B. u. h. Ztg., 1861, p. 124; 1863, p. 306. Oesterr. Ztschr., 1855, p. 397; 1858, p. 60; 1858, p. 62. LEOB. Jahrb., 1860, ix., 260.

The ores of nickel found in Great Britain\* are the following :—

**Annabergite, arseniate of nickel**, found at Huel Chance and Pengelly mines in Cornwall; **Emerald Nickel**, said, by Dr. Heddle, to be found on chromate of iron from Swinanness in Unst, one of the Shetland Islands. **Millerite**, sulphide of nickel; this mineral has been found with the Septaria, at Ebbw Vale, in Monmouthshire, at Combe Martin, and at Huel Chance and Pengelly in Cornwall. **Eisen Nickelkies**, sulphide of iron and nickel. This ore has been found in considerable quantities on the property of the Duke of Argyll, near Inverary. Greg and Lettsom give the following analysis of a specimen of the rough ore reduced to powder :—

Iron	. . . . .	43'76
Nickel	. . . . .	14'22
Sulphur	. . . . .	34'46
Silica	. . . . .	5'90
Lime	. . . . .	1'45

**Kupfernichel, Copper Nickel**.—Two or three mines in Cornwall have yielded this ore in some quantities. It has been worked at Huel Chance and at Pengelly. It was found at the Fowey Consols mine. St. Austell Consols produced in 1856 11½ tons; in 1857, 1 ton; in 1858, 1½ tons. Fowey Consols produced in 1853, 3 tons. Rammelsberg gives the following analysis of a foreign variety which corresponds very nearly with some of the English examples :—

Arsenic	. . . . .	48'80
Nickel	. . . . .	39'94
Cobalt	. . . . .	0'16
Antimony	. . . . .	8'00
Silica	. . . . .	2'00

Other ores, for instance iron, copper, magnetic and arsenical pyrites, sometimes contain a small amount of nickel, derived either from disseminated nickel ore or from nickel being isomorphous with iron. Such ores† occur in Dillenburg, Gladenbach, at Klefva in Sweden, Snarum in Norway, Varallo in Piedmont, &c.

\* Dr. URE'S Dictionary of Arts, &c., 1867, iii., 245.

† B. u. h. Ztg., 1856, p. 301; 1858, pp. 304, 353; 1861, pp. 364, 472; 1864, p. 58. Oesterr. Ztschr., 1861, p. 406. Berggeist, 1862, No. 65. Ann. d. Chem. u. Pharm., 1860, Bd. 115, p. 338.

Nickel, moreover, is contained in some smelting products, such as speiss, black copper, slags, lead, litharge, &c. It is frequently present in the liquid metal of Pattinson's process. The ores contain so small an amount of nickel that it cannot be determined by analysis, but it becomes evident in the smelting products.

#### **SYNOPSIS OF PROCESSES FOR THE PRODUCTION OF NICKEL.**

The production of metallic nickel is mostly effected by methods which are partly kept secret. Occasionally nickel is produced from smelting products, and in rare cases only are the ores worked for the direct production of nickel, without a previous formation of speiss or matt.

Sulphides of iron and arsenic are mostly used as reagents for concentrating nickel, and at the same time sulphur and arsenic are employed if copper is to be extracted together with nickel, forming then nickel speiss and copper matt. If the ores of nickel contain a due proportion of copper, sometimes by a judicious combination of the dry and the wet way, an alloy of copper and nickel is produced, instead of metallic nickel.

##### **I. CONCENTRATION SMELTING OF NICKEL ORES.**

This smelting aims at the collection of the nickel in a matt, speiss, or in black copper.

##### **Concentration Smelting of Nickel Ores for the Production of Matt.**

This method is chiefly applied to working sulphuretted ores containing nickel, such as iron and magnetic pyrites. It is based upon the fact that the oxidised iron contained in the roasted ores becomes scorified in great part when submitting the ores, after partly roasting them, to a reducing and purifying smelting with an addition of quartz or siliceous substances. The oxide of nickel which has been formed by the roasting process, and which is somewhat easier to reduce than oxide of iron, thus becomes reduced to metallic nickel, and concentrates in a matt formed of the

undecomposed metallic sulphides, and of those sulphides which have been reduced from sulphates. A slag intermediate between a mono- and bi-silicate, facilitates a perfect separation of the matt. If at the same time the ore contains copper, this metal, owing to its greater affinity to sulphur, is more perfectly concentrated in the matt than nickel. The roasting must be carried on so far as to convert most of the iron into peroxide, which then becomes reduced to protoxide and scorified. If the roasting mass contains too much protoxide of iron, this oxide, when in contact with coal, becomes rapidly reduced to metallic iron, partly entering the matt, or forming iron deposits with a portion of the nickel. The iron may be separated, more and more, by a repeated roasting and reducing smelting of the matt. Reverberatory furnaces are better adapted to the smelting process than cupola furnaces, as the latter are more apt to form metallic combinations (nickeliferous black copper and iron deposits), besides the matt, from which nickel can only be extracted with great difficulty. This disadvantage outweighs the advantage of the quicker concentration of the nickel by the cupola furnace. Stapff\* states that the construction of the cupola furnaces greatly influences the results of this concentration smelting. Furnaces constructed as channel furnaces, with two open eyes (page 91), facilitate the formation of a slag rich in copper and nickel, and of a matt rich in iron, as more reducing gases ascend the furnaces and reduce oxides of copper, nickel, and iron; crucible furnaces (page 90) have proved to be the most economical for these smeltings; more so than sump furnaces.

After being concentrated in a cupola furnace, the matt is submitted to an oxidising blast smelting, in order to extract the iron as perfectly as possible, since its extraction causes great difficulty in the later production of metallic nickel. A concentration of the roasted matt in reverberatory furnaces, with an addition of quartz, heavy spar, or sulphate of soda and some coal, is quite as effective for separating iron, and perhaps more so; besides it causes no loss of copper

\* B. u. h. Ztg., 1858, p. 352.



and nickel in the slag, and no separation of metallic masses (black copper, iron deposits). The coal given in admixture transforms the heavy spar into sulphide of barium, which sulphurises the oxidised copper and nickel present in the mixture, forming baryta; this combines with protoxide of iron and quartz in an easily fusible slag.

When producing nickel from such a matt, a partial separation of the nickel from the other metals is in most cases already induced by a roasting of the matt, thus forming sulphates which are more or less easily transformed into oxides; the transformation of sulphate of iron is effected most readily, that of sulphate of copper less readily, and least so that of sulphate of nickel. The oxides and sulphates are soluble in water and in acids in different degrees. According to Stapff,\* of the free oxides of iron, copper, nickel and cobalt formed by the roasting process, oxide of copper is most easily dissolved in dilute warm sulphuric acid, more difficult is the solution of oxide of nickel, and most of all that of oxide of iron. Cobalt seems to be converted by the roasting partly into  $\text{Co}_2\text{O}_3$ , which renders its solution difficult; part of the nickel also behaves similarly. Zenner recommends heating the metallic sulphides, in order to expel the small amount of arsenic which they may contain, and to extract the greater part of the sulphide of iron by means of dilute sulphuric acid; sulphides of nickel and cobalt are not thus attacked.

#### Illustrations of the Concentration Smelting for the Production of Matt.

At Dillenburg† (Nassau) iron pyrites containing copper and nickel, and composed, according to Schnabel, of

Fe	. . . . .	44.52
Ni	. . . . . (4 to 6 per cent.)	6.13
Cu	. . . . . (5 to 6 „ )	5.39
S	. . . . .	43.96

are roasted in vaulted mounds for four or five days, and then smelted with coke in a channel furnace, with two open eyes,

\* B. u. h. Ztg., 1858, p. 379.

† Ibid., 1860, p. 277; 1864, p. 58. DINGL., Bd. 155, p. 362.

1·4 metres high, 0·55 metre broad, and 0·7 metre deep. If the ores contain a sufficient amount of silica, alumina, and lime to form a suitable slag with the protoxide of iron, they are smelted without the addition of fluxes, otherwise 300 lbs. of ores are mixed with 150 lbs. of slags of the same process, 13 lbs. of limestone, and 6 lbs. of quartz. About 19·8 per cent of raw matt are produced, containing 19 per cent of copper, 13 per cent of nickel, 35 per cent of iron, and 33 per cent of sulphur, besides some slag of the following composition :—

SiO <sub>2</sub>	. . . . .	38·56
Al <sub>2</sub> O <sub>3</sub>	. . . . .	7·16
FeO	. . . . .	35·64
CaO	. . . . .	13·55
MgO	. . . . .	4·79
Cu <sub>2</sub> O	. . . . .	0·58
NiO	. . . . .	trace

The resulting metallic soot is added to later smeltings, and deposits containing 41·5 per cent of iron, if not in too large pieces, are also added to the smelting mixture ; otherwise they are roasted and submitted to an oxidising smelting on a copper refinery hearth, thus yielding a product containing, for instance,—

Fe	. . . . .	20·1
Cu	. . . . .	23·7
Co	. . . . .	2·55
Ni	. . . . .	27·81

After being roasted in mounds three or four times, the raw matt is smelted, together with 200 lbs. of nickel slags and 12 lbs. of roughly pounded quartz to every 300 lbs. of matt, in a channel furnace, for the production of concentration matt, containing from 24 to 25 per cent of nickel, 32 to 36 per cent of copper, 18 to 25 per cent of iron, and 25 per cent of sulphur. The concentrated matt is then for some hours submitted to an oxidising smelting to reduce its iron to 5 or 2 per cent, and its sulphur just enough to keep the matt sufficiently brittle for division. Such a refined matt, used for the manufacture of German silver, contains, for instance, 35 per cent of nickel, 43 per cent of copper, 2 per cent of iron, and 20 per cent of sulphur.

At Gladenbach\* in Hesse, iron and copper pyrites containing 3·4 per cent of copper and 1·7 per cent of nickel is smelted with coke in cupola furnaces for the production of raw matt. This matt is four or five times roasted in mounds and smelted for the production of concentration matt, which is then submitted to an oxidising smelting with coke, a product resulting containing 60 per cent of nickel, some copper, and sulphur. The concentration matt contains, according to Ebermayer, 24 per cent of nickel, 34 per cent of iron, 18 per cent of copper, and 24 per cent of sulphur.

At Klefva† in Sweden, copper pyrites intermixed with nickeliferous magnetic pyrites, containing on an average 1·22 per cent of copper and 3·05 per cent nickel, are smelted in sump furnaces, for the production of raw matt. According to an analysis by Stapff, this matt is composed of 8·57 per cent of nickel, 60·46 per cent of iron, 3·21 per cent of copper, and 25·59 per cent of sulphur. After being roasted three times it is smelted in crucible furnaces, producing concentration matt containing 30·92 per cent of nickel, 31·27 per cent of iron, 12·11 per cent of copper, and 24·48 per cent of sulphur. According to Stapff,‡ the slag was composed of—

SiO <sub>2</sub>	. . . . .	28·09
Al <sub>2</sub> O <sub>3</sub>	. . . . .	3·50
FeO	. . . . .	60·62
S	. . . . .	0·58
CoO, NiO, MnO	. . . . .	1·44

it contained 8·45 per cent of intermixed matt, consisting of 2·97 per cent of iron, 2·42 per cent of nickel, 0·97 per cent of copper, and 2·09 per cent of sulphur.

At Varallo|| in Piedmont magnetic pyrites, containing 5 per cent of nickel, is worked for the production of a saleable matt containing 50 per cent of nickel. The annual production amounts to 50 tons of matt.

\* B. u. h. Ztg., 1856, p. 301.

† Ibid., 1858, pp. 353, 377; 1852, p. 76. ERDM., J. f. pr. Chem., Bd. 53, p. 242; Bd. 54, p. 81.

‡ B. u. h. Ztg., 1856, p. 355.

|| Oesterr. Ztschr., 1861, p. 406. Revue univers., 5 an., 4 livr., p. 186.

**Concentration Smelting for the Production of Speiss.**

If a combination, consisting chiefly of nickel, iron, and arsenic, imperfectly roasted, is submitted to a reducing and purifying smelting, the oxidised iron becomes in great part scorified, the oxidised nickel reduced to metallic nickel, and arseniates, if present, reduced to metallic arsenides (speiss); the nickel then, owing to its greater affinity to arsenic than to sulphur, collects in the speiss. If at the same time the ore contains copper, it will also enter the speiss, but it may be collected in great part in a separate product—a matt,—by adding some iron pyrites to the mixture. The amount of iron may be more completely extracted from the speiss by a repeated roasting and purifying smelting, or by an oxidising smelting, and, according to experiments made at Freiberg,\* this is effected most advantageously by adding some heavy spar (or Glauber's salts) and quartz to the raw speiss; should the speiss contain lead it must undergo a moderate preliminary roasting.

The arsenide of iron seems here to reduce the sulphate of baryta to sulphide of barium, which converts arsenide of copper into sulphide of copper. This sulphide combines with the sulphide of iron, forming copper matt, and separates from the arsenides of nickel and cobalt (speiss), undecomposed by the heavy spar; the greatest part of the protoxide of iron, together with oxide of barium, enters the slag. If the due proportion of heavy spar is added, the resulting matt will be nearly free from nickel and cobalt.

The following substances are chiefly submitted to a concentration by means of arsenic:—

a. Nickel ores, the nickel being chiefly combined with arsenic.

b. Speiss† containing antimony and arsenic, resulting from the silver and copper smelting processes.

c. Smelting products free from arsenic.

Arsenical pyrites,  $\text{FeS}_2 + \text{FeAs}$ , forming, when heated,

\* B. u. h. Ztg., 1849, p. 182.

† Ibid., 1864, p. 323.

$2\text{FeS}$ , and evolving nearly one atom of arsenic (= 46 per cent), is chiefly used for forming the arsenic compounds.

[www.libtool.com.cn](http://www.libtool.com.cn)  
**Illustrations of the Smelting of Arsenical Nickel Ores  
 for the Production of Speiss.**

At Sangershausen\* (Mansfeld), nickel ores, chiefly copper-nickel associated with heavy spar, are smelted without being dressed, in admixture with 1 per cent of fluor spar, 2 per cent of alumina, 4 per cent of quartz sand and slag of the same process, in a sump furnace 6 feet high and 1 foot wide, for the production of marketable nickel speiss. According to Hampe, such a speiss is composed of—

Ni . . . . .	59'72
Cu . . . . .	0'48
Fe . . . . .	0'61
As . . . . .	37'55
S . . . . .	1'90.

1 cwt. of ore consumes about 3·5 cwts. of coal. If, owing to too much iron, the resulting speiss is coarse, granular, and of wavy appearance, instead of fine and granular, the addition of fluor spar must be diminished. At the termination of the operation the resulting furnace ends are smelted, producing an impure speiss containing much sulphur and iron; this is roasted and re-smelted. About 10 tons of ore are worked annually.

At Schladming† nickel ores containing 12 per cent of nickel are smelted for the production of raw matt, which is then melted with richer ores, producing refined speiss.

At Birmingham,‡ Hungarian nickel ores containing 6 per cent of nickel and 3 per cent of cobalt, are more or less moderately roasted according to their composition; afterwards they are raised to a white heat in a reverberatory furnace with an addition of chalk and fluor spar; the slag formed is removed, the speiss tapped off, quenched with cold water, and ground; it is then roasted for 12 hours and worked for the extraction of its nickel.

\* B. u. h. Ztg., 1864, p. 50.

† LEOPEN, Jahrb., 1860, ix., 277.

‡ DINGL., Bd. 111, p. 172; Bd. 112, p. 75. B. u. h. Ztg., 1849, p. 801.

Engelhardt directs that nickel-antimony glance from Camsdorf,\* intimately disseminated with galena, sparry iron ore, and brown iron ore, should be worked on a small refinery hearth for the direct production of speiss, which is then smelted with an addition of lime and loam in a cupola furnace  $4\frac{1}{2}$  feet high, for the production of concentrated speiss.

### Illustrations of the Concentration of Speiss produced by the Copper and Lead Smelting Process.

At Freiberg† speiss resulting from the raw and concentration smelting of lead and copper matt, and containing lead, copper, about 0.5 per cent of silver, and 2.5 per cent of nickel and cobalt, is smelted in admixture with 50 per cent of metalliferous hearth and 150 per cent of baryta slags from the concentration smelting of copper matt; thus producing raw lead, copper matt, and poor argentiferous speiss containing from 15 to 18 per cent of nickel and cobalt. This speiss, after being desilverised, is refined in a reverberatory furnace with an addition of 50 or 60 per cent of heavy spar and from 20 to 25 per cent of quartz, producing a commercial speiss nearly free from iron, and containing from 40 to 44 per cent of nickel and 8 or 10 per cent of copper; some plum-biferous copper matt also results. 18 tons 14 cwts. of nickel speiss were produced in 1861.

At the Lower Hartz‡ a speiss from the smelting of cupriferous lead matt (page 124), had the following composition:—

Cu . . . . .	44.56
Pb . . . . .	26.11
Fe . . . . .	5.54
Ni . . . . .	0.71
Co . . . . .	1.63
Ag . . . . .	0.13
Sb . . . . .	5.21
As . . . . .	12.98
S . . . . .	2.86

\* Bgwkd., ii., 369, 529.

† B. u. h. Ztg., 1864, p. 59.

‡ Bgwkd., ix., 326; xi., 138.

It is submitted to an oxidising smelting in a cupelling furnace, yielding argentiferous black copper, slag, and a dross difficult to fuse. This dross is smelted for the production of copper matt and speiss, and the slag is treated for the production of antimonial lead and speiss; this speiss contains 2 or 3 per cent of cobalt and 0·8 per cent of nickel.

**Illustrations of the Smelting of Intermediate Products (Matt, Slag) free from Arsenic, for the Production of Nickel Speiss.**

This smelting operation is based upon the reaction of arsenical pyrites, with or without an addition of heavy spar, when producing speiss nearly free from iron, copper, and copper matt, and is chiefly applied to products containing copper and nickel. It was first applied in Saxony\* to Dürr ores containing a certain amount of nickel and cobalt, and has been lately patented by Viviant†.

At Altenau‡ (Hartz), a slag containing nickel results from the oxidising smelting of copper produced from furnace ends and residues. This slag has lately been treated for the production of commercial nickel speiss. Hahn's analysis shows it to have the following composition:—

SiO <sub>3</sub> . . . . .	13·607
PbO . . . . .	67·743
Cu <sub>2</sub> O . . . . .	7·125
FeO . . . . .	1·663
NiO . . . . .	2·523
CoO . . . . .	trace
ZnO } . . . . .	0·875
MnO }	
CaO . . . . .	0·915
MgO . . . . .	0·510
Al <sub>2</sub> O <sub>3</sub> . . . . .	3·897
SbO <sub>3</sub> . . . . .	1·371
SO <sub>3</sub> . . . . .	0·027

The slag is sorted into well fused, and imperfectly fused pieces; that in the form of grains is washed to produce schlich

\* B. u. h. Ztg., 1849, p. 182.

† Ibid., 1852, No. 50.

‡ Ibid., 1865, p. 9.

and metallic residues. From these uniform mixtures are formed, which are mixed with 10 per cent of iron pyrites and with an amount of arsenical pyrites gradually increasing from 10 to 40 per cent. The addition of iron pyrites is kept in a constant proportion, and the quantity of arsenical pyrites increased till a speiss results with a fine conchoidal fracture and separating well from the copper matt. If the speiss is reddish, granular, and similar to iron deposits, the addition of arsenical pyrites is further increased.

The following is the most advantageous and generally adopted admixture:—5 tons of slags, 1 ton 1'54 cwts. of arsenical pyrites, 1 ton 12'22 cwts. of iron pyrites, 2 tons 11'59 cwts. of copper matt slags, and 3 tons 14'12 cwts. of lead matt slag; a monosilicated slag is thus obtained. This mixture, smelted in a cupola furnace 8½ feet high (page 106), yields 7'61 cwts. of raw lead containing 0'04 per cent of silver, 1 ton 4'48 cwts. of raw speiss, and 2 tons 11'57 cwts. of copper matt, consuming 30'7 cubic feet of charcoal and 7 tons 15'03 cwts. of coke.

Raw speiss and copper matt are composed, according to Streng, as follows:—

	Speiss.	Matt.
Ni . . . . .	26'77	6'10
Cu . . . . .	19'85	37'24
Fe . . . . .	15'82	20'84
Pb . . . . .	12'14	16'10
As . . . . .	12'15	trace
Sb . . . . .	10'01	0'47
S . . . . .	4'57	19'25

The raw speiss is roasted in heaps three times, chiefly to liquate the lead and oxidise the iron, and then smelted in a cupola furnace with an addition of 5 per cent of arsenical pyrites, 12½ per cent of heavy spar, 50 per cent of copper matt slag, 50 per cent of lead matt slag, and as much impure slag of the same process (about 22 per cent) as is to be had. Five tons of slag yield 3 cwts. of raw lead, 57 per cent of refined speiss, and 40 per cent of copper matt, consuming 10'6 cubic feet of charcoal and 1 ton 18 cwts. of coke; the resulting is between a mono- and sub-silicate.



The speiss and matt are composed as follows:—

	Speiss.	Matt.
Ni . . . . .	35·13	} 4·37
Co . . . . .	1·07	
Cu . . . . .	17·18	37·45
Pb . . . . .	6·59	22·81
Fe . . . . .	8·41	12·68
As . . . . .	18·65	trace
Sb . . . . .	10·82	trace
S . . . . .	2·16	24·48

61 tons of slag yield  $14\frac{1}{4}$  tons of raw speiss, or  $8\frac{1}{2}$  tons of refined speiss,

At Joachimsthal\* the residues resulting from the extraction of silver by Patera's method (page 393) are smelted together with poor silver ores, with an addition of 10 per cent of iron pyrites, 12 per cent of pounded slags, and sufficient lime to produce 16 per cent of matt. This matt is desilverised by extraction, and the residues are smelted in admixture with arsenical and iron pyrites for the production of argentiferous copper matt and raw speiss. This speiss is almost completely liberated from its iron by smelting in a blast reverberatory furnace with an addition of an easily fusible flux.

### Concentration Smelting for the Production of Black Copper or Nickel Deposits.

Sufficient nickel in black copper sometimes concentrates in the uppermost copper disc of the refinery hearth, to make its extraction profitable, especially as nickel is injurious in the refinery process, and deteriorates the quality of the copper. Mica copper, obtained from the smelting of copper residues, contains nickel, as 18(CuO, NiO), SbO<sub>3</sub>, and is sometimes found as oxide of nickel† in small black crystals in the upper copper discs. Alloys of nickel are sometimes produced intentionally in the smelting processes instead of speiss and matt, as they are usually more easily treated, as at Mansfeld, for instance, where they produce nickeliferous copper from slags of the copper refinery process, which is

\* B. u. h. Ztg., 1860, p. 278; 1861, p. 60.

† WAGNER'S Jahrsber., 1860, p. 151.

then treated with sulphuric acid, whilst in Freiberg and Altenau similar products are smelted with arsenical and iron pyrites. [www.libtool.com.cn](http://www.libtool.com.cn)

Tunner considers Chenot's mode of manufacturing iron (*vide* iron) applicable to the extraction of nickel from its ores.

## II. PRODUCTION OF METALLIC NICKEL OR OF COPPER NICKEL ALLOYS.

The different methods for the production of this are partly kept secret, and are based upon the most varied chemical reactions. The dry way is rarely adopted; the wet way is the most general, but occasionally the two methods are combined. If the raw material contains copper, an alloy of nickel and copper is produced, which may be used at once for technical purposes, otherwise metallic nickel is produced.

As copper and nickel possess several qualities in common, for instance, almost the same affinity for oxygen, they can only be separated with difficulty, and not at all by an oxidation smelting.

Nickel approaches most nearly to silver in its nature,\* particularly when alloyed with copper and zinc, but unlike silver, it is not discoloured by sulphuretted hydrogen. A certain amount of arsenic renders nickel and German silver brittle, and causes them to become tarnished when exposed to the atmosphere. Iron and sulphur also render nickel brittle, but the presence of cobalt has a slightly advantageous influence upon its ductility and colour; lead improves the colour of German silver, but increases its brittleness.

Nickel is usually sold in the form of small cubes, and when alloyed with copper, in cakes like refined copper. The cubes are made in the following manner:—Hydrated oxide of nickel produced in the wet way is mixed in a pasty mass with about 5 per cent of rye flour, some beet root syrup, and water. This mass is firmly beaten into a frame, and cubes of 1,  $\frac{1}{2}$  inch, or less are cut out of it; the cubes are then

\* B. u. h. Ztg., 1860, p. 400; 1861, pp. 236, 372; 1863, pp. 304, 439; 1864, p. 91.

quickly dried, without carbonising the flour, and so as not to lose their form by its fermentation.

The dried cubes, in crucibles or tubes surrounded by coal dust, are gradually heated to a strong white heat so as to cause them to cake together, being reduced already at a low temperature. Nickel melts, at about 1900° or 2100° C., with somewhat less difficulty than cobalt. It cannot be fused in the common metallurgical furnaces, but small quantities may be melted in Sefström's furnace. According to Aubel,\* nickel has been fused before the tuyere of a Rchette furnace and in a porcelain furnace†; and Montefiore‡ states that it may be fused in larger quantity in the platinum apparatus contrived by Deville and Debray. Ten per cent of copper and a small quantity of sulphur render nickel fusible in a good air furnace.

Pure nickel, when taken from the reduction vessels possesses metallic lustre; adhering drops of glass indicate the presence of alkali. If the drops are blue, cobalt is present, and if yellow, iron. Black drops, evolving sulphuretted hydrogen gas when moistened, prove that the alkaline sulphide has not been sufficiently extracted previously to the reduction of nickel. Dull looking cubes may be polished by rotating them with water in casks. If the admixture of flour has been too large the resulting metal will appear grey and easily crumble, and have but little lustre. If the temperature employed for caking the metal has not been sufficiently high, a pulverulent or grey spongy mass will be obtained.

The reduction and caking of nickel is effected in crucibles or tubes, in furnaces allowing either continued or interrupted operations. Reverberatory furnaces furnished with vertical tubes are applied for continued operations; the cubes may be removed from the bottom of the tubes, which are then at once re-charged (Liège). The temperature sometimes rises so high as to fuse the nickel, especially if it contains copper; it then runs out of the lower joints of the tubes.

\* B. u. h. Ztg., 1862, p. 392.

† GURLT., Pyrogenet Mineral., p. 13.

‡ B. u. h. Ztg., 1861, p. 236.

The following analyses of nickel and nickel copper are interesting:—

	<i>a.</i>	<i>b.</i>	<i>c.</i>	<i>d.</i>	<i>e.</i>
Ni . . . .	99·57	97·59	97·35	86·90	32·27
Co . . . .	—	0·90	0·85	9·30	—
Fe . . . .	0·20	0·33	0·35	0·21	0·70
Cu . . . .	0·18	0·26	0·25	trace	66·67
Zn . . . .	—	trace	trace	—	—
S . . . .	—	trace	trace	0·22	0·32
SiO <sub>3</sub> . . . .	—	0·92	1·20	1·40	—
CaO . . . .	—	—	—	1·95	—
MgO . . . .	—	—	—	trace	—
C . . . .	0·30	—	—	—	—

*a*, nickel from Iserlohn, by Hofmann; *b*, spongy nickel from Joachimsthal, by Litt and Sturm; *c*, the same in cubes; *d*, nickel produced from Hungarian ores, by Sturm; *e*, older nickel-copper of Dillenburg, by Heusler. The more recent products contain 73 per cent of nickel.

Fleitmann's nickel in cubes costs about 4s. 6d. per lb. Nickel ores, speiss, &c., are bought at Gladenbach according to their contents of nickel at the following prices:—

Ores, &c., containing as much as 5 per cent of nickel at 1s. per lb. per cent.

Ores, &c., containing from 5 to 10 per cent of nickel at 1s. 6d. per lb. per cent.

Ores, &c., containing from 10 per cent upwards of nickel at 3s. per lb. per cent.

### Production of Nickel in the Dry Way.

The different methods in the dry way usually yield more impure and less constant products than the wet way, unless the raw material is very pure. The oldest of these methods\* consisted of a repeated roasting of speiss with coal and wood chips, and reduction of the oxide of nickel. By more recent methods, the speiss is submitted to an oxidation smelting in a reverberatory furnace with an addition of purifying slag fluxes in order to scorify the iron; after separating the iron the oxidation is continued without an addition of slag, thus

\* Bgwkfd., iv., 513.

forming crusts rich in cobalt but also containing nickel ; they are removed till the nickel is sufficiently purified, and are treated in the wet way after exposure for some time to the atmospheric air. Copper cannot be removed by this method.

According to H. Rose,\* nickel free from arsenic may be produced by heating arsenide of nickel with sulphur, so forming sulphide of nickel, whilst sulphide of arsenic is volatilised. Some remaining arsenic may be completely separated by roasting the matt, and treating it again with sulphur. The removal of arsenic may be more quickly effected by fusing arsenide of nickel with seven or eight times the quantity of bi-sulphate of ammonia, thus producing basic sulphate of nickel, and volatilising the arsenic.

The following method has been tried at Dillenburg. The refined matt (page 559) is pounded and roasted as perfectly as possible for fourteen hours at a gradually rising temperature ; it is then treated in quantities of 100 lbs. at a time, with 45 lbs. of soda, in a reverberatory furnace at a red heat for six or seven hours ; the mass is continually stirred to combine the sulphur, which may still remain, with the soda. The sulphide of sodium and sulphate of soda formed are then washed out with warm water, the residue boiled down till dry, and reduced by powdered coal in plumbago crucibles at a white heat maintained for six hours. The resulting alloy is submitted to an oxidation smelting for the extraction of iron, and in order to obtain an alloy of nickel and copper.

This method has offered several difficulties ; the metallic oxides when free from sulphur smelt with great difficulty ; the extraction of iron is not quite perfect, and the slag produced by the oxidation smelting contains copper and nickel.

#### Production of Nickel in the Wet Way.

Ores, matt, and speiss intended for treatment in the wet way for the extraction of their nickel are usually submitted to a previous roasting, for the following reasons:—1st, to make the iron, as far as possible, insoluble (oxide of iron) ; 2ndly, to render the other components (copper, nickel,

\* B. u. h. Ztg., 1863, p. 330.

cobalt) soluble in water, by transforming them into sulphates, or soluble in muriatic and sulphuric acid, by transforming them into oxides or basic salts.

If *matt*, containing iron, copper, nickel, and cobalt, with or without an addition of iron-vitriol, or sulphuric acid, is submitted to an oxidation roasting\* at a gradually rising temperature, the sulphates formed will be decomposed into oxides in the following order:—iron, copper, nickel, and cobalt; sulphate of iron being decomposed by a red heat most easily, and sulphate of cobalt with most difficulty. The greatest part of cobalt and nickel, and some copper, may be extracted from such a roasting mass by water, whilst nearly all the iron, much copper, and a little cobalt and nickel remain. When treating this residue with dilute acids, oxide of copper is dissolved easiest, oxide of nickel with more difficulty, whilst very little oxide of iron is soluble. The roasting seems to transform the greater part of the oxide of cobalt into almost insoluble peroxide. If metallic sulphides still remain, the acids will extract sulphide of iron, whilst sulphides of copper, nickel, and cobalt, will be attacked only slightly or not at all.

If the strongly roasted mass is treated direct with muriatic acid, without previous extraction by water, but little oxide of iron will be dissolved, and more oxide of copper than oxide of nickel; wherefore most of the iron, a little oxide of copper, and much suboxide of nickel will remain in the residue. In such cases, the solution is now and then used for the production of an alloy of copper and nickel, and the residue treated with boiling concentrated acids for the production of metallic nickel (Dillenburg). According to Mitscherlich,† heated oxide of iron is most easily dissolved in a mixture of 8 parts sulphuric acid and 3 parts of water, and the more acid there is present the quicker will be the operation. Very dilute acid has but a slight solvent reaction.

Perfectly roasted *speiss* always retain a small quantity of arsenic, and Liebig‡ states that if mixed with sulphuric acid

\* B. u. h. Ztg., 1860, p. 277.

† ERDM., J. f. pr. Ch., 1860, No. 18, p. 110.

‡ Pogg. Ann., xviii., 164.

to a pasty mass, and heated in a roasting furnace to expel the excess of acid, arseniate of iron, or a basic iron salt and oxide of copper will chiefly remain; whilst, in proportion to the heat applied, sulphates of cobalt and nickel dissolve. Sulphate of cobalt requires a stronger heat for decomposition than sulphate of nickel (*Modum* in Norway). If sufficient iron is not present to fix all the arsenic acid, insoluble arseniates of copper, nickel, and cobalt will be formed; and to avoid this disadvantage an addition of calcined sulphate of iron mixed with 0.1 part of saltpetre is required. It is more judicious to heat the well-roasted speiss with an addition of saltpetre and soda to extract the arsenic, to lixivate the arseniate of soda thus formed, to treat the residue with sulphuric acid, and to extract the sulphates of cobalt and nickel, leaving the oxide of iron in the residue (*Joachimsthal*). *Jung\** states that nickeliferous cobalt ores from *Siegen*, containing arsenio-sulphides of cobalt and nickel, iron pyrites and copper pyrites, behave as though they had been roasted; they are allowed to disintegrate by the operation of the atmosphere, with an addition of chloride of calcium and urine (for facilitating the oxidation). The resulting arseniates of copper, cobalt and nickel are transformed by basic sulphate of iron into vitriols, which may be dissolved out by water, leaving insoluble arseniate of iron.

For the extraction of arsenic, *Wöhler* recommends that the substance should be smelted with an equal weight of sulphur, and three times its weight of carbonate of potash, or twice its weight of carbonate of soda, afterwards lixiviating out the formed sulphates. *Patera* finds it effective to calcine the already roasted substances with an addition of some carbonate of soda and soda-saltpetre, and to lixiviate out the formed arseniate of soda (*Joachimsthal*).

#### Reagents employed to extract Nickel in the Wet Way.

These reagents must be as cheap as possible. The following are those chiefly used:—

1. Carbonate of Lime, as free as possible from iron, is used in the form of pulverised chalk, and the precipitation

\* B. u. h. Ztg., 1861, p. 394.

is usually commenced with it. According to Stapff,\* carbonate of lime precipitates at the common temperature from a solution containing oxides of iron, copper, nickel and cobalt, chiefly hydrated peroxide of iron, with some oxide of copper and a little hydrated oxide of cobalt; when present, acids of arsenic are also completely precipitated with iron as arseniate and arsenite of iron, provided the iron is present in sufficient quantity. If iron is wanting, chloride of iron (made of calcined iron-vitriol and muriatic acid) must be added, to remove the acids of arsenic. The temperature being raised to 40°C. and above, the carbonate of lime after a longer time precipitates the copper, some of the cobalt and nickel, and all the iron; if a solution of a sulphate has been used, a nearly pure solution of nickel results, containing only some cobalt and gypsum. It is therefore possible, by means of carbonate of lime, when employing it at different temperatures, and precipitating fractionally, to separate, first the iron and arsenic, and afterwards the copper, from nickel. If the precipitation takes place at boiling heat, some peroxide of iron will be kept in solution and will precipitate during cooling. A certain amount of protoxide of iron contained in the lime will remain in solution, unless more highly oxidised by an addition of chloride of lime.

Heussler† has ascertained the amounts of nickel and copper in precipitates obtained by fractional precipitations, as follows :—

	<i>a.</i>	<i>b.</i>	<i>c.</i>	<i>d.</i>
Ni . . . .	1'42	1'54	3'67	3'86 per cent.
Cu . . . .	12'30	12'44	13'44	13'44 per cent.

*a*, precipitate obtained from an acid solution at 55° C., before all the iron had been precipitated; *b*, after precipitation of all the iron; *c*, after precipitation of all the iron and copper, at a temperature raised to 70° C., this precipitate being separated the solution was quickly cooled; *d*, the same, except that the precipitate was obtained by a slow cooling.

\* B. u. h. Ztg., 1858, p. 399.

† Ibid, 1860, p. 278.



**2. Solution of Chloride of Lime.**—This is chiefly employed after the iron has been precipitated from a warmed solution by means of carbonate of lime; it transforms the protoxide of cobalt to sesquioxide ( $\text{Co}_2\text{O}_3$ ), and precipitates it completely from neutral solution, as a hydrated oxide of a black or olive green colour. A reddish brown tint of the precipitate indicates the beginning of the precipitation of nickel. In order to obtain pure oxide of cobalt the precipitation must be conducted so carefully as to allow some of the cobalt to remain with nickel; this may usually be done without injuring the nickel.

If any protoxide of manganese is present unprecipitated by carbonate of lime, it becomes transformed into peroxide ( $\text{MnO}_2$ ) by the chloride of lime, and is precipitated sooner than oxide of cobalt; oxide of cobalt containing some manganese may first be separated by a fractional precipitation, afterwards pure oxide of cobalt, and finally oxide of nickel ( $\text{Ni}_2\text{O}_3$ ) with a small proportion of cobalt.

Iron is sometimes precipitated at once at the common temperature by a solution of chloride of lime mixed with lime-water (Louyet's method), instead of carbonate of lime; but this plan incurs the risk of precipitating more cobalt and nickel together with the iron; as much chloride of lime only should be applied as is necessary to transform protoxide of iron into peroxide, and arsenious acid into arsenic acid.

Upon stirring a solution of cobalt and nickel with carbonate of baryta or carbonate of lime, and, at the same time, introducing chlorine gas, cobalt becomes precipitated as black oxide, and also some nickel later on. The precipitated oxide of cobalt must be dissolved in muriatic acid to separate it from admixed carbonates; and the baryta separated by sulphuric acid; the cobalt may then be precipitated from the solution by carbonate of soda or caustic soda.

**3. Lime Water** is used for the precipitation of nickel, or copper and nickel at the same time, after the iron and arsenic have been extracted by carbonate of lime, and the cobalt by chloride of lime.

4. **Carbonate of Soda.**—When employing the before-mentioned lime compounds, and after having dissolved in sulphuric acid, or having formed sulphates by the roasting of matt, there will always be retained in the precipitate of nickel some gypsum, whose extraction is somewhat complicated. In order to avoid this disadvantage, carbonate of soda, although more expensive, is sometimes used to effect the separation of the metals by fractional precipitations. If carbonate of soda is added in small quantities to a boiling solution of peroxide of iron, oxide of copper, oxide of nickel, and a small amount of oxide of cobalt, and continually stirred, a basic salt of peroxide of iron will be first precipitated before the solution becomes neutral; then a mixture of peroxide of iron and oxide of copper, next one of oxide of copper and oxide of nickel, and, lastly, pure oxide of nickel with some oxide of cobalt; the remaining solution usually contains a little oxide of cobalt with a trace of nickel. If acids of arsenic are present they will be precipitated in combination with the peroxide of iron, and if the latter oxide is not present in sufficient quantity arseniates and arsenites of copper, nickel, and cobalt will be precipitated, if the solution is perfectly neutral. An excess of soda has a solvent action upon the precipitated hydrated basic carbonates of cobalt, nickel, and copper.

No nickel is precipitated with the copper so long as 3 or 4 per cent of copper is contained in the solution of nickel.

5. **Sulphuretted Hydrogen Gas** is sometimes used to precipitate copper, lead, antimony, arsenic, and bismuth from their acid solutions; but as the separation of arsenic and iron may be effected by lime, and as an alloy of copper and nickel is an article of commerce, sulphuretted hydrogen gas is usually only applied to separate lead and bismuth when imperfectly extracted by carbonate of soda or carbonate of lime.

6. **Iron** is used for precipitating copper.

7. **Acid Sulphate of Potash** is sometimes used for precipitating nickel from solutions containing cobalt; and nitrite of soda is employed for separating cobalt from solutions containing nickel.

When precipitating by means of carbonate of soda and lime compounds from solutions of sulphates, some sulphates of soda and lime will be formed which cannot be completely washed out of the voluminous precipitate of hydrated oxide of nickel, and which will introduce an injurious amount of sulphur into the nickel, during its subsequent reduction. To avoid this, as far as possible, if sulphate of soda is present, the precipitate of nickel is dried, heated, pulverised and washed with hot water, when the above-named salt will be removed without much difficulty. In case gypsum is also present, the dried precipitate is heated with an excess of carbonate of soda, forming carbonate of lime and sulphate of soda. The sulphate of soda is then washed out with water, and the carbonate of lime is extracted by cold dilute muriatic acid, by which only traces of nickel are dissolved. Gypsum is sometimes extracted by a longer washing with water containing some muriatic acid.

According to Künsel, vessels for holding strongly acid solutions are judiciously coated with *Zeiodolite*, a mixture of one part of sulphur and two parts of finely divided sand.

#### Illustrations of the process of extracting Nickel from Speiss or Arsenical Ores.

Erdmann's older method\* consists in roasting the speiss with coal, dissolving in muriatic acid, and precipitating chloride of bismuth by means of water; a solution of chloride of iron is next added and boiled, whilst gradually adding lime water, and so precipitating arsenite of iron and lime; this precipitation is arrested if the filtrate appears bluish green instead of yellowish green, and if the precipitate produced by an addition of potash solution, yields infusible spongy nickel by fusion with borax and charcoal. The nickel is then precipitated by lime water from the filtrate, and the precipitate dried and heated with coal (page 568).

*Louyet's Method*†, as practised in Birmingham.—The roasted speiss is dissolved in muriatic acid; the oxidised iron com-

\* ERDM. J. f. pr. Ch., vii., 248.

† B. u. h. Ztg., 1849, p. 800. ERDM., J. f. pr. Ch., Bd., 46, p. 244.

bined with arsenic acid, precipitated at the common temperature by an addition of lime water, and chloride of lime; bismuth and copper are precipitated from the acid filtrate by sulphuretted hydrogen gas; the cobalt contained in the solution is precipitated at a higher temperature by chloride of lime, and, finally, the nickel by lime water. Many other methods are based upon this one, which was formerly used in Joachimsthal\* and in Siegen.†

*Ruolz's Method*‡.—Nickel speiss is smelted with an admixture of 20 per cent of saltpetre and 100 per cent of fluor spar, for the scorification of cobalt. The residue is roasted and dissolved in sulphuric acid. The iron is then oxidised by introducing chlorine gas, precipitated at the boiling heat by carbonate of lime, and the nickel thrown down by carbonate of soda. The nickel precipitate is dissolved in muriatic acid, diluted with water, saturated with chlorine gas, and carbonate of baryta is added in excess for the perfect separation of the iron. The nickel may be precipitated from this solution after cooling either in the usual manner as an oxide, or as metal by the galvanic current.

Thompson|| has based a mode of separating nickel from cobalt upon the fact that oxide of cobalt, in the presence of lime, is precipitated by carbonate of ammonia while nickel remains in solution.

Nitrite of potash§ is a suitable reagent for separating nickel from cobalt on a large scale, as it avoids the inconveniences of the application of lime in the wet way. A concentrated solution of nitrite of potash is added to a neutral and concentrated solution of nitrate or sulphate of cobalt and nickel, then some acetic or nitric acid, until the solution becomes somewhat acid, when the cobalt is gradually but almost completely precipitated as a yellow powder, consisting of double nitrite of cobalt and potash, which is heated, and the nitrate of potash formed washed out.

\* B. u. h. Ztg., 1856, p. 122.

† Ibid., 1861, p. 394.

‡ Ibid., 1862, p. 311. Polyt. Centr., 1855, p. 282.

|| Dingt., Bd. 148, p. 206.

§ Pogg. Ann., Bd. 85, p. 496. ERDM., J. f. pr. Ch., Bd. 58, p. 185.

Some nickel containing a little cobalt may be precipitated from the filtrate by carbonate of or caustic soda.

*Cloëz's Method.\**—The roasted speiss is dissolved in concentrated muriatic acid, and bi-sulphite of soda added to convert the arsenic acid into arsenious acid. Arsenic, antimony, copper, lead, and bismuth are then precipitated by sulphuretted hydrogen; iron and cobalt in solution are oxidised by chlorine and precipitated by carbonate of lime or carbonate of baryta. The excess of lime or baryta is removed by sulphuric acid, and the nickel precipitated by an alkaline carbonate.

*More recent Method at Joachimsthal.*—Roasted speiss (page 565) is heated with carbonate of soda and soda saltpetre in a reverberatory furnace, and the formed arseniate of soda extracted. The remaining oxides of iron, copper, nickel, and cobalt are moistened with sulphuric acid, allowed so to remain for some time, and then heated in a reverberatory furnace. The mass is then lixiviated, by which cobalt, nickel, and copper are dissolved, whilst oxide of iron remains. As the iron retains some nickel and cobalt, it is repeatedly moistened and heated with sulphuric acid till it is free from cobalt, which is easily ascertainable by the blowpipe. The solution being acidified with sulphuric acid is treated with sulphuretted hydrogen gas to precipitate the copper; this is filtered off, and acid sulphate of potash is added to the solution, precipitating double sulphate of nickel and potash, which is only slightly soluble; very little cobalt is precipitated. The cobalt remaining in solution is nearly free from nickel, and may be precipitated by carbonate, phosphate, or arseniate of soda. Black oxide of cobalt is formed by gently heating the carbonate.

*Treatment of Cobalt Ores at Modum.*—The cobalt ores from Skutterud (speiss cobalt and glance cobalt) are treated at Modum in Norway for the production of oxide of cobalt and zaffre. The dressed ores (rich and poor mixed together) are roasted in the form of schlich; the pulverised mass is then treated with sulphuric acid, boiled till dry, and freed from

\* DINGL., Bd. 148, p. 206.

the surplus acid in a roasting furnace. The roasted mass is next stirred with water in wooden vessels, and heated to its boiling point by steam; the basic sulphate of iron formed by the roasting process, and also any earthy substances, then sink to the bottom. The liquid is tapped off into vessels standing upon a lower terrace, again heated, and enough carbonate of soda is added to precipitate all the iron and copper and a small quantity of cobalt. The filtered solution is heated for a third and last time, and all its cobalt precipitated by carbonate of soda. The precipitate is filtered, washed, pressed, and strongly heated in clay crucibles; the resulting per- and prot-oxide of cobalt are finely pulverised. One lb. of the oxide consumes about 6 lbs. of sulphuric acid,  $3\frac{1}{2}$  lbs. of soda, and 16 cubic feet of wood.

The first precipitate, containing a little cobalt and very poor schlich, is used for the production of zaffre. For this purpose it is first smelted, producing a speiss containing about 30 per cent of cobalt; this is then submitted to a further treatment.

#### Illustrations of the Processes for the Production of Nickel from Matt.

*Staff's Method at Klefva.\**—The nickel matt is roasted either by itself or with sulphuric acid, then extracted with water, and the residue treated with warm dilute sulphuric acid, by which the reactions, explained on page 571, are induced. The solutions are then decomposed by fractional precipitations with soda (page 573). The different operations of this method are as follows:—

- I. Roasting the matt by itself, afterwards with sulphate of iron and sulphuric acid.
- II. Lixiviation of the roasted matt.
  - I. With water, which yields—
    - A. Residue (2).
    - B. Solution; an addition of carbonate of soda yields—
      - a. A cupriferosus precipitate containing all the iron (2 B).

\* B. u. h. Ztg., 1858, p. 377; 1859, p. 297.

- b.* Solution of nickel, to which carbonate of soda is added, thus precipitating basic hydrated carbonate of nickel contaminated with Glauber's salt; it is dried, pulverised, heated, and boiled with water, and yields—
- a.* Pure oxide of nickel, which is reduced with flour to cubic nickel, and
- β.* Solution of Glauber's salt, which is boiled down for the production of Glauber's salt.
2. With dilute sulphuric acid, yielding—
- A. Residue, used as cobalt ore for colouring purposes.
- B. Acid solution, which is used together with dilute acid for dissolving *1 B a*. It is afterwards boiled with iron, yielding—
- a.* Cement copper, which is dried and refined, and
- b.* A solution of sulphate of nickel and iron, which is boiled down for the production of vitriol; this vitriol is freed from its water and added to *1*.

*Method at Dillenburg.\**—The concentrated matt is perfectly roasted for nine hours in quantities of 300 lbs., and the caked parts sifted off. The roasted mass, in quantities of 100 lbs., is then stirred with water at 60° C., mixed with an equal quantity of muriatic acid of 22° or 23° B. From 60 to 63 per cent of matt is dissolved after the residues have been three times extracted; but little peroxide of iron is dissolved, and copper and nickel in about the proportion of 7 to 3. Most of the iron, a little oxide of copper, and a great deal of oxide of nickel, remain in the residue.

*a. Production of Nickel-Copper from the Solution.*—Oxide of nickel, hydrated oxide of copper, and some hydrated oxide of iron are precipitated by lime water, pressed in canvas bags, dried, ground, and sifted. The precipitate contains about 8 per cent of gypsum, which is washed out by decantation with water containing some muriatic acid; for this purpose 140 lbs. of ground precipitate are washed in a tub four times daily, each time with 4 lbs. of muriatic acid. After four days of this treatment only about 0.3 per cent of sulphur remains. The washing water contains a small

\* B. u. h. Ztg., 1860, p. 277; 1864, p. 58. WAGNER'S Jahrb., 1858, p. 139.

amount of oxide, and is mixed with lime water, and the resulting precipitate used to neutralise the acid solutions. The oxides of copper and nickel liberated from gypsum are dried and reduced to metal in a properly constructed hearth with two tuyeres, by which the lime and nearly all the iron combine with silica, forming a slag. The produced metal sold in this state contains 73 per cent of nickel and only 0.16 per cent of iron.

**b. Production of Metallic Nickel from the Residue.—**

The residue rich in nickel and poor in copper is formed into a paste, with water and mixed with some sulphuric acid of 66° B., which causes the mass to become very hot. It is then extracted with hot water, the residue re-roasted, and treated with sulphuric acid. The resulting solution containing nickel, copper, and some iron is neutralised by the above mentioned precipitate of copper and nickel, and heated to 55° C. Finely divided carbonate of lime is now added, one spoonful after another, and continually stirred till the separation of iron is perfect, which may be ascertained by trying a sample with yellow prussiate of potash; but much copper and some nickel are thrown down along with the iron. To precipitate the copper completely the solution is heated up to 70° C. without an addition of lime, and stirred till prussiate of potash ceases to show any reaction of copper. Analyses prove that most nickel (3 or 4 per cent) is precipitated at the last period of the copper precipitation, and in an increased quantity the more copper there is present; it is, therefore, judicious to extract as much copper as possible by muriatic acid at the first treatment of the matt. After being several times washed and formed with water to a thin paste, the precipitate (page 573) is treated with some muriatic acid (so dissolving copper and nickel and some little iron, which last is precipitated by the excess of hydrated oxide of copper), and copper and nickel are precipitated from the solution by lime water; the precipitate is used for the production of nickel-copper (page 580).

Hydrated oxide of nickel is precipitated by lime water from the chief solution of nickel in sulphuric acid, filtered, pressed, dried, and heated for several hours in order to



render the grey oxide of nickel formed as nearly insoluble in acids as possible. It is then ground, and its gypsum (about 15 per cent) extracted by a treatment for about four days with water acidified by muriatic acid. The oxide of nickel free from gypsum is then formed into cubes and reduced to metal, by heating with coal dust for about three hours at a white heat.

The last residues from the extraction with acid are smelted for the production of black copper and copper matt. This matt, containing 40 per cent of copper, is roasted and smelted for the production of black copper, which requires at its refining an addition of lead to extract its nickel (about 5 per cent).

#### **Illustrations of the Process for the Extraction of Nickel from Refined Copper and Impure Nickel.**

At Gottesbelohnungshütte,\* in Mansfeld, copper produced from the residues of the copper refinery process, containing 63 per cent of copper, 26 per cent of nickel, and 10 per cent of lead, is granulated and treated with dilute sulphuric acid with an admission of air, thus producing sulphates of copper and nickel, which are separated as much as possible by crystallisation; an alloy of copper and nickel is produced from the concentrated sulphates of copper and nickel. Fourteen lead pans, each 3 feet long, 2 feet broad, and 3 inches deep, are placed on terraces one below another, and each half filled with granulated copper (9 cwts.); hot chamber sulphuric acid is then poured into the uppermost pan, and tapped off after two hours into the next pan, and so on. Copper and nickel then become oxidised by the admitted air, and gradually saturate the acid. The slime collecting on the bottom of the pans consists chiefly of sulphate of lead, and is strained off from time to time to separate it from the undissolved granulated copper.

The solution is conducted from the lowest pan into a reservoir for clarifying, and is raised thence by a pump into a heating pan capable of containing 70 cubic feet of liquid; it is here boiled down to 40° or 42° B., and made to crystallise.

\* B. u. h. Ztg., 1859, p. 371; 1860, p. 501; 1861, p. 67; 1862, p. 160; 1864, p. 59.

100 cubic feet of solution yield about 5 tons of copper vitriol, and 65 per cent of mother liquid. This liquid is further boiled down to 7° or 8° B. for the purpose of crystallising sulphates of copper and nickel. One cwt. of granulated copper yields 18·7 cubic feet of raw liquid, containing 1·81 cwts. of copper vitriol, and 0·87 cwt. of nickel vitriol.

The sulphates of copper and nickel are calcined in a small roasting furnace with two hearths, one above the other; the sulphates are extracted, and the residue (chiefly oxide of copper and nickel) is reduced with coal in Sefström's furnace. The resulting alloy is submitted to a smelting with coke on a small refinery hearth furnished with two tuyeres and a sole of plumbago, producing an alloy containing 50 per cent of nickel and 40 per cent of copper; it also contains sulphur, from which it is with difficulty liberated by a repeated roasting with soda.

**Method of purifying Nickel.**—According to Ruolz,\* nickel is dissolved in aqua regia, or in dilute sulphuric acid, in a platinum vessel; chlorine gas is conducted into the solution, the iron precipitated at a boiling heat by carbonate of lime, and afterwards the nickel by soda. As the nickel still retains some iron, the precipitate is re-dissolved and diluted with water. The iron is then oxidised by introducing chlorine gas, and separated by carbonate of baryta. The nickel may be precipitated from the purified solution either by soda or by lime water. The separation of nickel by a galvanic current† has been also recommended.

Deville‡ dissolves commercial nickel in muriatic acid, boils it down till dry, dissolves it in water, by which means oxide of iron remains undissolved; copper, arsenic, &c., are precipitated from the dilute solution by sulphuretted hydrogen gas, and nickel from the concentrated solution by oxalic acid. The oxalate of nickel is heated with the air excluded, and smelted in a lime crucible. The resulting nickel contains 99·6 per cent of nickel, 0·3 per cent of silicium, and 0·1 per cent of copper.

\* B. u. h. Ztg., 1862, p. 311.

† Ibid, 1862, p. 440.

‡ Polyt. Centr., 1858, p. 1302.

## CHAPTER X.

### ARSENIC.

#### PRINCIPAL ORES OF ARSENIC.\*

This metal occurs native in veins, in crystalline rocks, and in older schists; it is found as an oxide, and also combined with sulphur. Arsenic is associated with a great many metallic ores; but in this country it is chiefly extracted from tin ores. Arsenical cobalt is the chief source of arsenic on the Continent.

The following are the principal arsenic ores:—

1. **Native Arsenic**, sometimes containing more or less iron, cobalt, nickel, antimony, and silver, and changing into **Arsenical Antimony**,  $SbAs_{18}$ , containing 92.03 per cent of arsenic. It is found in the silver mines of Freiberg, Annaberg, Marienburg, Schneeberg, Joachimstahl in Bohemia, Andreasberg in the Hartz, Kopnick in Transylvania, Orawitza in the Banat, Kongsberg in Norway, Zimeoff in Siberia, in Alsace, and, according to Dana, at Haverhill, New Haven in the United States.

It is sold either in the state in which it comes from the mine, or, in some cases it is transformed, by roasting, into volatile arsenious acid, for instance, if it contains a certain amount of silver (Andreasberg), or if it is disseminated in other ores.

\* V. DECHEN, *Statistik d. zollv. Deutchl.*, i., 774. URE's Dictionary of Arts, &c., i., 194.

2. **Arsenical Pyrites** (Mispickel),  $\text{FeS}_2 + \text{FeAs}$ , containing 34.4 per cent of iron, 46.0 per cent of arsenic, and 19.6 per cent of sulphur. It occurs in veins, beds, and disseminated in gneiss, mica slate, and serpentine, together with tin ore, wolfram, iron pyrites, fluor spar, &c., in the Bohemian and Saxon Erzgebirge, at Reichenstein, &c.

Arsenical pyrites of the composition  $\text{Fe}_4\text{As}_3$ , containing 32.2 per cent of iron and 66.8 per cent of arsenic, occurs at Reichenstein in Silesia in beds, and disseminated in serpentine and granular limestone. It contains 9 per cent of mispickel. Arsenical pyrites of the composition  $\text{FeAs}$ , containing 72.84 per cent of arsenic, occurs at Reichenstein, Schladming, Andreasberg, &c.; sometimes it also contains gold (Reichenstein, Ribas).

The metallic ores containing arsenic, chiefly cobalt, nickel, and tin ores, are not mined for their arsenic, but this is produced from them as a by-product.

**SYNOPSIS OF PROCESSES FOR THE EXTRACTION OF ARSENIC FROM ITS ORES, AND FOR THE PRODUCTION OF ITS CHIEF CHEMICAL COMBINATIONS.**

Besides metallic arsenic, arsenious acid, and sulphides of arsenic (realgar, orpiment), are chiefly used for technical purposes.

The production of these substances is based upon the great volatility of arsenic and its combinations with oxygen and sulphur, but at the same time this volatility constitutes one of the practical difficulties of the production.

Metallic arsenic volatilises at  $180^\circ \text{C}$ ., arsenious acid at  $185^\circ \text{C}$ ., and sulphide of arsenic at a red heat. Realgar is easier to fuse than orpiment, and orpiment again easier than arsenious acid. When heated, metallic arsenic is at once transformed into gas.

**1. Production of Metallic Arsenic.**

According to Berzelius,\* metallic arsenic occurs in two allotropic modifications. One of them,  $\text{As}_1$ , is produced by

\* Pogg. Ann., Bd. 61, p. 7.

strongly heating arsenic, or by subliming it in vessels, in the receivers of which the sublimate is kept at a temperature nearly as high as that required for volatilising arsenic. This arsenic, deposited in an atmosphere of arsenical gas, is nearly white, of metallic lustre, in crystalline scales, and oxidising but slightly in the atmosphere even at a temperature above  $80^{\circ}$  C. ; it is sold on the Continent by the name of fly powder. It is produced by avoiding the use of too large receivers, and by not cooling them too much.

The other variety,  $As_2$ , is produced by volatilising arsenic in presence of another heated gas (carbonic acid or oxide) and collecting the metal in the less strongly heated parts of the apparatus. This arsenic is crystalline, and of an iron grey colour, oxidising easily in the air, more so at a high temperature. It is called grey arsenic, and is mostly used again in the arsenic smelting works for the production of coloured arsenic glass, &c., its state of aggregation rendering it more fit for such purposes than  $As_1$ .

Metallic arsenic is but little used, and is produced—

a. From arsenical pyrites,  $FeS_2 + FeAs$ , and  $Fe_4As_3$ , which, at a high temperature and exclusion of air, give up the metal, either entirely :—

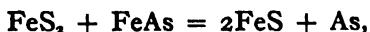

or partially :—

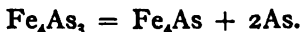

The last particles of arsenic in the latter pyrites cannot be expelled either by sublimation or by a roasting process. At Reichenstein this is a disadvantage in working the residues for the extraction of their gold. A certain amount of sulphur is extracted by an addition of carbonate of potash or burned lime (method in Reichenstein and Spain). Arsenical pyrites of the composition  $FeS_2 + FeAs$ , if heated without the admission of air, yields at first a red sublimate, but afterwards loses the whole of its arsenic.

b. From arsenious acid, by heating it with an admixture of coal, without the admission of atmospheric air.

Pyrites allows only a limited production, and is more

expensive to work than arsenious acid, but its product is of great purity and beauty ( $As_1$ ); if these qualities are of no importance, chiefly if it is immaterial whether the arsenic contains arsenious acid or not, it is better to produce it from arsenious acid; the resulting arsenic ( $As_2$ ) is friable and appears blackish grey, and an intimate admixture of arsenious acid is observable.

Metallic arsenic is produced in gallery furnaces, *i.e.*, apparatus in which vessels for sublimation (tubes, retorts) lie in rows one above another over a fire-grate. These vessels exert an essential influence upon the yield; they must be capable of resisting the influence of the fire, strong enough to bear the weight of the ore charge, and sufficiently dense to prevent any escape of arsenic vapour by the pores. They are best manufactured of an admixture of 1 part fresh clay, and 2 parts old bricks or retorts ground and coated with a mixture of loam, blood, calves' hair, forge scales, and alum; or they may be glazed by being sufficiently dried, brushed with a paste of burned and raw clay, or with pulverised quartz, and then burned.

The retorts being charged with ore, a spirally rolled iron plate for collecting the arsenic is placed in each of their mouths, and receivers fixed to them and luted.

The sublimation vessels are covered by an arched roof furnished with flues, which serve for regulating the fire. The duration of an operation can only be judged by experience; after each operation, the furnace is allowed to cool, the receivers are removed, and the iron plates carefully straightened to avoid injury to the arsenic which has deposited on them.

If the retorts are too wide and too short, a great deal of grey arsenic, with arsenious acid and suboxide of arsenic, are produced, as wide tubes contain too much atmospheric air, and in short tubes the arsenic vapour passes through the spiral iron plate into the receiver filled with atmospheric air, and there becomes partly oxidised. If the retorts are kept too cool, pulverulent arsenic is formed.

### Illustrations of the Production of Metallic Arsenic.

At Reichenstein in Silesia,\* two sorts of arsenical pyrites, occurring in serpentine, are worked. They are composed as follows:—

Fe.	As.	S.	Gangue.
31·51	65·61	1·09	1·04
33·08	45·92	19·26	1·97

The mine produces three kinds of ore, namely, almost pure ore, yielding 45 per cent of arsenious acid; impure ore yielding 20 per cent; and small ore yielding 24 per cent of arsenious acid. These ores are pounded and washed separately, and the resulting schlich of the three sorts, mixed together, yields on an average 30 per cent of arsenious acid.

The furnaces for working these ores have twenty-six tubes or retorts of from 26 to 28 inches in length, and 5 inches in diameter; they are provided with receivers resting upon supports. The rolled iron plate is placed between each tube and receiver in such a manner as to project 4 inches in the tube as well as in the receiver. Thirteen of the twenty-six glazed tubes lie on each side, seven in the lowest row and six above in the intermediate spaces; the receivers are provided in front with a small door of iron plate, which is kept closed till towards the end of the operation, when an observation of the tube is necessary. The furnace roof is provided with openings for the escape of the fume and the flame. The receivers are only fixed to the tubes after the first firing, and when arsenic vapour begins to be evolved. The furnace is charged with 5 cwts. of coarse schlich, and yields in ten hours about 100 lbs. or 20 per cent of arsenic, 90 per cent. of which is sold as fly powder, and 10 per cent as arsenic powder.

The production of arsenic here is not so profitable as the richness of the ore would lead one to anticipate, but it is only possible to expel 20 per cent of the arsenic by a high temperature, and the remaining part is not expelled even by a roasting process. It is therefore difficult to extract the gold

\* KARST., *Met.*, iv., 582, 584. *Ann. d. min.*, 4 sér., xi., 1 livr., 1847, p. 77.

from the residue (*vide* Gold), and the yield is injured. This is also the case with the residues of the production of realgar.

At Ribas, in the Spanish province of Catalonia,\* massive arsenical pyrites with disseminated grey quartz is treated in quantities of 8 or 9½ cwts. in the furnaces represented by Figs. 171, and 172. The twenty-two tubes *a*, *a*, are 27 inches

FIG. 171.

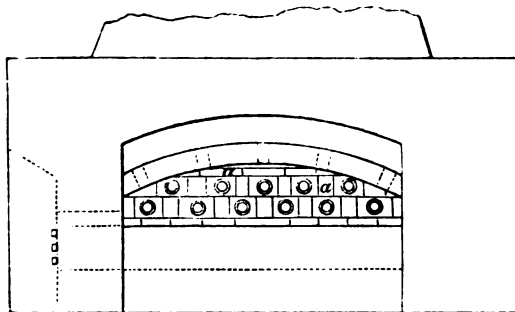
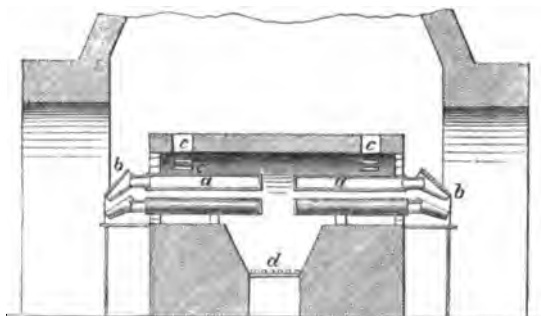

FIG. 172.



long, and 7 inches in diameter; *b*, are the receivers; *c*, the flues; and *d*, the grate. One charge is heated for nine hours, with a consumption of 200 pieces of turf, and about 4 cubic feet of coal, producing 2 cwts. of metal.

At Altenberg in Saxony,† a mixture of 1 cwt. of arsenious acid with about ½ a cubic foot of powdered charcoal is submitted to reduction and sublimation in iron pots. One cwt. of arsenious acid consumes about 8 cubic feet of coal in lumps and 3½ cubic feet of small coal.

\* B. u. h. Ztg., 1853, p. 764.

† DUMAS, *Angew. Chem.*, iv., 110.



## II. PRODUCTION OF ARSENIOS ACID, (WHITE ARSENIC, ARSENIC GLASS).

[www.libtool.com.cn](http://www.libtool.com.cn)

Arsenious acid ( $\text{As}_2\text{O}_3$ , containing 75·81 per cent of arsenic and 14·19 per cent of oxygen) is usually produced as a by-product when roasting arsenical silver, tin, copper, cobalt, and nickel ores (Cornwall, Saxony, Andreasberg on the Hartz); it is seldom produced from arsenical pyrites (Reichenstein).

The following are the principal operations required for the production of arsenious acid:—

1. **The Production of Pulverulent Arsenious Acid (Giftmehl) by Roasting Arsenical Substances.**—The construction of the roasting furnaces employed has great influence upon the quality of the product. Common roasting furnaces, in which the flame of the fuel comes into contact with the roasting mass, yield a product contaminated with carbonaceous substances, causing the reduction of some of the arsenious acid at the subsequent resublimation, and consequently a soiling of the arsenic glass by metallic arsenic. Furnaces for this purpose are constructed like muffle furnaces, the muffle holding the roasting mass and preventing its contact with the flame (Altenberg, Reichenstein, Andreasberg). But as common roasting furnaces consume less fuel, they have lately come again into use, with the precaution of employing fuel which produces little smoke; arrangements are also made to completely burn the smoke; at Ribas gas is used for firing the furnace. Care must also be taken to construct the furnaces so as to protect the workmen from arsenic vapour.

During the charging, the openings communicating with the condensation chambers are closed, to avoid any contamination of the arsenious acid by dust; during the roasting process the roasting mass must be frequently and carefully raked. If the mass contains sulphides they also are volatilised if the temperature is too high; the produced arsenious acid is then liable to yield a yellow or black glass on refining.

The construction of the condensation chambers influences the yield of the roasting furnaces. So-called poison towers are generally used; they are shown in Figs. 173, 174, 175, and 176, which represent the arsenical furnaces at Altenberg.\*

FIG. 173.

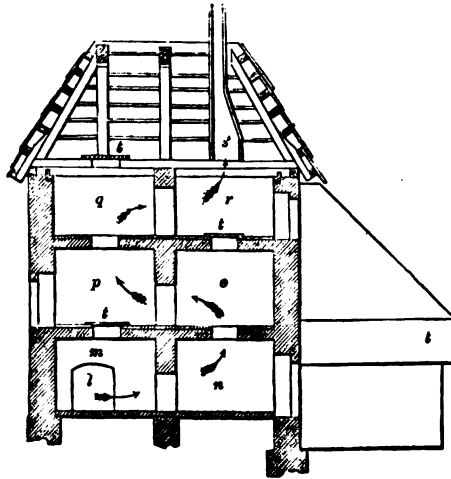

FIG. 174.

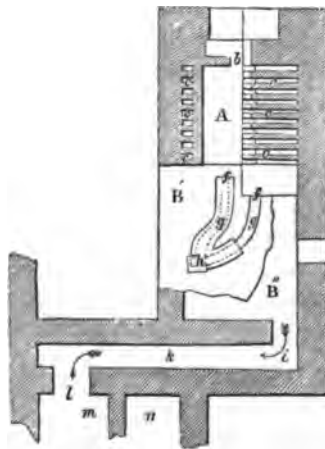
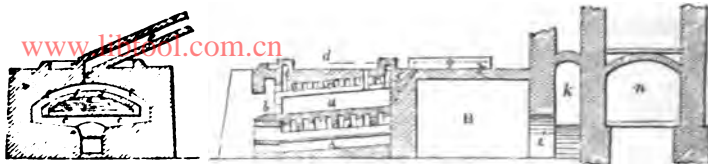

Fig. 173 is a vertical section of the poison tower; Fig. 174 is a longitudinal section of the subliming furnace A, with

\* URE'S Dictionary of Arts, i., p. 195.

FIG. 175.

FIG. 176.



the adjoining vault B, and part of the poison tower at *n*, Fig. 175, is the transverse section of the furnace A of Fig. 174; Fig. 174 represents a ground plan of the furnace A, where the left half shows the part above, and the right the part below the muffle or oblong retorts; B' is the bird's-eye view, B'' the ground plan of the vault B of Fig. 176; *m*, *n*, is the base of the poison tower. In the several figures the same letters denote the same objects; *a*, is the muffle; *b*, the mouth for turning over the arsenical schlich, or ground ore, *c*, *c*, *c*, fire draughts or flues; *d*, an aperture for charging the muffle with fresh ore; *e*, the smoke chimney; *f*, two channels or flues for the ascent of the arsenious fumes; these proceed to other two flues, *g*, both terminating in *h*, which conducts the fumes into the vault, B. They issue by the door, *i*, into the conduit, *k*, thence by *l*, into the spaces *m*, *n*, *o*, *p*, *q*, *r*, of the tower. The uncondensable gases escape by the chimney, *s*. The cover, *t*, is removed on the completion of the process in order to press the sublimate into the lower compartments.

According to Lampadius,\* condensers constructed of a long horizontal shape are preferable, as they allow a more perfect cooling than the towers, supposing the fume travels the same distance in both apparatus. The outer chambers of the tower heat the inner ones, and the middle ones are heated by those lying below and above; the tower is also more difficult to clean from its condensed fume, and its height increases the draught, causing an escape of fume.

In muffle furnaces for roasting, the draught in the tower is but slight, the hot fume moves slowly and does not yield such large crystals as are commercially required, owing to

\* B. u. h. Ztg., 1853, p. 770.

the slow cooling. Horizontal channels and gas reverberatory furnaces make the fume pass more rapidly to the colder parts, and consequently condense them more quickly. Local circumstances usually decide the choice of the condensers. Lampadius recommends horizontal flues provided with water condensation, and Karsten advocates poison towers.

The products of the roasting are—

*a.* **Arsenious Acid**, in the form of a more or less grey powder, which is mostly submitted to a refining, and is rarely sold. The powder from the lower chambers is heavier than that from the upper ones.

*b.* **Residues**, containing the refractory substances of the ore, and arseniates. They are either thrown away (Altenberg), or submitted to a further treatment for the extraction of their gold (Reichenstein, Ribas), or silver (Andreasberg).

**2. The Refining of the Giftmehl for the Production of Arsenic Glass.** This operation consists of a repeated sublimation of the Giftmehl in order to liberate it from mechanically intermixed particles of residues and fuel (Gröbmachen), and afterwards to convert it into a glassy mass (white arsenic glass), this being the form required in commerce.

The sublimation of the pulverulent arsenious acid (Giftmehl), is effected at a moderate and uniform temperature, in cast iron pots or pans surmounted by cylinders of cast or wrought iron, or zinc, thus subliming the arsenious acid whilst the impurities remain in the pan. The top cylinder is furnished with a pipe which terminates in a condensing chamber. If the temperature is too high the mass cakes in the pan, retaining a considerable quantity of arsenious acid; sometimes a high temperature also causes the sublimation of foreign substances, thus counteracting the purpose of the operation. Of the heavier powder from the lower chambers less is charged than that from the upper chambers. If the process is well conducted the arsenious acid deposits in the cylinders, forming a uniform, loose, and friable sublimate; part of the acid which escapes is condensed in the condensation chambers. In some works the sublimed arsenious acid is obtained as crude glass.

In order to avoid loss, the junctions of the pots and cylinders must be well cemented. When, by means of a rod, ore dust only is felt at the bottom of the pot, or when on passing it into the cylinder the rod is no longer coated with arsenious acid, the operation is finished.

The residue is returned to the ore roasting.

The waste of the pots depends on the quality of the cast iron; but the pots are not wasted by the formation of arsenide of iron, as some have stated, only their bottoms, where most exposed to the flame, being burnt. A layer of arsenide of iron, about 0.08 of an inch thick, is formed soon after the first charge, preventing any further action of the arsenic upon the iron beneath.

The sublimed arsenious acid is then again treated in the same furnaces at a higher temperature, causing its deposition in the cylinders as a vitreous mass. Arsenious acid heated in flat or open vessels sublimes and forms crystals, but if heated in deep vessels surmounted with cylinders, the vapours deposit, without sudden condensation, on the sides of the cylinders; these are warmed to a certain degree, and the sublimed acid melts and forms a white glass. The construction of the furnace permits an increase of the mechanical pressure, allowing a stronger heating of the arsenious acid previous to its volatilisation. Better glass is produced in larger quantity the higher the pressure for retaining the vapours of arsenious acid, provided the cylinders are not kept too cool.

The glass sometimes appears of a dark colour; for this no sufficient explanation can be offered. It is erroneously supposed that reducing gases enter the apparatus, reducing arsenious acid, and that the metallic arsenic formed produces the dark colour; remelting this glass renders it perfectly translucent. It is often erroneously supposed that sulphur causes a yellowish tint in the arsenic glass. According to Georgi,\* the glass assumes a yellow colour from an admixture of metallic arsenic or of schlich, which has been carried away together with arsenious acid in the roasting

\* B. u. h. Ztg., 1860, p. 351.

process. To avoid this mechanical volatilisation in the roasting process, it is advisable to close the flue communicating with the condensation chamber, and to open a side flue when charging and stirring the schlich. Georgi also advises the construction of two flues behind the muffle.

Having finished the sublimation and cooled the apparatus, the cylinders are taken off to remove the glass contained in them. Cast iron cylinders are difficult to handle on account of their weight, and the glass sticks rather fast both to them and to cylinders of iron plate; iron cylinders also give a black skin to the glass at the place of contact; zinc cylinders answer better.

The products of this operation are—

*a. White Arsenic Glass*,—amorphous arsenious acid. When fresh it is a perfect glass with a conchoidal fracture, translucent, and with the lustre of glass. After a time this colourless substance becomes white, like porcelain, and of the lustre of opal or wax, without changing its composition or losing its compactness; the amorphous state changes into the crystalline state, the glass at the same time assuming a different hardness, specific gravity, and solubility.

The following analyses of arsenious acid, in form of powder and of glass, show the composition :—

	I.	2.	3.	4.
Arsenious acid . .	90·10	95·85	94·31	98·20
Sulphide of arsenic	2·05	0·32	1·03	—
Bismuth . . . .	—	—	0·25	—
Sulphur . . . .	0·73	0·71	0·50	—
Ore dust . . . .	5·51	2·05	3·05	—
Fume . . . . .	1·04	0·74	0·16	—
Antimonious acid .	—	—	—	1·68

1. Pulverulent arsenious acid from Altenberg, taken from the condenser of a tin roasting furnace, nearest to the furnace, by Lampadius. 2. The same taken from the end of the condenser. 3. The same from Oberschlema, by Lampadius. 4. Arsenic glass from Andreasberg, by Streng.

Bodemann says that pulverulent arsenious acid (Giftmehl) from Andreasberg contains 1 per cent of ferruginous and aluminous lime,  $\frac{1}{2}$  per cent of oxide of antimony, 1 per cent of siliceous residue, and  $\frac{3}{4}$  per cent of moisture.

2. **Sublimate in the Condensation Chambers**; this is either sold as such or converted into glass.

3. **Residues in the Pots**; they are either thrown away, or added to the roasting.

### Illustrations of the Production of Arsenious Acid in Muffle Furnaces.

At Altenberg\* in Saxony, arsenious acid is produced from arsenical pyrites, the massive ore of which yields 95 per cent of schlich; disseminated ore yields 33 per cent, and small mine ore 20 per cent of schlich. The ores are roasted in muffle furnaces. Arsenious schlich, to the amount of from 7 to 10 cwts. for one operation, are spread 2 or 3 inches thick upon the bottom of the muffle, heated to redness by a brisk fire, then exposed to gentler heat, in order before subliming to completely oxidise the arsenical ore; the air must have free access, and the front aperture of the muffle be left quite open. After eleven or twelve hours the calcined materials are raked out at the mouth of the muffle, and fresh materials introduced by the openings indicated above, which are closed during the sublimation. The first schlich yields about 45 per cent of arsenious acid, the second 40 per cent, and the last 33 per cent. The arsenious acid found in the condensation chambers is not marketable, and is sublimed in iron pots, 2 feet 5 inches high and 1 foot 10 inches wide, charging each pot with  $3\frac{1}{2}$  cwts. of arsenious acid. This quantity is sublimed in 12 hours; 15 cwts., which charges four pots, yield  $12\frac{1}{2}$  cwts. of arsenic glass, with a consumption of about 12 cubic feet of coal.

At Reichensteint in Silesia, arsenical pyrites is roasted in a furnace similar to that used in Altenberg. Charges of 8 or 10 cwts of schlich are roasted in 12 hours. One cwt. of schlich consumes 0.07 cwt. of coal. The ores yield from 16 to 61 per cent, on an average 24 per cent of ore schlich, from which is produced from 52 to 70 per cent, on an average

\* DUMAS, *Angew. Chem.*, iv., 106. LAMPADIUS, *Huttenkunde*, ii., 3 Bd. p. 228.

† *Ann. d. min.*, 4 sér., 1 livr., 1847, p. 77. *B. u. h. Ztg.*, 1861, p. 351.

63 per cent, of arsenious acid. A charge of 8 cwts. yields on an average 60 per cent. of arsenious acid, 20 per cent being marketable. The residues, containing from 3 to 5 per cent of arsenic and 0.028 oz. of gold per cwt., are treated by Plattner's method for the extraction of the gold.

The Giftmehl from the last condensation chambers, amounting to 20 per cent of the whole production, is very pure and marketable; that from the other condensation chambers requires a sublimation in the refining furnaces, represented by Figs. 177 and 178. Fig. 177 shows, at A, a vertical section of the furnace, the kettle, and the surmounting

FIG. 177.

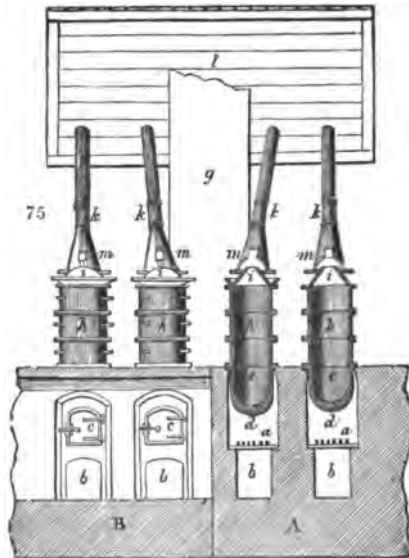
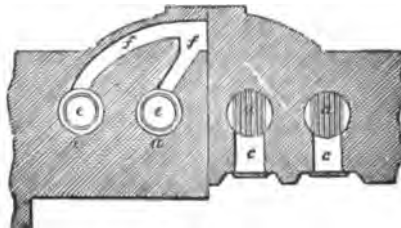

FIG. 178.





drums or cylinders; over B, the furnace is seen in elevation. Fig. 178 is a ground plan of the four fire-places. *a* is the grate; *b*, the ash-pit; *c*, the openings for firing; *d*, the fire-place; *e*, iron pots or kettles which are charged with the arsenious powder; *f*, the fire-flues leading to the common chimney (*g*); *h*, iron cylinders; *i*, caps; *k*, pipes leading to the poison vent (*l*); *m*, openings in the pipes for introducing the probing wires. The kettles are  $27\frac{3}{4}$  inches deep and 19 inches in diameter, and charges of  $4\frac{1}{2}$  cwts. are sublimed in 10 or 12 hours. The poison powder requires two sublimations. 100 cwts. of poison powder (Giftmehl) yield 94.5 cwts. of raw glass and 92 cwts. of refined arsenic glass, at a consumption of 192 cubic feet of coal. The pots wear out in from 16 to 20 days.

At Andreasberg, in the Hartz, arsenious acid is produced from argentiferous arsenic (Scherbenkobalt) as a by-product whilst roasting the arsenic for the extraction of its silver. When in the form of schlich the ore contains about 65 per cent of arsenic,  $4\frac{1}{2}$  per cent of lead, and  $\frac{1}{2}$  per cent of silver, besides calc spar, &c.

The ore is roasted in muffle furnaces, and the arsenious powder collected in a poison tower. From 4 to 6 cwts. are roasted in from 14 to 22 hours, at a consumption of 43 cubic feet of beech wood. The ore is spread out upon the sole of the muffle about 3 inches high, and raked from time to time, but not too often at the beginning of the process. The firing is somewhat increased towards the end of the process, which is finished when no more fume is formed. The fume indicates the state of the process, and when it is just observable at the mouth of the chimney of the poison tower, the process is well conducted.

The residues in the furnace are fused with lead for their desilverisation. The arsenious acid is removed from the poison tower once a year by workmen wearing double tight-fitting clothes, and provided with a moistened sponge to guard their nostrils and mouth.

100 lbs. of arsenical schlich are roasted in  $3\frac{1}{2}$  hours, consuming 9 cubic feet of fuel, and yielding 48 per cent of white arsenious acid, and  $51\frac{1}{2}$  per cent of residues, containing from

1 to 2 per cent of silver, and from 12 to 16 per cent of arsenic. The arsenious acid is sublimed in refining furnaces constructed like those at Reichenstein. Each pot is charged with  $2\frac{1}{2}$  cwts. of powder, and carefully heated so as to sublime the arsenious acid. The proper temperature is ascertained by sprinkling water against the cylinders by means of a broom, and it is suitable if the water on the lower part of the cylinder evaporates with a hissing noise, whilst it gradually evaporates on the upper part. If the temperature is too high, much arsenic sublimes in the condensation chambers, and if too low, a dim glass is formed. If the probing wire, introduced into the cylinder after eight or ten hours' firing, keeps free from a white coating, the process is finished, and the cylinders are emptied on the following day, the arsenious acid forming a crust 1 or 2 inches thick on the sides of the cylinder; a pot lasts for fifty sublimations. The residue in the pot, containing from 40 to 60 per cent of arsenious acid, is added to the roasting. According to Bode-mann, it contains—

- From 63 to 67 per cent of antimony and arsenic ;
- „ 15 to 18 per cent of oxygen, combined with antimony and arsenic ;
- „ 12 to 16 per cent of silica, alumina, lime, and peroxide of iron ; and
- „ traces up to  $\frac{1}{8}$ th of an ounce of silver per cwt.

The sublimate of arsenious acid is partly sold as such, and partly refined, forming raw glass, which is then sublimed in quantities of  $3\frac{1}{2}$  cwts., when it is fit for the market. Five tons of poison powder yield 4 tons 9 cwts. of arsenic glass, 7 cwts. of residues in the pots, and 4 cwts. of sublimate in the condensing chambers; 5 tons of arsenic glass are produced with a consumption of 2,400 cubic feet of beech wood.

#### **Illustrations of the Production of Arsenious Acid in Reverberatory Furnaces with direct Firing.**

These furnaces are advantageous as regards consumption of fuel, but they are seldom used for working real

arsenical ores, and are chiefly employed for roasting such ores as cobalt ores (Schneeberg), silver ores (Freiberg), tin ores (Cornwall, Saxony), when arsenious acid is produced as a by-product.

Fig. 179 shows the construction of a furnace used at Ribas in Spain for working arsenical pyrites. *a* is the

FIG. 179.

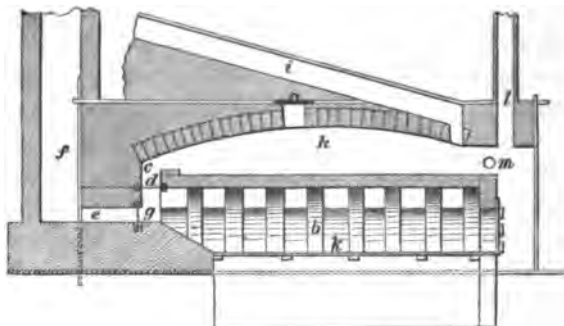

hearth supported by partition walls of bricks, permitting the flame to play against and upon the hearth. When firing with coal, the flue (*c*) is closed by means of the sliding door (*d*), and the flame conducted into the chimney (*f*) by the flue (*e*). When firing with wood, the flue (*e*) is closed by the sliding door (*g*), and the flame is made to pass across the hearth into the flue (*i*), into which the arsenious acid is also conducted; *k* is the grate; *l*, a mantel-piece for receiving any escaping arsenical vapour; *m*, are rollers for supporting the tools.

These furnaces produce a coarser and heavier powder than the muffle furnaces, as their condensation chambers maintain a higher temperature owing to the escaping combustion gases.

#### Illustrations of the Production of Arsenious Acid in Gas Reverberatory Furnaces.

These furnaces consume less fuel than muffle furnaces, and produce arsenious acid free from impurities.

At Freiberg\* the ore dust, containing from 30 to 80 per cent of arsenious acid, collected in the condensation chambers

\* B. u. h. Ztg., 1864, p. 256.

of the roasting furnaces, is worked in furnaces similar to those represented on pages 129, 130, and 131. These furnaces are heated by gas produced by burning coke, and provided with a condensation channel 400 feet long. The ore dust is charged in quantities of 6 cwts. by means of an opening in the furnace roof, and raked from time to time, as it cakes easily. The portion lying before the fire-bridge is roasted in three or four hours; the residue is removed and replaced by the remaining portion from the flue side of the furnace; a charge of fresh ore dust is placed on the flue side. 42 cwts. of ore dust are thus worked in 24 hours, consuming 9 cwts. of coke, and yielding from 65 to 70 per cent of commercial arsenious acid. The residues rich in silver and lead are either smelted together with lead ores, or in admixture with lead slags, and 50 per cent of burned raw matt.

A mixture of arsenical and iron pyrites is sometimes heated in retorts, sulphide of arsenic subliming. The residue is roasted in reverberatory furnaces, yielding sulphurous acid and arsenical fume, which are collected, and the remainder of the roasted mass added to the raw matt smelting.

At Ribas,\* in the Spanish province of Catalonia, the common roasting furnaces before described are used, as well as furnaces heated with gas produced by burning coke, the flame coming into direct contact with the roasting mass.

Comparisons show that a Saxon muffle furnace consumes  $10\frac{3}{4}$  cubic feet of coal per ton of ore; a roasting furnace fed with wood, 81 cubic feet of fuel per 1 ton 4 cwts. of ore; and a gas roasting furnace, 4 cwts. of coke per 3 tons of ore; so that the expenses per cwt. of ore amount for fuel to 3'6d., 7'5d., and 1d. respectively.

15 cwts. of pyrites are roasted in a gas furnace, yielding every six hours as much as 50 per cent of sublimate. The condenser consists of a poison tower in combination with a horizontal channel provided with water condensation.

The sublimate is re-sublimed in three pots 2 feet deep and 1 foot 4 inches in diameter; one charge, consisting of 15 cwts., is finished in eight hours, with a consumption of 3 cwts. of

\* B. u. h. Ztg., 1853, p. 767.

wood and 2 cwts. of coal ; the loss by volatilisation and in the residues is about  $6\frac{1}{2}$  per cent.

Upon refining 12 cwts. of this sublimate in three pots  $11\frac{1}{2}$  cwts. of arsenic glass are produced in seven hours, at a consumption of 4 cwts. of wood and 2 cwts. of coal.

### III. PRODUCTION OF COLOURED ARSENIC GLASS (REALGAR AND ORPIMENT.)

Coloured arsenic glass is frequently produced in smelting works together with metallic arsenic and arsenious acid. These glasses are sulphides of arsenic, namely, the red sulphide of arsenic (realgar), and the yellow sulphide of arsenic (orpiment).

When producing these substances in smelting works, constant chemical combinations are not so much an object as glasses of certain colours, as the price depends on the purity and fineness of the colours.

1. **Realgar,  $As_2S_3$** , containing 70·15 per cent of As and 29·85 per cent of S. All the different methods of producing realgar have in view the combination of metallic arsenic with sulphur in a definite proportion. Such combination may be effected direct by a simultaneous sublimation of suitable ores (arsenical and iron pyrites, as in Saxony), by a fusion of metallic arsenic with sulphur, and a subsequent sublimation of the product (Andreasberg), or by smelting and subliming arsenical pyrites with sulphur (Reichenstein); stöchiometrical calculation shows that when heated with the atmospheric air excluded iron pyrites may evolve about 23 per cent of sulphur—



but the smelting works usually produce no more than 15 or 18 per cent. According to the stöchiometrical proportion, the production of 100 parts of realgar requires 130·4 parts of iron pyrites and 152·1 parts of arsenical pyrites; but in practice equal parts are usually most advantageous.

By themselves arsenic and sulphur are more volatile than when in combination, and this is why the production of realgar by sublimation usually causes less loss than a direct fusion of both substances.

If it were possible to produce a fine red and saleable product by a combination of arsenious acid with sulphur, this product would still be unfit for such purposes as the reduction of indigo, shot manufacture, &c., owing to the presence of arsenious acid; at all events, its adaptability would be less than that of a product produced from metallic arsenic. The production from arsenious acid is also more expensive, as much of the sulphur is converted into sulphurous acid by the oxygen of the arsenious acid, and lost.

The production of realgar requires a closer observation of the stöchiometrical proportions than that of orpiment, and an assay must be made previous to the manufacture on a large scale.

A finer product is usually obtained by sublimation than by mere fusion of arsenic and sulphur. The furnaces for sublimation are similar to those for producing metallic arsenic, save that the rolled-up iron plate is wanting, and the sublimate collects in the receiver. Furnaces like the Belgian zinc furnaces are sometimes used, or even furnaces like the retort apparatus for producing illuminating gas; the ends of the retorts are then contracted so as to collect the product in metal casks by means of a small opening. It is advisable to place the retorts in an inclined position, thus keeping the receivers cooler, and preserving the product collected in them. An inclined position of tubes is less advisable for the production of metallic arsenic, as it is then impossible to raise the temperature high enough to decompose the arsenical pyrites. An opening in the receivers serves for the escape of the formed steam, and for observations of the process; the process is interrupted when the pyrites ceases to burn and to evolve vapours.

The resulting crude glass is usually striped, and requires to be refined to make it homogeneous, and to produce the tint required in commerce more or less sulphur must be added.

Darker glasses require more sulphur than the lighter ones.\* An addition of sulphide rich in arsenic, or of crude glass, is apt to render dark tints lighter. Metallic arsenic is

\* B. u. h. Ztg., 1853, p. 776.

seldom used for this purpose. But authorities differ on this point, and are undecided whether sulphur renders the tint darker or lighter, probably because the artificial realgar is not a constant sulphide, but a mixture of different combinations with uncombined sulphur. Actual chemical combinations of arsenic and sulphur are lighter in colour the more sulphur they contain.

The re-melting of the raw glass is effected in cylinders of iron plate, which are placed in a highly inclined position, or in cast-iron pans. After the melting, the manipulations are, stirring the fused mass, skimming it, adding sulphur, arsenic, or crude glass, and taking samples by dipping a cold iron rod into the fused mass; the crust formed on the rod shows the colour of the glass. The liquid is then heated so strongly as to become very fluid, and is then poured into moulds, which may be covered by iron plates.

Good realgar is orange yellow, changing into hyacinth red and brown. It is pellucid and more easily fusible than yellow sulphide of arsenic. It volatilises at a temperature below red heat.

2. Orpiment,  $\text{As}_2\text{S}_3$ , containing 61.04 per cent of As and 38.96 per cent of S. This product is mostly produced by melting arsenious acid with sulphur, or by subliming these substances. Weathered arsenical pyrites, containing this substance, are sometimes employed instead of arsenious acid—

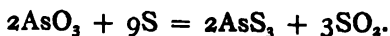

Usually pulverised arsenious acid and sulphur are melted and sublimed in the apparatus used for refining *Giftmehl*. After having obtained the desired colour in small samples by a variation of the constituents, the mixture is made for the production on a large scale. It must be taken into consideration that the beauty of the colour decreases if the substances are mixed in the stöchiometric proportion, namely 100 parts of arsenious acid and 73 parts of sulphur. A much smaller quantity of sulphur (one-third or one-fifth) produces a fine yellow colour. Usually 100 parts of arsenious acid are mixed with from 14 to 17 parts of sulphur.

Lampadius\* employed from 2 to 20 per cent of sulphur, and obtained tints slightly varying, independent of whether more or less sulphur was lost as sulphurous acid. He therefore concluded that the yellow tints were produced by a small quantity of sulphide of arsenic, either mechanically dissolved in arsenious acid or chemically combined with it. Experiments to combine from 1 to 4 per cent of realgar with arsenious acid, confirmed his conclusion, as those combinations formed the most beautiful orange or citron yellow glasses.

The usual method of producing orpiment is to carefully heat a mixture of arsenious acid and sulphur at a gradually rising temperature (up to red heat) until the formed vapours melt in the cylinders to a vitreous mass. If the temperature is too low, a great deal of pulverulent orpiment will result, and if too high, much vapour will escape without becoming condensed. The firing is interrupted when a bright iron introduced in the cylinder does not become much coated. The glass is removed from the cylinders after cooling; it is usually deposited in three layers, namely, a fine yellow glass, a striped glass, and a yellow powder.

The yellow glass is a commercial article, and is invariably a mixture of arsenious acid and sulphide of arsenic.

Re-melting renders the striped glass homogeneous; the yellow powder is added to the next sublimation.

According to Winkler and Thiel, commercial orpiment contains up to 97 per cent of arsenious acid when of light colour; the darker sorts contain from 1 to 15 per cent.

### Illustrations of the Production of Realgar.

#### A. Production of Realgar from Iron and Arsenical Pyrites.

In the Saxony arsenic works, equal parts of iron pyrites and arsenical pyrites are gradually heated to redness in the clay retorts of a furnace similar to that represented by Figs.

\* B. u. h. Ztg., 1853, p. 778.





171 and 172 (page 589). The sublimed sulphide of arsenic is collected in cylindrical receivers provided with an opening  $\frac{1}{4}$ th of an inch square for the escape of steam, &c. These receivers are not cooled by artificial means. After firing for ten or twelve hours the furnace is gradually cooled, and the sublimate removed from the receivers; the sublimed sulphide of arsenic is then refined by re-melting, either in inclined cylinders, or in cast-iron pans, at a temperature quickly rising up to a red heat. Care must be taken that the flame does not reach the mouth of the vessel, as this would cause the ignition of the sulphide of arsenic. The impurities are skimmed off the fused mass, and samples taken from time to time by means of an iron rod. If necessary, an addition of sulphur, arsenic, or of sulphide of arsenic, with an excess of arsenic, is given whilst continually stirring the mass. An addition of sulphur is preferred to one of arsenic, so that the production of a compact darkish product, which requires an addition of sulphur, is aimed at in the sublimation. The sublimate being pulverulent, friable, and light red, necessitates an addition of arsenic.

If the glass flows thin from the iron rod, and is compact after cooling, and of the desired colour, the liquid mass is run into iron plate moulds and allowed to cool, the moulds being covered by a lid. The cooled ingots are broken into pieces and sold as such.

At Ribas\* mixtures of equal parts of arsenical and iron pyrites, in quantities of 8 cwts., are heated in retorts. They consume in six or seven hours 2 cwts. of wood and 3 cwts. of coal, and yield  $1\frac{1}{2}$  cwts. of glass, which is re-melted in pans 2 feet 6 inches and 3 feet long, 1 foot and 1 foot 3 inches broad on the bottom or top respectively, and 2 feet 3 inches high. A charge of 4 cwts. of raw glass is refined in two hours. Such a charge of the darker sorts requires an addition of from 40 to 50 lbs. of sulphur, and of the lighter sort an addition of 30 lbs.

\* B. u. h. Ztg., 1853, p. 774.

### B. Production of Realgar from Arsenical Pyrites and Sulphur.

At Reichenstein, an admixture of 5 cwts. of arsenical pyrites in the form of coarse schlich, and 78 lbs. of raw sulphur, is heated in retorts, producing  $1\frac{1}{2}$  cwts. of raw glass. This is refined in cast-iron pans in quantities of 4 cwts. with an addition of about 60 lbs. of refined sulphur, yielding about 4 cwts. 27 lbs. of realgar. When roasted, the residues in the retorts still yield about 35 per cent of arsenious acid.

### C. Production of Realgar from Arsenious Acid and Sulphur.

At Andreasberg, experiments were made to produce realgar by a fusion of native arsenic with sulphur, and a product of more or less fineness was always obtained. These experiments also showed that the following rules were to be observed for the production of a good glass.

*a.* The arsenic must be employed in a state of fine division, to hasten its speedy combination with sulphur, which may be employed in a coarser form.

*b.* The re-melted realgar must be quickly cooled in cold moulds, otherwise it becomes striped; and

*c.* The realgar, especially when in a pulverulent state, must be protected from the light, which gives it a violet tint.

At Reichenstein, Georgi fused some best refined sulphur in a flat iron pan, at a temperature below  $120^{\circ}$  C., and added metallic arsenic whilst continually stirring the mass. He then covered the pan and gradually raised the temperature till the mass was uniformly fused. The resulting product was good, but unfit for sublimation, as it yielded different sublimates one after another; there first resulted sulphur and yellow sulphide of arsenic; afterwards a sulphide of arsenic rich in sulphur, of a brilliant ruby red colour; and lastly an almost black combination rich in arsenic.

### Illustration of the Production of Orpiment.

At Reichenstein, arsenious acid is carefully heated with 5 per cent of pulverised sulphur, at a temperature gradually rising up to redness, in refining pots, such as are used for

refining arsenic glass. The evolved vapours of orpiment are made to condense in the cylinders, when they form a glass. If the temperature is too high, much of the vapour will escape, and if too low, the resulting product will assume the form of powder. The process is interrupted if an iron rod introduced into the cylinders does not become coated. The glass is removed from the cylinders after cooling and sublimed again ; the resulting glass is now broken into pieces, sorted, and the inferior pieces added to the next mixture for sublimation.

## CHAPTER XI.

### GOLD.

#### PRINCIPAL ORES OF GOLD.

GOLD is chiefly found in the metallic state, sometimes crystallised in cubes and its derivative forms. It also occurs in threads of various sizes, twisted and interlaced into a chain of minute octahedral crystals, and in spangles or rounded grains, which are called nuggets when of a certain magnitude. The small grains are not fragments broken from a greater mass, but show by their flattened ovoid shape and their rounded outline that this is their original state. Humboldt states that the largest nugget known was one found in Peru, weighing about 26 lbs.; but masses from the province of Quito have been stated to weigh nearly four times as much, and some of the nuggets from Australia have greatly exceeded it.

Native gold is never free from silver, and frequently contains small quantities of iron, copper, mercury, palladium, platinum, iridium, &c.\* According to Boussingault,† gold from South America contains from 11 to 35 per cent of silver, and according to Rose,‡ gold from Siberia and Transylvania from 4 to 38 per cent of silver, and from 0·1 to 0·4 per cent of

\* Bgwkfd., xxi., 66. Polyt. Centr., 1854, p. 885. B. u. h. Ztg., 1851, p. 729; 1860, p. 178; 1862, p. 275. ERDM., J. f. pr. Chem., lxi., 435. COTTA, Erzlagerst., i., 59; ii., 589.

† Ann. d. Chem. et de Phys., xxxiv., 408.

‡ B. u. h. Ztg., 1860, p. 498. Pogg., xxiii., 161, 196.

copper and iron. Henry, Teschemacher, Oswald, Hofmann, and Rivot found gold from California\* to contain from 6 to 10 per cent of silver, and Thomas and Kerl found from 3·5 to 6·9 per cent of silver in gold from South Australia.†

The following rare minerals are compounds of gold:—

**Tellurides of Gold.**‡— $\text{AgTe}_3 + \text{AuTe}_3$ , containing 26 per cent of gold, and  $2(\text{Pb,Au})_3(\text{S,Te,Sb})$  containing from 6·5 to 8·5 per cent of gold.

Gold is most frequently found in the native state, or in combination with metallic sulphides, namely, iron, arsenical, and copper pyrites, zinc blende, galena, sulphides of antimony, silver, &c. The hypothesis has been suggested that part of the gold in iron pyrites does not exist in a metallic state, but is combined with sulphur, or with arsenic in arsenical pyrites. The ores have been supposed to contain less gold the deeper they occur beneath the earth's surface; but later experience proves this supposition to be wrong. The mineral formations|| in which gold occurs are the crystalline primitive rocks, the compact transition rocks, the trachytic and trap rocks, and alluvial grounds. In his chapter *On the Original Formation of Gold in Siluria*, Sir Roderick Murchison says:—"We may first proceed to consider the nature and limits of the rich gold-bearing rocks, and then offer proofs that the chief auriferous wealth, as derived from them, occurs in superficial detritus. Appealing to the structure of the different mountains which at former periods have afforded, or still afford, any notable amount of gold, we find in all a general agreement. Whether, referring to past history, we cast our eyes to the countries watered by the sources of the Golden Tagus, to the Phrygia and Thrace of the Greeks and Romans, to the Bohemia of the Middle Ages, to tracts in Britain, which were worked in old times, and are now either abandoned or very slightly productive, or to those chains in America and Australia which, previously unsearched, have in our times proved so rich, we invariably

\* LIEBIG'S Jahresber, 1849, p. 716.

† Ibid., 1851, p. 754.

‡ B. u. h. Ztg., 1859, pp. 140, 267.

|| URE'S Dictionary of Arts, London, 1867, vol. ii., 495.

find the same constants in nature. In all these lands gold has been imparted abundantly to the ancient rocks only whose order and succession we have traced, or their associated eruptive rocks. Sometimes it is also shown to be diffused through the body of such rocks, whether of igneous or of aqueous origin. The stratified rocks of the highest antiquity, such as the oldest gneiss and quartz rocks (like those, for example, of Scandinavia and the northern Highlands of Scotland), have very seldom borne gold; but the sedimentary accumulations which followed, or the Silurian, Devonian, and carboniferous (particularly the first of these three) have been the deposits which, in the tracts where they have undergone a metamorphosis or change of structure by the influence of igneous agency, or other causes, have been the *chief* sources whence gold has been derived."

The principal gold mines at present are the Californian and Australian.

1. The Californian Gold Mines; these are excellently described in Professor Blake's remarks on the "Geognosis of the Gold Drift in California," from which we give the following extract\* :—

"With the exception of the diluvial strata, the whole geological formation of the Sierra range consists of igneous and metamorphic rocks; the former are mostly porphyritic in the lower hills, whilst higher up trachytic rocks are more frequently met with. The metamorphic rocks consist of micaceous schists, slates both talcose and micaceous, metamorphic sandstones and limestones, with occasional beds of conglomerate. The stratified rocks have been much displaced; it is rare to find them with a dip of less than 70°, and they are generally very nearly perpendicular. The strike of the beds in that section to which Professor Blake's observations have been confined (between the Stanislaus and Yuba rivers) is extremely uniform, being from 5° to 10° W. of N. and E. of S. The extent of the diluvial deposits is commensurate, or nearly so, with that of the gold-bearing

\* URE'S Dictionary of Arts, &c., ii., p. 501.

region in that part of the country which he has examined. They are found in a belt of land from 30 to 60 miles broad, and running parallel with the axis of the range; and, from facts that he has ascertained from others, he states that he has no doubt but that they exist throughout all the gold bearing region both north and south. These diluvial deposits are met with as we advance towards the lower hills of the Sierra, extending frequently some miles into the plain. On ascending from the lower hills towards the mountains, the diluvial beds no longer occupy the same relative position: occasionally deposits of rounded stones can be found in the valleys and on the sides of the hills; but when this is the case, their origin can be traced to deposits on the tops of the surrounding hills, from which they have been brought down by the action of the causes now at work. As we ascend towards the axis of the chain, these deposits become more extensive, and at a distance of 20 or 30 miles from the lower hills they are found occupying the crests of almost all the ridges in the country; but besides being found on the crests of the ridges, where their extent frequently does not exceed a few yards in breadth, they are also met with covering the extensive elevated flats which exist on the benches between the different water-courses, forming continuous beds of some miles in extent, which are rarely interrupted by the protrusion of any of the older rocks. Where found in elevated situations, the lower hills and valleys are entirely free from them; frequently a large section of the country will be enclosed from two high ridges capped by deposits, and diverging from a common point; in the intervening space will be seen many secondary ridges, sometimes 1,500 or 1,800 feet high, formed entirely of the older rocks, no traces of deposits being found on their surface nor in the ravines that lead from them.

“The depth of these deposits is extremely variable. Sometimes nothing more than a trace of them, in the presence of a few round pebbles lying on the top of a ridge, is found, the valleys and ravines in the neighbourhood containing their disintegrated elements in considerable quantities. In other circumstances, particularly where spread out over

the elevated flats, they are of a moderate and pretty uniform thickness for a considerable distance, varying from 2 to 3 feet to a few inches, and this, too, in positions where the surface could not have been exposed to any great amount of denudation. They are again found many hundred feet in thickness, composed of superimposed strata of different mineralogical constitution, generally horizontal and conformable with each other.

“The localities where the deposits are met with most extensively disclosed, and that have been worked, are at Nevada and at Mokelumne Hill. At the former place they form the crest of a high mountain called the Sugar-loaf, full 2,000 feet above the level of Deer Creek, the upper 600 feet being formed entirely of diluvial strata. At Mokelumne Hill they are also 200 feet deep, forming here also the summit of a high and isolated mountain. The elements of which they are composed differ considerably in different localities, although there are through the whole series many points of resemblance. In the lower valleys and flats between the ranges of the lower hills, they appear to consist of beds of gravel, containing occasional boulders of quartz and the harder rocks. On the elevated flats higher up in the mountains the surface of these deposits is generally covered with a reddish loam, mixed with small gravel; whilst reposing on the bed rock, and a few inches above it, is found a stratum containing large boulders and gravels, the boulders being principally quartz. On the tops of the hills and the crests of the ridges, where they generally attain their greatest thickness, we find them composed of many distinct strata lying nearly horizontal and conformable with each other, and generally also with the surface of the underlying rocks. In these situations the most superficial stratum is composed of a mass of extremely hard conglomerate, containing principally trachytic rocks, imbedded in a hard argillaceous cement. It is this hard stratum that has undoubtedly preserved the underlying beds from the destructive influence which has so powerfully acted on the surrounding rocks.

“At other points the whole series consists of conglomerates



and soft friable sandstone. In the lower strata, quartzose conglomerates with an argillaceous cement, or loose quartzose gravel always prevails, with large boulders of quartz, weighing frequently 2 or 3 tons, having their surface worn smooth and the angles rounded. The deposits of the heavier rocks have been formed on spots which were evidently lower than the level of the surrounding rocks; whilst on those parts which were higher at the time the deposits were formed, the higher trachytic rocks are found. As far as Blake's researches have extended, the more quartzose conglomerates have been invariably found on the erupted rocks, whilst the stratified rocks which they had upheaved were only covered by the trachytic conglomerates. The pebbles of which these conglomerates are composed present specimens of all the harder rocks; metamorphic sandstones, clinkstone, trap porphyries, and quartz, make up the larger part of the mass. They are all perfectly rounded, but in the lower deposits are so soft that, with the exception of the trap and quartz, they generally fall to pieces on exposure to air. The strata, as before observed, are nearly horizontal and conformable; if they have any dip, it appears to have been owing to the slope of the surface of the rock on which they were deposited; in fact, no displacement seems to have taken place in this country since the time of their formation. They lie perfectly horizontal over the almost vertical edges of the upheaved slate rocks.

“As regards the mineral riches of these deposits, it would appear that gold is found wherever they exist. The ravines coming from the ridges on which they are found are generally extremely rich, and always contain gold, even in places where the deposits themselves have been worked without success. In some places where they have been worked, as much as 30,000 dollars have been taken from a claim of 15 feet square, and there are many instances where 10,000 and 15,000 dollars have been taken from claims of the same size. But few of these rich spots have, up to the present time, been opened, yet there can be no doubt but that many still remain to be discovered. Where the deposits are found extending over a large surface on the elevated flats, gold is

always met with, generally diffused through the gravel immediately above the rock on which they rest."

2. **Australian Gold Mines.**—For the purpose of conveying a correct idea of the conditions under which the greatest quantity of the Australian gold occurs, the three following plans have been taken from Ure's Dictionary of Arts, ii., pp. 503, 504. Fig. 180 represents a longitudinal section along

FIG. 180.

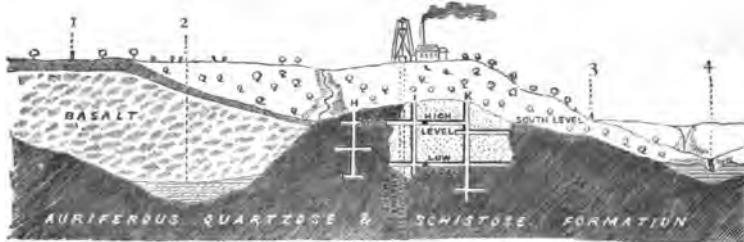

1. Auriferous drift. 2. Boundary of workings. 3. Boundary fence.  
4. Creswick's Creek.

the course of the west quartz vein in the Clunes gold mining field. We have here, as indicated by the darker portions of the wood cut, the quartz vein shown in section, with the shaft sunk, and the levels driven upon it. The lighter portion of the figure resting on the quartzose rock is an auriferous drift; and on the left of the section the great basaltic formation is shown.

Fig. 181 is a section of a portion of the Ballarat gold field. It is an east and west section from the Red Streak lead, across Post Office Hill, White Flat, the township of Ballarat West, and the quartz reef west of the township; and it shows the auriferous drift, schist, quartz, and basaltic formation of the district.

In those two sections, therefore, we have shown all the conditions of the processes of mining on the quartz lodes and in the alluvial deposits.

Fig. 182 is a section from the Boroondara and Bulleen gold mines, a few miles from the capital of Victoria. It is the east and west section of the Carlton Estate quartz reef.

Gold ores also occur in British Columbia, Mexico, Peru, in different parts of Asia, Africa, and of Europe.

FIG. 181.



1. The town of Ballarat East. 2. The main road. 3. The Red Streak lead. 4. The Creek. 5. Old Post Office Hill, with quartz reef. 6. Basalt escarpment south of Golden Point. 7. White flat recent auriferous alluvial deposit. 8. Yarrowee Creek. 9 and 11, are two shafts sunk into the ancient auriferous alluvial deposits. 10. The Gravel Pits lead. 12. Quartz reef beyond the town of Ballarat West, shown in the drawing. B, is the remains of a lava stream, interrupted by the schist and clay slate hills. D, D, is the gravel strata which invariably rests on the side of the schist hills which surround the Ballarat basin.

FIG. 182.

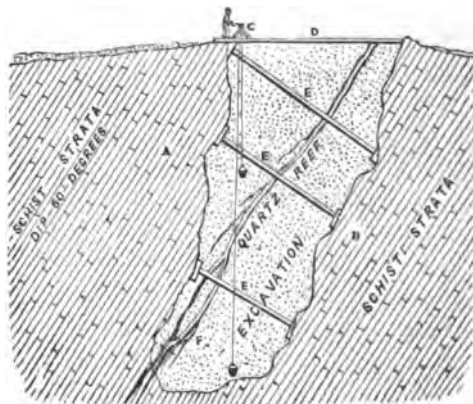

#### SYNOPSIS OF PROCESSES FOR THE EXTRACTION OF GOLD FROM ITS ORES.

All the different methods for the extraction of gold yield, in the first place, either argentiferous gold or auriferous copper, and vary according to the quality of the ore (whether the ores contain the gold in the native or in a combined state, whether they are associated with earthy or sulphuretted substances, what amount of gold they contain, &c.);

the price of materials, and local circumstances also decide the applicability of certain methods to certain cases.

Some of the processes are purely mechanical, others chemical, and some are a combination of both kinds, as will be seen by the following review:—

1. **Extraction of Gold by Washing the Ores.**—This is the simplest and cheapest of the processes, and may be applied to gold sand, or earthy minerals containing gold more or less compact and in conspicuous grains; finely granulated earthy minerals which are neither aluminous nor calcareous are best adapted to this process. Ores containing gold in a finely divided state or in thin spangles are less adapted to this method of extraction, as the gold is easily carried away by the washing water. Metallic sulphides containing combined gold cannot be treated by this process.

The yield of gold by the washing process is only imperfect because part of the gold, being in a finely divided state, is carried away by the water, and another part remains in denser particles of sand and clay. The washed gold always contains grains of admixtures of great specific gravity, such as magnetic iron ore, &c., from which it must be freed by a purifying smelting with fluxes (carbonate of potash, borax, saltpetre). The main condition of a perfect dressing of gold ores is the production of grains of uniform size,\* of the gold as well as of the admixtures, and as this condition can only be fulfilled in rare cases, although employing the most perfect dressing machines, the washing process is always more or less imperfect, causing a loss of 30 or 50 per cent of gold and more; and the richer the ore the greater the loss will be. The loss decreases if the grain of the crushed ore is uniform, and if a long plane is employed for washing the ore.

Seymour† has tried to separate the gold by the application of a blast of air.

2. **Amalgamation.**—This process is usually more profitable than washing, giving a better yield; the loss of mercury

\* B. u. h. Ztg., 1859, p. 267.

† Ibid., 1855, p. 381.

is small if the ores, &c., contain native gold but no gold in combination, if they are free from lead and bismuth, and if, being sufficiently finely divided, they are kept for a long time in contact with a large amount of mercury. As in the amalgamation in barrels,\* a great deal of the mercury employed becomes floured, gold mills† are more frequently used than barrels for amalgamating gold. These mills facilitate the contact of the mercury with the gold, but the contact is usually not kept up long enough; neither are the gold particles sufficiently separated from the gangue if the grinding and amalgamation of the gold ores are combined and effected in one apparatus. It is therefore advisable to crush the ores separately, and to wash them previous to submitting them to the amalgamation process.

Mitchell,‡ Becquerel|| and others have proposed more perfect apparatus. Urbas§ recommends the employment of hydraulic pressure in the amalgamation process, and Wickoff¶ advises that the finely divided ore should be boiled under water with half its weight of mercury.

Previous to amalgamation, sulphuretted ores containing combined gold are either roasted or allowed to decay by the influence of the atmosphere; sometimes they are amalgamated direct with an addition of chemical reagents.\*\*

Ores containing both native and combined gold, are first treated by the amalgamation process for the extraction of the native gold, and afterwards submitted to another process, which will be described, to extract the combined gold. Similar ores in Salzburg, Hungary, and Transylvania are first washed and then amalgamated, and in the Tyrol they are first amalgamated after being finely divided, and then washed.

At the same time, silver if present in the native state or otherwise can only be extracted by chemical agents. Sometimes an addition of mercury is made when crushing

\* B. u. h. Ztg., 1859, p. 266, 268. Berggeist, 1861, No. 36.

† Oesterr. Ztschr., 1861, No. 41.

‡ B. u. h. Ztg., 1859, p. 283; 1862, p. 391.

|| Bgwkd., v., 52.

§ Oesterr. Ztschr., 1854, p. 79.

¶ Polyt. Centr., 1858, No. 16.

\*\* B. u. h. Ztg., 1862, pp. 83, 138. Berggeist, 1861, No. 36.

auriferous and argentiferous ores, thus extracting the gold; the argentiferous residues are then submitted to the American amalgamation process. Mr. Crookes's sodium amalgamation process is now most advantageously applied to the treatment of gold ores.

3. **Smelting Processes.**—Argentiferous and auriferous sulphuretted ores and products are freed from the gold and silver they contain by fusion with lead compounds. The resulting auriferous and argentiferous lead is cupelled to produce brightened silver, from which the gold is extracted in the wet way; sometimes part of the native gold is previously extracted from the ores by amalgamation. Earthy ferruginous gold ores are only in rare cases smelted for the production of auriferous iron, and the gold extracted from this iron in the wet way.

Balback \* advises a fusion of the auriferous and argentiferous lead in a reverberatory furnace together with zinc, when an alloy of gold, silver, and zinc will be formed, from which the lead may be liquated.

Lead is an excellent agent for extracting gold in the native as well as in the combined state, but fusion takes place quickly, preventing a perfect extraction, and leaving the slag more or less rich in gold; so that the process must be several times repeated with the intermediate products, causing a great loss of metal (chiefly lead), and great expense for fuel and labour.

Ores containing combined gold† to the amount of 0.0024 per cent cannot be profitably fused with lead even could they be raised without mining cost, and they require a previous preparation to concentrate the gold, if the nature of the ores admits of it. Ores still poorer, and containing from 0.001 to 0.002 per cent of gold must be submitted to a previous concentration smelting with iron pyrites, but this smelting causes a great loss of gold in the slags, a loss which is increased the more difficult they are to fuse, as gold partly enters the matt mechanically, and not alone, like silver,

\* B. u. h. Ztg., 1864, p. 394.

† KARST., Metallurgie, iv., 654.

in chemical combination. Part of the gold present in the matt appears to be chemically combined with sulphide and anti-monide of silver, and is only liberated by the roasting process;\* if only containing 0·0005 per cent of gold, these slags still are richer than some minerals which are profitably treated either by the washing process, or by amalgamation for the extraction of their contained gold. The Abyssinian gold sand, for instance, contains only 0·000434 per cent of gold, yet is profitably treated by the washing process, although entailing a great loss of gold. The presence of silver in the ores has no essential influence on the concentration of gold in matt.

Poor gold ores containing other valuable metals, such as silver and copper, in such quantity as to be profitably extracted, are submitted to a suitable smelting process, without taking special care for the small amount of gold which frequently collects in the produced silver or black copper in such quantity as to make its extraction profitable. For instance, gold is produced from the ores on the Altai containing  $\frac{3}{4}$  oz. of silver per cwt., and 0·000781 per cent of gold, from ores at Kremnitz containing 0·0005 per cent of gold when raw, and 0·0015 per cent in a dressed state. The ores at Nagyaga contain from 0·00088 to 0·0048 per cent, and the ores from the lower Hartz only contain 1-6,573,200 per cent of gold.

When lead ores poor in gold are smelted in reverberatory furnaces† most gold collects in the lead which is first tapped off, and the gold may sometimes be extracted from it with profit.

**4. Extraction of Gold by Solution and Precipitation.** These methods are applied when none of the preceding processes are applicable, owing to the very small amount of gold present, or to its combined state, or if the extraction of silver and gold together is attempted.

Of all reagents for extracting gold and silver at the same time, lead is the most effective, but until lately no reagent was known for dissolving both metals, and complicated

\* Oesterr. Ztschr., 1857, p. 331.

† B. u. h. Ztg., 1860, p. 360.



processes were required to separate the metals and extract them one after the other. Patera\* discovered such a reagent, namely, concentrated solution of common salt saturated with chlorine gas, which dissolves both these metals, whether alloyed or in ores. A similar method is proposed by Rösner†, but he first extracts most of the chloride of silver with hot solution of salt, and afterwards the remaining silver and gold by an alternate treatment of cold solution of common salt containing chlorine, and of hot solution of common salt.

The chief modes at present adopted for extracting gold may be classified under the three following divisions:—

### I. Production of Argentiferous Gold.

This division may be subdivided again into—

1. **Extraction of Gold from Gold Sand**, which is done in America, South Australia, China, Russia, on the Rhine, &c., by a mere washing either by hand or in machines. The gold sand is washed and amalgamated, in Hungary, Transylvania, Banat, Russia, Portugal, Brazils, Thibet, &c.; and in Siberia it is smelted in cupola furnaces for the production of auriferous pig-iron from which the gold is extracted by means of acids.

2. **Extraction of Gold from Earthy Ores.**—Auriferous quartz in Mexico, California, Brazils, Transylvania, &c., is crushed by stamping or rolling mills, and washed and amalgamated. In Transylvania auriferous Dürr ores are smelted with iron pyrites, producing an auriferous matt, from which the gold is extracted by a fusion with lead.

3. **Extraction of Gold from Sulphuretted Ores.**—In Marmato, iron pyrites is allowed to decay by atmospheric influence and then washed; in the Tyrol, Salzburg and Schemnitz, the ores are washed and amalgamated; in Hungary, the Lower Hartz, Transylvania, and Lend, auriferous copper, silver, and lead ores are fused with lead. At Reichenstein and Schemnitz, the ores are dissolved and precipitated by Plattner's method; at Arany Idka, the ores are treated by the methods of Kiss, Patera, and Rösner;

\* Oesterr. Ztschr., 1863, pp. 165, 243.

† Ibid., 1863, pp. 193, 211, 220, 316.



and at Freiberg, Chessy, and Colorado, the method of lixiviating with sulphuric acid is followed.

[www.libtool.com.cn](http://www.libtool.com.cn)

## II. Separation of Gold from Silver.

This separation is effected in the dry way either by a fusion with grey antimony ore, or by cementation with a chlorine compound; it is effected in the wet way by means of nitric acid, sulphuric acid, or aqua regia.

## III. Separation of Gold from Copper.

The auriferous copper is either fused with lead and liquated, or cupelled with lead. At Septèmes it is treated with boiling concentrated sulphuric acid, and at Oker with hot dilute sulphuric acid. At Swansea, Plattner's method is used.

## I. PRODUCTION OF ARGENTIFEROUS GOLD.

### 1. Extraction of Gold from Gold Sand.

The largest amount of gold is produced from gold sand or from auriferous rocks or minerals which have been decayed, and which extended over large districts. The amount of gold this sand should contain to make its working profitable varies in different localities, and has no fixed limit, but is decided by experience.

The gold sand on the Ural, from which a considerable quantity of gold is produced, contains, on an average, only 0·000005 per cent of gold, and may be worked when containing only 0·000001 per cent. The sand worked on the Rhine\* contains, on an average, 0·00000032 per cent of gold, and the richest sand contains five times less than the sand in Siberia and ten times less than that in Chili. The sand of the Rhine is considered profitable if containing 0·00000012 per cent of gold, whilst sand in Siberia containing 0·000001 per cent is considered unprofitable.

Five tons of Siberian sand yielded from 0·38 to 1·50 ozs. of gold, and 5 tons of Californian sand, 2½ ozs. of gold.

\* V. DÜCHEN, Statistik. d. zollv. Deutchl., i., 758. Bgwkfd., xi., 43, 307, 713.

According to Von Cotta, 50 tons of gold ores in Salzburg and the Tyrol (auriferous quartz and pyrites) contain gold worth about £47; 50 tons of ore at Monte Rosa contained gold worth from £80 to £3,400; on the Ural (gold sand) £3,000; and gold sand in California from £30,000 to £39,000.

The amount of chemically pure gold in washed gold varies in different localities. The Siberian gold contains from 84 to 94 per cent; Bornean from 82·9 to 93·7 per cent; and Californian, from 89·2 to 89·7 per cent. Gold from the Rhine contains 93·4 per cent of gold, 6·531 per cent of silver and 0·069 per cent of platinum; gold from Altai, 86·73 per cent of gold and 12·69 per cent silver; from Nertschinsk 93·25 per cent of gold and 3·37 per cent of silver. Gold from the Gongo-Soco mine in Brazil contains 84 per cent of gold, 4·5 per cent of silver, 3·1 per cent of palladium, 2·6 per cent of platinum, and a trace of iridium. Gold from Tangier in Nova Scotia contains 98·13 per cent of gold, 1·76 per cent of silver, 0·05 per cent of copper, and a trace of iron.

**Extraction of Gold by Washing Gold Sand.**—The washing of gold sand is either effected by hand in gourds\* or in wooden dishes and troughs, or the sand is made to pass over hides† by means of a stream of water; the gold is then entangled in the hairs of the hides, and is concentrated by a further washing (Brazils); strakes‡ provided with cross gutters (Sardinia) or coated with cloth are sometimes used for washing the sand. The cradle,|| Long Tom,§ and in fact all known apparatus are used in California and Australia. The hydraulic method of mining is also used in California;¶ a strong jet of water is conducted against the alluvial banks to loosen them, and the washed off mass is made to pass through settling cisterns. Sometimes gold washing is profitable only as an addendum to other metallurgical works.\*\*

\* Russegger's Reisen, iii., 313, 727, 747.

† B. u. h. Ztg., 1859, p. 258.

‡ Ibid., 1863, p. 342.

|| Ibid., 1862, p. 278.

§ Ibid., 1862, p. 278.

¶ Ibid., 1860, p. 120.

\*\* Oesterr. Ztschr., 1856, p. 25; 1859, No. 10.

The loss of gold is very large in the rougher methods of washing. Gold sand\* is washed in America, (Brazil, California, &c.), Australia, China, Siberia, on the Rhine, Silesia, Bavaria, Schwarzburg-Rudolstadt, Bohemia, Salzburg, Carinthia, Hungary, Transylvania, Ural, Baden, Sardinia, Bolivia, &c.

Experiments made at Siberia have shown that the gold sand contains 131 times more gold than is obtained from it by the common method of washing.

**Extraction of Gold by Washing and Amalgamating Gold Sand.**—This method is much more perfect than the mere washing operation, and the point is to ascertain experimentally how much the sand should be washed in order to produce a schlich sufficiently concentrated for treatment with mercury. The amalgamation is usually effected in stone or iron vessels, by grinding 1 part of sand and 2 parts of mercury by means of a wooden pestle till practice shows that the gold has combined with the mercury. The separated amalgam is pressed through bags of canvas or leather, and the compact amalgam heated either in the open fire or in some closed apparatus (bell apparatus or retorts). A distilling furnace is constructed simply by putting a perforated clay or iron plate upon a round vessel filled with water, and placing the amalgam upon the plate; a crucible is then inverted over the amalgam, and luted to the vessel standing beneath. On heating the crucible by a surrounding fire of coal, the mercury distils and condenses in the water of the lower vessel. The remaining gold is then thoroughly heated on an iron plate and melted in a plumbago crucible, either by itself or with an addition of borax. Neutral borate of soda† is said to be a better flux than borax.

The residue from the amalgamation is usually auriferous

\* B. u. h. Ztg., 1842, pp. 148, 289, 837; 1844, p. 567; 1845, pp. 713, 755; 1846, p. 614; 1847, pp. 705, 749; 1850, pp. 52, 88, 159, 495; 1852, p. 529; 1853, pp. 173, 273; 1854, No. 26; 1863, p. 342. Bgwkd. i., 373; ii., 494; xi., 43, 307, 713; xii., 395, 767, 783, 800; xiii., 26, 197, 256, 288, 351, 371, 398, 575, 591, 822; xiv., i, 31, 46; xv., 31, 382, 409, 481, 799; xvi., 17, 48. Ann. d. Min., 1 sér., ii., 199; 2 sér., i., 178; iii., 283; 1 livr., de 1843, p. 19; 4 sér., xvi., 127; 1858, livr. 1, p. 155. KARST., Arch., xvii., 321. Pogg., lxxviii., 96. DINGL., Bd. 12, p. 116; Bd. 114, p. 287. ERDM., J. f. pr. Ch., xlvi., 405.

† Zeitschr. f. d. Oestr. B. u. Hüttenw., 1854, p. 50.

and sometimes worth dressing and amalgamating again. Peculiar apparatus for amalgamation have been constructed by Kleimenow\* and Okladnie.†

This mode of amalgamation‡ is or has been practised in Hungary, Transylvania, Russia, Portugal, Brazils, Thibet, Guinea, &c.; amalgamation in barrels is also used in Siberia.¶ The schlich, concentrated by washing, and still containing magnetic, titanitic, and chrome iron ore, is roasted with common salt, ground and treated in rotating casks with from 0·05 to 0·2 of its weight of mercury, 0·05 of iron filings, and the same quantity of sulphuric acid and water.

**Extraction of Gold by Smelting the Gold Sand.**—Anossow§ tried to smelt Siberian gold sand with fluxes, in iron blast furnaces, for the production of auriferous pig iron, and then to extract the gold by sulphuric acid. These trials show that the smelting produced twenty-eight times as much gold as the common washing; smelting in a copper ore furnace yielded even eighty-seven times more gold.

Ulrich¶ recommends that in certain cases auriferous and ferruginous quartz should be smelted for the production of auriferous pig iron.

## 2. Extraction of Gold from Earthy Minerals.

These ores may be worked by the following methods:—

*a. By Crushing and Washing the Ores.*—Auriferous quartz, &c., when not too poor, are crushed by stamping mills, and washed over strakes; according to Hocheder the loss of metal is from 40 to 50 per cent.

*b. By Crushing, Washing, and Amalgamating the Ores.*—The ore (auriferous quartz) is either crushed and amalgamated in one apparatus (Mexican Arrastra, Berdan's

\* Bgwkd., xvii., 565. B. u. h. Ztg., 1855, p. 62.

† Bgwkd., xxi., No. 4.

‡ Ibid., 1854, p. 50.

¶ Berggeist, 1861, No. 36.

§ Bgwkd., i., 478. KARST., Arch., 2 R., xi., 406. LAMP., Fortschr., 1839, p. 220.

¶ Bgwkd., iii., 286.

machine,\* &c.), or a different apparatus† is employed for each operation; if necessary, the ores are washed previous to amalgamation, which is usually performed in mills, seldom in rotating casks. Sometimes the quartz is burned previous to its crushing, but this is said to cause a volatilisation of gold. Though this method of extraction is more perfect the residues are rich in gold, as the crushing of the quartz beats the gold into the form of scales or spangles, which are easily carried away by the water, and as the efficacy of the amalgamation process is impaired by its rapidity, and by the difference in proportions of gold and quartz; this difference causes the residues of poor ores to be richer in gold than the residues of rich ores; Mitchell's apparatus is said to be free from many of these disadvantages.

### Illustrations of the Extraction of Gold from Auriferous Quartz.

In Mexico‡ the gold ores are ground in arrastras such as are used in the amalgamation of silver ores (p. 336); water and mercury are added to the grinding mass. The formed amalgam is from time to time tapped off and distilled in retorts; this mode of dividing or grinding the ores is both slow and expensive. A similar method with edge stone mills is used in Chili,|| but the yield is only 33 per cent of the gold contained in the ores, and the loss of mercury is considerable. In Sardinia§ mills with horizontal stones are used.

In California¶ and Australia\*\* auriferous quartz is usually pounded under stamps, washed and amalgamated in mills, or amalgamated previous to washing. The smallest amount of grease hinders the combination of the gold with mercury. Large masses of ore containing 5 pennyweights per ton of washed out gold are profitable when judiciously treated, as the working of 1 ton of ore costs less than 12s.

\* B. u. h. Ztg., 1851, p. 416; 1854, p. 30. Dingl. Bd. 133, pp. 420, 421, 424.

† Ibid., 1859, p. 183; 1861, p. 208. Oesterr. Ztschr., 1860, No. 50.

‡ B. u. h. Ztg., 1859, p. 266; 1840, p. 291.

|| Ibid., 1862, p. 279.

§ Ibid., 1863, p. 342.

¶ Preuss. Ztschr., iv., 144.

\*\* B. u. h. Ztg., 1859, p. 183; 1862, p. 291.

In Brazil\* finely pounded auriferous quartz is passed with water through a copper sieve, and then over cow-hides, which are washed every two hours, and the concentrated mass, in quantities of  $\frac{1}{2}$  ton, together with water and mercury, is made to rotate in casks for from 12 to 30 hours, the casks making 18 revolutions per minute. Then more water is added and the casks are turned at a slower rate to unite the floured mercury, and the amalgamation is finished as if treating silver; by this tedious process the yield of gold is from 60 to 70 per cent.

In Transylvania† the gold ores containing little or no silver are finely powdered in stamping mills, and washed on strakes; the resulting gold schlich is washed in a hand-trough and amalgamated in mortars. Gold and silver ores from which part of the gold can be extracted by dressing or amalgamation, are pounded, and the finely powdered ore is conducted over strakes covered with canvas, or passed through amalgamation mills to extract part of the native gold previous to a further dressing and smelting of the ores. This preparatory treatment is very inexpensive, and frequently concentrates the gold sufficiently to pay the cost of dressing and smelting.

In various parts of the Tyrol strakes have been replaced by amalgamation mills. Ores containing from  $2\frac{1}{2}$  to 4 ozs. of gold yield  $\frac{1}{2}$  oz. more gold when treated by the mills. But as 50 tons of ore consume  $1\frac{1}{2}$  lbs. of mercury, which consumption depends more on the quantity than on the quality of the ores, mills are only profitable when the ores contain a certain percentage of gold, which must not be too small; if the amount is too high, the gold is not sufficiently exposed to the action of the mercury, and the strakes give a better yield, especially if their length is suitable. When treating rich ores in mills the muddy water is conducted over a strake, after having passed three mills.

**c. By Smelting Poor Earthy Gold and Silver Ores with Iron Pyrites, and treating the Resulting Matt**

\* B. u. h. Ztg., 1859, p. 266.

† Bgwkd., x., 214. Oesterr. Ztschr., 1858, pp. 33, 54.

with Lead.—At Offenbanya\* in Transylvania poor argentiferous and auriferous ores have part of their gold extracted either by dressing or by gold mills, and are smelted with iron pyrites for the production of raw matt; the matt is then roasted and re-melted with ores moderately abundant in metal; the enriched and roasted matt is smelted with rich ores, and the matt resulting from this smelting is tapped off into an outer crucible, and fused whilst liquid with lead poor in silver. The remaining lead is strongly roasted and smelted with rich ores containing copper pyrites until it is converted into copper matt, when it is added to the copper smelting process.

At Szalathna† rich Dürr ores, containing noble metals, pyrites, and earths, are treated as the rich ores in Offenbanya; but plumbiferous and auriferous ores are smelted in admixture with lead products for the production of auriferous raw lead and matt. At Offenbanya this matt is then treated with metallic lead for extracting its gold and silver. The richest gold ores only are smelted with so large an addition of lead fluxes as to combine all the noble metals with lead, and to produce a poor matt.

Longmaid‡ has suggested a method for the extraction of gold which occurs disseminated in rocks. The pounded ores are passed through a sieve having at least three holes per square inch; the fine ore which has passed through the sieve is then mixed with roasted iron pyrites, peroxide of iron, limestone, and fluor spar, and, after grinding, the mixture is smelted in a reverberatory furnace, when the greater part of the gold will precipitate, and part of it enter the slag. On dipping an iron plate into the slag, gold deposits upon its surface, and on dipping the red-hot plate into fused lead the gold is dissolved off by the lead.

### 3. Extraction of Gold from Sulphuretted Ores.

The sulphuretted ores sometimes containing gold are chiefly iron pyrites, arsenical pyrites, and various copper, antimonial, zinc, and lead ores. The processes employed

\* Bgwkfd., iii. 286; iv., 62; x., 209.

† Ibid., x., 231.

‡ B. u. h. Ztg., 1853, p. 268.

EXTRACTION OF GOLD FROM SULPHURETTED ORES. 619

for extracting gold from sulphuretted ores differ according to the amount of gold contained in them, and the state in which the gold occurs, whether in a native or a combined form, or whether in both states at the same time. The processes are also influenced by local circumstances; lead is an excellent agent for extracting gold in both states, and it extracts the silver at the same time, but it has the disadvantages mentioned on page 619. Mercury extracts the native gold only; the combined gold requires a previous reduction either by roasting the iron pyrites, or by allowing it to decay. Storer and Whelpley\* recommend roasting finely divided pyrites by Gerstenhöfer's method† in a furnace in which the ore is suspended in an atmosphere of hot air and steam, when it oxidises and falls into water, which dissolves the formed sulphates; the residue is amalgamated.

Other processes in the wet way require the gold to be present either in the metallic state or as a chloride, and must therefore be subjected either to an oxidation roasting (Plattner's method), or a chlorination roasting (methods of Kiss, Rösner, and Patera); in the latter case gold and silver may be extracted at the same time.

When roasting auriferous metallic sulphides and arsenides the metallic gold remains in the roasted mass in a very finely divided state. Plattner‡ found, when roasting such substances at different temperatures, and for shorter and longer times, that a loss of gold takes place when the roasting is conducted very briskly; sublimation of gold and volatilisation of oxidised gold do not take place; but the volatile roasting products carry off fine particles of gold. Aidarow|| confirms the non-volatilisation of gold in the roasting of raw matt; Winkler§ found the loss of gold to be from 3·4 to 4 per cent, when roasting auriferous mixtures on a small scale. V. Tscheffkin states that he has ascertained the loss of gold to be from 32 to 100 per cent, and that of silver from 2¼ to 28 per cent when roasting auriferous and

\* B. u. h. Ztg, 1864, p. 392.

† Ibid., 1864, p. 6.

‡ PLATTNER'S Röstprocesse, p. 127.

|| Bgwkfd., xviii., 1.

§ LAMP., Fortschr., 1839, p. 58.



argentiferous raw matt in mounds and in reverberatory furnaces; but these investigations seem to be erroneous.

Elsner\* placed a sample of gold upon a piece of glazed porcelain, and exposed it to the fire of a porcelain furnace; he found upon the porcelain a distinctly yellow coloured deposit, which the microscope showed to consist of globules of fused gold.

W. Napiert considers gold to be volatile at a very high temperature; it also volatilises when re-melted in crucibles, especially when combined with copper. If the fused gold has been covered with a layer of bone ash, the ash will be coated with volatilised gold of a purple colour. The microscope does not reveal globules of gold in this coating, but grains of gold may be obtained by smelting; so that the question of whether gold is volatile in a finely divided state or in combination is still unanswered.

According to Deville,† gold volatilises when melting auriferous platinum, and may be collected by condensing the gold vapour.

**a. Extraction of Gold by Washing Decayed Pyrites.—**According to Boussingault and Becquerel,‡ from  $\frac{1}{3}$  to  $\frac{1}{4}$ ths of the gold are lost when washing raw pyrites, and the loss increases if the ores are not washed in a very finely divided state. At Marmato§ in Brazils, pyrites containing 0.02 per cent of gold, is treated in the following manner:—

The ores are ground and washed; the concentrated mass is allowed to decay and then washed again, and gold is extracted by a repeated washing and decaying.

**b. Extraction of Gold from Sulphuretted Ores by Washing and Amalgamating.—**The ores are usually washed in the raw state, and amalgamated¶ for the extraction of the native gold (mill gold), the remaining gold and silver are then extracted by fusion with lead. In rare cases, the ores are washed, roasted, and amalgamated.

\* Polyt. Centr., 1859, No. 5, p. 317.

† Ibid., 1858, No. 14, p. 967.

‡ DINGL., cliv., 138.

§ Bgwkd., v., 50.

¶ Ann. d. min., 2 sér. i., 319. ERDM., J. f. pr. Ch., i., 490. KARST. Arch., 2 R., xvii., 176.

¶ B. u. h. Ztg., 1857, pp. 205, 210. Polyt. Centr., 1857, p. 1461.

Extensive experiments have been made at Schemnitz,\* with the view of ascertaining whether it is more profitable to extract all the gold by a mechanical dressing and fusion with lead, and do away with the extraction in the mill; the results were in favour of the mill amalgamation, chiefly with regard to the yield of metal.

The amalgamation† is either effected at once, with the muddy water resulting from the stamping mills, and a further dressing afterwards performed (Tyrol, Schemnitz), or the pounded ore is fully dressed and the resulting schlich is amalgamated (Salzburg). Friable ores poor in schlich are better adapted to the former process, whilst ores rich in schlich are best treated by the Salzburg method; the loss of gold is sometimes lessened by combining both methods.

The construction of amalgamating mills‡ varies somewhat in different localities; in the Tyrol the mills make 18 or 20 revolutions per minute and are charged with 50 lbs. of mercury; the muddy water has rather a thick consistence, and the amalgam formed is removed from the mills every month. In treating schlich the Salzburg mills make from 80 to 90 revolutions per minute and are charged with 3 or 4 lbs. of mercury, on account of the greater velocity of the mills which would otherwise cause loss of mercury; mercury is gradually added till a mill contains 10 or 12 lbs.

The muddy water is passed either through one or two mills, seldom through more than two; usually the mercury remains in the mills till it is saturated with gold. For the perfect extraction of the mill gold, Sennhofer|| employs mercury obtained by distilling the liquid amalgam from the mills; this method is more valuable when extracting mill gold than when treating schlich. Urbasz§ conducts the muddy water beneath the mercury; other methods proposed by Lill and Sennhofer gave unsatisfactory results.

\* Oesterr. Ztschr., 1854, p. 2. RITTINGER's *Erfahr.*, 1854, p. 39; 1858, p. 29.

† Leoben. Jahrb., 1857, vi., 224.

‡ Ibid., 1857, vi., 217, 224. Oesterr. Ztschr., 1861, No. 41; 1856, No. 28.

|| Oesterr. Ztschr., 1854, p. 34; 1856, p. 285. *Berggeist*, 1859, No. 4.

§ Oesterr. Ztschr., 1856, p. 287.

### Illustrations of the Process of Washing and Amalgamating Sulphuretted Ores.

At Schemnitz,\* lead ores containing from 5 to 10 ozs. of mill gold per 50 tons, and 3 or 4 lbs. of silver ores in 50 tons, are pounded, and the muddy water of the pounding mill is made to pass through two mills which are connected with each other. The mills are represented by Figs. 183 and

FIG. 183.

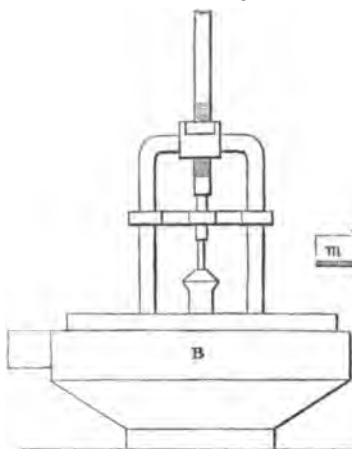
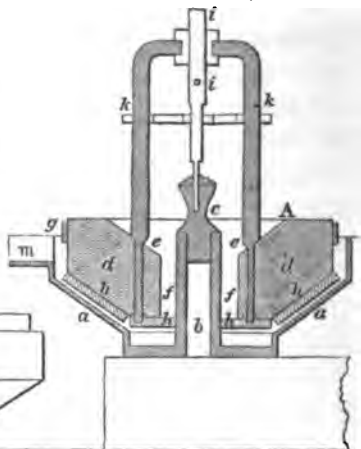

FIG. 184.



184. *a, a*, are cast iron vessels, 6·5 inches high, and 2 feet and 1·5 feet wide on the top and bottom, respectively; in the middle they are furnished with a projecting tube, *b*, which is cast together with the vessel so as to form one piece. The pan, *c*, is fixed in the tube, *b*; *d* is a wooden runner with a hole, *f*, which is 5 inches wide, and excavated conically at *e*. The space between the runner and the vessel is  $\frac{3}{4}$  of an inch; the mercury forms at the bottom of the vessel a ring 7 inches broad, and  $\frac{1}{2}$  inch high, when 50 lbs. of mercury are added. *g* are rings of iron plate fixed round the runner. *h* are twenty teeth of thick iron plate,  $2\frac{1}{2}$  inches long, and  $\frac{3}{4}$  of an inch broad, placed radially. *m* is a spout for running off the muddy water; *i* is the piston fixed to the runner, *d*, by means of the bow, *k*, and connected with its upper end by some moving apparatus.

\* RITTING., *Erfahr.*, 1854, p. 29.

The muddy water is conducted by means of gutters from the stamping mill to the upper row of mills A, and thence into the lower row B. Three stamps produce 0.015 cubic foot of muddy water per second, containing  $\frac{1}{2}$  or  $\frac{3}{4}$  oz. of mud, which quantity is made to pass one mill in the same length of time. The runners are removed every four weeks, the mercury is purified from a crust of pounded sand, and the amalgam removed and poured into canvass bags. The muddy water running from the mill B is conducted over strakes to other dressing apparatus where the grains are arranged according to their different sizes. The washed out gold schlich is then amalgamated in cast iron mortars by intimately mixing with mercury by means of wooden pestles.

The auriferous mercury is placed in the double bag, *a*, as shown by Fig. 185. The bag is suspended in the ring, *b*,

FIG. 185.

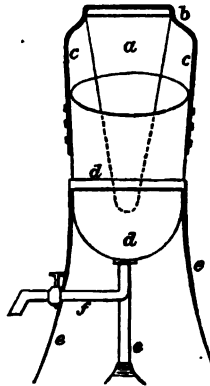

which rests on the three rods, *c, c, c*, above the iron pan, *d*, 15 inches high and 11 inches wide on the top. The mercury is then first pressed through the bag by hand, and the soft amalgam is further pressed through linen in contact with hot water, till hard amalgam is formed, containing from 30 to 35 per cent of mercury. The expressed mercury, containing about  $\frac{3}{4}$  of an ounce of gold per cwt. is tapped from the pan, *d*, by means of the tube, *f*. The amalgam

from the gold mills contains from 25 to 33 per cent of gold, that from the later amalgamation from 40 to 50 per cent.

The amalgam is formed into balls, each about 4 ozs. in weight, and enclosed in linen. It is placed upon the dishes, *a*, which are fixed to the pillar, *b*, as shown in Fig. 186.

FIG. 186.

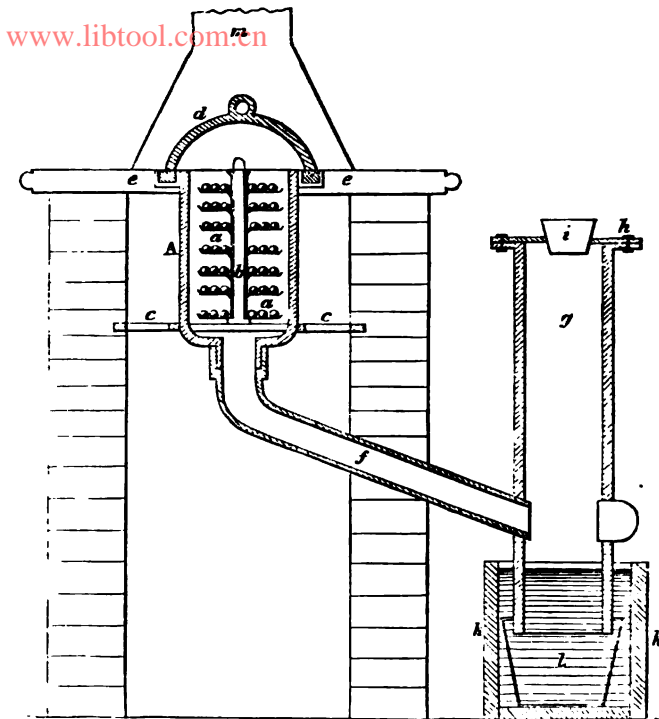

The surrounding tube, *A*, is heated from the grate, *c*; the lid, *d*, is luted; *e* is an iron plate; *f* is a tube for the escape of the vapours of mercury. The tube, *g*, is covered with the iron plate, *h*, and closed with the wooden plug, *i*; its lower part reaches into the box, *k*, which is kept filled with water; *m* is a movable chimney. The distillation commences after about one hour's firing; the mercury collects in the vessel, *l*, and the operation is finished in two and a half or three hours, when the lid, *d*, is removed, and the tubes, *f* and *g*, are cleaned from mercury, which is rubbed in a dish to form

globules; the lumps of gold which remain are cleaned with a brush and cupelled, at a loss of 0.44 oz. per lb. The yield of gold in the mills amounts to about 75 per cent, and of the later amalgamation to 25 or 30 per cent. The loss of mercury amounts to 1 lb. 3 ozs. or 1 lb. 8 ozs. per 50 tons when treating plumbiferous ores, and to 8 or 10 ozs. when treating ores free from lead.

At Zell\* in the Tyrol, auriferous and quartzose clay slate, more or less impregnated with pyrites, containing  $5\frac{1}{2}$  or 6 ozs. of gold per 50 tons, and a little schlich and auriferous silver are treated for the extraction of their gold. The ore is first pounded, and the muddy water conducted into a box with three compartments, whence it passes into three mills, each containing 14 lbs. of mercury, and making 20 revolutions per minute. When the mercury has become saturated with gold, the contents of the mills are removed, the collected schlich is washed with cold and hot water till perfectly pure, and the mercury is repeatedly pressed through soft leather. The produced amalgam is formed into small balls and heated in a bell apparatus (page 348); three mills treat 115 or 125 lbs. of schlich in 2.5 hours; the yield of gold is about 50 per cent.

c. **Extraction of Gold from Auriferous Copper, Silver, and Lead Ores by Fusion with Lead.**—Pyrites (iron and arsenical pyrites) free from other valuable metals, seldom contains sufficient gold to make its fusion with lead profitable. † the expense is chiefly covered by other metals present. These processes are then carried out with the object of extracting silver, copper, and lead, the gold collecting in the products (silver, copper, or copper matt) from which it is extracted. Plumbiferous copper ores containing gold and silver, which are unfit for treatment by the methods of Augustin or Ziervogel, are judiciously smelted for the production of copper matt, which is, after roasting, freed from its contained oxide of copper by dilute sulphuric acid. The remaining argenteriferous and auriferous mud is fused with lead (Freiberg,

\* B. u. h. Ztg., 1851, p. 593; 1852, p. 277. Oesterr. Ztschr., 1856, p. 283.

† Oesterr. Ztschr., 1854, p. 279. ERDM., J. f. pr. Ch., 1x., 169. B. u. h. Ztg., 1857, p. 44.

the Lower Hartz. Besides gold and silver, these methods extract nearly all the lead and copper, and the resulting gold is finer than the cupriferous amalgamation gold, &c.

*d.* **Extraction of Gold from Sulphuretted Ores and Smelting Products, &c., by Solution and Precipitation.**—Plattner's method† for auriferous pyrites (iron and arsenical pyrites). This method is based upon the fact that chlorine gas transforms metallic gold into soluble chloride of gold without much attacking the metallic oxides‡ present. Gold may be precipitated in a metallic state from a solution of chloride of gold in water by iron vitriol, sub-chloride of arsenic, metallic iron or copper, &c.; or in a sulphuretted state by sulphuretted hydrogen gas. The dried and roasted sulphide of gold is then cupelled with lead, or washed with muriatic acid, and melted with an addition of borax and saltpetre.

This method is also recommended for auriferous quartz|| or sand,§ and is adopted at Vivian's smelting works¶ near Swansea for the treatment of auriferous copper. The presence of silver interferes with the extraction of gold, as the formed layer of chloride of silver prevents a further solution.

The investigations\*\* of Plattner, Lange, Richter, Georgi, Duclos, &c., show that a favourable result depends on the following conditions:—

*a.* The gold in the substance under treatment must be present in a metallic state. If it is combined with sulphur or arsenic it requires a previous roasting at an increasing temperature, avoiding a strong draught, which would cause mechanical loss of gold. Any caking of the roasting mass (which is facilitated by the presence of lead, bismuth, &c.,)

\* B. u. h. Ztg., 1864, p. 384.

† PLATTNER'S Probirkunst m. d. Löthrohr., 1853, p. 571.

‡ Pogg. Ann., Bd. 112, p. 619.

|| DINGL., Bd. 149, p. 77. Polyt. Centr., 1858, p. 763.

§ B. u. h. Ztg., 1859, p. 339; 1860, p. 135.

¶ Ibid., 1863, p. 168.

\*\* Ibid., 1860, pp. 37, 133; 1861, p. 145; 1852, p. 169. Bgwkfd.,xiv., 202  
ERDM., J. f. p. Ch., li., 151. Preuss. Ztschr., 1855, iii., 128.

must be avoided as much as possible, and lumps should be carefully divided by a hammer. The roasting is continued until a slightly moistened sample has no reaction upon iron vitriol after long exposure in the air, otherwise iron vitriol, as well as arsenious acid and sub-chloride of antimony, will decompose chloride of gold.

*b.* No metallic sulphides and arsenides must be present, for which reason a perfect roasting is required, otherwise these substances will be transformed into metallic chlorides, causing an unnecessary consumption of chlorine. The chlorides become dissolved, and are partly precipitated together with the gold by sulphuretted hydrogen gas, &c. Also chloride of sulphur may be formed, which becomes transformed with water into muriatic and sulphuric acids; these acids dissolve metallic oxides. Iron must be converted into peroxide of iron by the roasting process, and no soluble foreign metallic salts must be present, otherwise the dissolved gold will be again precipitated by the iron; iron would also combine with chlorine, and the soluble metallic salts would contaminate the gold.

*c.* The chlorine gas employed must be free from muriatic acid, and therefore requires washing with water. Muriatic acid is liable to dissolve metallic oxides present, the metals of which would contaminate the gold during precipitation. Muriatic acid also forms sulphuretted hydrogen gas if, owing to an imperfect roasting, metallic sulphides are present. This gas sulphurises the dissolved gold. Chlorine water reacts less upon the warmed and damped ore than chlorine gas, and, according to Calvert,\* chlorine gas is most effective when in a nascent state, if produced in the ore mass itself from manganese and muriatic acid.

*d.* Lime in the ore increases uselessly the consumption of chlorine, and causes a variable yield of gold.†

*e.* The vessels must not be of wood or metal; earthen bottles are best, their bottoms contracted, and provided with

\* B. u. h. Ztg., 1865, p. 42.

† Ibid., 1860, p. 135.



an opening, which is covered with a pervious layer of crushed quartz.

f. The residues combine with a considerable quantity of water, and impede the perfect extraction of the dissolved gold. They must be washed as thoroughly as possible. Georgi\* proposes the application of a suction apparatus similar to that used in the manufacture of sugar.

g. The workmen must be protected from the ill effects of the chlorine gas by a judicious arrangement of the apparatus, by ventilation, &c. According to Rösner,† chlorine gas, which is always troublesome, and must be always applied in excess, may be advantageously replaced by a mixture of a cold solution of chloride of sodium and chlorine water. This reagent dissolves gold readily, and the gold is protected against all reducing agents occurring in the extraction vessel, and may be precipitated by copper.

Allain‡ states that gold may be extracted by chlorine from pyrites containing only 0·01 per cent, if it is previously roasted and freed from the greater part of the iron, copper, zinc, &c., it contains, by a treatment with sulphuric acid.

#### Illustrations of Plattner's Process.

At Reichenstein, in Upper Silesia, auriferous arsenical pyrites occurs, from which gold was extracted till the commencement of the seventeenth century, when the mining of galena was abandoned in that neighbourhood. Arsenical products were now extracted from the pyrites, leaving auriferous residues, which were unprofitable whether worked by fusion with lead or by amalgamation; they therefore accumulated up to the year 1851, since which time they have been sold at about 7d. per cwt., and treated by the chlorine extraction process in Güttler's gold establishment.

According to Von Dechen, the pyrites contains from 0·138 to 0·142 per cent of gold, and the residues yield from 0·041 to 0·05 oz. per cwt. 0·045 oz. per cwt. is usually extracted by chlorine, whilst the smelting and cupelling processes

\* B. u. h. Ztg., 1861, p. 145.

† Ibid., 1863, p. 336. Oesterr. Ztschr., 1863, Nos. 26, 27.

‡ DINGL., Bd. 63, p. 292. Polyt. Centr., 1849, p. 1343.

formerly applied yielded only 0.028 oz. According to Georgi, a yield of 0.014 oz. per cwt. should cover all working expenses, including those for materials, and the interest of the outlay capital.

The apparatus used for extracting gold are shown by Figs. 187, 188, and 189. The dressed schlich is kept in a store-

FIG. 187.

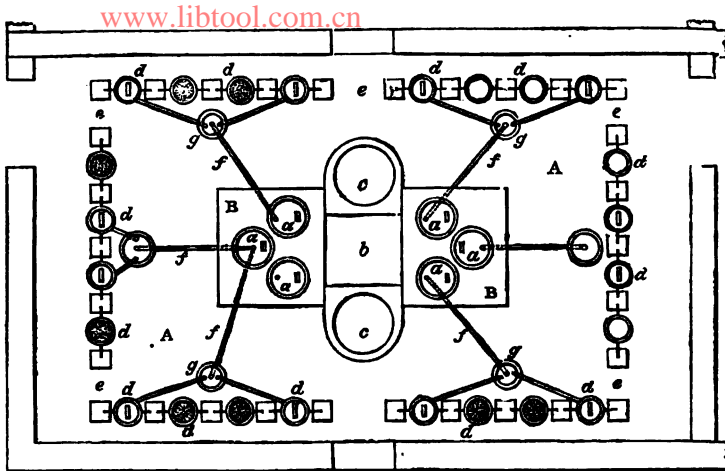

room provided with a drying hearth, on which the schlich is heated during the winter season up to 5° C., otherwise hydrate of chlorine would be formed in the solution vessels. A laboratory furnished with a small reverberatory furnace, some crucible furnaces, sand bath, and other requisites, is placed behind the store-room. On both sides of the store-room are apartments (A) (Fig. 187) for lixiviation purposes, 32 feet long and 20 feet broad; B, are hearths on which the chlorine gas is produced in the vessels, *a*, each having a separate fire-place communicating with the chimney, *b*; *c* are pans for warming water in winter time up to 25° C., which is used for moistening the schlich; *d* are pots for lixiviating the schlich, eight of which are placed in a long row and four in a short one. Each four forms a battery, and between each battery a passage *e* is left open leading to the hearth, B. The pot, *d* (Fig. 188), is formed of good clay,

www.libtool.com.cn

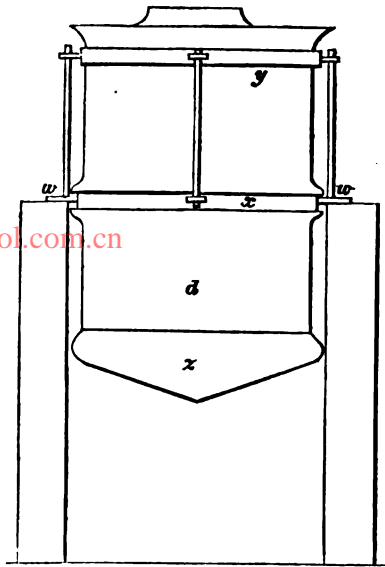

and surrounded by the iron hoops, *x*, having two plugs, *w*, by means of which the pots may be tilted over and emptied.

The semicircular rail, *y*, prevents accidental tilting over of the pots; the conical part (*z*) of the pot has an opening closed by a clay sieve; the top of the pot is closed with a wooden lid having a small circular hole. The pots *a* (Fig. 189) for the production of chlorine gas are closed with a lid

FIG. 189.

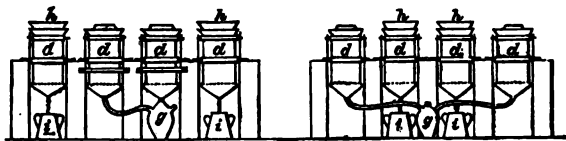

of lead, 25 lbs. in weight, and provided with one rectangular opening through which the materials are charged, and a round opening through which the lead tube, *f*, for conducting the gas is fixed; the lead tube is connected with the washing vessel, *g*, reaching to its bottom. Behind the compartments for lixiviation is another room, 34 feet long, intended for precipitation and filtration. For precipitation

It is provided with sand baths, each containing 20 vessels (common carboys). A small channel runs in front of the sand baths, and upon it the filtering apparatus are placed; the filtered liquid is conducted by the channels into sumps filled up with saw dust. This room also contains the minor apparatus required.

The operation is carried on in the following manner:—

At five o'clock in the morning the conical part of the pots, *d*, is filled with fragments of quartz, the clay sieve put into its place, and 24 pots are filled up with schlich to within 2 inches of their mouths; this is slightly moistened and warmed during winter; each pot contains  $1\frac{1}{2}$  cwts. of schlich. The vessels for producing chlorine gas are prepared for operation by fixing and luting their lids and tubes for conducting the gas. Each vessel is charged with 13 lbs. of muriatic acid, 7 lbs. of sulphuric acid diluted with an equal quantity of water, and 7 lbs. of binocide of manganese (pyrolusite); the charging opening is hermetically closed, and the sand bath heated. Besides chlorine, chloride of manganese is produced, from which chlorine is expelled by sulphuric acid. After chlorine has been passed through the vessels, *d*, for an hour, they are closed by lids, and, from time to time, a glass rod wetted with ammonia is held before the round opening of the lid to observe whether the chlorine which is introduced from below has permeated the schlich, which is indicated by the fuming of the moistened rod. The impregnation is finished in about six or seven hours, and the pots are well luted and kept closed till the following day. The chlorination of 24 pots is now commenced in another room, whilst the first 24 pots are lixivated. For this purpose the lids are removed and a wicker basket (*h*) (Fig. 189) is placed upon the pots (*d*) and the vessels (*i*) beneath; water of from  $17^{\circ}$  to  $25^{\circ}$  C. is rapidly poured upon the schlich in order to absorb free chlorine, and it is then again passed through the mass. Boiling water would absorb but little chlorine and dissolve more of the foreign salts. The lixiviation is interrupted when four vessels, or about 96 cubic feet of liquid have passed the 24 pots containing 36 cwts. of schlich. The first two vessels contain glass cylinders for

receiving the solution, as wood imbibes and decomposes chloride of gold in concentrated solution. The liquid of the fourth vessel is almost free from gold, and is therefore used for lixiviation the following day. The liquid of the first three vessels is drawn off by a syphon into glass carboys standing upon the sand bath, and the pots (*d*) are tilted over and emptied. The liquid warmed to 25° C. is treated with sulphuretted hydrogen gas produced from finely pounded lead matt and hot sulphuric acid, which is diluted with equal parts of water, thus first neutralising chlorine, and afterwards precipitating the gold as a sulphide until the liquid has a completely black appearance. The liquid is slightly warmed and the precipitate allowed to deposit; it is not completely deposited until the following day, when it is filtered.

When metals are used for precipitating the gold they are dissolved by the free chlorine, and if the chlorine is expelled by introducing steam, the liquid becomes too much diluted. The clear liquid from the carboys is slowly conducted by a glass syphon on to a paper filter lying upon pierced earthen dishes. The filtered liquid is conducted into sumps filled with saw dust to collect any sulphide of gold which may escape the filters; the deposits in the carboys are washed and poured upon the filters. Particles of sulphide of gold sticking to the syphons can be easily dissolved by some chlorine water. 320 filters with sulphide of gold are obtained in 16 days; they are then dried, carbonised in four large pans, boiled with aqua regia, washed, and the solution filtered into glass cylinders. Afterwards the filters are again boiled in water, and the gold is separated from the solution by sulphate of iron.

The four precipitates of gold are collected on two filters, washed first with pure dilute muriatic acid, and afterwards with water. When eight filters are collected they are carbonised, and the gold melted in Hessian crucibles with an admixture of borax and saltpetre; the bottoms of the crucibles are pounded, and if containing small grains of gold they are washed out. The crucibles are placed in a compartment separate from the fire-place, and are only heated by the flame of the fuel, thus avoiding losses by the breaking of the

crucibles. A lump of gold weighing several pounds may be melted in a quarter of an hour if the furnace has been previously heated for two hours.

About 500 tons of schlich are worked annually, consuming 25 tons of muriatic acid,  $7\frac{1}{2}$  tons of sulphuric acid, and  $12\frac{1}{2}$  tons of manganese, and producing from 20 to 21 lbs. of gold, in value from £1,200 to £1,350, whilst the cost of the production is from £750 to £900. The yield is better in summer than in winter, as in the latter season chlorine is more easily transformed into hydrochloric acid, which, if metallic sulphides are present, produces sulphuretted hydrogen gas, and the gold is then liable to become sulphuretted.

At Reichenstein, the production of gold is at present abandoned, as the old residues have been worked up, and the arsenic works do not produce more than 50 or 75 tons of auriferous residues annually, the working of which would not cover the interest of the outlay.

At Schemnitz, auriferous raw matt has been treated by Ziervogel's method (page 378), and gold extracted from the residues by Plattner's method. These residues contain :—

SiO <sub>3</sub> . . . . .	3·000
Fe <sub>2</sub> O <sub>3</sub> . . . . .	78·080
Fe <sub>2</sub> O <sub>3</sub> SO <sub>3</sub> (basic) . . . . .	15·730
SbO <sub>3</sub> . . . . .	2·780
AgO, SbO <sub>3</sub> . . . . .	0·120
AgS . . . . .	0·036
Ag . . . . .	0·030
Au . . . . .	0·012
Cu . . . . .	trace
	99·788

The apparatus is represented by Figs. 190 and 191. A is the apparatus for evolving chlorine gas. It is made of cast-iron, and furnished with the conduit-pipe, *a*, for cleaning the apparatus. B is a lead vessel screwed to A, and furnished with three conduit tubes, namely, *b* for charging the mixture, *c* for introducing sulphuric acid, and the conduit tube, *e*, connected with the tube, *f*, for emitting the chlorine gas. This gas first enters the washing vessel, *c*, then the receiver, *d*, whence it passes into the earthen lixiviation vessels, *e*, by

FIG. 190.

FIG. 191.

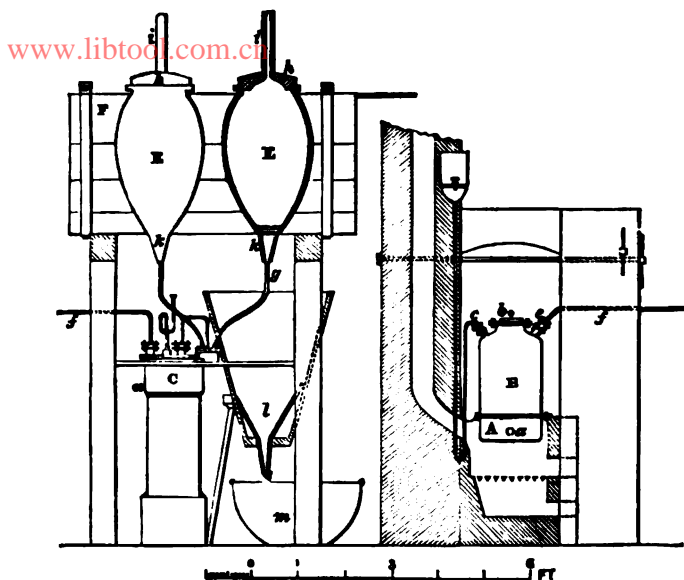

the two tubes, *g*. Two vessels, *E*, stand upon an elevated platform in a wooden box, *F*; the interstices are filled with beaten down sand. The vessels, *E*, have an opening at their lower parts, which are filled up to within two inches with fragments of quartz; they are closed with the earthen lids, *k*, and provided with the tubes, *i*, for emitting gases.

The residues are dried and moderately heated to decompose their basic iron salts; they are then slightly moistened and charged in quantities of 6 cwts. in each clay vessel. Chlorine is introduced through the tube, *k*, whilst the tube, *i*, is left open till chlorine gas escapes from it. It is then closed by a plug of clay, and the chlorine gas allowed to react for twelve hours. The chlorinated mass is next lixiviated with warm water, and the gold solution is conducted from the bottom tube, *k*, into the large glass vessels, *m*, by means of the funnel, *l*, after the removal of the tube, *g*, in which gold is precipitated by sulphate of iron. The clarified liquid is then decanted by a syphon, the precipitate of gold collected, washed, dried, and melted in a Hessian crucible with an

addition of borax and saltpetre. The liquid is collected in a reservoir and conducted over iron, thus yielding some auriferous cement copper. The extracted residues are mixed with lime and added to the ore smelting process (page 230).

The loss of gold amounts to 18.21 per cent.

#### **Calvert's Method of Treating Auriferous Quartz.—**

This method is based on the principle of the evolution of chlorine gas in the ore mass itself, as chlorine in the nascent state strongly attacks the gold. This method has also the advantages of cheapness, and of permitting the extraction of silver and copper at the same time; it is also less injurious to the health of the workmen. The mixture of finely pulverised quartz, with 1 per cent of manganese, is put into a vessel which may be closed, and which is provided with a pierced bottom; upon this bottom a layer of brushwood and then some straw are placed, muriatic acid is next added, and the liberated chlorine gas allowed to react upon the ore for twelve hours. Enough water is then added to fill up with liquid the space between the bottom and the false bottom of the vessel, and the liquid is repeatedly added to the ore. It is then tapped off and treated with iron to precipitate the copper; it is afterwards heated to expel the surplus chlorine, and the gold is precipitated by iron vitriol. If the ores contain silver at the same time, chlorine is evolved from a mixture of common salt, manganese, and sulphuric acid, mixing the ore with six parts of common salt and three parts of manganese. The chloride of silver formed is then dissolved in the solution of common salt, from which it may be precipitated by copper; afterwards the copper is precipitated by iron, and lastly the gold by iron vitriol.

**Chlorination of Auriferous and Argentiferous Substances, and Extraction of Gold and Silver at the same time.—**According to Plattner,\* an auriferous and argentiferous substance, when roasted with common salt, forms chlorides of silver and of gold ( $\text{AuCl}_3$ ). The chloride of gold is transformed into protochloride of gold ( $\text{AuCl}$ ), losing two equivalents of chlorine, when heated to somewhat below

\* Plattner's Röstprocesse, 1856, p. 274.



200° C, and the protochloride of gold is decomposed into chlorine and metallic gold when heated to about 240° C. This easy decomposition of the chloride of gold is a chief reason of the imperfect yield of gold when treating silver ores by the amalgamation process, or submitting them to a lixiviation with common salt. According to Janikovits,\* the chlorination is more securely effected if the ore, &c., is first roasted "dead" with an admission of steam, and afterwards submitted to a chlorination roasting at a lower temperature; Rösznert† states, on the other hand, that this chlorination roasting would form  $Au_2O_3$ ,  $NaO + NaCl$ , which combination is only slightly soluble in a solution of common salt, and is not decomposed by mercury; it cannot, therefore, be treated either by Augustin's process or by amalgamation. But both this salt and chloride of silver are soluble in hyposulphites, and moderately so in a mixture of a solution of common salt and chlorine water; by these reagents silver and gold may be extracted at the same time. The recent investigations of Max v. Lill‡ have proved, in accordance with Kiss's supposition, that the roasting process produces chloride of gold, which forms with hyposulphite of soda or lime a soluble double hyposulphite of gold and soda (according to Fordos and Gelis,  $AuO, S_2O_2 + 3NaOS_2O_2$ ). To prevent separation of metallic gold from the chloride of gold in the roasting process, the temperature must not be too high during the last roasting period, and some surplus chlorine, produced from common salt and easily decomposable metallic sulphates, must be present. It is advisable to wash the roasting mass with water previous to its treatment with hyposulphites. The chloride of gold, by the action of hot water, is decomposed into protochloride and metallic gold, and though insoluble in cold water is slowly decomposed by it in darkness.

We have before mentioned that Kiss's method of extracting gold and silver is based upon the solubility of chloride of silver and gold in a solution of hyposulphite of lime, but its

\* Oesterr. Ztschr., 1863, No. 30.

† Ibid., 1863, No. 211.

‡ Ibid., 1865, p. 49.

results have not been satisfactory with regard to the yield of metals. Experiments with Patera's\* and Rösner's† method, who first submit the substance to a chlorination roasting, and then treat it with a solution of common salt saturated with chlorine, have given better and very promising results. Silver ores from Arany Idka were experimented on by these methods, yielding 98·94 per cent of silver, all the copper and nearly all the gold, while the residues retained from 0·002 to 0·005 lb. These experiments proved that the expense of working 5 tons of ore by this method of extraction was less than when working them by the amalgamation process by £7 10s. 6d. (page 330).

Patera treats ores, &c., with a cold solution of common salt saturated with chlorine, thus chlorinating and dissolving silver and gold at the same time; a previous roasting with common salt is also admissible.

Rösner roasts the ores, &c., with common salt, and extracts the greater part of the silver from the roasting mass by Augustin's method, with a hot concentrated solution of common salt; the residues are then alternately treated by cold solution of salt saturated with chlorine, and hot concentrated solution of salt, to extract the gold and the remaining silver; both metals are precipitated from the hot solution by copper; the cement silver is cupelled, and the gold separated from the auriferous silver in the usual manner.

**Lixiviation with Sulphuric Acid.**—The yield from this method is larger when treating ores containing lead, copper, gold, and silver, which cannot be advantageously worked by the other methods. Ores containing a sufficient amount of sulphur are either completely roasted, and the escaping sulphurous acid collected for the production of sulphuric acid, or they are previously smelted to produce a matt, which must be perfectly roasted; copper and iron are then extracted from the roasted mass by dilute sulphuric acid, and the residue, containing gold, silver, and lead, is either fused with lead, or if containing no lead, its silver is extracted by

\* Oesterr. Ztschr., 1863, p. 165.

† Ibid., 1863. No. 25, 40.

residue is treated with aqua regia, and the gold precipitated by iron vitriol. If the ores contain no silver and lead, the residues of the extraction with sulphuric acid may be treated direct with aqua regia. In this way Allain and Bartenbach\* extracted the gold from pyrites with profit at Chessy. Stetefeldt† advocates a similar method for treating the Colorado ores containing lead, bismuth, copper, and gold. A similar process is adopted in Freiburg for the treatment of argentiferous copper matt, and in Oker for treating auriferous and argentiferous black copper.

In Transylvania the gold ores containing tellurium are treated according to Löwe's‡ method; they are first freed from carbonates by dilute muriatic acid, and then gradually mixed with three times their weight of concentrated sulphuric acid, which is gradually heated in an iron pan to the boiling point, till sulphurous acid ceases to be evolved. The mass is then poured into a leaden box filled with water acidified with muriatic acid, thus precipitating chloride of silver along with the undissolved gold, whilst tellurous acid is dissolved, and from its solution tellurium may be precipitated by zinc. The auriferous and argentiferous residue is worked up by fusion with lead.

## II. SEPARATING GOLD FROM SILVER.

As gold always occurs in combination with silver, the treatment of its ores produces an argentiferous gold or an auriferous silver, and before separating them, the mass must be purified from base metals, such as copper, lead, bismuth, &c.; this is usually effected by a kind of refining process. Palladium, platinum, &c., cannot be separated by refining, and when they are present, a somewhat modified process must be adopted.

The presence of platinum increases the amount of silver retained by the gold. Iridium and Osm-iridium are frequently contained in the Siberian, Californian, and

\* DINGL., Bd. 155, p. 53. Polyt. Centr., 1850, p. 109.

† B. u. h. Ztg., 1864, p. 384.

‡ ERDM., J. f. pr. Ch., Bd. 60, p. 163.

Australian gold, and lessen its value by diminishing its lustre and rendering it very brittle. Osm-iridium does not alloy with gold, but occurs in it in the form of grains and spangles, causing defects in coins and ornaments. The separation of gold from silver is now almost universally effected in the wet way.

### I. Separation of Gold from Silver in the Dry Way.

This is effected by means of grey antimony ore, by litharge and sulphur, or by cementation, but these methods only admit of an imperfect separation.

*a. Separation of Gold by Grey Antimony Ore.\**—This method is based on the affinity of sulphur and antimony to gold, antimony having the greater affinity. One part of granulated alloy containing at least 50 per cent of gold is fused in a crucible lined with charcoal, together with two parts of grey antimony ore, and then poured into cast iron moulds smeared with grease; an alloy of gold and antimony separates in the lowermost part of the moulds, and above it a combination of sulphide of antimony and silver, and of antimonide of gold, called *Plachmal* or *Plagma*.

The alloy of antimony and gold is heated under a muffle or by a blast, volatilising the antimony; the remaining gold is purified by smelting with a mixture of  $\frac{1}{2}$  part of borax,  $\frac{1}{4}$  part of saltpetre, and  $\frac{1}{4}$  part of powdered glass.

The *Plachmal* is re-melted as often as antimonide of gold becomes separated, and is then further treated either by litharge or iron for the extraction of its silver.

*b. Separation of Gold by means of Litharge and Sulphur.*—This process was formerly used in Okert† at the Lower Hartz, and at Kremnitz,‡ &c., to concentrate the gold in brightened silver in order to render the silver rich enough for the treatment with nitric acid (quartation).

Upon melting the alloy with  $\frac{1}{8}$ th part of sulphur, sulphide of silver is formed, while the gold remains disseminated in

\* ERDM., J. f. ök. u. techn. Chem., vi., 174.

† ERDM., J. f. pr. Chem., ix., 74.

‡ PRECHTL. Encykl., xii., 293.

the fused mass (1 or 1½ ozs. upon 1 lb. of silver) sulphide of lead is formed, and metallic silver sinks to the bottom and alloys with gold. By repeated treatment of the auriferous silver with sulphur and litharge, the amount of gold is concentrated in ¼th of the silver and is then extracted by nitric acid. Alloys containing lead are previously refined.

*Plachmal* still containing gold is repeatedly treated with litharge till all the gold is extracted, when it is desulphurised by iron (25 per cent) at a higher temperature, and the resulting argentiferous lead is cupelled.

**Extraction of Gold by Cementation.**—This mode of extracting gold from silver was formerly used (A.D. 1350) before nitric acid came in general use. It is still occasionally employed to make gold much alloyed with silver appear on its surface as fine gold.

The alloy is rolled to the finest plate and heated for twelve or eighteen hours with cement powder at a temperature slightly below the melting point. According to Philipp,\* a good cement powder consists of one part of common salt, one part of alum, one part of calcined iron vitriol, and three parts of powdered brick. The sulphuric acid is expelled from the vitriol and alum by the heat, and then liberates chlorine from the salt. The pulverised brick serves to increase the volume and to render the mass less compact. After cooling the vessels, the cement powder containing the chloride of silver is removed from the plates which are then boiled with water. The chloride of silver entering the mass of the cement powder probably combines with the chloride of sodium, forming a double salt, in consequence of which the surface of the plate is kept bright and permits the gas continually to react upon it.

Boussingault† states that the cementation is only perfect when air is admitted, and some steam present, when hydrochloric gas will be formed, chlorinating the silver whilst evolving hydrogen.

\* Bgwkfd., viii., 398; xiv., 535. B. u. h. Ztg., 1845, p. 347. Pogg., xxxii., 99. DINGL., Bd. 119, p. 157.

† ERDM., J. f. pr. Ch., ii., 155.

He\* also states that this mode of cementation was in use thirty years ago at the mint at Santa Fé in New Granada.

[www.libtool.com.cn](http://www.libtool.com.cn)

## 2. Separation of Gold from Silver in the Wet Way.

This mode of separation is more perfect, simpler, and cheaper, than the separation in the dry way, and may be performed by means of nitric acid, sulphuric acid, or aqua regia.

*a.* **Separation of Gold by means of Nitric Acid (quartation).**†—If silver and gold are combined in a certain proportion, the silver will be dissolved by nitric acid, whilst the gold is unattacked. The proportion sanctioned by experience is three parts of silver and one part of gold, but this proportion is not indispensable; moreover an alloy of  $2\frac{1}{2}$  parts of silver and one part of gold leaves, according to Chaudet‡ and Kandelhardt, less silver in the gold than the usual proportion of three to one; and the greater the proportion of silver in the gold the more difficult it is to obtain gold free from silver.

According to Pettenkofer|| the separation of both metals answers well if they are alloyed in the proportion of one part of gold to  $1\frac{3}{4}$  parts of silver, if the strength of the acid is judiciously chosen, and if the boiling is continued sufficiently long. The larger the proportion of silver in the alloy, the greater the division of gold in the alloy, and the more silver will remain undissolved; this silver cannot be removed either by concentrated nitric acid or by long continued boiling.

An alloy too rich in gold must be fused with silver, and if too poor in gold, it must be concentrated.

The alloy of proper composition is granulated and heated with nitric acid in a glass cucurbit; the remaining pulverulent gold is washed, dried, and melted in a Hessian crucible

\* ERDM., J. f. pr. Ch., ii., 156.

† PRECHTL., techn. Encykl., xii., 293.

‡ CLAUDET, l'Art de l'Essayer.

|| Bgwkfd., xii., 6.

with borax and saltpetre. After its nitric acid has been distilled from the solution of silver, it is boiled to dryness; the dried mass is strongly heated and smelted for the production of metallic silver. Sometimes nitrate of silver is decomposed by copper.

This method is complicated, and costly, on account of the expense of nitric acid; and as also the manipulation in glass vessels is objectionable, this method is almost entirely superseded by the separation with sulphuric acid, but it is still used for assaying auriferous silver.

According to Newton,\* gold so poor in silver as to require to be fused with a considerable quantity of silver may be treated in the following manner, in order to avoid the quartation. The alloy must be treated with aqua regia, which is produced from a mixture of soda-saltpetre, sulphuric acid, and common salt; thus gold will be dissolved, and chloride of silver remain. The gold is then precipitated in the metallic state by iron vitriol, and the mixture of metallic gold and chloride of silver is treated with sulphuric acid and zinc, transforming the chloride of silver into metallic silver; the silver is then extracted from this mixture of gold and silver by nitric acid, or the argentiferous gold is fused with two or three times its weight of zinc; it is then stirred, and the formed alloy granulated and treated with dilute sulphuric acid in wooden vessels coated with lead. The remaining finely divided argentiferous gold and silver are washed, and the silver is dissolved either in sulphuric acid or in nitric acid.

Johnson† separates gold from the Brazilian alloy of palladium and gold by melting it with  $2\frac{1}{2}$  parts of silver, and by treating the granulated alloy with nitric acid, when silver and palladium dissolve whilst gold remains.

Petrie‡ has essentially improved the method of quartation by arranging the vessels in terraces, and by employing a galvanic current whilst precipitating the silver.

\* Bgwkd., xv., 749. B. u. h. Ztg., 1852, p. 880.

† ERDM., J. f. pr. Ch., xi., 309.

‡ Polyt. Centr., 1853, p. 1244.

**b. Separation of Gold by means of Sulphuric Acid.**—This method,\* first proposed by Schraubert in Moskau, was adopted in 1802 by D'Arcet, who employed platinum vessels. This method is based upon the insolubility of gold, and the solubility of silver in boiling concentrated sulphuric acid. It is preferable to quartation with nitric acid, being simpler and cheaper, and permitting the treatment of alloys containing almost any amount of gold. The manipulations require great accuracy to guard against any loss of noble metals, materials, and time.

According to Pettenkofer,† the gold is finest when produced from alloys, sixteen parts of which contain little more than four parts and little less than three parts of gold, the remaining parts being silver and copper.

If more than four parts of gold are present, mechanical difficulties will arise, as the gold remains too compact, preventing the sulphuric acid from sufficiently permeating the alloy, and the last traces of silver cannot be completely extracted. If the amount of gold is less than 1 or  $\frac{1}{2}$  part in 16 parts no fine gold results, and the less gold the alloy contains the less perfectly can the gold be freed from silver by sulphuric acid; the silver must amount to at least  $\frac{4}{5}$ ths of the alloy. At the mint in St. Petersburg the proportion of one part of gold and  $2\frac{1}{2}$  parts of silver is found to be more suitable for the action of sulphuric acid than the proportion of one to three. 0·1 or 0·2 per cent, and even less, of gold can often be profitably extracted.‡ In Freiberg, alloys are treated containing from 0·04 to 0·08 per cent of gold, 6½d. per lb. of auriferous silver representing the expense for extracting the gold. In the mint at Vienna silver containing about 0·09 per cent of gold is profitably treated. The old French silver coins contained 0·2 per cent of gold.|| Alloys usually dissolve more readily and consume less acid the less copper they contain; the presence of lead hinders

\* PRECHTL. techn. Encykl., xii., 293. ERDM., J. f. pr. Ch., ix., 49. HARTM., Repert., ii., 638. ERDM., J. f. ok. u. techn. Ch., i., 29, 128, 490, 505; iv., 410.

† DINGL., Bd. 104, p. 118. Bgwkfd., xii., 3.

‡ ERDM. J. f. pr. Ch., xii., 406.

|| SCHUBARTH, techn. Chem., 1851, ii., 353.



the solution; the presence of 0·75 per cent of copper and 0·25 per cent of lead at the highest is said not to impede the separation.

Alloys richer in lead and copper must therefore be previously purified from these metals; this purification may be effected—

1. By a so-called fine smelting with saltpetre,\* in which the lead and copper become scorified; but this mode can only be advantageously applied to alloys of a certain fineness, and containing a certain amount of gold, as a large addition of saltpetre will melt the crucible, and as, on the other hand, the slag becomes auriferous if the alloy is too rich in gold. Experience proves that 100 parts of copper require 48 parts of saltpetre, thus yielding a fineness of from 973 to 979.

The alloy is melted with saltpetre in a Hessian crucible standing in a plumbago crucible. The slags are either skimmed off with a perforated ladle, or they are removed when still soft from the solidified regulus. Upon smelting the slags with  $\frac{1}{3}$ rd of potash some silver is still produced.

An oxidation smelting of the silver in a reverberatory furnace has given in the mint at St. Petersburg† a better result than smelting with saltpetre.

2. The alloys may be purified by heating them to redness, and treating with sulphuric acid.‡ Alloys rich in copper are granulated and heated in a reverberatory furnace to superficially oxidise the copper; they are then boiled with dilute sulphuric acid in leaden vessels, thus dissolving the oxide of copper. The process must be repeated several times in order to obtain silver of the intended fineness. This method saves a considerable quantity of sulphuric acid, as metallic copper requires more acid to dissolve it than oxide of copper. Some silver will also become oxidised, but it will not dissolve before all the oxide of copper has entered into solution.

3. Plumbiferous silver from the smelting works is usually

\* ERDM. J. f. pr. Ch. i., 245. DUMAS, *Angew. Ch.*, iv., 453.

† Oesterr. Ztschr., 1857, p. 205.

‡ DUMAS, *Angew. Chem.*, iv., 455. SCHUBARTH, *techn. Chem.*, 1851, ii., 334.

submitted to an oxidation smelting in a reverberatory furnace; in the mint of St. Petersburg the hearth consists of three parts wood ash and one part bone ash.

4. According to Mascazzini,\* the purification may be effected in the following manner:—The alloy is finely divided by Rostaing's apparatus,† and is treated with sulphate of mercury and water in earthen vessels heated by steam, thus dissolving copper, antimony, tin, &c.; the residue is repeatedly washed, moderately heated, and melted with borax and salt-petre. This method is simpler than cupellation, and the volatilisation of silver is less.

The separation of gold by means of sulphuric acid requires the following manipulations:—*a.* A division of the alloy by pounding or granulating to accelerate the solution in acids. To granulate silver it is melted in crucibles of plumbago or of wrought iron, or the fusion is effected in reverberatory furnaces. Cast-iron crucibles gradually become porous and cause loss of silver. The fused silver is poured in a thin jet into a copper pan with a double bottom, in which cold water is kept rotating by means of a broom. The grains fall through a hole in the bottom of the inner pan, and collect upon the outer bottom, and so do not impede the stirring of the water.

Newton‡ finely divides the argentiferous gold by fusing it with two or three times its weight of zinc, then granulating the mixture and treating it with dilute sulphuric acid, when the argentiferous gold will remain in a finely divided pulverulent state.

*b.* The finely divided alloy is dissolved in hot concentrated sulphuric acid. In Munich this is effected in vessels of platinum; in Vienna, in gold vessels; in Vienna, Munich, Kremnitz, St. Petersburg, Frankfort, Hamburg, &c., cast-iron vessels are also used, and in Oker, vessels of porcelain. The use of dilute acid impedes the solution, and is also injurious to the platinum vessels if the alloy contains any lead, as sulphate of lead will then deposit and perforate the vessel.

\* DINGL., Bd. 161, p. 43.

† B. u. h. Ztg., 1860, p. 216; 1863, p. 168.

‡ Bgwkd., xv., 672.

Weak sulphuric acid taken from the lead chambers usually contains muriatic acid and nitrogen compounds, which also attack platinum. Cast-iron is only slightly attacked by concentrated acid.

One equivalent of silver requires two equivalents of concentrated sulphuric acid for solution, one equivalent oxidising the silver, and the other combining with the oxidised silver—



Therefore 100 parts of silver require 90 parts of hydrated sulphuric acid; but, in practice, more sulphuric acid is used (2 or  $2\frac{1}{2}$  parts to 1 part of silver) to dissolve the pasty sulphates, which would otherwise enclose the alloy and impede its solution. The surplus acid in the liquid is either again rendered fit for this solution process by concentration, or it is saturated with a metallic oxide to produce vitriol.

This process yields the following products:—

1. **Gold**, which collects on the bottom of the vessel in a pulverulent state. It is usually repeatedly boiled in the solution vessel, or in a smaller vessel of platinum, gold, or iron, with concentrated acid, till it is sufficiently fine; but the gold obstinately retains the last particles of silver (up to  $2\frac{1}{2}$  or 3 per cent), especially when platinum is also present. According to Pettenkofer,\* gold extracted from Crown dollars very readily attains a fineness of 958 or 960; but much sulphuric acid and a continued boiling are now required to increase the fineness by 6 or 10. The fineness attained by boiling the gold fourteen times only amounted to 970, and an analysis proved the gold to contain 97 per cent of gold, 2·8 per cent of silver, and 0·2 per cent of platinum.

The last 2 or 3 per cent of silver in the gold, which cannot be extracted by means of sulphuric acid, is not attacked by a solution of chloride of iron, nor changed into sulphide of silver when in contact with sulphur, but it may be transformed into sulphate in silver by a fusion with acid sulphate of potash or soda, and the silver vitriol then washed out from the gold. The soda salt is preferable to the potash salt, as it is cheaper, its equivalent weight smaller, and it dissolves more readily in water.

\* Bgwkfd., xii., 4, 5; xiii., 180 (Anmerkung).

The fusion is performed in the following manner:—The dried and pulverised gold, containing 4 per cent or more of silver, is mixed with  $\frac{1}{4}$  of its weight of pure calcined Glauber's salt; the mixture is put into a small iron pan, and 6 or  $6\frac{1}{2}$  parts of concentrated sulphuric acid, corresponding to every 10 parts of Glauber's salt, are added in separate portions; after the first addition of acid the pan is heated so as to fuse the mass. When sulphuric vapours cease to escape, and the mass has become dry, it is removed from the fire; it contains no neutral soda salt. It is next mixed with the same quantity of sulphuric acid as was used in the first treatment, thus completely oxidising the silver, but it is only heated long enough to convert about half the salt into a neutral salt. The mass is then boiled with a larger quantity of sulphuric acid, thus dissolving the soda salt as well as silver salt; the solution is decanted from the gold, and the gold is washed in the usual manner. Gold once treated has a fineness of 994 after being melted with saltpetre, and a fineness of 998 or 999 after a second treatment; the copper-vitriol is not contaminated with Glauber's salt.

At Oker, the extracted gold was formerly boiled seven or eight times with sulphuric acid, thus fining the gold to 986. Gold melted with acid sulphate of soda whilst adding some sulphuric acid, and then re-melted with saltpetre and borax, attained a fineness of 993. At present gold is only boiled twice with sulphuric acid, then washed and melted in a Hessian crucible with an addition of borax, yielding gold of a fineness not below 900.

Gold obtained by extraction is never sufficiently fine, soft, or ductile, unless melted in a clay or plumbago crucibles, with an addition of saltpetre. In the mint at St. Petersburg this re-melting is effected in a small reverberatory furnace with a sump, to save the expense of crucibles and to diminish the unavoidable loss of metal. The volatility of gold makes it advisable during melting to keep its surface covered with a layer of charcoal or bone-ash. Napier's\* investigations of the fume from the melting of noble metals have proved that their volatilisation is greater than is generally supposed;

\* B. u. h. Ztg., 1860, p. 496.

some fume contained as much as 4 per cent of gold; gold alloyed with silver is less volatile than when alloyed with copper; melted gold is best poured into iron moulds which have been previously warmed and brushed with grease or wax.

**Extraction of Iron, Tin, Antimony, Arsenic, and Lead.**

—In the mint of the United States,\* ferruginous gold is melted with a mixture of sulphur, and carbonates of potash and soda; tin, antimony, and arsenic are removed by melting with borax, soda, and saltpetre, or according to Warrington,† tin and antimony may be extracted by melting the gold for half an hour with one-tenth of its weight of oxide of copper and some borax. Lead may be removed by melting with saltpetre and sand, or a little chloride of mercury enveloped in paper is repeatedly thrown into the mass fused with saltpetre and borax, until a sample taken shows sufficient ductility. 0.02 per cent of lead renders gold brittle.

Pettenkofer‡ states that almost all extracted gold contains a small amount of platinum, from which it may be freed as oxide of platinum and potash by melting with saltpetre. This amount of platinum not only retains silver in gold, but causes a considerable loss of gold when melting it with saltpetre. Whilst finely divided gold when melted with saltpetre oxidises with more difficulty than platinum, it oxidises most readily in the presence of platinum, forming slags containing as much as 19 or 20 per cent of gold and  $2\frac{1}{2}$  or  $3\frac{1}{2}$  per cent of platinum. If the gold also contains silver, the silver protects the platinum from oxidation, and the platinum then enters the argentiferous gold. All the platinum will enter the slags if the gold contains not more than 0.5 per cent of silver, and not more than 0.3 per cent of platinum. Besides the potash of the saltpetre, the slags contain all the metals which were attacked at the previous treatment with sulphuric acid, and transformed into insoluble salts (sulphate of lead, sulphide of copper, basic sulphate of iron); some components of the crucible (silica, alumina, lime), also enter the slags, and metallic

\* Polyt. Centr., 1853, p. 1127.

† Ibid., 1861, p. 283.

‡ Bgwkfd., xii., 38; xiii., 177. B. u. h. Ztg., 1847, pp. 710, 745.

oxides formed by the reaction of the saltpetre upon the metals (oxides of gold, platinum, palladium, osmium). Some fine gold and some silver grains are also mechanically included, owing to the great viscosity of the slags.

Experience shows the best admixture for smelting to be 16 parts of gold with 1 part of saltpetre, when the resulting slags will weigh about as much as the saltpetre employed. The average loss of gold by the slags is 1 per cent when using saltpetre in that proportion; an addition of borax renders the slag more liquid.

The whole of the small amount of platinum in the gold usually enters the slag.

The amount of gold grains in the slag depends chiefly on the quantity of gold melted. If larger quantities of gold are melted in one charge, the relative and absolute amount of gold in the slags will always be much larger than when melting the same quantity in different operations; it is best to melt exactly 10 lbs. in one operation, as when employing crucibles of equal size the tough slag stands higher in the crucible than when melting smaller quantities. The higher the slag stands in the crucible the more the sinking of the gold grains is impeded. Sometimes a skin, consisting of fine grains of metallic gold, is formed on the lower side of the slag, caused by the sinking of gold grains after the temperature has decreased below the melting-point of gold, whilst the slag is kept liquid; the gold grains cannot then unite either with each other or with the gold below. When melting small quantities of gold the slag formed is also proportionally thinner, retaining fewer grains of gold for that reason. The crucible is liable to corrosion by the potash present, when trying to render larger quantities of slag more fluid by a continued firing.

The reverse takes place with any silver in the slags. The particles of silver still contained in the gold remain suspended in the slag together with some gold, owing to the light specific gravity and the fine distribution of silver, and they sink more slowly the thinner the slag is. Therefore one and the same quality of gold alloy will yield gold of

greater fineness (by 0·001 or 0·002) when melted in larger quantities than when melted in smaller lots.

To extract gold and platinum from the slags, Pettenkofer recommends that they should be mixed with water to a thin paste, and then added to a mixture of two parts of litharge, one part argol, four parts soda, and two parts pulverised glass to every eight parts of dry slag. The mass is thoroughly mixed and then dried in an iron or copper pan, and melted in a crucible previously heated red hot. The resulting raw lead is cupelled, yielding brightened silver, which is granulated and treated with aqua regia in a glass cucurbit. After solution, heat is continued to expel the nitric acid; chlorides of silver and lead are filtered off, and the gold is precipitated from the liquid by iron vitriol; it is then washed, dried, and fused with saltpetre in a Hessian crucible. The remaining liquid contains the platinum, and is warmed with iron, thus precipitating various metals; these are boiled with nitric acid, leaving platinum as a residue. This platinum is dissolved in aqua regia, and extracted by ammonia, &c.

This method of extracting gold and platinum, partly in the dry way, is preferable to employing the wet way\* exclusively.

When re-melting gold containing osmium-iridium, the osmium-iridium will sink to the bottom, owing to its great specific gravity; therefore Californian gold, containing about 0·1 per cent of osmium-iridium, is melted, at the mints in Philadelphia† and New York,‡ with two or three parts of silver, thus lessening its specific gravity; the specific gravity of the resulting gold alloy is from twelve to thirteen, whilst that of osmium-iridium is nineteen. On stirring the fused mass for some time the osmium-iridium will settle to the bottom; the contents of the crucible (8 or 10 lbs.) are ladled out till within one inch from the bottom, and granulated. The remaining metal, rich in osmium-iridium, is repeatedly melted with silver, thus concentrating the osmium-iridium more and more; 60 lbs. of silver are added at each of the last four or

\* Bgwksfd., xiii., 185.

† Ann. d. min., 5 sér., vi., 518. Polyt. Centr., 1855, pp. 278, 1180.

‡ B. u. h. Ztg., 1862, p. 256.

five meltings; after stirring, the mass is allowed to settle for some minutes and ladled out, leaving 10 lbs. of metal in the crucible, from which the silver is extracted by sulphuric acid, whilst the separated gold is washed out, leaving the osm-iridium. As gold containing osm-iridium entails more working expenses it is sold at a cheaper price.

Gold containing osm-iridium from Bogoslowk is melted, at the mint in St. Petersburg,\* in a large plumbago crucible, the gold is carefully ladled out till within 1 or  $1\frac{1}{2}$  inch of the bottom, and the remainder contains the osm-iridium, amounting to about 5 lbs. from several meltings. These 5 lbs. are then melted in a small plumbago crucible with a narrow bottom, and after cooling, the lower part of the metal regulus, consisting of osm-iridium with a little gold sticking to it, is cut off; this gold is dissolved in aqua regia, which does not attack osm-iridium.

The dross resulting from the treatment of Californian and Australian gold, containing gold, silver, and osm-iridium, is melted with a reducing and purifying flux containing litharge, thus producing raw lead, which is cupelled, yielding an alloy from which the silver is extracted; an alloy remaining of gold and osm-iridium.

According to d'Hennin,† the separation is best effected by smelting 12·5 parts of dross with 15 parts of black flux, 14 parts of chalk, 2·5 or 3 parts of arseniate of soda, 20 parts of borax and carbon, and some litharge and argol. Auriferous and argentiferous lead then result, and on the top of them a mass, consisting of arsenic, iron, and osm-iridium, which can be easily separated from the lead and cupelled.

Palladium‡ may be extracted from argentiferous gold by means of nitric acid.

2. **Sulphate of Silver**, dissolved in sulphuric acid, is carefully separated from the gold, and decomposed by copper.

3. **Sulphurous Acid**, formed by the oxidation of silver at

\* Oesterr. Ztschr., 1857, p. 206.

† Polyt. Centr., 1855, p. 1069. Oesterr. Ztschr., 1857, p. 211.

‡ Polyt. Centr., 1853, p. 1127.



the expense of sulphuric acid, is sometimes (Vienna, Paris) used for the production of sulphuric acid.

c. **The Extraction of Silver from Sulphate of Silver.**—When solidified, silver vitriol assumes a pasty crystalline form; it is placed by means of iron spatulas into leaden pans filled with hot water; according to Mitscherlich 88 parts of boiling water dissolve 1 part of sulphate of silver. After dissolving the vitriol by continually stirring it with a wooden rod, the silver is precipitated by means of strips of copper plate suspended in the solution, which is continually stirred and heated. 100 parts of silver require 29 parts of copper for precipitation, yielding 115 parts of crystallised copper vitriol ( $\text{CuO}, \text{SO}_3 + 5\text{HO}$ ); if silver is contained in the copper plate it will also be extracted by this operation.

The precipitation of silver is quickest, when the liquid possesses a specific gravity of  $25^\circ \text{B.}$ ; if concentrated up to  $28^\circ \text{B.}$ , the precipitation is imperfect, and the liquid shows a peculiar sparkling of separating crystals of silver vitriol, and an addition of water is required. When chloride of sodium ceases to precipitate silver from the liquid, the process is finished. The copper strips are removed, the silver allowed to settle to the bottom, and the solution of copper vitriol is tapped off by a leaden syphon.

The pan for precipitation is usually heated by direct firing; lately steam\* has also been used, either by conducting it directly into the solution, or by passing it through the liquid by means of a worm tube.

The precipitated silver is usually washed on a copper sieve, standing in a second sieve which is covered with linen, paper, &c. This washing with hot water is continued until prussiate of potash no longer reacts upon the wash water.

To shorten the time for drying the precipitated silver, and to prevent particles of silver being carried off with the steam, the silver is pressed by screws or by hydraulic pressure, and the resulting cakes are dried on a hot iron plate (Oker), in chambers heated by steam (Frankfort), or in a reverberatory furnace with an iron bottom (Vienna).

\* Bgwkfd., xii., 3, 41.

The silver is then melted in iron or fire-clay crucibles, usually with an addition of saltpetre to remove any copper present; ~~cast-iron crucibles~~\* are safer, quicker, and cheaper; at Oker, they are strongly heated when new, as otherwise they melt more easily, and hot iron hoops are fixed round the cold crucibles to increase their durability. As from their porosity cast-iron crucibles imbibe silver, lead is melted in them as soon as they crack and become unfit for silver smelting; the lead absorbs the silver, and passes through the cracks into a vessel placed below. Wrought iron crucibles† are also recommended, but they laminate easily after being repeatedly heated, unless made of charcoal iron.

The removal of the cupriferosus slag is facilitated by spreading some powdered brick upon the fused mass. If the silver is plumbiferous, and fumes after the slag has been removed, one part of saltpetre is thrown upon the fused surface, and shortly afterwards two parts of borax and one part of powdered brick. If the silver contains a large amount of lead, a layer of two parts ground bone and one part washed wood ash is placed inside, round the sides of the crucible, leaving an opening in the middle. This layer or rim, imbibing the oxide of lead formed, must be frequently stirred and renewed till the fuming of the metal ceases; during the melting silver shows a peculiar bubbling, which causes loss, but no means are known of avoiding it.

The produced silver has a fineness of from 928 to 997. Barruel‡ states that silver is rendered very hard by an admixture of 0·6 per cent of foreign substances, namely, 0·35 per cent of iron, 0·2 per cent of cobalt, and 0·05 per cent of nickel. The liquid containing copper vitriol and free sulphuric acid, is either saturated with cupriferosus substances, and boiled down for the production of copper vitriol, or the vitriol is extracted direct, washed, and re-crystallised; the resulting acid liquid is concentrated in a

\* B. u. h. Ztg., 1843, p. 406.

† Ibid., 1853, p. 455; 1864, p. 274. DINGL., Bd. 127, p. 36.

‡ Pogg., lxxxviii., 176.

lead pan to 58° B., and afterwards concentrated to 66° B. in either platinum or iron vessels, and again used for dissolving silver. When iron pans are employed they must be provided with a leaden head for carrying off the evaporated water, and preventing its contact with the sides of the pan.

The slags resulting from the silver smelting are pounded, and the intermixed grains of silver are sorted by hand. The remaining powder is smelted with potash, forming a regulus, which is added to the original silver smelting process. Dross formed when separating deposits of silver from the crucible by means of a sharp iron, slags from the smelting of silver slags, &c. are smelted either alone with borax and saltpetre, or together with litharge and glass, forming a regulus which is afterwards cupelled.

#### Parting of Gold in Platinum Vessels.

The parting of gold by means of sulphuric acid has been greatly developed by the employment of platinum vessels,\* though on account of their great expense they are at present but little used, and cast-iron vessels are almost universally employed. Platinum vessels resist perfectly the reaction of hot concentrated sulphuric acid, but being very expensive to make and to repair, and being liable to considerable waste from the friction of the granulated metal on their sides, they require to be treated most carefully. At the moment when the finely divided gold, in contact with the platinum is exposed to the influence of the boiling acid, the gold cakes and sticks so fast to the platinum that it must be dissolved with dilute aqua regia, if slight blows on the outside of the vessel are not effective. This operation requires much dexterity. Above all, platinum must not be exposed to contact with lead and tin, as they readily alloy with it at the temperature of boiling sulphuric acid. The platinum vessels are usually placed in iron jackets or frames.

\* PRECHTL., *technol. Encyklop.*, xii., 319. ERDM., *J. f. ök. u. techn. Chem.* iv., 411, 424. ERDM., *J. f. pr. Ch.* ix. 49.

At the mint in Munich platinum vessels about  $9\frac{1}{2}$  inches high, furnished with a platinum head 5 inches high, and  $9\frac{1}{2}$  inches in diameter, were formerly used; these vessels were placed in an iron frame; at present iron vessels are used.  $82\frac{1}{2}$  lbs. of auriferous silver, containing about 15 $\frac{1}{2}$  per cent of gold are treated in three platinum vessels, each containing  $26\frac{1}{2}$  lbs., with 173 lbs. of concentrated sulphuric acid. The vessels are heated first with wood and afterwards with turf.  $2\frac{1}{2}$  times as much sulphuric acid is employed as there is silver and copper in the alloy. The heads of the vessels communicate with a leaden tube, partially filled with water, in which any escaping sulphuric acid condenses. The surplus sulphurous acid is conducted into the chimney by means of a leaden tube.

The solution is finished in three hours, when some dilute sulphuric acid of 55° B. is added to precipitate the suspended particles of gold; after slightly cooling in a tilting apparatus, the greater part of the sulphate of silver is poured into a platinum vessel, leaving the gold at the bottom.

If the solution is not quite clear, it is re-heated with an addition of dilute sulphuric acid, and finally poured into the leaden precipitation pan, which is filled to one-third with water. The last auriferous muddy liquid is put into a smaller lead pan and decomposed by means of copper; the resulting silver, alloyed with gold, is then smelted and added to the next extraction. The gold remaining in the solution vessel is boiled three or four times with sulphuric acid; and the acid of the last boiling is used for dissolving auriferous silver. The gold is washed, dried, and melted without any addition; the washing water is filtered into the precipitation pan. The lixivium of silver vitriol is concentrated to about 25° or 27° B., and decomposed by copper; 100 parts of silver requiring 30 parts of copper plate. The precipitated silver is washed, dried, and melted in a Hessian crucible standing within a plumbago crucible; some saltpetre is added to each spoonful of charged precipitated silver. The resulting silver has usually a fineness of 995.5. The resulting lixivium of copper vitriol is concentrated to 32° or 34° B.,

and allowed to crystallise; the remaining mother liquor is boiled down to 36° B. and re-crystallised, and the second mother liquor is boiled down to 56° B. in a leaden pan, and to 66° B. in a platinum pan, when it is suitable for dissolving auriferous silver.

At St. Petersburg,\* platinum vessels were formerly used; four parts of sulphuric acid were added to every three parts of silver contained in the alloy. One extraction was performed in from six to ten hours. The resulting gold was boiled once more with sulphuric acid, and contained, when smelted, 99·666 per cent of gold, and the silver was of a fineness of 99·15.

Cast-iron vessels are now used there.

#### Parting of Gold in Porcelain Vessels.

These vessels are well fitted for the parting of gold on a small scale, on account of their cheapness; they permit great cleanliness, and if carefully treated are sufficiently durable.

At Oker in the Lower Hartz, the quartation method was formerly employed for extracting gold from auriferous silver produced by the lead and copper smelting. The refined silver contained from 993 to 996 of fine silver, and from 1·062 to 2·557 gold in 1000 parts. The cost of refining 1 lb. of gold by this method was from £12 12s. to £16 16s., whilst the present method costs only from £7 16s. to £10 10s. per lb. of gold. The apparatus used for refining gold is shown in Fig. 192. *a*, is an iron kettle suspended over the fire-place, *b*; *c*, is the porcelain vessel for receiving the auriferous silver and sulphuric acid, it is suspended in the kettle, *a*, by means of the iron basket, *d*; *e* is a porcelain lid closing the vessel, *c*, and kept tight by water; it is furnished with two openings, *f* and *g*. *f* is the working opening, and *g* the opening for receiving the porcelain tube, *h*, which is kept tight upon the lid by means of water; this tube is connected with the lead tube, *i*, and serves for carrying off the sulphurous acid produced by the process.

\* Polyt. Centr., 1853, p. 151. LAMPAD., Fortschr., 1839, p. 132. ROSE'S Reise nach dem Ural, Bd. 1., pp. 55, 625.

FIG. 192.

[www.libtool.com.cn](http://www.libtool.com.cn)

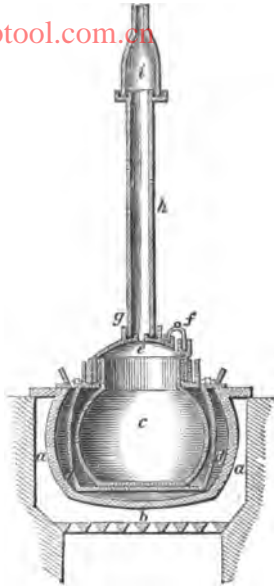

The granulated silver is treated in quantities of 12 lbs. with 28 lbs. of concentrated sulphuric acid. This quantity is dissolved in from 5 to 8 hours, employing a wood fire. When the hissing noise ceases the solution is complete, and no silver can be detected by means of a spatula introduced into the vessel *c*, through *f*. Two hours later, during which time the fire is still kept up, the sides of the vessel are rinsed with dilute sulphuric acid, and after heating the vessel for one hour more the gold is allowed to deposit at the bottom for five hours. The solution of silver vitriol is decanted into a moveable leaden pan. Fresh silver is then added to the residue of gold and the process repeated.

The remaining gold is twice boiled in a porcelain vessel with concentrated sulphuric acid, washed, dried, melted in a Hessian crucible with an addition of borax and saltpetre, and poured into a warm iron mould rubbed with wax. The gold must not contain less than 900 parts of fine gold in a thousand.

The solidified silver vitriol, resulting from 100 lbs. of silver,

is dissolved in hot water in a leaden pan 5 feet 8 inches long, 2 feet 6 inches broad, and 1 foot 6 inches deep. The solution, concentrated to about 25° B., is decomposed by copper plates in six or seven hours. The remaining acid solution of copper vitriol is saturated with copper, and used for the production of copper vitriol.

The precipitated silver is washed, pressed between pieces of linen in an apparatus, dried, and melted in quantities of about 500 lbs. in cast-iron crucibles. The apparatus used for pressing the silver is represented by Figs. 193, 194, 195, and 196. *a* is a cast-iron cylinder with a grooved bottom, *b*, upon which the precipitated silver, enclosed in linen, is

FIG. 193.

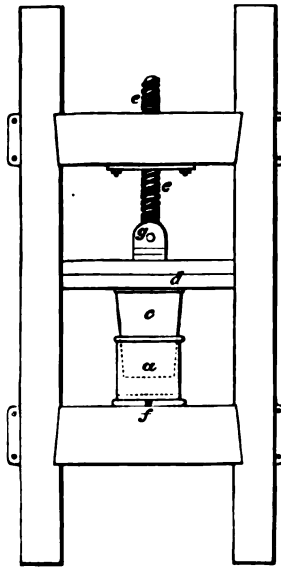

FIG. 194.

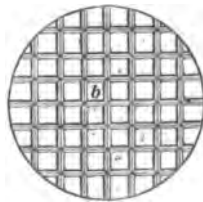
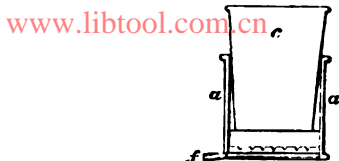
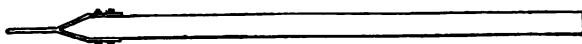

FIG. 195.



placed. The silver is pressed by means of the wooden cone, *c*, as the screw, *e*, is turned upon the boards, *d*, which press upon that cone. The screw is turned at *g* by means of the rod shown in Fig. 196. The water flows out at *f*.

FIG. 196.



The melted silver must not contain less than 990 parts of fine silver in 1000. A loss of 1.25 parts is allowed in this process for every 1000 parts of auriferous silver.

The richer dross is annually smelted in a plumbago crucible with an addition of litharge and glass; the resulting plumbiferous regulus is refined and returned to the extraction process. The poor dross is washed and smelted every three years in a cupola furnace, together with litharge and copper ore slags, producing raw lead, which is cupelled, refined, and submitted to the extraction process.

#### Parting of Gold in Cast-iron Vessels.

Cast iron vessels resist the reaction of concentrated sulphuric acid, as iron in contact with it becomes passive, or electro-negative. Air must be excluded as far as possible from iron vessels, and a dilution of the sulphuric acid must be avoided, otherwise iron will be dissolved, and the iron vitriol then formed partially reduces the dissolved silver, forming an insoluble basic salt. Dumas suggests that iron vessels were not attacked by sulphuric acid when dissolving granulated silver, as the inner surface of the vessels became coated with silver, thus preventing any contact of the iron and acid. According to Fechner,\* iron

\* SCHUBARTH, techn. Chem., ii., 383.



in concentrated sulphuric acid becomes electro-negative when in contact with silver or copper, so that these metals become dissolved, but not iron; it has therefore been proposed\* to commence the process in large cast-iron vessels and to finish it in small vessels of gold or platinum. The cast iron employed must be fine, granular, compact, and free from blisters; its solubility stands in inverse proportion to the carbon it contains. Iron containing phosphorus has given satisfactory results. Enamelled cast-iron vessels are sometimes used.

At the mint in Vienna two alloys are treated by this process.

One alloy contains a considerable amount of copper, and is formed into ingots of 9 or 10 lbs. weight. It is heated on the iron bottom of a reverberatory furnace, and granulated, thus oxidising the copper superficially. The mass is then sifted, and treated in quantities of 250 lbs. in a leaden pan, with sulphuric acid of 18° to 20°, previously heated to the boiling point, thus dissolving the copper. The residue is washed with water on a sieve, and heated and treated with sulphuric acid, until its silver is sufficiently concentrated. 600 lbs. of alloy can be heated in the reverberatory furnace in twenty-four hours, and the same quantity can be treated with sulphuric acid in seventy-two hours. 300 or 500 lbs. of the treated alloy are then heated in a cast-iron vessel 3 feet in diameter and furnished with a leaden lid, with double its weight of concentrated sulphuric acid, until dissolved. The escaping vapours are first conducted into a condensation chamber and thence into leaden chambers. The remaining very impure gold is melted with an addition of potash, about 3½ ozs. to 1 lb. of gold, and the resulting regulus submitted to the extraction process, together with alloys rich in gold.

250 or 300 lbs. of rich alloys are dissolved with two or two and a half times the quantity of sulphuric acid, in cast-iron vessels; this operation takes six or eight hours. 12 or 13 lbs. of dilute sulphuric acid of 52° B. are now added to assist the clarification of the solution, and after some time

\* ERDM., J. f. pr. Chem., ix., 49.

the silver vitriol is ladled out with an iron spoon. The remaining gold is first boiled in the solution vessel for two or three hours with sulphuric acid of 60°, then washed with cold water, and again boiled for two or three hours in a gold vessel with concentrated sulphuric acid, about five or six times the volume of the gold under treatment. Some cold water is next added and afterwards hot water, and the gold is washed in earthen dishes, being continually ground up; it is then heated and smelted in a plumbago crucible with an addition of two parts of borax and one part of saltpetre. If the gold contains lead, borax, saltpetre and corrosive sublimate are repeatedly added. The washing water is filtered and added to the precipitation pan.

The silver is precipitated from its solution, which has been diluted to from 15° to 25° B.; it is washed, dried, and melted in crucibles.

The solution of sulphate of copper resulting from the precipitation of silver, is boiled down for the production of vitriol, until at last the so-called black acid remains; this acid is concentrated and again used for dissolving silver.

The slags resulting from the gold melting are pounded, sifted, and washed, and then smelted with an addition of potash; the resulting regulus is again submitted to the extraction process. The slags from the silver melting are smelted with potash, and the dross and furnace ends are smelted with borax and saltpetre, yielding a regulus which is cupelled and treated by the extraction process. Silver containing 0.86 parts of gold in 1000 can still be profitably treated by this process.

At Frankfort\* and Kremnitz,† iron vessels are also used for extracting gold. At Poizat's establishment‡ in Paris, alloys poor in gold and rich in copper are treated in cast-iron vessels, and richer alloys in platinum vessels.

To granulate silver, it is melted in wrought iron crucibles capable of containing several cwts. The cast-iron vessels

\* Bgwkd., xii., 41. DINGL., Bd. 128, p. 359.

† ERDM., J. f. pr. Ch., ix., 73.

‡ KARMARSCH und HEERON, techn., Wörtorb., i., 942.

for extraction are furnished with iron lids, cast in two halves, one is permanently fixed to the vessel, and provided with a tube for conducting the sulphurous acid into a leaden chamber for the production of sulphuric acid.

Two parts of sulphuric acid are added to one part of silver, and heated until all the silver is converted into a pasty mass of sulphate of silver; this is then ladled into large leaden reservoirs, where it is dissolved in water and diluted to 36° B.; this liquid is heated to the boiling point by conducting steam into it, it is then diluted to 22° B., and allowed to settle. It is next separated from the gold by means of a syphon, precipitated, &c.

In Augsburg\* gold is extracted in cast-iron vessels, from auriferous coins. Cast-iron vessels are also employed in the mint at St. Petersburg.†

**Parting of Gold by means of Aqua Regia.**—This method is usually employed for treating gold poor in silver, from which silver can be only imperfectly extracted by sulphuric acid, and which cannot be treated advantageously by the quartation process, which requires a considerable quantity of silver to be present. The method is based on the fact that gold dissolves in aqua regia, as chloride, whilst chloride of silver is very slightly soluble in aqua regia.

The alloy is heated on a sand bath with three or four times its weight of aqua regia, composed of 1 part of nitric acid of sp. gr. 1.28, and 4 parts of muriatic acid of sp. gr. 1.178. The solution is removed, and the residue of chloride of silver boiled again with aqua regia, then washed with distilled water and reduced; the gold is precipitated from the solution. As the chloride of silver is liable to encrust the gold, the mixture must be either frequently stirred or a jet of steam introduced into it.‡

The following agents may be used for the precipitation of gold:—

\* Polyt. Centr., 1861., p. 1655. B. u. h. Ztg., 1862, p. 262.

† Oesterr. Ztschr., 1857, pp. 205.

‡ B. u. h. Ztg., 1852, p. 880.

**Iron Vitriol**,\*  $\text{FeO}, \text{SO}_3 + 7\text{HO}$ ; or **Chloride of Iron**,  $\text{FeCl} + 4\text{HO}$ .—The solutions of gold and iron vitriol are heated separately to  $70^\circ \text{C}$ ., and the iron vitriol is gradually poured into the solution of gold. When iron vitriol ceases to react upon the solution, the liquid is decanted and the gold, separated in compact lumps, is washed.

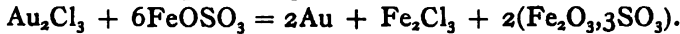

According to Rose† precipitated gold consists of very minute cubes; Morin‡ states that iron vitriol precipitates completely 0.0022 part of gold; but Elsner|| denies this. Levol§ considers this method of extraction to be imperfect, as chloride of silver remains dissolved together with the gold, even after boiling the solution, and the silver also is reduced by the iron salt.

This method, somewhat modified by Newton, is employed in the American mints.¶

**Oxalic Acid**,  $\text{HO}, \text{C}_2\text{O}_3$ .—According to Levol this agent precipitates very pure gold, but the process is tedious, especially if the acid is in excess; the liquid is liable to spirt away, owing to the development of carbonic acid, wherefore large vessels must be employed—

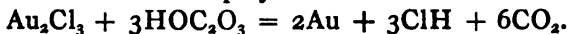

Jackson states that under certain circumstances gold may be obtained in a spongy form.

**Formic Acid**,  $\text{C}_2\text{H}_2\text{O}_3 + \text{HO}$ , and **Formiate of Potash**,  $\text{KO}, \text{C}_2\text{H}_2\text{O}_3$ , according to Morin,\*\* precipitate gold imperfectly.

**Chloride of Antimony**,  $\text{SbCl}_3$ , mixed with muriatic acid, according to Levol, reduces a somewhat warmed solution of gold after some hours. The gold is placed upon a filter, washed with considerably diluted muriatic acid, and melted in an earthen crucible, with an addition of borax and

\* Bgwkfd., xiii., 187.

† Pogg., lxxiii., 8.

‡ DINGL., Bd. 76, p. 38.

|| Ibid., 96, p. 490.

§ Ibid., Bd. 91, p. 232. Bgwkfd., vii, 460.

¶ B. u. h. Ztg., 1852, p. 880.

\*\* Dingl., Bd. 110., p. 375. Erdm., J. f. pr. Ch., xlix., 118. B. u. h. Ztg., 1849, p. 125.

saltpetre. 100 parts of gold require 200 parts of chloride of antimony.

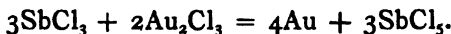

Chloride of Arsenic,  $\text{AsCl}_3$ , produced by dissolving arsenious acid in muriatic acid. According to Levol and Duflos, it quickly and perfectly reduces gold from neutral or faintly alkaline solutions.

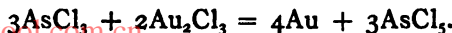

Chloride of silver may be reduced to the state of metallic silver\* by melting it with carbonate of potash, or better—according to Gay Lussac—with freshly-burned lime. Levol and Casaseca recommend a solution of caustic alkali and sugar, or melting with saltpetre and carbon. Hornung employs copper and ammonia; Zimmermann, iron, potash, and common salt; Wittstein heats the chloride of silver with moistened coal dust; Kessler uses acetate of iron; Bolley and Brunner the galvanic current; Böttger decomposes chloride of silver by heating it with a solution of crystallised soda, 1 part dissolved in 3 parts of water, whilst adding some grape sugar, about equal in quantity to the chloride of silver under treatment; Müller employs caustic soda and glycerin.

### III. SEPARATION OF GOLD FROM COPPER.

Alloys of gold and copper occur in mints, or they are produced in the form of auriferous and argentiferous black copper when working copper ores containing gold and silver. Gold cannot be perfectly separated from copper; for this purpose the following methods are chiefly employed:—

1. **Fusion with Lead.**—The alloy is either fused with lead and liquated, or it is added direct to the cupelling operation.

If one part of auriferous copper is combined and cupelled with 16 parts of lead, the copper oxidises and enters the litharge, whilst the gold combines with the lead, and finally with the brightened silver. Although very simple,

\* DINGL., Bd. 85, p. 77; Bd. 96, p. 175; Bd. 102, p. 320; Bd. 104, p. 42; Bd. 109, p. 373. BERZELIUS, Jahresber., 1845, p. 186. Polyt. Centr., 1849, p. 1196. Pogg., lxxxv., 462. Oesterr. Ztschr., 1855, p. 216; 1859, p. 68.

this method is only advisable when treating copper rich in gold, by adding it in small quantities (not above 6 per cent) to the cupelling operation of rich lead. Copper poor in gold cannot be treated advantageously by this method, as it causes considerable loss of lead and copper.

The liquation process also cannot be advantageously applied to copper poor in gold, as it not only causes great loss of copper and lead, but also of gold; copper almost always retaining a larger proportion of gold.

**2. Treatment with Sulphuric Acid.**—Of late this method has been frequently applied to argentiferous and auriferous copper, as its yield of metal is better. The copper is dissolved in either boiling concentrated sulphuric acid or hot dilute sulphuric acid.

Rich and pure alloys of gold, silver, and copper, are dissolved in concentrated acid, thus yielding gold and silver in a pure state, and copper as copper vitriol.

Impure black copper, containing little gold and silver, but more lead, antimony, and arsenic, is best treated with hot dilute acid, thus yielding copper vitriol, and leaving gold and silver along with the impurities in the residue, from which they are then extracted.

**3. Treatment with Chlorine according to Plattner's Method.**—At Mr. Vivian's works, near Swansea, this method is employed for extracting the small amount of gold contained in Russian copper coins. Upon re-melting the coins the gold concentrates in the lower part of the liquid metal; this part is then granulated, and the gold extracted from it by means of chlorine.

#### **Treatment of Auriferous and Argentiferous Black Copper by means of Boiling Concentrated Sulphuric Acid, as performed at Septèmes.\***

Silver produced in smelting works, foreign coins, ornaments, &c., if containing more than 0.6 per cent of gold, are treated direct with sulphuric acid. Substances poorer in gold are previously melted with copper, if there is great demand for copper vitriol, in order to produce greater

quantities of such vitriol as a by-product; otherwise the poorer substances are also dissolved direct in sulphuric acid.

a. Substances containing from 6 to 750 parts of gold in 1000 are melted for three hours in plumbago crucibles in quantities of 60 lbs., and granulated in a copper vessel. The granulated copper is then boiled in cast-iron pans in quantities of 30 or 34 lbs. with  $2\frac{1}{2}$  or 3 times its weight of sulphuric acid of  $50^{\circ}$  B. It is stirred with an iron rod, and the firing is interrupted when the distillation of sulphuric acid ceases; this takes place in about two hours. The distilled sulphuric acid of  $27^{\circ}$  B. is collected in a condenser, and is from time to time concentrated to  $50^{\circ}$  B. in a leaden pan. The sulphurous acid formed is conducted into a chimney. The pans used for dissolving last, on an average, three months; the platinum pans formerly employed were more expensive, required purer acid, and only admitted of lower charges.

The contents of the pans, consisting of silver and copper vitriol, and very finely divided gold, are cooled in a leaden pan to  $30^{\circ}$  C., and then transferred to vessels filled with boiling water, where they are stirred till completely dissolved. The firing is now interrupted, the stirring continued for a short time, and the liquid (being of  $17^{\circ}$  B.) is allowed to clarify. The gold, some silver vitriol, and sulphate of lead having deposited in about an hour, the clear liquid is drawn off by means of a syphon into a vessel containing plates of argentiferous copper, to precipitate all the silver; this will take about seven hours. The remaining lixivium of copper vitriol, of  $20^{\circ}$ , is again used for dissolving silver vitriol, and thus becomes concentrated to  $24^{\circ}$  B. The copper vitriol it contains is crystallised out, and the remaining acid lixivium again used for dissolving. The precipitated silver is washed with hot water and pressed into the form of bricks by a hydraulic press; these bricks still contain 8 or 10 per cent of water, and, when fused, have a fineness of 997.

When 8 or 10 lbs. of gold have collected in the clarifying vessel, they are removed, dried, and rich auriferous substances of a fineness above 750 being added, they are melted with silver from one to three times the weight of the gold, granulated and boiled in sulphuric acid of  $50^{\circ}$  B. The silver

is dissolved, and the fine gold left behind is washed, dried, and melted.

*b.* Substances containing less than six parts of gold in 1000 are fused with so much copper that 1000 parts of the alloy produced will contain 700 parts of auriferous silver, this being the best proportion for separating gold and silver, and also yielding less impure deposits of gold in the clarifying vessels. If a larger production of copper vitriol is required, an alloy containing 600 parts of auriferous silver is produced; the resulting gold deposits are then more impure and retain more silver. 60 lbs. of the alloy are melted in three hours and granulated. Charges of about 42 lbs. are dissolved in iron pans in sulphuric acid of 66° B. The resulting impure deposits of gold are melted with borax and saltpetre, yielding ingots, which are cupelled and again treated with sulphuric acid.

The poorer the substances under treatment, the impurer and the richer in silver are the resulting gold deposits, and the more expensive is the refining of these deposits.

Sometimes if the production of copper vitriol is not specially intended, the poor substances are treated direct with sulphuric acid of 55° B., and the gold deposits are either cupelled or treated again with acid when they have accumulated in sufficient quantity; the gold is then separated by the quartation method.



## CHAPTER XII.

### PLATINUM.

#### PRINCIPAL ORES OF PLATINUM.

PLATINUM is seldom found in its original geological formations, but is usually met with in alluvial ground and in the sand of rivers, usually in association with palladium, rhodium, osmium, ruthenium, iron, copper, lead, and sometimes also with silver; occasionally it occurs mixed with grains of osm-iridium, gold, magnetic and chrome iron ore, quartz, zircon, spinel, serpentine, &c.

Platinum, together with chrome iron ore, and its other associates, is supposed to have occurred primitively in serpentine,\* as fragments of serpentine and augitic rocks are frequently contained in platinum sand, and as native platinum and chrome iron ore sometimes occur disseminated in each other. The fragments of quartz occurring in platinum sand indicate the source of the associating gold, but this quantity of gold is but small, seldom exceeding 2 or 3 per cent. The present state of science shows that an alluvium containing magnetic iron sand will also contain gold, and that the alluvium contains platinum if a prevailing amount of fragments of serpentine occur in it.

Native platinum occurs only in the form of grains, which

\* ZERRENNER'S *Anleitung zum Gold, Platin- and Diamantwaschen*: Leipzig, 1851, p. xxi. MUSPRATT-STOHMANN'S *techn. Chem.*, 1860, iii., 950.

are usually flattened, and resemble in shape the gold nuggets. They are generally smaller than linseed, although in some cases they are as large as hempseed, or even peas. One piece brought from Choco in Peru, and presented to the Cabinet of Berlin by Humboldt, weighs  $882\frac{1}{2}$  grains, or more than 2 ozs. avoirdupois. There is also a lump of native platinum in the Royal Museum of Madrid, which was found in 1814 in the gold mine of Condoto, province of Novita, at Choco; it is larger than a turkey's egg (one diameter about 2 inches, and the other 4 inches), and its weight is 11,641 grains. In 1827 a specimen was found in the Ural mountains which weighed 11.57 pounds troy; the largest yet obtained being in the Demidoff Cabinet, weighing 21 lbs.

The following are the chief districts in which platinum occurs:—

1. At Choco, in the neighbourhood of Barbacoas, and generally on the coasts of the South Pacific, or on the western slopes of the Cordillera of the Andes, between the second and sixth degrees of north latitude. The gold washings furnishing most platinum are those of Condoto, in the province of Novita, those of Santa Rita or Viroviro, of Santa Lucia, of the ravine of Iro, and of Apoto, between Novita and Taddo. The deposit of gold and platinum grains is found in alluvial ground, at a depth of about 20 feet. The gold is separated from the platinum by hand sorting, and also by amalgamation.

2. Platinum grains are found in Brazil, but always in the alluvial soil containing gold, particularly those of Matto-Grosso, where the ore is somewhat different from the ore of Choco; it is in grains, which seem to be fragments of a spongy substance. The whole of the particles are nearly globular, exhibiting a surface formed of small spheroidal protuberances strongly cohering, and the interstices are clean and even brilliant. This platinum includes many small particles of gold, but none of the magnetic iron sand, or of the small zircons which accompany the Peruvian ore. It is mixed with small grains of native palladium, which may be recognised by their fibrous or radiated structure, and particularly by their chemical characters.

3. Platinum grains are found in Hayti, or St. Domingo, in the sand of the River Jacky, near the mountains of Sibao. Like those of Choco, they are in small brilliant grains, as if polished by friction. The sand containing them is quartzose and ferruginous. Like the platinum of Choco, this native platinum contains chromium, copper, osmium, iridium, rhodium, palladium, and probably titanium. Vauquelin found no gold amongst the grains.

4. Platinum is largely produced in the Russian territories, in the auriferous sands of Kuschwa, 250 wersts from Ekaterinebourg, and consequently in a geological position seemingly analogous to that of South America. It occurs chiefly at Nischnetagilsk and Goroblagodat in the Ural, in alluvial and drift material.

These auriferous sands are, indeed, almost all superficial; they cover an argillaceous soil; and include, together with gold and platinum, *débris* of dolerite (a kind of greenstone) protoxide of iron, grains of corundum, &c. The platinum grains are not so flat as those from Choco, but they are thicker; they are also less brilliant, and have more of a leaden hue. Langier's analysis showed this platinum to be similar in purity to that of Choco; but the leaden-grey grains, which were taken for a mixture of osmium and iridium, are merely an alloy of platinum containing 25 per cent of these metals. In Russia, platinum has been formed into coins of 11 and 22 roubles each, equal to about £1 15s. and £3 10s. respectively. And this country affords an amount of platinum nearly ten times larger than that produced in Brazil, Columbia, St. Domingo, and Borneo.

Platinum has been known in Europe since 1748, though it was discovered in 1736 by Anton Ulloa in the sand of the river Pinto in Choco. European chemists submitted it to minute investigations in 1750, and Chabaneau\* first formed it into bars. Platinum was discovered in Russia in 1822. But the first exact knowledge of the noble metals in alluvial ground was obtained by Alexander von Humboldt, Gustavus

\* B. u. h. Ztg., 1861, p. 335.

Rose, and Ehrenberg, on their expedition to the Ural and Altai mountains and to the Caspian Sea.\*

Platinum has been lately discovered in France,† and in the Alps.‡ Gueymard|| discovered platinum in the Alps of the Dauphiné and of Savoy in many minerals, rocks, and in the sand of rivers, also in the zinc, iron, and steel of other countries. Pettenkofer§ found platinum in nearly all the commercial silver produced by smelting processes, and also in gold. The gold in the sand of the Rhine¶ contains 0.041 per cent of platinum; the palladium extracted from gold at the Wilhelms-hütte,\*\* in the Hartz, also contains some platinum. The price of platinum, in proportion to the price of silver, is about as 5 to 1.††

Wollaston‡‡ first produced pure platinum, devoting twenty-five years to the investigation of this subject. His method of extracting platinum was not published until shortly before his death, in 1828.

Chabaneau||| is sometimes considered to be the first producer of pure platinum.

#### PROCESSES FOR THE EXTRACTION OF PLATINUM FROM ITS ORES.

The extraction of platinum was exclusively effected in the wet way until lately, when Deville published his dry process, which produces a more compact and durable metal in a simpler and cheaper manner.

Whichever way is employed, the raw platinum sand requires a previous dressing, usually consisting of washing the sand by more or less complicated machines;§§ afterwards

\* B. u. h. Ztg., 1842, p. 19. G. ROSE, Reisse n. d. Ural., 2 Bde., 1837 u. 1842. Bd. ii., p. 386.

† Ann. d. min., 4 ser., xvi., 505. Pogg., xxxi., 590.

‡ Ibid., 5 livr., de 1849, p. 495; 1 livr., de 1854, p. 165.

|| Ibid., 1 livr., de 1854, p. 165.

§ Bgwkd., xii., 38. ERDM., J. f. pr. Ch., xxxiv., 383.

¶ GMELIN, Ch., iii., 699 (1844).

\*\* Pogg., xxxiv., 380.

†† B. u. h. Ztg., 1842, p. 9.

‡‡ Pogg., xv., 299; xvi., 168. ERDM., J. f. ö.k. u. techn. Chem., vi., 221.

||| B. u. h. Ztg., 1861, p. 335.

§§ BERGGEIST, 1861, No. 26.

the gold is extracted by amalgamation, and the iron ore as far as possible by the magnet. Sand purified in this manner is sold under the name of raw platinum.

The composition of the raw platinum is shown by the following analyses\* :—

	I.	II.
Platinum . . . . .	78·94	57·75
Palladium . . . . .	0·28	0·25
Rhodium . . . . .	0·86	2·45
Iridium . . . . .	4·97	3·1
Osmium . . . . .	—	0·816
Iron . . . . .	11·04	6·79
Copper . . . . .	0·70	0·2
Osm-Iridium . . . . .	1·96	27·65

No. I. Non-magnetic grains from Nischnetagilsk on the Ural, by Berzelius.

No. II. Raw platinum from California, by Weil.

### The Extraction of Platinum in the Wet Way.

The whole of the platinum ore from the Ural is sent to the mint at St. Petersburg,† where it is treated by the following process.

The ore is first ground and sifted, and then put into open porcelain vessels capable of containing from 3 to 4 lbs. of ore, along with 15 or 20 lbs. of aqua regia, consisting of 3 parts of muriatic acid and 1 part of nitric acid. A number of these vessels are placed upon a sand bath covered by a glazed dome with movable panes, surmounted by a ventilating chimney to carry the vapours out of the laboratory. Heat is applied until, in eight or ten hours, no more vapours of nitrous acid appear. After settling, the supernatant liquid is decanted into large cylindrical glass vessels, the residuum is washed, and the washing is also decanted off. A fresh quantity of aqua regia is now poured upon the residue.

\* GMELIN., *Handb. d. Ch.*, iii., 700 (1844). LAMPAD., *Fortschr.*, 1839, p. 106.

† ERDM., *J. f. öx. u. techn. Chem.*, xiv., 319. POGG., xxxiii., 99; xl., 209. LAMPAD., *Fortschr.* 1839, pp. 1, 95, 108. URE's *Dictionary of Arts, &c.*, iii., 442.

This treatment is repeated until the whole solid matter has disappeared. For solution the ore requires from ten to fifteen times its weight of aqua regia, according to the size of its grains.

Solutions thus made are acid, which is essential to prevent the iridium from precipitating with the platinum by the solution of hydrochlorate of ammonia, which is next added. The yellow precipitate, which is a double salt—

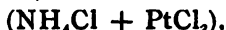

having been allowed to form, the mother liquor is poured off, the precipitate is washed with cold water, dried, and calcined in crucibles of platinum, thus yielding metallic platinum in a spongy form.

Cold water should be used to wash the precipitate, otherwise the resulting platinum will be contaminated, chiefly by iridium. Jacquelin\* recommends a mixture of 25 parts of chloride of potassium and 3 parts of chloride of ammonium for precipitating 100 parts of platinum, thus producing a more malleable platinum.

The mothers liquors and the washings are afterwards treated separately. The mother liquors are concentrated to one-twelfth of their bulk in glass retorts; on cooling they deposit the iridium in the state of an ammoniacal chloride, in a dark purple powder, occasionally crystallised in regular octahedrons. The washings are evaporated in porcelain vessels, and the residue is calcined and treated like fresh ore; but the platinum it affords needs a second purification.

To save aqua regia in the process, Descotil† and Hess‡ fuse the ores with eight or ten times their quantity of zinc; they then extract zinc from the pulverised and sifted alloy by means of sulphuric acid, and afterwards iron, copper, and lead by nitric acid, and finally they treat the residue with aqua regia.

Béchamp supposes that platinum dissolves in chloride of iron thus:—

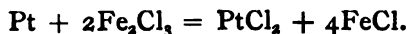

\* Bgwkfd., iii., 386.

† KARST., Arch., 1 R., iii., 92.

‡ ERDM., J. f. pr. Ch., Bd. 40, p. 498.

property of welding. Platinum commences to soften at a low red heat, but its welding only takes place at a white heat.

The first operation is to render the spongy platinum compact; according to Wollaston,\* this may be effected in the following manner:—The spongy platinum is ground and mixed with water to form a paste, and strongly pressed in a brass cylinder by means of a steel piston. The formed cake of platinum is heated, first moderately, and afterwards in a powerful wind furnace to as high a temperature as possible, and worked under heavy hammers whilst still red hot.

Platinum only melts at the very highest temperatures.†

Pettenkofer‡ has improved Wollaston's method; he first produces spongy platinum free from iridium by dissolving it in aqua regia, precipitating the platinum by means of muriate of ammonia, and gently heating the precipitate in a retort. He next boils the spongy mass with nitric acid and thoroughly washes it. The spongy mass is ground with water to form a fine paste, and pressed in quadrangular moulds by means of a hydraulic press or a projecting lever. The pressed platinum is then hammered on an anvil whilst repeatedly heated to whiteness, and a mixture of calcined borax and potash in equal parts is sprinkled upon the platinum plate and heated with it, thus removing any superficial impurity.

The welding and hammering of the platinum must be effected quickly, as platinum loses its heat much sooner than iron.

At St. Petersburg, the spongy mass is pounded in bronze mortars to agglomerate the platinum; the powder is passed through a fine sieve, and put into a cylinder of the size of the proposed ingot. The cylinder is fitted with a rammer, which is forced in by a coining press, till the powder is much condensed. It is then turned out of the mould, and baked thirty-six hours in a porcelain kiln, after which it may

\* POGG., xv., 299; xvi., 158.

† ERDM., J. f. pr. Ch., xvi., 512; xix., 180. B. u. h. Ztg., 1853, p. 537. KARST., Arch., 1 R., i., 6, p. 117; iii., 90.

‡ DINGL., Bd. 111, p. 371. Bgwkfd., xiii., 191.

be readily forged, if pure, and will take any form under the hammer.

Platinum utensils which have been used for some time become blistered, perforated, and useless; this may be owing to the platinum having been produced by Jeanetty's old method\* in the dry way, as it would then contain some arsenic which would become gaseous when heating the platinum vessels; sulphur, silicium, and particles of ash, &c., may act in the same manner. But, according to Pleischl,† perfectly pure platinum may behave in the same manner if it has been imperfectly forged, when some interstices filled with air remain in the platinum, and then gradually enlarge by re-heating. Pettenkofer and Erdmann‡ state that when repeatedly heated, platinum receives a grey coating from the disintegration of its surface, and that it gradually becomes brittle by a molecular change; this may be avoided by rubbing the platinum vessels with sea-sand every time after using them.

The residues of the process for extracting platinum contain chiefly palladium, iridium, osmium, rhodium, and ruthenium, which can only be separated by complicated operations.||

Alloys of platinum§ with iridium and rhodium have lately been produced, and are employed instead of pure platinum, as they are harder and better able to resist the reaction of acids, chiefly of aqua regia.

Osm-iridium¶ is employed for tipping the nibs of gold pens.

### The Extraction of Platinum in the Dry Way.

Deville and Debray\*\* produce platinum by the following methods.

\* DUMAS, *Angew. Chem.*, iv., 416.

† POGG., lxxiii., 113.

‡ B. u. h. *Ztg.*, 1861, p. 40.

|| POGG., Bd. 31, p. 161; Bd. 65, p. 200. ERDM., *J. f. pr. Ch.*, xxxiv., 173, 420; lxxx., 282. DINGL., Bd. 133, p. 270; 154, Hft. 4 and 5. Bd. 169, p. 278. B. u. h. *Ztg.*, 1862, p. 256. *Ann. d. Chem. u. Pharm.*, Bd. 120, p. 99.

§ B. u. h. *Ztg.*, 1860, pp. 20, 272; 1861, p. 407; 1862, p. 290. DINGL., Bd. 165, pp. 198, 205. *Polyt. Centr.*, 1858, pp. 1159, 1450.

¶ B. u. h. *Ztg.*, 1862, pp. 256, 290.

\*\* *Ibid.*, 1860, pp. 256, 272; 1861, p. 170; 1862, p. 76. *Ann. d. min.*, 5 sér. tom. 16; tom. 18, p. 11. DINGL., Bd. 154, pp. 130, 199, Hft. 4 and 5.



1. **Melting Platinum Ores.**—Platinum ores, mixed with 4 or 5 per cent of lime, are melted at a very high temperature in the furnace represented by Fig. 197. *a, a,* are

[www.libtool.com.cn](http://www.libtool.com.cn)

FIG. 197.

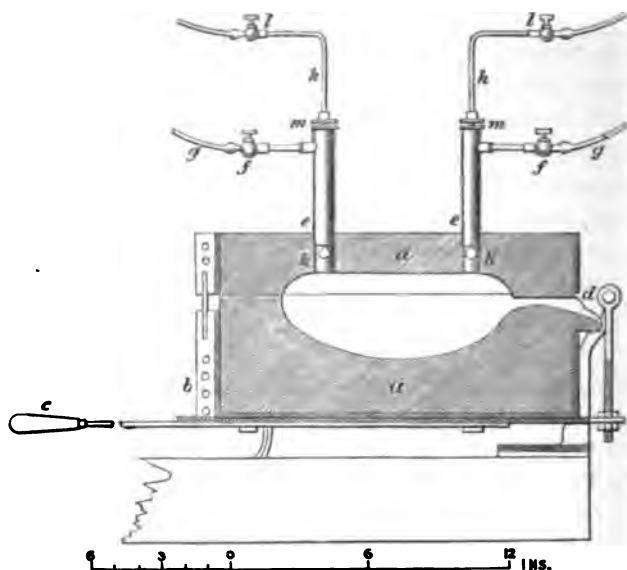

hollowed lumps of well burned lime placed one above another (bricks rich in silica are sometimes employed). The lime is placed in the casing, *b*, provided with the handle, *c*, for tilting over the case in order to pour out its contents. *d* is the opening for charging and emptying the apparatus; there is another opening for charging the apparatus on the roof of the furnace; this opening is kept closed by a plug of lime. *e, e,* are copper tubes joined at their lower parts on tubes of platinum, serving to admit hydrogen gas or carburetted hydrogen gas by the tubes, *g, g,* which are furnished with cocks, *f, f*; *h* are smaller tubes of copper fixed to the tubes, *e,* by the stuffing boxes, *m*, and provided at their mouths with platinum nozzles. They are also provided with the cocks, *l, l,* and serve to admit oxygen gas. These tubes, *h, h,* can be moved up and down in the stuffing boxes in order to regulate the combustion of the gases. Smaller furnaces have

sometimes only one tube for admitting oxygen. The section of the tube for admitting carburetted hydrogen gas must be about 1 square centimetre, and the tube for admitting oxygen must be about 2 or  $2\frac{1}{2}$  millimetres wide at the end where oxygen escapes. The oxygen is introduced under a pressure of 4 or 5 centimetres. It is cheapest when produced by conducting sulphuric acid through red-hot spongy platinum, thus decomposing the sulphuric acid into oxygen and sulphurous acid; the sulphurous acid is absorbed by water and caustic soda.

If oxygen and carburetted hydrogen are introduced in the proper proportion, the resulting flame burns without noise; if oxygen is in excess the flame whistles, and too much carburetted hydrogen causes a blowing of the flame.

The flame must touch the ore so as to melt it gradually, thus volatilising osmium, gold, palladium, and copper partially, whilst some copper, iron, silicium, &c., become oxidised, fused, and partly imbibed by the porous lime. The metal remaining is an alloy of platinum, iridium, and rhodium, from which platinum may be extracted by aqua regia. Upon tilting the furnace over by means of the handle, *c*, the fused platinum may be poured out through the opening, *d*, and made to run into moulds of sand, lime, gas-coke, or mould of cast-iron brushed with plumbago; but moulds of wrought iron coated inside with platinum plate are best. To avoid a spitting of the platinum an excess of carburetted hydrogen gas is admitted towards the end of the process; old platinum may also be re-melted in this way in charges of 50 lbs.\* An ingot of fused platinum,  $2\frac{1}{2}$  cwts. in weight, was shown by Messrs. Johnson and Matthey in the Exhibition at London, in 1862.

Fused and refined platinum is as soft as copper, and whiter and less porous than common platinum; it condenses gases on its surface, and possesses a specific gravity of 21.15. At a temperature near its melting point it crystallises in cubes and octahedrons, and, according to Debray, if kept for a longer time above its melting point, it volatilises; when melted for

\* B. u. h. Ztg., 1861, p. 170.

a longer time and rapidly cooled, it shows the phenomenon of spitting. Platinum does not fuse in a porcelain furnace, but, according to Aubel,\* it does in Racht's iron blast furnaces. Richter and Heräust doubt this, and explain it by the formation of more easily fusible combinations of platinum with either carbon or silicium. Heräus suggests that the spitting of platinum only takes place if oxygen is admitted under too great a pressure.

**2. Smelting of Platinum Ores with Galena.**—Equal parts of platinum ore and galena are fused in a reverberatory furnace, and continually stirred until a lead matt has been formed with the iron contained in the platinum ore, and till the platinum has alloyed with the separated lead. Some difficultly fusible glass is now added, the temperature raised, and litharge is gradually added to decompose the matt. When no more sulphurous acid is emitted, the metal bath is allowed to settle for some time, depositing osm-iridium; the plumbiferous slag is tapped off, and the plumbiferous platinum ladled out. The residue is reserved for the next smelting until it is sufficiently rich in osm-iridium. The plumbiferous platinum is then cupelled and refined in the lime furnace.

**3. Production of pure Platinum by combined Wet and Dry Processes.**—The ore is dissolved in aqua regia, the chlorides decomposed by heating, the reduced platinum separated from the undecomposed chlorides by washing, the platinum is boiled with nitric acid, and then refined in the lime furnace. The washed out substances are heated with sulphuric acid to extract iron, copper, and part of the palladium, and the remaining oxides of rhodium and iridium are washed, dried, and reduced in a crucible.

In 1862,† about 50 cwts. of raw platinum were produced in Russia.

\* B. u. h. Ztg., 1862, p. 392; 1863, p. 272.

† Ibid., 1863, pp. 195, 256.

‡ Ibid., 1862, p. 419; 1864, pp. 329, 341.

## CHAPTER XIII.

### SULPHUR.

#### PRINCIPAL SULPHUR ORES.

SULPHUR is produced from the following ores and substances :—

1. **Native Sulphur.**—Sulphur is found native in three different forms—1st, in kidney-shaped lumps, disseminated through layers of tertiary or contemporaneous formations; 2nd, in irregular masses in chalky formations, associated with gypsum and rock salt; it is principally found in this condition in the mines of Sicily, which supply nearly all the commercial sulphur in Europe; 3rd, as a sublimate round the mouths of volcanoes, where it is mixed with the ashes or sand; the solfataras of Guadaloupe and Pouzzales supply it in this state.

The principal sulphur mines of Sicily are situated near Cattolica, Girgenti, Licata, Caltanissetta, Caltascibetta, Centorbi, and Sommatino.

Sulphur in admixture with different minerals is called sulphurous earth.

2. **Metallic Sulphides**, chiefly iron pyrites,  $\text{FeS}_2$ , containing 53·33 per cent of sulphur; and copper pyrites,  $\text{Cu}_2\text{S}$ ,  $\text{Fe}_2\text{S}_3$ , containing 34·89 per cent of sulphur.

3. **Artificial Products**, such as the residues of the manufacture of soda, which contain oxysulphide of calcium, and allow of the extraction of the sulphur in an indirect way.

**SYNOPSIS OF PROCESSES FOR THE EXTRACTION OF  
SULPHUR FROM ITS ORES.**

[www.libtool.com.cn](http://www.libtool.com.cn)

According to the richness of the ores, these processes are based either upon a liquation process, when the ores are very rich, or upon a heating of the ores, and expelling the sulphur in the form of a vapour, which is collected and condensed (distilling process). The sulphur produced by the liquation process contains more mechanical admixtures than the distilled sulphur. Sulphur forms a thin fluid at 112° C., and solidifies at 108° or 109° C.; it is a thick fluid of a darker colour at 140° C, and it forms a pasty mass scarcely fusible at 220° C. When heated up to 340° its mobility decreases, and its volatilisation commences at from 420° to 440°, when it is almost black.

The apparatus used for the distillation of the sulphur varies in different establishments. Closed vessels (tubes of iron or clay) are sometimes used, which must be heated by a separate firing. Open heaps or cupola furnaces are made use of in other works, and then the temperature required for distillation is produced by burning part of the sulphur.

The choice between the different methods chiefly depends on the prices of fuel, sulphur, and labour.

As the expulsion of the last portions of sulphur from pyrites necessitates a higher temperature than is required at the commencement of the process, and as the higher temperature attacks the distilling vessels more strongly, a large yield is always abandoned in order to save fuel. Iron pyrites may yield 23 per cent of sulphur when heated so as to form magnetic pyrites—



but the smelting works do not usually produce more than 15 or 18 per cent. Copper pyrites,  $\text{Cu}_2\text{S}, \text{Fe}_2\text{S}_3$ , yields 9 per cent of sulphur, being ultimately transformed into  $\text{Cu}_2\text{S}, 2\text{FeS}$ .

The raw sulphur obtained by the liquation or distillation process contains mechanical admixtures of ore, and sometimes arsenic and selenium in chemical combination.

According to Phipson,\* sulphur from the Solfatara, Naples, contained 87·6 per cent of sulphur, 11·162 per cent of arsenic, and 0·264 per cent of selenium.

Only the mechanical admixtures are separated by refining the sulphur, either by a re-melting or a subliming. The sulphur produced from pyrites is still more impure than that extracted from sulphurous earths. It is said that the common English brimstone, such as was extracted from the copper pyrites of the Parys mine in Anglesea, contained fully a fifteenth of residue, chiefly orpiment, insoluble in boiling oil of turpentine. The residues of the extraction of sulphur from sulphurous earths are thrown away; those from iron pyrites are used for the production of sulphate of iron and alum; and if they contain valuable metals, such as copper, silver, or lead, the residues are submitted to suitable processes for extracting these metals.

For extracting sulphur from the residues of the soda manufacture, different methods have been recommended, some of which have been brought to great perfection. Gossage, Favre, and Noble treat the residues with the muriatic acid resulting as by-product from the soda manufacture, producing sulphuretted hydrogen gas, which is then decomposed by sulphurous acid, forming sulphur and pentathionic acid:—

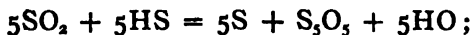

this entails a great loss of sulphur.

Three different methods have been patented in England, as follows:—L. Mond, 8th September, 1863; M. Schaffner, 23rd September, 1865; P. W. Hofmann, 9th April, 1866. These processes are all based on the same principle, viz., the conversion of the insoluble sulphide of calcium in the waste into soluble compounds by bringing the waste into contact with air in order to oxidise it; the lixiviation of the oxidised mass; and the precipitation of the sulphur in these liquors by a strong acid,—in practice muriatic acid. Though it is only within the last few years that sulphur has for the first time been regularly manufactured from alkali waste by Mr. Mond's process, the progress of

\* ERDM., J. f. pr. Ch., Bd. 88, p. 497.

this new industry has advanced so rapidly that, at the Paris Exhibition of 1867, no less than seven works exhibited sulphur recovered from waste by the methods patented in England.

Mr. Ludwig Mond\* describes this important process as follows :—

“ Alkali waste, black ash waste, tank, vat, or blue waste, are the different names of the insoluble residue obtained by the lixiviation of artificial crude soda, or black ash, produced by Leblanc’s celebrated process for the manufacture of alkali. Every ton of alkali produces no less than  $1\frac{1}{2}$  tons of dry waste, and this waste has been always regarded as the greatest drawback to this important manufacture. The enormous quantities of waste thus obtained are generally deposited in the neighbourhood of the works, often forming hills of considerable height. In damp weather especially this waste evolves large quantities of sulphuretted hydrogen, that most noxious and most disagreeable of all gases, greatly annoying the surrounding population ; and, moreover, the rain and ground-water coming into contact with it dissolve out considerable quantities of yellow liquor, containing hydrosulphide and polysulphide of calcium, which poisons the water of all wells and rivers to which it has access. These evil results are altogether due to the sulphur contained in the waste, which amounts to no less than 80 per cent of all the sulphur used in the manufacture of alkali, and which represents, of course, a very considerable value.

“ In 1852, W. S. Losh took out a patent for obtaining hyposulphite of soda by exposing waste in heaps to the atmosphere, lixiviating it, adding carbonate of soda to the liquor, and crystallising.”

Mr. Mond now makes the further statements :—

“ Being engaged in researches on the different processes for sulphur recovery by Mr. Gossage and others, in the summer of 1860, my attention was drawn to Mr. Losh’s patent, and I at once started a series of experiments in order to ascertain whether, and under what conditions, a quantity of hyposulphite of lime could be obtained by oxidation

+ Chemical News, 1867, No. 398, 399.

of the waste, which would render practicable the extraction of sulphur on a large scale, and its recovery by means of muriatic acid. I soon found out that the formation of soluble sulphur compounds in the waste increased only up to a certain maximum, when sulphur to the extent of about 5 per cent of the weight of the dry waste could be extracted by lixiviation, and that this quantity decreased by exposing the waste any longer. When these soluble compounds, however, were washed out, the waste oxidised quite as well a second time, a similar quantity of sulphur being obtained again; and this treatment could be advantageously repeated even a third time.

“ The waste I used for these experiments being lixiviated by a singular method, since abandoned, was, however, so dense that all efforts to oxidise it in heaps or by forcing air through it failed, so that I had to expose it in shallow layers on shelves. This process was patented in France in December, 1861, and in England in August, 1862, and sulphur to the extent of 12 per cent of the waste has been obtained by it in considerable quantities in a German alkali works.

“ Coming to England in the autumn of 1863, I very soon found, however, that the enormous quantities of waste to be treated, and the high rate of wages, made this process quite impracticable here, and that the waste produced by the excellent process of lixiviating black ash in general use in this country was very likely to allow of a much more simple treatment. I tried again to oxidise it by forcing air through it, and succeeded so well that the time necessary to oxidise and lixivate the waste, which had previously been six to eight weeks, was soon reduced to 60 or 80 hours, and that manual labour was almost altogether avoided by performing these operations in the same vat in which the waste was produced, without moving the latter. These facts led to a new process, which was patented the 8th of September, 1863, since when there have been no alterations in the main features of the process.

“ In place of the set of four vats, generally in use for lixivi-



ating black ash, I employ a set of ten or twelve. All these are connected by pipes in the usual way, so that the soda liquor runs from the bottom of one vat to the top of the next one, and by special pipes and taps, which allow the sulphur liquor to run out of the bottom of each vat to the top of any other vat in the set. Besides this, they are provided with extra taps and shoots to convey the sulphur liquor to wells or settlers. The lower parts of all the vats are connected with a fan, capable of producing a pressure of about 7 inches of water by pipes, with dampers, which regulate the quantity of air passing through. A silent fan of Schiele's construction, 20 inches in diameter, price £10, propels a sufficient quantity of air for the treatment of the waste, resulting from 100 tons of salt-cake per week. Four of these vats are always filled with black ash in the course of lixiviation, the other six or eight with waste to be treated according to my invention. As soon as the black ash is completely spent and the weak liquor well drained off, the connection with the fan is opened. The waste soon begins to heat, (the temperature gradually rising above 200° F.), gives off quantities of steam, becoming greenish and afterwards yellow on the top, gets more and more dry, and would take fire if the air was passed through long enough. The period at which oxidation should be stopped, and the passing of air discontinued, so as to give the best results, must be ascertained in each works by experiment, and varies according as much or little hyposulphite in the liquors is desirable. In the beginning of the action, hydrosulphide and bisulphide of calcium are formed, which are afterwards oxidised into hyposulphite. A part of the hyposulphite is again decomposed into sulphur and sulphite, which is very insoluble, and cannot be extracted by lixiviation. Carrying the oxidation too far would therefore entail a serious loss. On an average, the time of exposure will be limited to between 12 and 24 hours. The waste is now lixiviated systematically with cold water, the weaker liquors passing from one vat to the next one in course of lixiviation, so as to obtain only strong liquors, which operation can be easily performed in 6 to 8 hours. When this lixiviation is finished, air is again passed through the waste

in exactly the same way as before, the waste is again lixiviated, and the same treatment repeated a third time. The vat is then ready to be cast, and is again filled with black ash. When the operations have been conducted well, sulphur equal to about 12 per cent of the weight of the salt-cakes used in making black ash, is obtained in solution from the waste. The waste contains only traces of sulphide of calcium, and is principally composed of carbonate of lime, sulphite and sulphate of lime, which, far from being noxious, make the waste, on the contrary, a valuable manure. In separating the sulphur from the liquors thus obtained, by adding muriatic acid, I met with much more difficulty than I had anticipated from apparently so simple a reaction.

“ Firstly, I wanted an easy and rapid method of determining the quantity of acid necessary for the decomposition of a given quantity of liquor, which always contains hyposulphite, polysulphite, and hydrosulphide of calcium and sodium. For this end I availed myself of the following method :—

“ 1. The hyposulphite is determined as usual by a standard solution of iodine and starch, after having first separated the polysulphide and hydrosulphite by adding an excess of chloride of zinc, and filtering.

“ 2. To a certain quantity, say 3·2 c.c. of the original liquor, and starch, is added a standard solution of iodine until it turns blue; the liquor is then again decolourised by a drop of hyposulphide of soda solution, and litmus and a standard solution of caustic soda are added until the liquid is neutral.

“ The following reactions take place :—

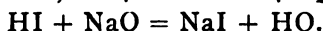
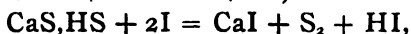
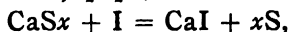
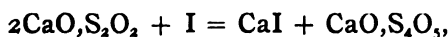

Thus the caustic soda corresponds to the sulphuretted hydrogen, the iodine used in the first titration to the hyposulphite, and from the iodine used in the second titration and

the two former numbers the calcium present in the form of sulphide is easily calculated.

“ Using for both titrations 3·2 c.c. of liquor, and standard solutions containing one-tenth of an equivalent per litre, and presuming that the polysulphide is bisulphide only, we have simply to add the measures of iodine used in both determinations, to subtract the measures of caustic soda, and divide this number by ten, in order to find the total percentage of sulphur in the liquor, from which the muriatic acid is easily calculated, every 32 of sulphur requiring 36·5 of hydrochloric acid.

“ Generally the polysulphide contains very little more than two equivalents of S to one of Ca, so that this method is also sufficiently exact for the determination of the sulphur in the liquors, for practical purposes.

“ Though this method has been proved to be perfectly correct by a number of accurate experiments, the muriatic acid, as calculated by it, was still more than was actually required to effect a complete decomposition of the liquor. A number of careful investigations made with the view of explaining this fact have shown that, contrary to the assertions of all chemical handbooks, the products of the decomposition of hyposulphite of lime by muriatic acid are comparatively little sulphur and very little sulphurous acid, but principally trithionic acid, and a small quantity of pentathionic acid. The reaction was proved to take place principally according to the following equation—

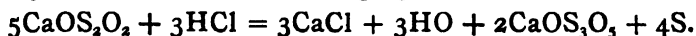

“ On boiling, the trithionate of lime is decomposed to sulphate of lime, sulphur, and sulphurous acid. The latter transforms a portion of the hyposulphite, which is still in the liquor, again into trithionate, according to the well-known equation—

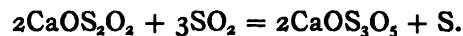

The newly-formed trithionate is again decomposed, and so on. In consequence of these reactions it is possible to decompose a solution of hyposulphite of lime completely into sulphur, sulphate of lime, and very little sulphurous acid by

adding to it when boiling a quantity of muriatic acid sufficient to neutralise about one-half of the lime in solution.

“ In places where hydrochloric acid has a comparatively high value these facts may be taken advantage of. As, however, at the present moment, fully one-half of the acid produced by the decomposition of salt is run into the rivers or passes into the air, and as, besides, the above-quoted reactions involve a very heavy loss of sulphur in the form of sulphate of lime, and produce also a very impure sulphur, I prefer the following plan, which avoids these inconveniences :—

“ The oxidation of the waste is regulated so as to obtain a liquor which contains as nearly as possible to every equivalent of hyposulphite two equivalents of sulphide. This liquor is decomposed by first adding to a certain small quantity of acid an excess of liquor until there is a trace of sulphide in the mixture ; then a quantity of acid sufficient to neutralise the whole of the calcium is poured in, a new quantity of liquor equivalent to this last quantity of acid is added, and then acid again, and liquor again, and so on, until the vessel is nearly filled. To the last liquor only one-half of the required acid is added, and steam introduced, until the liquid shows a temperature of about 140° F. Practically speaking, the liquor and the acid are poured at the same time into the decomposing vessel in nearly equivalent proportions, the workmen taking care to keep a small excess of liquor up to the end of the operation. This part of the process is carried on in wooden tanks covered in and connected to a chimney, in order to carry off any sulphuretted hydrogen which may be evolved by mistake of the workman. If properly carried out there should be, however, no appreciable quantity of that gas evolved.

“ The practical result of this mode of working is simply precipitation of nearly the whole of the sulphur in a pure state :—

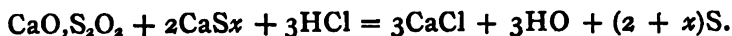

The details of the reaction are, however, very complicated, almost all the different acids of sulphur being probably formed during the process.

“ In the first place, by adding liquor to acid, some sulphuretted hydrogen is given off (which may be avoided by starting the operation with liquor rich in hyposulphite) and hyposulphurous acid is set free, which will give rise to the formation of sulphurous and several thionic acids. All these are, however, again converted into hyposulphite by the sulphide of calcium in the liquor, then added in excess .—

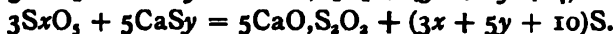
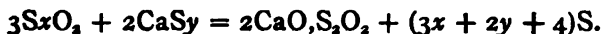

The muriatic acid entering next thus only produces hyposulphurous acid, and its products of decomposition, which are again converted into sulphur and hyposulphite without the formation of any gaseous product, and so on. At the end there is a certain quantity of hyposulphite left in the liquors, which is decomposed into sulphate and sulphur by adding an insufficient amount of muriatic acid. In practice about 90 per cent of the muriatic acid, calculated according to the above-described method, are required to effect thus the complete decomposition of a well-proportioned liquor. If it contains more hyposulphite than above indicated, less acid is of course to be used. About 90 per cent of the sulphur contained in the liquor is precipitated in an almost pure state, and settles exceedingly well within two hours. The supernatant clear solution of chloride of calcium is then drawn off and another operation directly commenced in the same vessel. As soon as a sufficient quantity of sulphur is collected in it, which will depend on the size of the vessel and on the strength of the liquor (varying from 4 per cent to 7 per cent of sulphur), it is drawn out by means of a door at the lower part of the vessel into a wooden tank with a double floor, where the chloride of calcium is washed out by water, and the sulphur then simply melted down in an iron pot. The product thus obtained contains only from one-tenth per cent to 1 per cent of impurities, and is thus by far superior to any sort of brimstone in the market, though it has sometimes a rather darker colour, caused by traces of sulphide of iron, or a little coal dust, which latter may have been suspended in the muriatic acid.

“ The total yield of sulphur obtained by the process amounts thus to 10 or 11 per cent of the weight of the salt-cake used in making black ash, or to about one-half of the sulphur therein contained, and to about 60 per cent of the sulphate contained in the waste. I still hope, however, to be able to increase this quantity considerably by some more years' experience. The cost of production, as well as that of the plant, are inconsiderable. In the different continental and English works, where the process has now been working for years, the expense for wages, fuel, and maintenance amounts only to £1 per ton of sulphur, and the outlay for the plant has been more than covered by the net profits of the first year.

“ The two other processes represented at the Paris Exhibition are, as stated, based on the same principle.

“ M. Schaffner oxidises the waste in heaps, exposing it for several weeks, lixiviates, and repeats this treatment three times. He decomposes his liquor by adding muriatic acid, after having heated it to the boiling point, conducting the sulphurous acid formed into a vessel filled with fresh liquor, and thus producing sulphur mixed with large quantities of sulphate of lime, as above stated. This impure sulphur he refines in a very ingenious way by melting it under water in a closed vessel provided with an agitator, thus obtaining a product of remarkably fine colour and great purity. This process has been adopted in a number of German works.

“ M. P. W. Hofmann oxidises the waste by spreading it on a large surface and moistening it with a solution of chloride of manganese in order to facilitate the oxidation, which, however, requires some weeks before it is completed. He then lixiviates, and in order to separate sulphur from the liquors so obtained he avails himself of the muriatic acid contained in the waste liquor of bleaching powder stills, as has already been proposed by Messrs. Townsend and Walker in 1860. He mixes these liquors in such proportions as just to saturate the free acid, and thus obtains a product containing about 92 per cent of sulphur.”

Hofmann's process is in operation at the alkali works at

Dieuze, near Nancy, in France, and is described by Mr. I. Lothian Bell,\* as follows:—

“In the manufacture of soda the use of sulphur plays an important part; the office it performs being to effect, in the form of sulphuric acid, the decomposition of common salt.

“The sulphate of soda obtained from this action in its turn is subjected to decomposition by exposure to heat along with carbonate of lime and coal, a process which transfers, practically, almost the whole of the sulphur to the lime, or to the metallic base of this earth, the only exception being the small portion which remains with the soda as an impurity.

“This new combination of sulphur is separated from the soda salts by lixiviation, and the portions undissolved, containing the sulphides of lime and calcium, and known as soda-waste, are thrown away.

“I will not dwell on the inconvenience the soda-maker is exposed to from having to provide deposit-room for such a large quantity of refuse as the mode of treatment just mentioned gives rise to, nor on the somewhat offensive nature of the soda-waste itself, rendering the alkali manufacturer's heap anything but a desirable neighbour.

“Various are the plans which have been suggested for the recovery of this, the most costly element of the soda-maker's process, but hitherto, so far as actual practice is concerned, the whole of the sulphur employed by them may be said to be still thrown aside after it has once done the duty just alluded to.

“Having heard a favourable account of a method in operation, at the Chemical works of the Dieuze Company, near Nancy, by the permission of the proprietors, I visited that establishment in the month of July last, and it is a brief account of their process that I give in the following communication.

“It will be convenient at this stage of the description to mention that in most soda-works there exists another residual product scarcely less embarrassing in its nature than that previously mentioned. The muriatic acid obtained

\* Chemical News, 1867, No. 408.

from decomposition of common salt with sulphuric acid, along with peroxide of manganese, is employed very extensively in the manufacture of bleaching powder, a process which gives rise to the generation of a large quantity of liquid chloride of manganese mixed with chloride of iron and free hydrochloric acid. The whole of these solutions are run away into the nearest water-course in the vicinity of the different manufactories.

“The process I am about to describe requires the assistance of this second equally valueless material. The operation is as follows:—The soda-waste, after being removed from the vessels in which it has been separated from the soda, is thrown into a tank of stone-work about twenty yards long, by five in width, and six feet deep. In this vessel an intimate mixture is easily effected of the soda-waste and the metallic chlorides of the refuse from the bleaching powder process, and from which later all the free muriatic acid has been removed in a manner to be hereafter described. Were the free acid still present, a loss of sulphur by the generation of sulphuretted hydrogen would take place, and this on all accounts it is obviously best to avoid.

“A few hours suffice to convert the chlorides of manganese and of iron into sulphides, when the soluble chloride of calcium generated by the action is allowed to drain off. The solid matter remaining is cast out into a heap by the side of the tank containing it. In two or three days the heap is turned over, and in a short time a considerable elevation of temperature ensues, indicative of strong chemical action. To restrain this somewhat, the mass is kept moist, otherwise spontaneous combustion would ensue, sulphur would be wasted, and the desired results generally interfered with. During this stage of the process the metallic sulphides, under the joint action of the atmosphere and moisture, are peroxidised, and sulphur is separated. The oxides of manganese and iron so obtained are by subsequent turning over brought into contact with other portions of sulphide of calcium of the soda-waste, and are again converted into their respective sulphides, which give up their sulphur a second time in the way already described. The process is



continued so long as there remains any sulphide of calcium from which it is sought to separate sulphur in the manner explained. The sulphur thus liberated is taken up by another portion of the sulphide of calcium of the soda-waste, and a polysulphide of calcium results from the combination, which is soluble in water. The formation of polysulphide continues as long as other portions of the original sulphide of calcium go on yielding up their sulphur to generate the sulphides of manganese and iron.\* In this way almost the whole of the sulphide of calcium originally contained in the soda-waste is converted into polysulphide of calcium, hyposulphite, and oxysulphide of lime, all of which are easily dissolved in water. Something like four or five days are required to effect these changes. These soluble salts are separated from the insoluble portions of the mass exactly in the same way as the ball alkali is treated for obtaining the soda it contains. Vats resembling in construction those of the soda works, and of a capacity equal to the daily production of soda-waste, are placed near the locality in which the preceding stage of the process has been effected, and in a very speedy manner the polysulphide and other salts are run off as a deep orange yellow solution, hereafter denominated the yellow liquor.

“The composition of the insoluble portion is as follows:—

CaO, SO <sub>3</sub> . . . . .	66·248
CaO, CO <sub>2</sub> . . . . .	1·320
CaO . . . . .	20·982
Fe <sub>2</sub> O <sub>3</sub> and Al <sub>2</sub> O <sub>3</sub> . . . . .	7·000
MnO . . . . .	1·500
Insoluble . . . . .	2·800
	<hr/>
	99·850

“As a refuse this substance will be recognised as being of an inoffensive character to the neighbourhood, so far as any subsequent chemical action is concerned. Unlike the original soda-waste, it contains no ingredient liable to

\* Along with this formation of polysulphide of calcium there goes on at the same time a generation of hyposulphite and oxysulphides of lime, due to the liberation of oxygen from the metallic oxides at the moment of being again converted in sulphides.

oxidation; it cannot therefore give off any of those unpleasant compounds which more or less are found in the vicinity of all alkali works. It is, moreover, not unreasonable to expect that a matter consisting chiefly of  $\text{CaO}$ ,  $\text{SO}_2$ , and  $\text{CaO}$  may be found useful as a stimulant to various descriptions of soils, and thus the whole of the S used in the soda process in one shape or another may be rendered useful, instead of being a nuisance, as is the case at present.

“ The residual products from the bleaching powder works are received into a tank so built that free hydrochloric acid does not destroy the structure. By this means any insoluble portions are separated, and the clear liquid is run off into an adjoining cistern.

“ To this acid solution of chloride of manganese and iron is added that of the polysulphide of calcium and the lime compounds of sulphur obtained in the manner previously given. The presence of free hydrochloric acid causes an immediate precipitation of all the sulphur, free from the sulphide of calcium and the accompanying substances containing sulphur; and the addition of the yellow liquor is continued until the first appearance of a black colour, indicative of all the free acid being neutralised, and the first portion of iron from the chlorine residuum commencing to be precipitated. The precipitated sulphur is removed from the liquid, and the greater portion of the accompanying water is separated by pressure. After this the remainder of the moisture is expelled by a very low heat, and the sulphur is then employed for producing sulphuric acid.

“ It is obvious from what has preceded that the chlorides of manganese and iron must be left in the solution from which the free hydrochloric acid has just been removed in precipitating the sulphur; and it is in this way that the neutral solutions of these metals are obtained which are required for operating upon subsequent portions of the soda-waste.

“ This process has been in operation at Dieuze for some months, and at the present moment by its means about  $1\frac{1}{2}$  tons of sulphur are being recovered daily. It will be seen that no new material is required, the only ingredients being

apparatus employed is of a most simple character, consisting almost entirely of tanks, on which the expense for maintenance will be a mere trifle—in fact, the whole cost is one of labour, which at the Dieuze works amounts to something like 40s. per ton on the sulphur obtained.

“Supposing 40 per cent of the sulphur used in this kingdom to be thus recovered, the annual saving this process is capable of effecting will amount to a considerable sum.

“Instead of employing the ‘yellow liquor’ and the chloride of manganese in the way set forth in this paper, an attempt has been made at Dieuze to employ both as a means of recovering manganese, a desideratum with bleaching-powder makers as eagerly sought for as the regeneration of sulphur has been with the soda manufacturer. I shall with your permission proceed to describe the process which the owners of the establishment assured me promises to be a success.

“The acid solutions from the bleaching-powder works, being all required in order to precipitate sulphur by means of the free hydrochloric acid, contain a considerable quantity of neutral chlorides of manganese, and will remain on hand. To such portions of these neutral chlorides as are not used in the sulphur process itself, yellow liquor is added in a suitable tank so long as a black precipitate falls, which is variable in quantity with the varying composition of the manganese used. The black precipitate consists of sulphide of iron and free sulphur, which can be collected and burnt in an ordinary furnace for burning pyrites.

“The iron being thus all separated from the metallic solution, a fresh quantity of yellow liquor is added, by which all the manganese is thrown down, the precipitate consisting of some free sulphur and sulphide of manganese.

“The sulphide of manganese is burnt in the same way as that of iron, but the residue, instead of being all oxide, as is the case when the sulphide of iron is under treatment, is composed of protoxide and binoxide of the metal mixed with a certain quantity of sulphate of manganese. The oxides are separated in the usual way by water, and being almost

chemically pure, are of great value to the glass-makers, to whom the presence of the iron usually found associated with commercial manganese is a subject of great inconvenience. [www.libtool.com.cn](http://www.libtool.com.cn)

“The sulphate of manganese, in a concentrated solution, is added to nitrate of soda in quantities denoted by the equivalents. When heated, decomposition takes place; nitrous acid is given off, which may be used in the sulphuric acid chambers, or otherwise disposed of; and the residue consists of sulphate of soda and the protoxide and binoxide of manganese, which latter represent, so far as available oxygen is concerned, a manganese amounting to 65 to 70 per cent of binoxide. The oxides of manganese are separated from the sulphate of soda in the usual way by washing with water, and both used for any purpose to which these two substances are commonly applied.

“I may add that these operations have been carefully examined by some of the leading men of science in France, both in their practical and scientific relations, and that in the recent adjudication of prizes at the International Exhibition, at Paris, the inventors had a gold medal awarded for the service they are considered to have rendered to the industry of their country.”

Spencer\* produces sulphuretted hydrogen from the residues of the soda manufacture and from lime which has been used for purifying coal gas. This sulphuretted hydrogen gas is made to react upon per- and protoxide of iron, forming sulphide of iron, which is then submitted to a distillation or roasting process.

Great quantities of froth-like sulphur are separated from the mother liquor obtained in the production of iodine in Scotland,† owing to the decomposition of polysulphides and hyposulphites.

Though these processes, strictly speaking, are not metallurgical operations, we have not hesitated to give the most important of them *in extenso*, as their further development

\* Polyt. Centr., 1860, p. 555.

† WAGNER'S Jahresber., 1859, p. 168.

will influence the price of sulphur, and thus indirectly bear upon the extraction of sulphur from its ores.

[www.libtool.com.cn](http://www.libtool.com.cn)  
The chief methods of extracting sulphur from its ores may be classified under the two following divisions.—

### I. EXTRACTION OF SULPHUR FROM SULPHUROUS EARTHS.

Very rich earths are melted in pans. In Sicily, Milos, and Spain these ores are liquated in small cupola furnaces after the old Sicilian method. An improved method is now also employed in Sicily, namely, a liquation in mounds. At Radoboi and Swoszowice, the sulphurous earths are distilled in furnaces.

### II. EXTRACTION OF SULPHUR FROM IRON PYRITES OR PYRITIC ORES.

At Altsattel and Rosenau these ores are distilled in vessels; they are roasted in cupola furnaces at Johann-Georgenstadt, Breitenbrunn, and Sembirsk; roasted in mounds at Bohemia, Saxony, Salzburg, Steyermark, and Agordo; and roasted in open heaps at the Lower Hartz and Agordo.

The raw sulphur resulting from either of those methods is then submitted to purification either by re-melting, distilling or subliming.

#### 1. Extraction of Sulphur from Sulphurous Earths.

The following methods of extraction are used according to the richness of the ores and the prices of fuel and sulphur.

1. **Smelting very Rich Ores in Pans.**—The richest pulverulent Sicilian sulphurous earths are melted in cast-iron pans with a capacity of about 2 cubic metres. The ores are gradually charged whilst stirring till the pans are filled, when the gangue is removed from the liquid mass. The temperature must be kept a few degrees above the fusion-point of the sulphur so as to render the sulphur as liquid as water without igniting it, and to allow a perfect separation of the earthy substances at the bottom of the pan and on the surface of the fused mass. Having allowed the whole to settle, the froth formed on the surface is skimmed off, and the clarified sulphur ladled into iron boxes, allowing the deposit

at the bottom of the pan to remain till after several meltings. The cold sulphur is broken into pieces and sold as raw sulphur. The melting of one charge in pans with a capacity of 2 cubic metres takes from 6 to 8 hours, the clarification of the mass 12 hours, and the ladling out 2 hours, consuming an amount of wood equal in weight to 10 per cent of the ore treated. The removed gangue retains about 30 per cent of sulphur, and the deposits on the bottom more than 40 per cent. Both are thrown away. The richness of the residues prevents the treatment of poor ores by this method.

2. **Liquation of the Sulphur in Apparatus** (Cupola furnaces or covered heaps) with a greater or smaller admission of air, thus burning part of the sulphur in producing the temperature required for liquation. The Sicilian furnaces (calcarelle) cause a greater loss of sulphurous acid (20 per cent of sulphur and more) than the covered heaps (calcaroni), owing to a too speedy combustion. The covered heaps may be placed in the immediate vicinity of dwelling houses and cultivated fields, whilst the older furnaces had to stand some thousands of feet from them and were in operation only in a certain season of the year; working in covered heaps is also less injurious to the health of the workmen. Since 1860, Hill has tried to avoid the noxious influence of the sulphurous acid by melting the ores in high cylindrical furnaces, directing the combustion gases of coal through the furnaces.

Poor and moderately rich sulphurous earths were formerly liquated in Sicily in cylindrical furnaces 6 or 7 feet wide and 4 or 5 feet high, the sole of the furnace being somewhat inclined, and furnished with an open channel for igniting the ores and removing the residues. The furnace had also several openings for admitting air, and one for tapping off the liquated sulphur. The larger pieces of ore were placed inside round the periphery of the furnace, upon a small projecting rim, then a sort of vault was formed of smaller pieces with a small opening at its apex, and upon this still smaller pieces of ore were placed, and lastly covered with ore dust, the whole forming a pyramid. A lining of turf, 7 or 8 inches broad, was placed round the basis of the pyramid, which was covered with straw; by igniting the straw the

heat was made to pass from the outside to the inside. After about 8 hours the fused sulphur had collected on the bottom of the furnace, and was tapped off either in moistened wooden moulds in the form of sticks, or in vessels filled with water.

The sulphurous ores mined in Sicily are classified as follows:—Very rich ores containing 25 per cent of sulphur; rich ores with 20 per cent; good ores with 15 per cent; medium ores with 8 per cent; and poor ores with from 3 to 6 per cent. The working of the poor ores does not pay their mining cost.

In the island of Milos\* in Asia Minor, ores containing 30 per cent of sulphur are liquated in furnaces 1·8 metres high and 5 metres wide, in quantities of 100 tons, yielding not more than from 7½ to 10 tons of pure sulphur.

In Spain,† the oldest Sicilian process is 30 per cent cheaper than the distillation process in iron tubes, and the cost of establishing the furnaces was also less. A Sicilian furnace producing 10 tons of sulphur per month costs £16, whilst a retort furnace producing 15 tons in the same time costs £600. No flowers of sulphur are produced, but ground and sifted sulphur is sold, the production of which is cheaper by 25 per cent.

The liquation in covered heaps‡ is performed in the following manner:—The heap is constructed with an inclined base dug in the sole of the sulphur works, which is coated with a layer of mortar, *a* (Fig. 198), composed of a mixture of gypsum and sand. The depth of this excavation depends on the richness of the ore and on its state of cohesion. The excavation is closed on its working side by a wall, *b*, which is furnished with the tapping hole, *c*. This part of the heap is covered with a wooden shed, *e*. Two or three iron rods, *f*, are then inclined against the front wall, *b*, and larger ore pieces piled up before it, thus forming the open niche, *h*. The excavation, *g*, is also filled with ore, and upon this

\* B. u. h. Ztg., 1863, p. 74.

† Ibid., 1863, p. 334.

‡ Oesterr. Ztschr., 1856, p. 70; 1861, p. 394. BOLLEY, Chem. Technolog., 2, Bd. i., Gruppe, p. 12.

foundation of ore, six or nine small shafts, *i*, are constructed of large pieces of ore, whilst the intermediate space, *k*, is filled

FIG. 198.  
www.libtool.com.cn

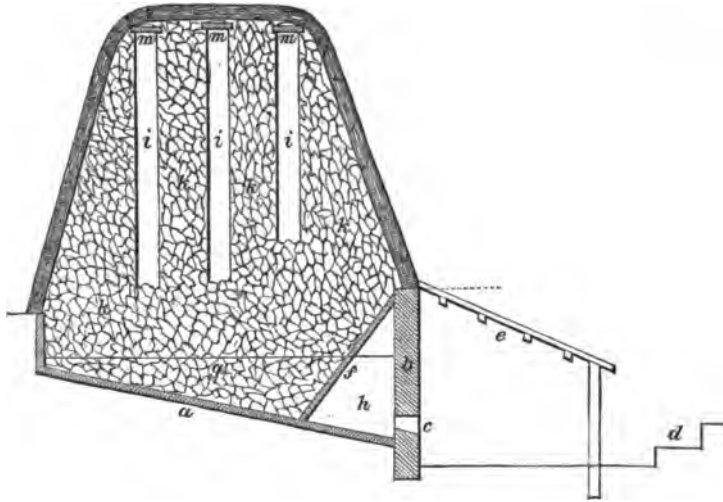

up with ore in such a manner as to place the larger pieces in the middle and the small ore on the periphery of the heap. Care is also taken to leave as many interstices between the pieces of ore as possible. The heap is then covered either with loam or small ore, and upon this are placed pounded residues of a previous charge, if they are to be had, in order to prevent the admission of too much air. A heap contains from 100 to 1000 cubic metres of ore, and is higher than the wall, *b*, by from 2 to 4 metres. When containing 800 cubic metres of ore it burns about two months, and yields 15 per cent of sulphur.

The heap is ignited by throwing into the shafts, *i*, ignited bundles of grass dipped into fused sulphur. After about 12 hours these shafts are covered with the stone plates, *m*; the top of the heap is covered with pounded and moistened residues, and the tapping hole, *c*, is closed. In about 25 days the tapping of the sulphur commences; cracks formed during the operation in the cover of the heap are carefully closed; the sulphur is tapped off from time to time into a



walled reservoir, after having opened the tapping hole, if required, by means of a red-hot iron rod; sulphur which may have ignited in the nich is extinguished by injecting water through *c*. The sulphur is then cast in moistened wooden moulds, forming blocks or lumps (ballate) of about 1 cwt. each. The production of 1 cwt. of sulphur from ores yielding 10 per cent costs 1s. 10d., and that from ores yielding 15 per cent, 1s. 3d.; the total cost, including the transport to Palermo, amounts respectively to 2s. 10d. and 2s. 2d.

3. **Distillation of Sulphur in Closed Vessels (Tubes, Retorts, or Pans).**—This method of extracting sulphur has some disadvantages in comparison with the production of sulphur in covered heaps, which is simpler, cheaper, and allows a large production; the first outlay is much smaller, and the saving of fuel when fuel is not very cheap more than outbalances the smaller yield of sulphur. If fuel is cheap and wages moderate, the production of sulphur by distilling the ores in closed vessels is advisable when working poorer ores, on account of its greater yield.

The furnace used for distillation in Swoszowice,\* near Cracow, is represented by Figs. 199, 200, and 201. It con-

FIG. 199.

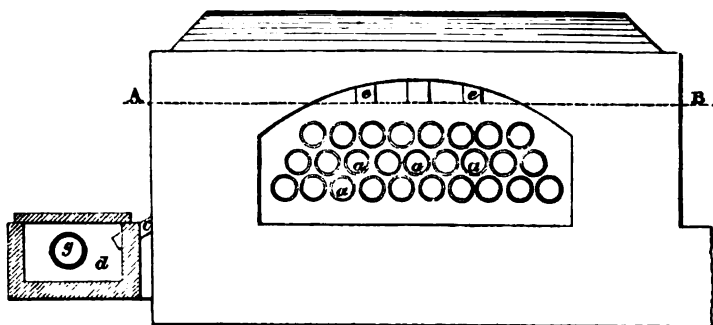

tains 27 cast-iron tubes, *a*, each 3 feet 10 inches long, and 18 inches wide, in three rows. Each row communicates with a cylindrical receiver, *b*, from which the uncondensed vapour of sulphur enters into the condenser, *d*, by means of the

\* B. u. h., Ztg., 1861, pp. 1, 15. WAGNER'S Jahresber. 1862., p. 199.

tube, *c*. Each tube is provided in front with four openings for tapping off the sulphur, three of which are always kept

FIG. 200.

[www.libtool.com.cn](http://www.libtool.com.cn)

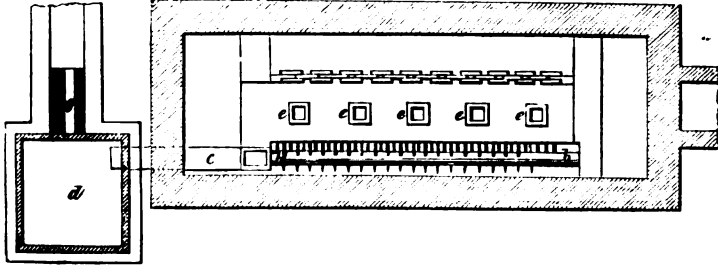
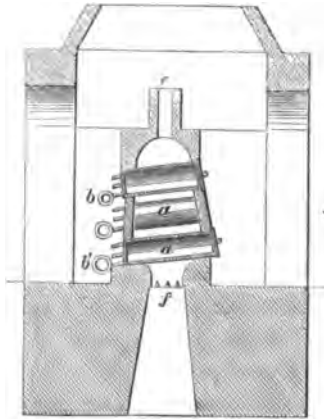

FIG. 201.



closed during the operation, whilst the lowest one is open. When turning the tubes the lowest aperture is opened; *e, e*, are chimneys, *f* the grate, and *g* a tube for evolving the vapours from *d*.

Each tube is charged with from 125 to 130 lbs. of ore; and during twelve hours the lower row of tubes is distilled four times, and the upper one twice; thus the upper row requires six hours for undergoing distillation, the middle row four hours, and the lower one three hours. From 14 to 15 cwts. of raw sulphur are produced in twelve hours; in wet weather from

1½ to 2 cwt. more, containing 10 or 1½ cwt. of coal. The sulphurous earth, containing from 11 to 14 per cent of sulphur, entails a mining cost of about 8·7d. per cwt., and the production of 1 cwt. of raw sulphur costs 8s. 8d.

The distillation process for the separation of the sulphur at the celebrated Solfatara of Pouzzales, near Naples, where the sulphur is condensed in considerable quantities amongst the gravel collected in the circle which forms the interior of the crater, is conducted as follows :—The mixture of sulphur and gravel is dug up and submitted to distillation to extract the sulphur, and the gravel is returned to its original place, and in the course of about thirty years is again rich enough in sulphur for a repetition of the process. The distillation is effected in the following manner :—Ten earthen pots, of about a yard in height, 4½ imperial gallons in capacity, and bulging in the middle, are arranged in a furnace called a gallery, five being set on one side, and five on the other. These are so distributed in the body of the walls of the gallery that their bellies project partly without and partly within, while their tops rise out of the vault of the roof. The pots are filled with lumps of sulphur ore the size of the fist ; their tops are closed with earthenware lids, and from their shoulders proceed pipes about 2 inches in diameter, which bend down and enter into other covered pots, with holes in their bottoms, standing over a tub filled with water. On applying heat to the gallery, the sulphur melts, volatilises, and runs in a liquid state into the tubs, where it solidifies. When one operation is finished, the pots are re-charged, and the process repeated.

In some other Sicilian establishments iron pots or pans are used instead of earthen ones. They are closed with an iron lid, and the distilled sulphur is conducted into iron or earthen vessels. To save time and fuel in this process, the ore, previous to its being charged in the pots, is warmed in a walled chamber, which is heated by the gases escaping from the distilling furnaces.

This process\* has lately been considerably improved. The

\* Quarterly Journal of Science ; London, July, 1868 ; No. xix, p. 413.

new process is as follows:—A vessel, made of boiler plate, in the form of a truncated cone, is filled with the ore of sulphur. There is a grating at the bottom to prevent the ore from falling through into the receiver, and under this a strainer of sheet-iron pierced with small holes. Up the centre—passing from top to bottom—is a pipe communicating with a steam boiler, which pipe is perforated with small holes. The vessel containing the ore is carefully closed, the steam is turned on, and, issuing from the perforated pipe, it finds its way amidst the ore. In the course of a short time the sulphur melts; becoming very liquid, it flows through the grate and the strainer into the receiver in which it is kept in a liquid state, until all the ore in the vessel is exhausted; it is then run off into moulds.

An apparatus of this kind has been put up at the Elvetica Iron Works, and the saving of time, and therefore of money, is very great. The production of sulphur appears to be increased from 20 per cent to  $37\frac{1}{2}$  per cent.

At Radoboi in Croatia, yellowish brown kidney-shaped lumps, containing from 95 to 98 per cent of sulphur, and weighing from  $\frac{1}{2}$  oz. up to several pounds, are worked for the

FIG. 202.

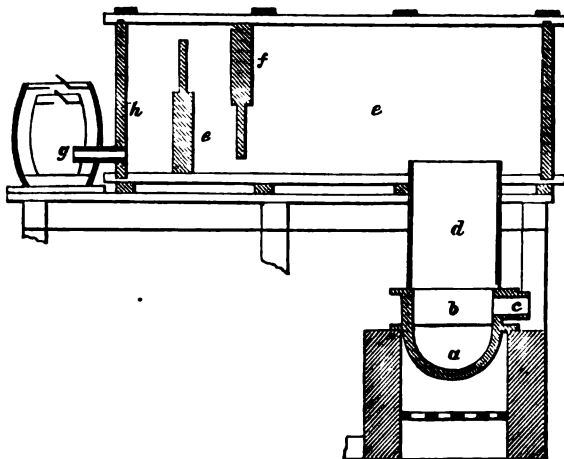

production of flowers of sulphur. The apparatus is represented by Fig. 202. *a* is a cast-iron pan for receiving the

ore in charges of 120 lbs.; *b*, cast-iron cylinder provided with the charging opening, *c*; *d* is a tube of iron plate; *e* is the condenser constructed of wood and iron plate and furnished with partition walls, *f*. The flowers of sulphur collected in this condenser are *finely divided and perfectly free from acid*. The receiver, *g*, communicates with the atmosphere by means of valves, and the flowers of sulphur herein collected contain sulphurous and sulphuric acid; the flowers of sulphur collected in the last compartment, *h*, of the condenser, *e*, also contain some acid. 110 lbs. of flowers of sulphur are produced in 12 hours, with a consumption of about 10 cubic feet of wood. The pan lasts about three years.

## II. Extraction of Sulphur from Iron Pyrites and Pyritic Ores.

If the production of sulphur from iron pyrites is the chief object, this extraction is mostly effected in closed vessels in order to obtain the highest yield, though, on the other hand, the labour and fuel for this method of extraction are more expensive. Cupola furnaces are employed when the prices of fuel and labour are very high, entailing a loss of part of the sulphur to keep up the temperature required for distillation. When employing mounds or open heaps the greater part of the sulphur escapes as sulphurous acid.

**I. Extraction of Sulphur from Iron Pyrites in Closed Vessels.**—The apparatus employed is similar to that described on page 710. The inclined tubes sometimes have separate receivers, each partially filled with water.

The yield of sulphur depends chiefly on the regulation of the firing. The temperature must not be kept too high at the commencement of the operation, or the pyrites will cake and melt, and a great deal of vapour of sulphur escape from the receivers, and the tubes will be burned too much. Pyrites becomes more difficult to fuse towards the end of the operation, and then requires a higher temperature.

At Altsattel\* in Bohemia, the furnaces are furnished with 32 conical earthen tubes, placed in three rows (10, 11, 11). Each

\* B. u. h. Ztg, 1861, p. 237.

tube is 32 inches long,  $1\frac{1}{4}$  inches thick in the sides, 6 inches wide on the back, and  $1\frac{1}{2}$  inches wide in the front, which projects 6 inches from the furnace and is joined with a knee tube which reaches into an iron vessel 1 foot long, 1 foot broad, and 1 foot deep. The iron vessel is filled 6 inches high with water, and the end of the knee tube reaches within 2 inches of the surface of the water. The tubes are charged at the backs or on their wide sides, and after charging the opening is closed with an iron plate. The iron vessel for receiving the distilled sulphur is covered with an iron lid which is furnished with an opening 1 inch wide. As soon as no vapour of sulphur escapes from this opening, the operation is finished. Each tube is charged with about 10 lbs. of pyrites 4 times in 24 hours, excepting the uppermost row, which is charged only three times in 24 hours, and during this time 180 lbs. of raw sulphur (15 per cent) are produced from 12 cwts. of pyrites with a consumption of 40 cubic feet of brown coal.

The raw sulphur is refined by distillation in cast-iron retorts about 2 feet high and 1 foot in diameter; eight of these retorts are placed in a furnace, four on each side, and are provided with a cast-iron receiver the size of the tubes. The distilled sulphur flows from the receiver through an opening which it has, into an earthen pot filled with water, if the production of drop sulphur is intended; otherwise the fused sulphur is poured from the pot into moulds. Five cwts. of raw sulphur yield in eight retorts 460 lbs. (92 per cent) of refined sulphur, from which we may conclude that 1 cwt. of iron pyrites yields 13.8 lbs. of purified sulphur. The residues are used for the production of vitriol.

At Rosenau in Silesia, furnaces with two rows of earthen tubes are employed, the upper having six tubes and the lower nine; each tube is 5 feet long and communicates with cast-iron vessels by means of short elbow tubes. Cold water flows in the first cast-iron vessel, and passes out again from the last vessel in a warm state. A tube is charged with 30 lbs. of iron pyrites, forming a layer in the tubes 3 inches high, and it yields 16 per cent of raw sulphur after being heated for three hours. Three cwts. of raw sulphur are produced

in 24 hours from 1 ton of iron pyrites, in 15 retorts, with a consumption of  $17\frac{1}{2}$  cubic feet of coal. The raw sulphur is distilled in an iron retort, 3 feet high and 2 feet wide in the belly, and provided with earthen receivers. The liquid sulphur collecting in the first two receivers may be tapped off through an opening in the bottom of the receivers, whilst flowers of sulphur are formed in the adjoining receivers. Thirteen cwts. of raw sulphur in six distilling vessels yield about 15 cwts. of purified sulphur in from 30 to 36 hours, and from  $\frac{1}{2}$  to  $\frac{1}{2}$  cwt. of flowers of sulphur per month. The residues are used for producing iron vitriol and alum.

2. **Extraction of Sulphur from Pyrites in Cupola Furnaces.**—Although cheaper, these furnaces are less often used for the extraction than closed vessels, as they only yield half as much sulphur, and as their temperature is difficult to regulate, causing the ores to cake or melt easily. These furnaces are sometimes in the shape of a truncated pyramid, and sometimes of a truncated cone; the conical form is preferable, as it allows a more uniform roasting.

At Johann-Georgenstadt a cupola furnace was used 11 feet high, 8 feet broad, and 9 feet long in its base, and tapering to its top to a surface of 3 square feet. The mouth of the furnace was provided with a lid for closing it. An opening on the sole of the furnace served to introduce a layer of fuel and to remove the pyrites. The furnace was provided,  $6\frac{1}{2}$  feet above its bottom, with four openings, 6 inches square, to conduct the vapour of sulphur into a walled chamber 5 feet square and 7 feet high. From this chamber the sulphurous acid was conducted by means of a flue 2 feet broad and 18 inches high, into a space 100 feet long, part enclosed by wooden boards, and part by walls. This space contained pyrites which had once been lixiviated, and was intended for another lixiviation for its iron vitriol. A furnace contained 15 tons of pyrites and yielded in 10 or 12 days from 15 to 17 cwts. of raw sulphur.

A conical furnace was employed at Breitenbrunn (Erzgebirge). It was 12 feet high, 3 feet and 12 feet in diameter on the top and bottom respectively. A channel received the condensed vapours of sulphur 8 feet above the bottom, and

conducted them into a chamber 10 feet high, 4 feet long, and 2 feet broad, whilst the sulphurous acid was made use of as in Johann Georgenstadt. 15 tons of ores were roasted in seven or eight days.

In Simbirsk\* (Russia), cupola furnaces are used for producing sulphur.

Brunfaut† roasts pyrites in cupola furnaces with steam and atmospheric air alternately, thus producing sulphuretted hydrogen gas and sulphurous acid, and sulphur by the contact of both gases.

The extraction of sulphur in mounds and open heaps has been described in former chapters.

### III. REFINING OR PURIFYING THE RAW SULPHUR.

The refining is effected either by re-melting or distilling the raw sulphur. The sublimed sulphur is obtained either in a liquid or a pulverulent state, according to the higher or lower temperature in the condensation chambers.

1. **Purification of the Sulphur by Re-melting.**—At the Lower Hartz the very impure raw sulphur, produced by roasting lead and copper ores in open heaps, is melted in quantities of 3·52 cwts. for 2½ or 3 hours in a cast-iron pan, 4 feet long, 2 feet broad, and 1 foot deep. The sulphur is then cooled to from 200° to 160° C., skimmed off, and ladled into a copper pan, 1 foot 7 inches deep, and 2 feet 7 inches in diameter, and thinly coated with loam by means of copper ladles. It is allowed to clarify in the copper kettle for ¼ or ¾ hour, and is then poured into wooden moulds at a suitable temperature. If ladled out too soon the sulphur will be impure, and if submitted to too low a temperature much pure sulphur will deposit in the kettle. The proper temperature is indicated when a thin crust forms on the surface of the sulphur. The residues are melted in quantities of 4 or 5 cwts. and filtered through coarse canvas. The filtered mass is added to the raw sulphur, and the residue on the

\* Bgwkfd., xx., 348.

† B. u. h. Ztg., 1861, p. 446.



filter, containing 6 per cent of arsenic, is sold. In 1861, from  $24\frac{1}{2}$  tons of raw sulphur were produced  $22\frac{1}{2}$  tons of good yellow sulphur (89.7 per cent), and 21 cwts. of gray sulphur, with a consumption of 240 pieces of wood and of 66 cubic feet of coal.

2. Purification of Sulphur by Distillation.—The apparatus most commonly used is that of Marseilles. It is represented by Figs. 203 and 204. The two cast-iron cylinders, *a*,

FIG. 203.

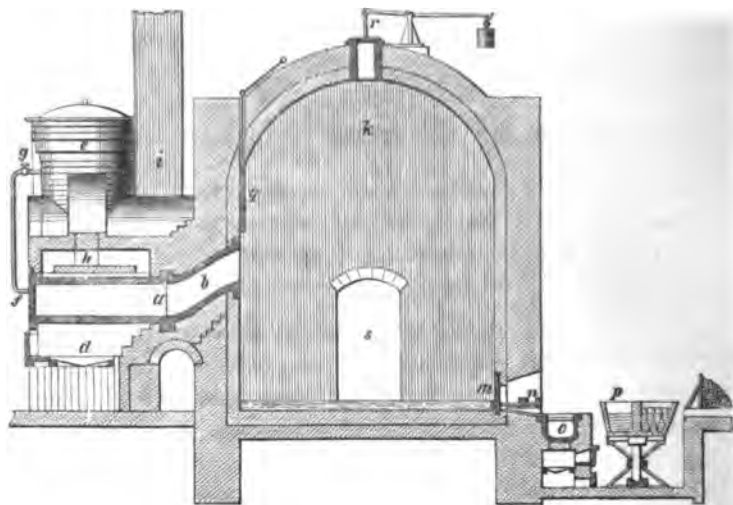
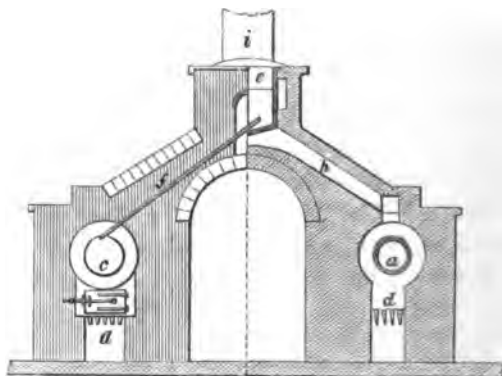

FIG. 204.



1.5 metres long and 0.5 metre wide, are charged each with 600 lbs. of raw sulphur. The charging opening is then closed with the luted lid, *c*, and fire is given to one of the cylinders, whilst the second cylinder is not heated until the distillation in the first is half finished. The flame from the grate, *d*, enters the flues, *h*, heating the pan, *e*, 1 metre deep and as wide, and closed with an iron lid. In this pan 15 or 16 cwts. of raw sulphur are melted, about 6 cwts. of which are made to run into the first cylinder by means of the tube, *f*, after it has distilled off its charge. As soon as the pan, *e*, is emptied to a certain degree, the cock, *g*, is closed, the tube, *f*, removed, and the opening in the lid, *c*, closed with a clay plug. The combustion gases, after having played round the kettle, *e*, enter the chimney, *i*. The vapours of sulphur are conducted by the tube, *b*, into a walled condensation chamber, *k*, 8 metres long, 4 metres deep, and 5 metres high, and carefully coated with mortar; in this they condense, at first forming a powder; but as soon as the temperature of the condensation chamber is raised above 112° C. by the continued distillation, fluid sulphur collects on the sole of the chamber and runs into the warmed pan, *o*, on opening the hole in the iron plate, *m*, by means of the cock, *n*. The sulphur is then ladled into wooden conical moulds standing in the tub, *p*. The moulds are closed on one side with a wooden plug, which is removed after the sulphur has solidified, and the stick of sulphur is pushed out. The sliding door, *q*, serves to regulate the admission of sulphur vapours, and the safety-valve, *v*, allows the escape of the air expanding in the chamber. One cylinder is charged every 4 hours. 36 cwts. of sulphur are distilled in six operations, during 24 hours. The production of 1 cwt. of stick sulphur costs about 8s. When aiming at the production of flowers of sulphur, instead of fused sulphur, the only alteration necessary is an enlargement of the condensation chamber, or the curtailment of the number of distillations to two in 24 hours, each with 3 cwts. of raw sulphur; both modifications will decrease the temperature in the chamber. When a layer of flowers of sulphur 0.5 or 0.6 metre high becomes deposited in the chamber it is to be removed by the door, *s*; the flowers of sulphur may contain

a certain amount of sulphurous and sulphuric acid, which may be removed by washing them. The production of 1 cwt. of flowers of sulphur costs about 9s. 6d.

Dujardin's method\* at Mexem, near Antwerp, is said to give still better results by economising fuel and more effectually preventing the admission of air to the distilling vessels and to the condensation chamber.

The apparatus is represented by Figs. 205, 206, and 207.

FIG. 205.

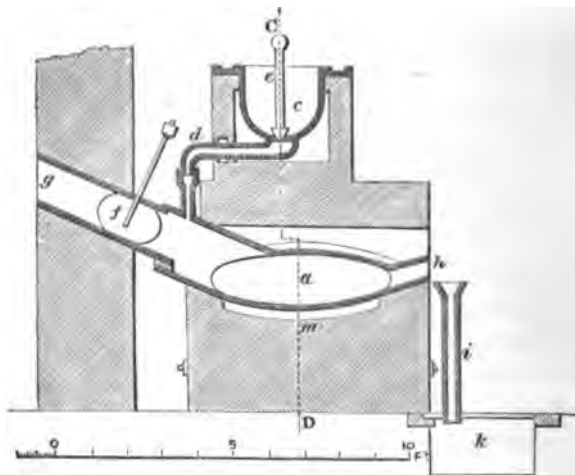
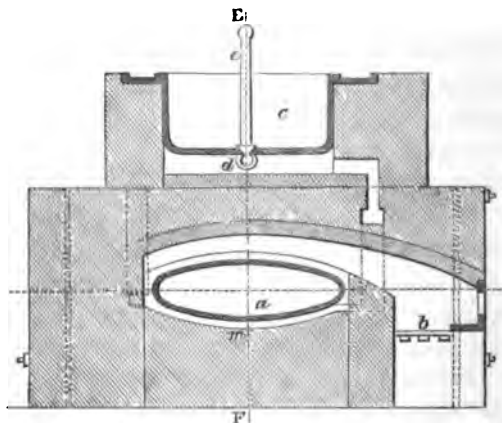
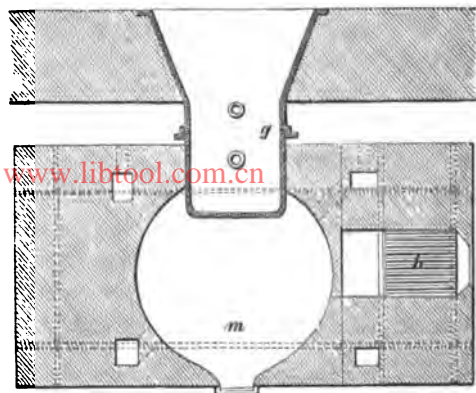

FIG. 206.



\* B. u. h. Ztg., 1864, p. 204.

FIG. 207.



The lens-shaped, cast-iron body, *a*, is heated by the flame produced on the grate, *b*. This flame also heats the pan, *c*, which communicates with *a* by the elbow-tube, *d*. This tube may be closed by the stopper, *e*; 12 cwts. of raw sulphur are melted in *c*, and the liquid mass, including the impurities, is made to pass into *a*; the pan is then closed by means of the stopper, *e*. The vapours of sulphur produced in *a* are conducted into a condensation chamber by the tube, *g*, which may be closed by the valve, *f*. The distillation is finished in about four hours; the valve, *f*, is then closed, the residues removed by *h*, and conveyed into the basin, *k*, by means of the tube, *i*, and a new distillation begins. Six charges are distilled every 24 hours, consuming 10 cwts. of semi-bituminous coal. The distilled sulphur is cast into moulds every five or six days. When aiming at the production of flowers of sulphur, only 8 cwts. of sulphur are distilled in 24 hours. The residues are nearly free from sulphur, and the loss of sulphur is small: this loss amounts to 0.73 per cent when working raw sulphur containing 1.5 per cent of impurities. At Namur an iron cylinder is used instead of condensation chambers. 1500 tons of sulphur are refined at Merxem annually in eight furnaces.

In some German establishments a simpler apparatus is used, consisting of two iron pans, 1 metre in diameter and 1 metre  
VOL. I. 3 A

high ; they stand about 2 metres distant from each other and are connected by an elbow tube, screwed so as to be fixed hermetically to both pans. One of the pans stands above a grate, and is charged by a hopper which passes through the elbow tube. The residues are removed by another tube, which is hermetically joined to the bottom of the pan. The produced vapours of sulphur are conducted by means of the elbow tube into the second pan, where they condense, and the liquid sulphur is withdrawn by a cock. This pan is surrounded by brickwork to maintain the sulphur liquid ; that part of the elbow tube lying nearest to this pan is likewise jacketed so as to prevent condensation of the sulphur in the tube, when it would otherwise flow back into the first pan.

# SUPPLEMENT.

[www.libtool.com.cn](http://www.libtool.com.cn)

THE following comparisons of the dimensions of different reverberatory furnaces, and the conclusions to be drawn from them, may be fitly given here :—

	GRATE.			HEARTH.			PROPORTION.				Distance of the Arch from the	
	Breadth. 1	Length. L	Surface. m <sub>2</sub>	Breadth. L'	Length. l'	Surface. m <sub>2</sub>	S	S'	L	L'	Hearth.	Fire-bridge
English roasting reverberatory furnace for lead ore . . . . .	m. 0'65	m. 1'40	0'91	m. 2'5—2'4	m. 3'70	9'15	10	10	1'8	1'5	—	—
Carinthian lead furnace . . . . .	0'47	1'35	0'63	1'46	3'34	4'2	6'6	1'0	2'1	—	—	—
Lead furnace at Engis . . . . .	0'4	1'5	0'6	1'25	2'1	2'5	4'1	0'8	1'6	—	—	—
English cupelling furnace . . . . .	0'40	1'20	0'48	1'10	1'60	5'52	11'5	0'9	1'4	m. 0'55	m. 0'40	—
Cupelling furnace in the Hartz . . . . .	0'50	1'40	0'70	3'1	3'10	7'54	10'8	2'0	1'0	1'0	1'50	0'40
English roasting furnace for copper ore . . . . .	0'90	1'20	1'08	4'3	5'25	22'575	20	3'5	1'2	—	—	—
Mansfeld double furnace . . . . .	0'50	2'00	1'00	2'6	2'6	4'5	5—4	1'3	1'0	—	—	—
Annealing furnace . . . . .	0'7	1'3	0'91	1'4—0'5	2'4	3'12	3'4	1'0	1'7	—	—	—
Reverberatory furnace for re-melting iron plates . . . . .	1'00	1'6	1'6	1'4	3'2	4'48	2'8	0'87	2'3	—	—	—
Reverberatory furnace for heating iron plates . . . . .	1'3	1'12	1'45	1'12	3'18	3'55	2'5	1'0	2'8	0'78	0'33	—
Puddling furnace . . . . .	0'8	1'3	1'04	1'3—0'5	2'1	2'31	2'2	0'89	1'9	0'60	0'30	—
do. at Belgium . . . . .	1'0	1'0	1'0	1'0—0'5	1'5	1'5	1'5	1	1'5	0'5	0'4	—

The following conclusions may be drawn from this table :—

a. If the surface of the grate is the same, the surface of the hearth is modified according to the heat which is to be produced, and consequently the hearths of roasting furnaces are two or three times larger than those of smelting furnaces ; and the latter are again one-and-a-half times larger than those of puddling furnaces. In the same process the proportion of the hearth to the grate may vary from 10 to 4·1, but such large differences have a considerable influence upon the process, as is shown by the following table :—

	Proportion of the hearth to the grate.	Proportion of the hearth in square cent. to the charge in kil. during 24 hours.	Proportion of the fuel to the charge.
Carinthian lead furnace .. .. (16 wood = 8 to 10 coal)	6·6	64 c <sub>2</sub> to 1 kil.	8—10
Lead furnace of Engis .. ..	4·1	23 " "	6
English lead furnace .. ..	10	20 " "	5·2

It follows from this that in England more substance is treated on 1 m<sub>2</sub> hearth in one hour with a smaller consumption of fuel, but with more labour, as it is oftener necessary to rearrange the melting mass on the larger hearth, which is less uniformly heated on account of its size.

b. The length of the grate is usually equal to the breadth of the hearth, which is from 1 to 2·5 times as long as it is broad. The height of the arch above the hearth is 0·6 to 1 metre, and above the fire-bridge 0·3 metre. Upon one square decimetre of the surface of the grate 0·5 to 1 kilos. of coal and 1 to 1·5 kilos. of wood, or respectively 0·5—1 and 2·8—4·2 cubic decimetres are burned in one hour. In the lead furnace at Engis, for instance, 1000 kilos. of ore consume 650 kilos. of coal, and 0·45 kilo. of coal correspond with 0·66 square decimetre of the surface of the grate.— (Havrez in *Revue Universelle*, 6 an. 3 livr., 1862, p. 405.)

[www.libtool.com.cn](http://www.libtool.com.cn)

# INDICES.



[www.libtool.com.cn](http://www.libtool.com.cn)

CLASSIFIED INDEX  
OF  
SMELTING WORKS AND MINING DISTRICTS.

- A** GORDO, Venetian Alps (*Sulphur*), 706  
 Algeria (*Lead*), 154  
 Alps (*Platinum*), 681  
 America, North (*Lead*), 73, 74  
 — — California (*Silver*), 358, 360;  
 (*Mercury*), 507, 508, 517, 521, 525,  
 530; (*Gold*), 611, 622, 623, 626  
 — — Mexico (*Silver*), 331, 335, 342,  
 362; (*Gold*), 626  
 — — Pennsylvania (*Zinc*), 458  
 — — United States (*Gold*), 658  
 Australia (*Silver*), 392; (*Gold*), 615,  
 623, 626  
 Austria, Bohemia (*Gold*), 624; (*Sul-*  
*phur*), 706  
 — — Altsattel (*Sulphur*), 706, 714  
 — — Brandhotz (*Antimony*), 542  
 — — Breitenbrunn (*Sulphur*), 706,  
 716  
 — — Horowitz, (*Mercury*), 527  
 — — Joachimsthal (*Lead*), 79, 81,  
 112, 118; (*Silver*), 219, 225, 392;  
 (*Bismuth*), 538; (*Nickel*), 566, 569,  
 572, 578  
 — — Przibram (*Lead*), 79, 85, 110,  
 115, 120, 125, 179, 185; (*Silver*),  
 288, 311; (*Zinc*), 417  
 — — Schlaggenwald (*Tin*), 485, 479  
 — — Zinnwald (*Tin*), 476, 485, 490,  
 491.  
 — Carinthia (*Gold*), 624  
 — — Bleiberg and Raible (*Lead*), 27,  
 74  
 — Croatia (*Sulphur*), 706, 71
- Austria, Hungary (*Mercury*), 509;  
 (*Nickel*), 569; (*Gold*), 624  
 — — Lower Hungary (*Lead*), 142;  
 (*Silver*), 220, 228, 230, 237  
 — — — Kremnitz (*Lead*), 198;  
 (*Silver*), 293; (*Gold*), 671  
 — — — Magurka (*Antimony*), 544,  
 549  
 — — — Schemnitz (*Lead*) 79, 181,  
 191; (*Gold*), 631, 632, 643  
 — — — Schmöllnitz (*Silver*), 334  
 — — — Stadtgrund (*Lead*), 191  
 — — — Tajova (*Lead*), 144; (*Silver*),  
 333, 376  
 — — Upper Hungary (*Silver*), 220  
 — — — Arany Idka (*Silver*), 315,  
 327, 329  
 — — — Fernezely (*Lead*), 181  
 — — — Nagybanya (*Silver*), 246,  
 (*Antimony*), 541, 547  
 — — — Stephanshütte (*Silver*), 332,  
 375  
 — Idria (*Mercury*), 507, 511, 518, 521,  
 — Salzburg (*Silver*), 229, 238; (*Gold*),  
 624, 631; (*Sulphur*), 706  
 — Steyermark, Styria (*Sulphur*), 706  
 — Transylvania (*Silver*), 246, 334;  
 (*Mercury*), 527; (*Gold*) 624, 627,  
 628, 648  
 — Tyrol (*Silver*), 246; (*Gold*), 627,  
 631, 635
- B** ANCA (*Tin*), 488  
 Belgium, Andenne (*Zinc*), 425  
 — Angleur (*Zinc*), 420, 430

- Belgium, Corphalie (*Lead*), 59, 91;  
(*Zinc*), 412, 435  
— Jemappe (*Zinc*), 459  
— Liège (*Nickel*), 568  
— Merxem (*Sulphur*), 720  
— Valentin, Cocq and Flone (*Zinc*),  
448, 454  
— Welkenrath (*Zinc*), 411  
Billitan (*Tin*) 488  
Bolivia (*Silver*), 342; (*Gold*) 624  
Borneo, (*Gold*), 623  
Brazil (*Silver*) 362; (*Gold*), 623, 625,  
627; (*Platinum*), 679
- C**HINA (*Gold*), 624; (*Mercury*),  
507.  
Choco (*Platinum*), 679  
Corsica (*Lead*), 154
- E**AST INDIES (*Antimony*), 541
- F**RANCE (*Lead*), 76  
— Ardèche, Malbosc (*Antimony*),  
543, 546  
— Bretagne, Velleder (*Tin*) 476, 498  
— Dieuze, near Nancy (*Sulphur*), 699  
— Haut Loire, Lincolun (*Antimony*),  
545  
— Huëlgoet (*Lead*), 55; (*Silver*), 309,  
331  
— Isère, Allemont (*Silver*), 220  
— Marseilles (*Sulphur*), 718  
— Pezey (*Lead*), 182  
— Pontgibaud (*Lead*), 150, 178, 182;  
(*Silver*), 289, 314  
— Poullaouen (*Lead*), 55, 170, 175;  
(*Silver*), 218, 309, 327; (*Tin*), 489  
— Rhone (*Lead*), 64, 120  
— — Bouc (*Antimony*), 550, 543  
— — Escalette (*Lead*), 68, 154  
— — Rouet (*Lead*), 196  
— — Septèmes (*Lead*), 155; (*Anti-*  
*mony*), 550, 553  
— — St. Louis (*Lead*), 67, 154  
— Southern (*Lead*), 154  
— Vendée, Ramée (*Antimony*), 542  
— Vialas (*Lead*), 118, 119, 153;  
(*Silver*), 291, 315,  
— Vienne (*Lead*), 67
- G**ERMANY, Baden (*Gold*), 624  
— — Marienhütte (*Lead*), 113  
— — Münsterthal (*Lead*), 113  
— — Bavaria (*Gold*), 624  
— — Palatinate (*Mercury*), 525,  
527, 528  
— Prussia, Frankfort (*Gold*), 671  
— — Hartz, Wilhelmshütte (*Plati-*  
*num*), 681
- Germany, Prussia, Hartz, Wolfsberg  
(*Antimony*), 541, 543  
— — Lower Hartz, Goslar-Oker  
(*Lead*) 116, 119, 121, 176; (*Silver*),  
399, 400; (*Nickel*), 563; (*Gold*),  
636, 666; (*Sulphur*), 706, 717  
Germany, Prussia, Lower Hartz,  
Victor-Friedrichshütte (*Lead*), 86,  
96, 108; (*Silver*), 307  
— — Upper Hartz (*Lead*) 53, 79, 81,  
85, 86, 96, 97, 98, 176, 177, 183,  
191; (*Silver*), 218, 219, 258, 259,  
260, 263, 267, 277, 287, 306; (*Zinc*),  
458; (*Nickel*), 564, 567; (*Arsenic*),  
590, 598, 602, 607  
— — Hesse, Gladenbach (*Nickel*),  
560, 569  
— — Mansfeld (*Silver*), 187, 313, 365,  
379; (*Nickel*), 562, 566, 582  
— — Nassau, Dillenburg (*Nickel*),  
558, 570, 571, 580  
— — — Ems (*Lead*), 113, 114, 116,  
159, 176, 186; (*Silver*), 289, 306,  
— — — Holzappel (*Lead*), 32, 144,  
175, 185; (*Silver*), 262, 264, 294  
— — — Provinces of the Rhine (*Gold*),  
623; (*Platinum*), 681  
— — — — Altenberg,  
Moresnet, near Aix-la-Chapelle  
(*Zinc*), 410, 411, 420, 429, 430, 434.  
— — — — Commern (*Lead*),  
114, 116, 120  
— — — — Neighbourhood of  
Stolberg near Aix-la-Chapelle  
(*Lead*), 60, 91, 116, 120, 156, 158,  
192, 195; (*Silver*), 268, 274, 301;  
(*Zinc*), 414, 445, 446, 452, 466  
— — — — Siegen, Lohe (*Lead*), 145; (*Silver*)  
221, 293  
— — — — Müsen (*Lead*), 114, 116, 119,  
145, 185; (*Silver*), 221  
— — — — Rothenbach (*Lead*) 114, 116,  
145  
— — — — Silesia (*Lead*), 79; (*Zinc*), 436,  
442, 458, 462; (*Cadmium*), 469;  
(*Gold*), 624  
— — — — Reichenstein (*Arsenic*), 586,  
588, 590, 596, 602, 607; (*Gold*),  
638  
— — — — Rosenau (*Sulphur*), 766, 715  
— — — — Tarnowitz (*Lead*), 76, 93, 96,  
109, 176, 180, 181, 186, 187;  
(*Silver*), 260, 263, 269, 290, 295,  
308, 317  
— — — — Westphalia, Borbeck (*Zinc*), 413,  
415, 449, 454, 466  
— — — — Oberhausen (*Zinc*), 413  
— — — — Ramsbeck (*Lead*), 159  
— — — — Schwarzburg-Rudolstadt (*Gold*),  
624  
— — — — Saxony (*Arsenic*), 605; (*Sulphur*),  
706

Germany, Saxony, Altenberg (*Tin*), 475, 476, 478, 482, 483, 490, 491; (*Arsenic*), 589, 590, 591, 596  
 — — Freiberg (*Lead*), 79, 115, 119, 127, 176, 178, 181, 185, 187, 197; (*Silver*), 219, 220, 221, 225, 226, 227, 239, 246, 271, 292, 312, 321, 327, 371, 397; (*Nickel*), 561, 563, 567; (*Arsenic*), 600; (*Gold*), 653  
 — — Schneeberg (*Bismuth*), 537  
 — — Schleich (*Antimony*), 541  
 Guinea (*Gold*), 625  
 Great Britain, England (*Silver*), 270, 271, 309; (*Sulphur*), 692  
 — — — Birmingham (*Nickel*), 562  
 — — — Bristol (*Lead*), 37, 39, 44, 192; (*Silver*), 265  
 — — — Cornwall (*Lead*), 37, 39, 50, 193; (*Silver*), 265; (*Tin*), 475, 476, 477, 479, 483, 484, 495, 499; (*Arsenic*), 590  
 — — — Cumberland, Alston Moor, and Nenthead (*Lead*), 42, 69, 71; (*Silver*), 265  
 — — — Derbyshire (*Lead*), 35, 50  
 — — — Durham (*Lead*), 69  
 — — — Flintshire (*Lead*), 35, 37, 39, 44, 50, 51, 174, 193  
 — — — Northumberland (*Lead*), 69  
 — — — Newcastle (*Lead*), 37, 39; (*Silver*), 265, 300  
 — — — Isle of Anglesea (*Sulphur*), 691  
 — — — Isle of Man (*Lead*), 37  
 — — — Scotland (*Sulphur*), 705  
 — — — Wales (*Lead*), 35, 37; (*Silver*), 359; (*Gold*), 359  
 — — — Swansea (*Zinc*), 434; (*Gold*), 675  
 — — — Llanelly (*Silver*), 316; (*Zinc*), 434  
 — — — Llansamlet (*Zinc*), 415, 428, 439, 447, 460  
 — — — Morriston (*Zinc*), 412, 416, 430, 449  
 — — — Neath (*Zinc*), 455  
 — — — Wigan (*Zinc*), 434  
 — — — Wrexham (*Zinc*), 434

**H**AYTI (*Platinum*), 680

**M**ALACCA (*Tin*), 488  
 Milos (Asia Minor) (*Sulphur*), 708

**N**APLES (*Sulphur*), 691  
 Norway, Kongsberg (*Silver*), 217, 226, 228, 234, 290, 310  
 — — Modum (*Nickel*), 578

**P**ERU (*Tin*) 489; (*Mercury*), 514  
 Piedmont, Varallo (*Nickel*), 560  
 Portugal (*Gold*), 625  
 Pouzzales near Naples (*Sulphur*), 689, 712

**R**USSIA, Altai (*Lead*), 163; (*Silver*), 224, 234, 293  
 — — St. Petersburg (*Gold*), 653, 657, 661 (*Platinum*), 682, 684  
 — — Siberia (*Lead*) 96; (*Gold*), 625  
 — — — Barnaul (*Lead*), 181  
 — — — Kuschna (*Gold*), 624  
 — — Simbirsk (*Sulphur*), 717  
 — — Ural (*Gold*), 622, 623

**S**ARDINIA (*Lead*), 37, 64, 187; (*Gold*), 623, 624  
 Savoy, Pezey (*Lead*), 59  
 Sicily (*Sulphur*), 689, 706  
 — — Cattolica (*Sulphur*), 689  
 — — Girgenti (*Sulphur*), 689  
 — — Licata (*Sulphur*), 689  
 — — Caltanisetta (*Sulphur*), 689  
 — — Caltascibetta (*Sulphur*), 689  
 — — Centorbi (*Sulphur*), 689  
 — — Sommatino (*Sulphur*), 689  
 Spain (*Lead*), 33, 46, 52, 64, 76, 119, 154, 155, 165, 188; (*Zinc*), 410; (*Tin*) 448; (*Antimony*), 541; (*Sulphur*), 706, 708  
 — — Almaden (*Mercury*), 507, 514  
 — — Catalonia, Ribas (*Arsenic*), 586, 589, 601, 606  
 Sweden Fahlun (*Lead*), 125  
 — — Kiefva (*Nickel*), 560, 579  
 — — Sala (*Lead*), 96, 113

**T**HIBET (*Gold*), 625  
 Tuscany, Bottino (*Lead*), 64, 155, 181  
 — — Castellazara (*Mercury*), 507, 520  
 — — Ripa (*Mercury*), 507, 520

**V**ENETIA, Valleta (*Mercury*), 508, 521

## I N D E X .

- A**  
bdarr process, 246  
Abstrich, 276  
Abzug, 279  
Agents for precipitating gold, 672  
ALBERTI'S furnace, 521  
Aludel Furnaces, 514  
Amalgam, 202  
— sodium, 349  
— distillation of, 327  
— treatment of, 327  
Amalgamation in casks (European process), 319  
— in heaps (American process), 335  
— of gold, 617  
— of silver ores, 319  
— process, 210, 317  
American hearth process, 72  
Annabergite, 555  
Antimony, 540  
— crude, production of, 541  
— — liquation of in reverberatory furnaces, 542  
— — — in crucibles, 543  
— crude, liquation of in vessels standing in closed furnaces, 544  
— native, 205  
— ore, grey, 540  
— oxide of, 540  
— raw, purification of, 552  
— red, 540  
— regulus of, production of, 546  
— — — from crude antimony, 547  
— — — — direct from ores, 549  
Argentiferous matt, amalgamation of, 331  
— desilverising of by lead ores and products, 237  
— — — by lead products and copper, 245  
Argentiferous matt, desilverising of by metallic lead, 233  
— — lead process with, 233  
— — smelting of with black copper, 246  
Arsenic, 584  
— glass, production of, 593  
— — coloured, production of, 602  
— — white, 595  
— metallic, production of, 585, 588  
— native, 205, 209, 584  
Arsenical antimony, 584  
Arsenical pyrites, 585  
Arsenious acid, analyses of, 595  
— — production of, 590  
— — — in gas reverberatory furnaces, 600  
— — — in muffle furnaces, 596  
— — — in reverberatory furnaces with direct firing, 599  
— — pulverulent, 590  
AUGUSTIN'S process, 364  
— — for the treatment of black copper, 376  
— — — — copper matt, 368  
— — — — speiss, 375
- B**  
ACKWOOD'S hearth, 73  
Berthierite, 540  
Bismuth, 532  
— extraction of by the liquation process, 533, 536  
— — — by smelting in crucibles, 535, 538  
— glance, 532  
— native, 532  
— purification of, 533  
Bournonite, 204  
Brightening, 284  
Bromite, Bromagyrite, 203  
Browse, 71

BRUNTON'S patent calciner, 479

**C**ADMIA fornacum, 468

Cadmium, 468

— production of, 468

Calamine, 205, 402

Carinthian reverberatory process, 24, 27

Cassiterite, 471

Castilian furnace, 46, 48

Chloantite, 554

Cinnabar, 504

Clay, 425

Cobalt ores, argentiferous, 209

Copper, argentiferous, extracting its silver by means of lead, 216

— black, amalgamation of, 333

— — argentiferous, treating with lead, 247

— glance, 204

— matt, roasted concentrated, treatment of with dilute sulphuric acid, 212

— nickel, 555

— ores, 128

— — argentiferous, 204

— — treatment of, 221

— — oxidised, 204

— — variegated, 204

— purified raw, treatment of with dilute sulphuric acid, 212

— pyrites, 204, 208

CROOKES'S amalgamation process, 211, 347

Cupellation, the English system, 295, 300

— the German system, 275, 287

Cupelling furnaces, 276

— the raw lead, 274

— with after-charge, 292

— — concentration of the raw lead, 295

— without after-charge, 289

Cupola furnace, CASSIGNY'S, 520

— — construction of, 90

— — process, 75, 93

**D**ROSS, reduction of, 182, 183

**E**ISEN-NICKELKIES, 555

Emerald nickel, 555

Embolite, 203

English reverberatory process, 35, 37,

— — — modifications of, 50

**F**ALLOW ores, 204

Flux ores, 128

— — roasting the, 138

French precipitation or Vienne process, 65, 67

— reverberatory process, 54, 55

Furnaces, bottoms of, treatment of, 186

**G**ALENA, 1, 204

— argentiferous, 207

Giftmehl, 590

— refining of, 593

Gold, 609

— argentiferous, production of, 622

— chief modes of extracting, 621

— extraction of, and silver at the same time from auriferous and argentiferous substances by chlorination, 645

— extraction of by cementation, 650

— — — — grey antimony ore, 649

— — — — KISS'S method, 646

— — — — litharge and sulphur, 649

— — — — lixiviation with sulphuric acid, 647

— — — — means of aqua regia, 672

— — — — nitric acid (quartation), 651

— — — — PATERA'S method, 647

— — — — PLATTNER'S process, 638

— — — — RÖSZNER'S method, 647

— — — — smelting gold sand, 625

— — — — washing gold sand, 623

— — — — and amalgamating gold sand, 624

— — — — — sulphuretted ores, 632

— — — — from auriferous copper, silver, and lead ores by fusion with lead, 635

— — — — auriferous quartz, 626

— — — — — by CALVERT'S method, 645

— — — — copper, 674

— — — — earthy minerals, 625

— — — — gold sand, 622

— — — — (parting) from silver, 641

— — — — — in the dry way, 649

— — — — — in the wet way, 651

— — — — from sulphuretted ores

— — — — — and smelting products by solution and precipitation, 636

— — — — in cast-iron vessels, 669

— — — — platinum vessels, 664

— — — — porcelain vessels, 666

— grains in the slag, 659

— mines, Australian, 615

— — Californian, 611

— native, 609

— telluride of, 610

**H**ÄHNER'S furnace, 518

**L**EAD, 1

— argentiferous, production of,

212

- Lead, argentiferous, treatment of, 221**  
 — calculation of in Kremnitz, 198  
 — — — by BAKER'S method, 199  
 — — — — PONTIFEX and GLASS-  
 FORD'S method, 199, 200  
 — extraction of in hearth furnaces, 68  
 — fume, 23, 71, 106, 121, 147, 153  
 — hearth ends, 24  
 — furnaces, comparison of, 79  
 — hard, 183  
 — — analyses of, 183  
 — matt, 96, 104, 121, 123, 125, 135,  
 147, 152, 164  
 — — treatment of, 105, 145, 148  
 — ores, 1, 127  
 — — argentiferous, 204  
 — — decomposition of by means of  
 iron (precipitation process), 82  
 — — influence of foreign substances  
 contained in, 6  
 — — oxidised, 9  
 — — and products, treatment of,  
 12, 161  
 — — preparation of, 7  
 — — roasting of, 114  
 — — roasted, smelting of, 117  
 — — — — — illustrations of, 121  
 — — sulphuretted, smelting of, 10  
 — — — — — (the reverberatory  
 process), 13  
 — — — — — products of, 22  
 — — — — — treating of by the roasting pro-  
 cess in reverberatory furnaces, 14  
 — — white, 4, 204  
 — — reduction of in cupola fur-  
 naces, 162  
 — — — — — reverberatory fur-  
 naces, 161  
 — — yellow, 5  
 — — oxidising smelting of in air rever-  
 beratory furnaces, 192  
 — — — — — blast reverberatory  
 furnaces, 196  
 — purification of, 188  
 — raw, 22, 71, 96, 103, 123, 125, 135,  
 147, 152, 164  
 — extraction of silver from, 213, 251,  
 — residues, 22  
 — skimming the, 190  
 — slags, 44, 71, 121, 124, 137, 142,  
 147, 153, 164  
 — — products of, 44  
 — — reduction of, 186  
 — — — — — illustrations of, 187  
 — — smelting of, 42  
 — smelted, stirring of with a birch  
 pole, 191  
 — speiss, 97, 107, 121, 124, 137  
 — sulphate of, 5  
 — — — — — reduction of, 168  
 — synopsis of processes for the ex-  
 traction of, 6
- Litharge, 282, 283, 284**  
**Liquation process, 191, 250**  
**Litharge, reduction of, 171**  
 — — — — — in cupola furnaces, 176  
 — — — — — illustrations of, 177  
 — — — — — in hearth furnaces, 180  
 — — — — — in reverberatory furnaces,  
 172  
 — — — — — illustrations of, 172
- MEGABROMITE, 203**  
 Mercurial fallow ores, 504  
 — residues, 524  
 — soot or fume, 524  
**Mercury, 504**  
 — extraction of by roasting ores  
 containing sulphide of mercury,  
 507  
 — — — — — the decomposition of  
 cinnabar by fluxes in closed  
 vessels, 524  
 — — — — — the old process in Idria,  
 511  
 — — — — — older method in the  
 Palatinate, 525  
 — — — — — new method in the  
 Palatinate, 528  
 — — — — — process in Almaden,  
 514  
 — — — — — at New Almaden,  
 in California, 517  
 — — — — — in cupola furnaces with  
 continuous operations, 518  
 — — — — — by the new pro-  
 cess in Idria, 518  
 — — — — — with interrupted  
 operations, 511  
 — — — — — in mounds, 509  
 — — — — — in reverberatory furnaces,  
 with continuous operations, 521  
 — — — — — method in New Almaden  
 and New Idria in California, 530  
 — native, 504  
 — production of throughout the  
 world, 531  
 — synopsis of processes for the ex-  
 traction of, 505  
**Miargyrite, 202**  
**Microbromite, 203**  
**Millerite, 555**  
**Mispickel, 205**
- NICKEL, 554**  
 — copper alloys, production of,  
 567  
 — deposits, production of, 566  
 — extraction of from speiss and ar-  
 senical ores, 576  
 — glance, antimonial, 554  
 — kies, 554  
 — metallic, production of, 567  
 — ochre, 554

Nickel ores, argentiferous, 209  
— concentration smelting of for the production of matt, 556  
— — — speiss, 562  
— — of Great Britain, 555  
— — principal, 554  
— — production of in the dry way, 569  
— — — — wet way, 570  
— — — by smelting intermediate products (matt, slag), 564  
— — — from matt, 579  
— — — refined copper and impure nickel, 582  
— purification of, 583  
— speiss glance, 554  
— — produced by the copper and lead smelting processes, concentration of, 563

## ORPIMENT, 604

— production of, 607  
Osm-iridium, separation of from gold, 661  
— — use of, 685

## PATERA'S process, 211

PATTINSON'S process, 192, 253  
— apparatus for, 260

## Platinum, 678

— alloys of, 685  
— extraction of in the dry way, 685  
— — — — wet way, 682  
— native, 678  
— ores, smelting of, 686  
— — — with galena, 688  
— pure, production of by combined wet and dry processes, 688  
— raw, analyses of, 682  
— sand, dressing of, 681

## PLATTNER'S process, 638

## Plumbiferous deposits, 107

## Precipitation process, 82

— — illustrations of, 98  
— — influences upon, 83  
— — mixture for, 88  
— — products of, 96

## Pyromorphite, 5

Pyrites, arsenical, 209  
— iron, argentiferous, 205

## QUARTATION process, 651

— — products of, 656

## RAW matt, smelting of, 138

realgar, 602  
— production of from arsenical pyrites and sulphur, 607  
— — — arsenious acid and sulphur, 607  
— — — iron and arsenical pyrites, 605

Reverberatory furnaces, comparisons of the dimensions of, 723  
Reverberatory process, 13  
Roasting reduction, precipitation process, 113

## SCOTCH hearth process, 69

Senarmontite, 540  
Silver, 201  
— — — antimonial, 202  
— — — mixed, 202  
— — — bismuth, 202  
— — — brightened, refining of, 302  
— — — — in crucibles, 314  
— — — — by the aid of blast, 305  
— — — — in cupelling furnaces, 304  
— — — — in the muffle, 305

— — — — — illustrations of, 306  
— — — — in reverberatory furnaces, 307

— — — — — with fixed hearth, 310

— — — — — movable hearth, 308

— chloride of, 203

— copper glance, 203

— Dürr ores, 207

— — — poor, smelting of, 222

— extraction of by means of hypsulphites, 391

— — — from rich lead by means of zinc, 315

— — — from sulphate of silver, 662

— — — in the wet way, 317

— — — with sulphuric acid, 395

— glance, 202

— iodide of, 203

— lixiviation and precipitation in the metallic state, 211

— ores and argentiferous products, treatment of in the wet way, (by solution and precipitation), 364

— — — dressing of, 205

— — — dark red, 203

— — — — white, 203

— — — ores, earthy, 128

— — — ore, light red, 202

— — — white, 203

— — — ores, principal, 201

— — — rich and moderately rich, smelting with lead compounds, 219

— — — fusing with raw lead in the cupelling process, 218

— — — smelting of in crucibles, 216

— — — — — former mode in Kongsberg, 217

— — — oxide and sulphate of, decomposition of by metallic lead, 251



Silver, native, 201  
 — — refining the, 217  
 — refined, 303  
 — sulphide of, decomposition of by metallic lead, 214  
 — — — — by oxide and sulphate of lead, 215  
 — synopsis of processes for the extraction of, 206  
 — tellurium, 202  
 Solfataras, 689, 691  
 Speiss, amalgamation of, 332  
 Stannine, 471  
 Stream tin, 473  
 Stream works, 473  
 Sulphides, metallic, 689  
 Sulphur, 689  
 — distillation of in closed vessels, 706  
 — extraction of from iron pyrites and pyritic ores, 714  
 — — — — in closed vessels, 714  
 — — — — in cupola furnaces, 706  
 — — — — from sulphurous earths, 706  
 — liquation of in apparatus, 707  
 — — in covered heaps, 708  
 — native, 689  
 — ores, principal, 689  
 — — very rich, smelting of in pans, products, artificial, 689  
 — purification of by distillation, 718  
 — — — by re-melting, 717  
 — — — in Germany, 721  
 — recovering of from alkali waste, 691  
 — — — method at Dieuze, 700  
 — — — HOFMANN'S process, 699  
 — — — MOND'S process, 692  
 — — — SCHAFFNER'S process, 699  
 — — — SPENCER'S method, 705  
 — Synopsis of processes for the extraction of, 690

**T**IN, 471  
 — crude, 486  
 — deposits, 490  
 — furnace ends, 490  
 — ore alluvial, 473  
 — — dust, 490  
 — — mechanical dressing of, 476  
 — — preparation of, 475  
 — ores, principal, 471  
 — — purification of from Wolfram, 484

Tin ores, purified, treatment of with acids, 483.  
 — — reduction of in cupola furnaces, 490  
 — — — — reverberatory furnaces, 499  
 — — roasted, washing the, 482  
 — — schlich, concentrated, roasting of, 476  
 — — slags, 489  
 — — — re-melting of, 496  
 — — — smelting the, 486  
 — — soft, burning of the, previous to dressing, 475  
 — production of in different countries, 503  
 — stone (Cassiterite), 471  
 — sulphide of, 471  
 — wood, 471

**U**RE'S furnace, 520, 525, 528

**V**OGL'S lead furnace, 78

**Z**IERVOGEL'S process, 378

zinc, 402  
 — blende, 205, 209, 404  
 — — roasting of, 412  
 — distillation of, 422  
 — dust, reduction of, 465  
 — extraction of in cupola and in reverberatory furnaces, 457  
 — hydrated carbonate of, 403  
 — extraction of (Belgian method), 428  
 — — — (Belgian-Silesian method), 448  
 — — — (Silesian method), 436  
 Zinciferous soot, 123  
 Zinc ores, 402  
 — — argentiferous, 205  
 — — calcination of in cupola furnaces, 410  
 — — — in reverberatory furnaces, 411  
 — — — mixing the, 421  
 — — — preparation of, 409  
 — — — red, 404  
 — — — roasted or calcined, dividing the, 420  
 — — — roasting and calcining the, 409  
 — — production of in Europe, 457  
 — — raw, re-melting and refining the, 460

[www.libtool.com.cn](http://www.libtool.com.cn)

[www.libtool.com.cn](http://www.libtool.com.cn)

MARCH, 1868.

WORKS ON  
[www.libtool.com.cn](http://www.libtool.com.cn)  
MEDICINE AND SURGERY,

AND IN

General Scientific Literature,

PUBLISHED BY

MESSRS. LONGMANS, GREEN, AND CO.,  
PATERNOSTER ROW, LONDON.

---

Anatomy, Surgery, and Physiology.

---

**A SYSTEM OF SURGERY,**

Theoretical and Practical, in Treatises by various Authors. Edited by T. HOLMES, M.A. Cantab., Surgeon and Lecturer on Surgery at St. George's Hospital, Surgeon to the Hospital for Sick Children.

VOL. I. GENERAL PATHOLOGY, 21s.

VOL. II. LOCAL INJURIES: GUN-SHOT WOUNDS, INJURIES OF THE HEAD, BACK, FACE, NECK, CHEST, ABDOMEN, PELVIS, OF THE UPPER AND LOWER EXTREMITIES, AND DISEASES OF THE EYE, 21s.

VOL. III. OPERATIVE SURGERY: DISEASES OF THE ORGANS OF CIRCULATION, LOCOMOTION, &c., 21s.

VOL. IV. DISEASES OF THE ORGANS OF DIGESTION, OF THE GENITO-URINARY SYSTEM, AND OF THE BREAST, THYROID GLAND, AND SKIN; with *Appendix* and *General Index*, 30s.

The Complete Work, in 4 vols. 8vo, 4l. 13s.

---

**A NATOMY, DESCRIPTIVE AND SURGICAL.**

By HENRY GRAY, F.R.S., late Lecturer on Anatomy at St. George's Hospital. With nearly 400 large Woodcuts from Original Drawings, from Dissections made by the Author and Dr. CARTER.

Fourth Edition, by T. HOLMES, M.A. Cantab., Assistant-Surgeon and Lecturer on Anatomy at St. George's Hospital. Royal 8vo, 28s.

**THE WORKS OF THE LATE SIR B. C. BRODIE,**  
BART., D.C.L., PRESIDENT OF THE ROYAL SOCIETY,  
&c.

With an Autobiography. Collected and Arranged by CHARLES HAWKINS,  
Fellow of the Royal College of Surgeons of England. 3 vols. 8vo, with  
Medallion and Facsimile, 48s.

**OUTLINES OF PHYSIOLOGY, HUMAN AND  
COMPARATIVE.**

By JOHN MARSHALL, F.R.S., Professor of Surgery in University  
College, London; Surgeon to the University College Hospital. With  
122 Woodcut Illustrations. 2 vols. crown 8vo, 32s.

**PHYSIOLOGICAL ANATOMY AND PHYSIO-  
LOGY OF MAN.**

By ROBERT B. TODD, M.D., and WILLIAM BOWMAN, F.R.S., of King's  
College. With numerous Illustrations. Vol. II. 8vo, 25s.

VOL. I. New Edition by Dr. LIONEL S. BEALE, F.R.S., in course of  
publication. PART I. 8vo, with 8 Plates (4 coloured), 7s. 6d.

**COMPARATIVE ANATOMY AND PHYSIO-  
LOGY OF THE VERTEBRATE ANIMALS.**

By RICHARD OWEN, F.R.S., Superintendent of the Nat. Hist. Depart-  
ments, British Museum. 3 vols. 8vo, with above 1,200 Woodcuts.

VOL. I. *Fishes and Reptiles*, with 452 Woodcuts, 21s.

VOL. II. *Warm-blooded Vertebrates*, with 406 Woodcuts, 21s.

VOL. III. completing the work, in the Spring.

**HISTOLOGICAL DEMONSTRATIONS;**

A Guide to the Microscopical Examination of the Animal Tissues in Health  
and Disease for the use of the Medical and Veterinary Professions. Being  
the substance of Lectures delivered by G. HARLEY, M.D. F.R.S. Prof. in  
Univ. Coll. Lond. and Physician to Univ. Coll. Hospital. Edited by  
G. T. BROWN, M.R.C.V.S. Post 8vo, with 224 Illustrations, price 12s.

Medical and Psychological Literature.

**COPLAND'S DICTIONARY OF PRACTICAL  
MEDICINE,**

Comprising Special Pathology, the Principles of Therapeutics, the Nature and Treatment of Diseases, Morbid Structures, and the Disorders especially Incidental to Climates, to Races, to Sex, and to the Epochs of Life ; with an Appendix of Approved Formulæ. The whole forming a Digest of Pathology and Therapeutics. Abridged from the larger work by the Author, assisted by J. C. COPLAND, M.R.C.S., and brought down to the present state of Medical Science. 8vo, price 36s.

**L**ECTURES ON THE PRINCIPLES AND  
PRACTICE OF PHYSIC.

By THOMAS WATSON, M.D. Physician-Extraordinary to the Queen. New Edition, preparing for publication.

**L**IFE OF SIR JOHN RICHARDSON, C.B.,  
LL.D, F.R.S., &c., sometime Inspector of Naval Hospitals and Fleets.

By the Rev. JOHN MCILRAITH, Minister of the English Reformed Church, Amsterdam. Fcp. 8vo, with Portrait, 5s.

**E**LEMENTS OF PSYCHOLOGY :

Containing the Analysis of the Intellectual Powers. By J. D. MORELL, M.A., LL.D. Post 8vo, 7s. 6d.

**A**N INTRODUCTION TO MENTAL PHILOSOPHY,  
On the Inductive Method. By the same Author. 8vo, 12s.

**T**HE HISTORY OF PHILOSOPHY FROM  
THALES TO COMTE.

By GEORGE HENRY LEWES. Third Edition, partly rewritten and greatly enlarged. 2 vols. 8vo, 30s.

**THE EMOTIONS AND THE WILL:**

Completing a Systematic Exposition of the Human Mind. By ALEXANDER BAIN, M.A., Professor of Logic in the University of Aberdeen. Second Edition, revised. 8vo, 15s.

**THE SENSES AND THE INTELLECT.**

By the same Author. Second Edition, with numerous Emendations. 8vo, 15s.

**ON THE STUDY OF CHARACTER:**

Including an Estimate of Phrenology. By the same Author. 8vo, 9s.

**MENTAL AND MORAL SCIENCE:**

A Compendium of Psychology and Ethics. By the same Author.

*[Just ready.]*

**AN EXAMINATION OF SIR W. HAMILTON'S PHILOSOPHY,**

And of the Principal Philosophical Questions discussed in his Writings. By JOHN STUART MILL, M.P. for Westminster. Third Edition. 8vo, 16s.

**A SYSTEM OF LOGIC, RATIOCINATIVE AND INDUCTIVE;**

Being a Connected View of the Principles of Evidence and the Methods of Scientific Investigation. By the same Author. Sixth Edition. 2 vols. 8vo, price 25s.

**Pathology and the Treatment of Disease.****LECTURES ON SURGICAL PATHOLOGY.**

Delivered at the Royal College of Surgeons of England. By J. PAGET, F.R.S., Surgeon-Extraordinary to H.M. the Queen. Revised and Edited by W. TURNER, M.B. New Edition, preparing for publication.

# A TREATISE ON THE CONTINUED FEVERS OF GREAT BRITAIN.

By C. MURCHISON, M.D., Senior Physician to the London Fever Hospital. 8vo, with Coloured Plates, 18s.

# CLINICAL LECTURES ON THE DISEASES OF THE LIVER.

By the same Author. 8vo, with Illustrations.

[Nearly ready.]

# CLINICAL RESEARCHES ON DISEASE IN INDIA.

By CHARLES MOREHEAD, M.D.; Surgeon to the Jamsetjee Jeejeebhoy Hospital. Second Edition, thoroughly revised. 8vo, 21s.

# ST. BARTHOLOMEW'S HOSPITAL REPORTS.

Edited by Dr. EDWARDS and Mr. CALLENDER. With Illustrations in Lithography and Woodcuts. Vols. I, II, and III. 8vo, 7s. 6d. each.

# ON EPIDEMIC DIARRHŒA AND CHOLERA;

Their Pathology and Treatment: with a Record of Cases. By GEORGE JOHNSON, M.D., &c., Physician to King's College Hospital. Post 8vo, price 7s. 6d.

# CLINICAL ILLUSTRATIONS OF VARIOUS FORMS OF CANCER,

And of other Diseases likely to be mistaken for them; with especial reference to their Surgical Treatment. By OLIVER PEMBERTON, Surgeon to the General Hospital, Birmingham. Imp. 4to, with 12 Plates, 1l. 11s. 6d. Plain, or 2l. 2s. coloured.

# RODENT CANCER;

With Photographic and other Illustrations of its Nature and Treatment. By CHARLES H. MOORE, F.R.C.S., Vice-President of the Royal Med. and Chir. Soc. of Lond., Surgeon to the Middlesex Hospital and to St. Luke's Hospital for Lunatics. Post 8vo. 6s.



## ON CANCER: ITS ALLIES AND COUNTERFEITS.

By WEEDEN COOKE, Surgeon to the Cancer Hospital and to the Royal Free Hospital. With 12 Coloured Plates. 8vo, 12s. 6d.

---

## CLINICAL OBSERVATIONS ON DISEASES OF THE HEART AND THORACIC AORTA.

By PEYTON BLAKISTON, M.D., F.R.S. Post 8vo, 6s. 6d.

---

## TUBERCLE, THE NATURE AND AFFINITIES OF.

Being the Gulstonian Lectures for 1867. By REGINALD SOUTHEY, M.D., Assistant-Physician to St. Bartholomew's Hospital. 8vo. 5s.

---

## THE ELEMENTS OF PROGNOSIS IN CONSUMPTION;

With Indications for the Prevention and Treatment. By JAMES EDWARD POLLOCK, M.D., &c. Physician to the Hospital for Consumption and Diseases of the Chest, Brompton. 8vo, with 4 Illustrations, 14s.

---

## HYSTERIA;

Remote Causes of Disease in General; Treatment of Disease by Tonic Agency; Local or Surgical Forms of Hysteria, &c. Six Lectures delivered to the Students of St. Bartholomew's Hospital. By F. C. SKEY, F.R.S. &c. Consulting Surgeon to St. Bartholomew's Hospital. Second Edition. Crown 8vo, 5s.

---

## ON THE PATHOLOGY AND TREATMENT OF ALBUMINURIA.

By W. H. DICKINSON, M.D. Cantab. Fellow of the College of Physicians, Assistant Physician to St. George's Hospital and to the Hospital for Sick Children. With 10 Plates (5 coloured) and 13 Woodcuts. 8vo, 14s.

---

## ON THE SURGICAL DISEASES OF THE TEETH AND CONTIGUOUS STRUCTURES, WITH THEIR TREATMENT.

By S. JAMES A. SALTER, M.B., F.R.S. Dental Surgeon to Guy's Hospital. [Nearly ready.]

## **INJURIES OF THE EYE, ORBIT, AND LIDS ;**

Their Immediate and Remote Effects. By GEORGE LAWSON, 1  
Eng. Assistant Surgeon to the Royal London Ophthalmic Hospita  
fields, and to the Middlesex Hospital. 8vo, with 92 Woodcuts, 1:

[www.libtool.com.cn](http://www.libtool.com.cn)

## **A PRACTICAL TREATISE ON THE DISE. OF THE EYE.**

By WILLIAM MACKENZIE, M.D. Fourth Edition, revised and en  
8vo, with Plates and Woodcuts, 30s.

## **ON SPINAL WEAKNESS AND SPINAL C VATURES ; their Early Recognition and Treatment.**

By W. J. LITTLE, M.D., &c., Founder and formerly Senior M  
Officer of the Royal Orthopædic Hospital. 8vo, with 10 Woodcuts,

## **Diseases of Women and Children, and Popular Medical Works.**

## **THE DIAGNOSIS AND TREATMENT DISEASES OF WOMEN, INCLUDING THE DIAGNO OF PREGNANCY.**

By GRAILY HEWITT, M.D., Professor of Midwifery and Disease  
Women, University College, and Obstetric Physician to the Hosp  
Vice-President of the Obstetrical Society of London. Second Edit  
revised, and for the most part re-written ; with 116 Illustrations engr  
on Wood. 8vo, 24s.

## **EXPOSITION OF THE SIGNS AND SYM. TOMS OF PREGNANCY :**

With some other Papers on subjects connected with Midwifery. By W.  
MONTGOMERY, M.A., M.D., M.R.I.A. 8vo, with Portrait, 6 colour  
Plates comprising 25 Figures, and 48 Woodcuts, 25s.

## HINTS TO MOTHERS FOR THE MANAGEMENT OF THEIR HEALTH DURING PREGNANCY AND IN THE LYING-IN ROOM :

With Hints on Nursing, &c. By THOMAS BULL, M.D. New Edition, revised and enlarged. Fcap. 5s.

## THE MATERNAL MANAGEMENT OF CHILDREN IN HEALTH AND DISEASE.

By the same Author. New Edition, revised and enlarged. Fcap. 5s.

## THE SURGICAL DISEASES OF INFANCY AND CHILDHOOD.

By T. HOLMES, Surgeon to the Hospital for Sick Children, Surgeon and Lecturer on Surgery at St. George's Hospital. 1 vol. 8vo, with numerous Illustrations. [Nearly ready.]

## LECTURES ON THE DISEASES OF INFANCY AND CHILDHOOD.

By CHARLES WEST, M.D., &c., Physician to the Hospital for Sick Children. Fifth Edition, revised and enlarged. 8vo, 16s.

## ILLUSTRATIONS OF CHILDREN'S DISEASES.

By the same Author. [Preparing for publication.]

## HOW TO NURSE SICK CHILDREN ;

Containing Directions which may be found of service to all who have the Charge of the Young. By the same Author. Fourth Edition. Fcap. 8vo, 1s. 6d.

## THE PHILOSOPHY OF HEALTH ;

Or, an Exposition of the Physiological and Sanitary Conditions conducive to Human Longevity and Happiness. By SOUTHWOOD SMITH, M.D. Eleventh Edition, with 113 Figures engraved on Wood. 8vo, 7s. 6d.

## A MANUAL OF THE DOMESTIC PRACTICE OF MEDICINE.

By W. B. KESTIVEN, Fellow of the Royal College of Surgeons of England, &c. Third Edition, thoroughly revised ; with many Additions, and the *omission* of such topics as were found in practice to render the first edition less strictly adapted for *domestic* use. Fcap. 8vo, 5s.

## GYMNASTS AND GYMNASTICS.

By JOHN H. HOWARD. Second Edition, revised and enlarged, with various Selections from the best Authors, containing 445 Exercises; and illustrated with 135 Engravings, including the Most Recent Improvements in the different Apparatus now used in the various Clubs, &c. Crown 8vo, 10s. 6d.

---

## NOTES ON HOSPITALS.

By FLORENCE NIGHTINGALE. Third Edition, enlarged, and for the most part re-written. Post 4to, with 13 Plans, 18s.

---

## *Materia Medica and Dietetics.*

---

## THOMSON'S CONSPECTUS OF THE BRITISH PHARMACOPEIA.

Twenty-fifth Edition, corrected. By EDMUND LLOYD BIRKETT, M.D., &c., Physician to the City of London Hospital for Diseases of the Chest. 18mo. [Nearly ready.]

---

## MANUAL OF MATERIA MEDICA AND THERAPEUTICS:

Being an Abridgment of the late Dr. PEREIRA'S Elements of Materia Medica, arranged in conformity with the British Pharmacopœia, and adapted to the use of Medical Practitioners, Chemists and Druggists, Medical and Pharmaceutical Students, &c. By F. J. FARRE, M.D. &c.; assisted by R. BENTLEY, M.R.C.S., and R. WARINGTON, F.R.S. 8vo, with 90 Woodcuts, 21s.

---

## ON FOOD AND ITS DIGESTION:

Being an Introduction to Dietetics. By W. BRINTON, M.D., late Physician to St. Thomas's Hospital. 8vo, with 48 Woodcuts, 12s.

---

## ACTON'S MODERN COOKERY FOR PRIVATE FAMILIES,

Reduced to a System of Easy Practice in a Series of carefully tested Receipts, in which the Principles of Baron Liebig and other eminent writers have been as much as possible applied and explained. Newly revised and enlarged Edition, with additional Plates and Woodcuts. Fcap. 8vo, price 6s.

## Chemistry.

[www.libtool.com.cn](http://www.libtool.com.cn)

### DICTIONARY OF CHEMISTRY AND THE ALLIED BRANCHES OF OTHER SCIENCES.

By HENRY WATTS, F.C.S., assisted by eminent Contributors. 4 vols. 8vo. In course of publication periodically in Parts. VOL. I. 31s. 6d., VOL. II. 26s., VOL. III. price 31s. 6d., and Vol. IV., price 24s. are now ready.

### ELEMENTS OF CHEMISTRY,

Theoretical and Practical. By WILLIAM ALLEN MILLER, M.D., LL.D., F.R.S., Professor of Chemistry, King's College, London. Revised Edition, complete in 3 vols. 8vo, 3l. May be had separately :—

PART I.—CHEMICAL PHYSICS, 4th Edition, 15s.

„ II.—INORGANIC CHEMISTRY, 4th Edition, 21s.

„ III.—ORGANIC CHEMISTRY, 3d Edition, 24s.

### A MANUAL OF CHEMISTRY,

Descriptive and Theoretical. By WILLIAM ODLING, M.B., F.R.S., Fellow of the Royal College of Physicians, Secretary to the Chemical Society, and Lecturer on Chemistry at St. Bartholomew's Hospital. PART I. 8vo, 9s. sewed. PART II. *Nearly ready.*

### A COURSE OF PRACTICAL CHEMISTRY,

Arranged for the use of Medical Students, with express reference to the Three Months' Summer Practice. By the same Author. Second Edition, illustrated with 70 new Woodcuts. Crown 8vo, 7s. 6d.

### LECTURES ON ANIMAL CHEMISTRY,

Delivered at the Royal College of Physicians. By the same Author. Crown 8vo, 4s. 6d.

### HANDBOOK OF CHEMICAL ANALYSIS,

Adapted to the Unitary System of Notation. By F. T. CONINGTON, M.A., F.C.S. Post 8vo, 7s. 6d.

### CONINGTON'S TABLES FOR QUALITATIVE ANALYSIS. Designed as a Companion to the above. 2s. 6d.

**CHEMICAL NOTES FOR THE LECTURE ROOM—ON HEAT, LAWS OF CHEMICAL COMBINATION, AND CHEMISTRY OF THE NON-METALLIC ELEMENTS.**

By THOMAS WOOD, Ph. D., F.C.S., &c., Chemical Lecturer at the Brighton College. Second Edition. Crown 8vo, 3s. 6d.

**Science and Natural History.**

**BRANDE'S DICTIONARY OF SCIENCE, LITERATURE AND ART;**

Comprising the Definitions and Derivations of the Scientific Terms in general use, together with the History and Descriptions of the Scientific Principles of nearly every branch of Human Knowledge. Fourth Edition, reconstructed and extended under the Joint-Editorship of the late Author and the Rev. GEORGE W. COX, M.A.; assisted by Contributors of eminent Scientific and Literary Acquirements. 3 vols. medium 8vo, 63s.

**URE'S DICTIONARY OF ARTS, MANUFACTURES, AND MINES;**

Containing a clear Exposition of their Principles and Practice. Sixth Edition, chiefly rewritten and greatly enlarged by ROBERT HUNT, F.R.S., Keeper of Mining Records, assisted by numerous Contributors eminent in Science and the Arts, and familiar with Manufactures. With above 2000 Woodcuts. 3 vols. medium 8vo, 4l. 14s. 6d.

**ELEMENTARY TREATISE ON PHYSICS,**

Experimental and Applied, for the use of Colleges and Schools. Translated and edited from GANOT'S *Éléments de Physique* (with the Author's sanction) by E. ATKINSON, Ph.D. F.C.S. Professor of Experimental Science, Royal Military College, Sandhurst. New Edition, with a Plate and 620 Woodcuts. Post 8vo, 15s.

## ARNOTT'S ELEMENTS OF PHYSICS OR NATURAL PHILOSOPHY.

Written for General Use in Plain or Non-technical Language. Sixth Edition, thoroughly revised by the Author; and containing in the SECOND PART the new completing chapters on Electricity and Astronomy, with an Outline of Popular Mathematics. 8vo, in TWO PARTS, which may be had separately, price 10s. 6d. each.

## THE CORRELATION OF PHYSICAL FORCES.

By W. R. GROVE, Q.C., M.A., V.P.R.S. New Edition, being the Fifth, followed by a Discourse on Continuity. 8vo, 10s. 6d. The Discourse on Continuity may be had separately, price 2s. 6d.

## HEAT A MODE OF MOTION.

By JOHN TYNDALL, LL.D., F.R.S., Professor of Natural Philosophy in the Royal Institution of Great Britain, and in the Royal School of Mines. Third Edition, with Additions and Illustrations. Crown 8vo, with Plate and 108 Woodcuts, 10s. 6d.

## SOUND;

A Course of Eight Lectures delivered at the Royal Institution of Great Britain. By the same Author. With a Portrait of M. CHLADNI, and 169 Woodcuts. Crown 8vo. 9s.

## FARADAY AS A DISCOVERER: A MEMOIR.

By the same Author. With Two Portraits. Crown 8vo, 6s.

## LIGHT; ITS INFLUENCE ON LIFE AND HEALTH.

By FORBES WINSLOW, M.D., D.C.L. Oxon. (Hon.) Fcp. 8vo, 6s.

## AN ESSAY ON DEW, AND SEVERAL AP- PEARANCES CONNECTED WITH IT.

By W. C. WELLS. Edited, with Annotations, by L. P. CASELLA, F.R.A.S., and an Appendix by R. STRACHAN, F.M.S. 8vo, 5s.

## OUTLINES OF ASTRONOMY.

By Sir JOHN F. W. HERSCHEL, Bart., K.H., &c., Member of the Institute of France. Ninth Edition, with Corrections. 8vo, with 9 Plates, 18s.

## CELESTIAL OBJECTS FOR COMMON LESCEPES.

By the Rev. T. W. WEBB, M.A., F.R.A.S., Incumbent of Herefordshire. Revised Edition, with more numerous Illustrations [Near!]

## A TREATISE ON ELECTRICITY,

[www.libtool.com.cn](http://www.libtool.com.cn)  
In Theory and Practice. By A. DE LA RIVE, late Professor Academy of Geneva. Translated for the Author by C. V. W. F.R.S. 3 vols. 8vo, with numerous Woodcuts, 3*l.* 13*s.*

## DOVE'S LAW OF STORMS,

Considered in connexion with the ordinary Movements of the Atmos Translated by R. H. SCOTT, M.A., T.C.D. 8vo, 10*s.* 6*d.*

## MANUAL OF GEOLOGY.

By SAMUEL HAUGHTON, M.D., F.R.S., Fellow of Trin. Coll Professor of Geology in the Univ. of Dublin. Second Edition, with Figures engraved on Wood. Fcap. 8vo, 7*s.* 6*d.*

## A GUIDE TO GEOLOGY.

By JOHN PHILLIPS, M.A., LL.D., F.G.S., Professor of Geology in University of Oxford, &c. Fifth Edition, revised and corrected. F with 4 Plates and 53 Diagrams, 4*s.*

## THE PRIMITIVE INHABITANTS OF SCANDINAVIA :

Containing a description of the Implements, Dwellings, Tombs, and Mode of Living of the Savages in the North of Europe during the Stone Age. By SVEN NILSSON. Third Edition, revised by the Author; with Introduction by Sir JOHN LUBBOCK, Bart., F.R.S. 8vo, with 16 Plate Figures of Remains, 18*s.*

## A GLOSSARY OF MINERALOGY.

By HENRY WILLIAM BRISTOW, F.G.S., of the Geological Survey Great Britain. Crown 8vo, with 486 Figures on Wood, 6*s.*

## ROCKS CLASSIFIED AND DESCRIBED ;

A Treatise on Lithology. By BERNHARD VON COTTA. An English Edition by PHILIP HENRY LAWRENCE (with English, German, and French Synonymes), revised by the Author. Post 8vo, 14*s.*



## A PRACTICAL TREATISE ON METALLURGY,

Elaborated after the last German Edition of KERL's *Metallurgy*, for use in Great Britain and the English Colonies. By WILLIAM CROOKES, F.R.S., &c., and ERNST ROHRIG, Ph.D., B.D. 2 vols. 8vo, with numerous Illustrations. [In the press.]

## MANUAL OF PRACTICAL ASSAYING,

For the use of Metallurgists, Captains of Mines, and Assayers in general; with copious Tables for Ascertaining in Assays of Gold and Silver the Precise Amount in Ounces, Pennyweights, and Grains of Noble Metal contained in One Ton of Ore from a Given Quantity. By JOHN MITCHELL, F.C.S. Second Edition [1854]; with 360 Woodcuts. 8vo. 21s.

## MANUAL OF THE METALLOIDS.

By JAMES APJOHN, M.D. Edited by the Rev. J. A. GALBRAITH, M.A. and the Rev. S. HAUGHTON, M.D., F.R.S. Second Edition, revised. Fcap. 8vo, with 38 Woodcuts, 7s. 6d.

## MANUAL OF CORALS AND SEA JELLIES

(*Calenterata*.) By J. R. GREENE, B.A. Edited by J. A. GALBRAITH, M.A. and S. HAUGHTON, M.D. Fcap. 8vo, with 39 Woodcuts, 5s.

## MANUAL OF SPONGES AND ANIMALCULÆ

(*Protozoa*); with a General Introduction on the Principles of Zoology. By the same Author and Editors. Fcap. 8vo, with 16 Woodcuts, 2s.

## TAPEWORMS AND THREADWORMS

(HUMAN ENTOZOA);

Their Sources, Nature, and Treatment. By T. S. COBBOLD, M.D., F.R.S., F.L.S. Lecturer at the Middlesex Hospital. Second Edition, with 15 Woodcuts. Fcp. 8vo, 3s. 6d.

## THE TREASURY OF BOTANY, OR POPULAR DICTIONARY OF THE VEGETABLE KINGDOM;

With which is incorporated a Glossary of Botanical Terms. Edited by J. LINDLEY, M.D., F.R.S., and T. MOORE, F.L.S., assisted by numerous Contributors. With 20 Steel Plates, and numerous Woodcuts from Original Designs by W. H. FITCH. 2 Parts, fcap. 8vo, 20s.

## THE BRITISH FLORA :

Comprising the Phanogamous or Flowering Plants and the Ferns. Eighth Edition, revised and enlarged, with many figures illustrative of the Umbelliferous Plants, the Composite Plants, the Grasses, and the Ferns. By the late Sir W. J. HOOKER, F.R.A.S., F.L.S., and G. A. WALKER-ARNOTT, F.L.S., Regius Professor of Botany in the Univ. of Glasgow. 12mo, with 12 Plates, 14s. ; with Coloured Plates, 21s.

## LOUDON'S ENCYCLOPÆDIA OF PLANTS :

Comprising the Specific Character, Description, Culture, History, Application in the Arts, and every other desirable particular respecting all the plants indigenous to, cultivated in, or introduced into, Britain. Corrected by Mrs. LOUDON, assisted by GEORGE DON, F.L.S., and DAVID WOOSTER. 8vo, with above 12,000 Woodcuts, price 42s.

## HOMES WITHOUT HANDS :

A description of the Habitations of Animals, classed according to their Principle of Construction. By the Rev. J. G. WOOD, M.A., F.L.S., with about 140 Vignettes on Wood (20 full size of page). Second Edition. 8vo, price 21s.

## BIBLE ANIMALS ;

Being an Account of the various Birds, Beasts, Fishes, and other Animals mentioned in the Holy Scriptures. By the same Author. Copiously Illustrated with Original Designs, made under the Author's superintendence, and engraved on Wood. In course of publication monthly, to be completed in 20 Parts, price 1s. each, forming One Volume, uniform with "Homes without Hands."

## THE HARMONIES OF NATURE AND UNITY OF CREATION.

By Dr. G. HARTWIG. 8vo, with numerous Illustrations, 18s.

## THE SEA AND ITS LIVING WONDERS.

By the same Author. Third Edition, enlarged. 8vo, with many Illustrations, 21s.

## THE TROPICAL WORLD.

By the same Author, with 8 Chromoxylographs and 172 Woodcuts. 8vo, price 21s.

## THE POLAR WORLD :

A Popular Account of Nature and Man in the Arctic and Antarctic Regions. By the same Author. 8vo, with numerous Illustrations.

[*Nearly ready.*]

# Index.

<p>Acton's Cookery . . . . . 9</p> <p>Apjohn's Manual of the Metalloids. 14</p> <p>Arnott's Elements of Physics . . 12</p> <p>Bain on the Emotions and Will . . 4</p> <p>— on Mental and Moral Science. 4</p> <p>— on the Senses and Intellect . . 4</p> <p>— on the Study of Character . . . 4</p> <p>Blakiston on Diseases of the Heart 6</p> <p>Brande's Dictionary of Science, Literature, and Art . . . . . 11</p> <p>Brinton on Food and Digestion . . 9</p> <p>Bristow's Glossary of Mineralogy . 13</p> <p>Brodie's (Sir B. C.) Works . . . . 2</p> <p>Bull's Hints to Mothers . . . . . 8</p> <p>— Maternal Management of Children . . . . . 8</p> <p>Cobbold on Tapeworms . . . . . 14</p> <p>Conington's Handbook of Chemical Analysis . . . . . 10</p> <p>Cooke on Cancer . . . . . 6</p> <p>Copland's Dictionary of Practical Medicine . . . . . 3</p> <p>Crookes and Rohrig's Metallurgy . 14</p> <p>De La Rive's Treatise on Electricity 13</p> <p>Dickinson on Albuminuria . . . . . 6</p> <p>Dove's Law of Storms . . . . . 13</p> <p>Ganot's Physics . . . . . 11</p> <p>Gray's Anatomy . . . . . 1</p> <p>Greem on Diet of Children . . . . . 10</p> <p>Greene's Corals and Sea Jellies . . 14</p> <p>— Sponges and Animalculæ . . . . 14</p> <p>Grove on Correlation of Physical Forces . . . . . 12</p> <p>Harley and Brown's Histological Demonstrations . . . . . 2</p> <p>Haughton's Manual of Geology . . . 13</p> <p>Hartwig's Harmonies of Nature . . 15</p> <p>— Polar World . . . . . 15</p> <p>— Sea and its Living Wonders . . . . . 15</p> <p>— Tropical World . . . . . 15</p> <p>Herschel's Outlines of Astronomy . 12</p> <p>Hewitt on the Diseases of Women . 6</p> <p>Holmes's Surgery . . . . . 1</p> <p>— Surgical Diseases of Infancy . . 8</p> <p>Hooker and Walker-Arnott's British Flora . . . . . 15</p> <p>Howard's Gymnasts and Gymnastics . . . . . 9</p> <p>Johnson on Cholera and Diarrhoea 5</p> <p>Kesteven's Domestic Medicine . . . 8</p> <p>Lawson on Injuries of the Eye . . . 7</p> <p>Lawrence on Rocks . . . . . 13</p> <p>Lewes's History of Philosophy . . . 3</p> <p>Life of Sir John Richardson . . . . 3</p> <p>Lindley's Treasury of Botany . . . . 14</p>	<p>Little on Spinal Weakness . . . . . 7</p> <p>Loudon's Encyclopædia of Plants . . 15</p> <p>Mackenzie on Diseases of the Eye . 7</p> <p>Marshall's Outlines of Physiology . 2</p> <p>Mill's Hamilton's Philosophy . . . . 4</p> <p>— System of Logic . . . . . 4</p> <p>Miller's Elements of Chemistry . . 10</p> <p>Mitchell's Assaying . . . . . 14</p> <p>Montgomery on Pregnancy . . . . . 6</p> <p>Moore on Rodent Cancer . . . . . 5</p> <p>Morehead on Disease in India . . . . 5</p> <p>Morell's Elements of Psychology . . 3</p> <p>— Mental Philosophy . . . . . 3</p> <p>Murchison on Continued Fevers . . . 5</p> <p>— on Diseases of the Liver . . . . 5</p> <p>Nightingale's Notes on Hospitals . . 9</p> <p>Nilsson's Stone Age in Scandinavia 13</p> <p>Odling's Animal Chemistry . . . . . 10</p> <p>— Course of Practical Chemistry . . . . . 10</p> <p>— Manual of Chemistry . . . . . 10</p> <p>Owen's Comparative Anatomy and Physiology of Vertebrate Animals . . . . . 2</p> <p>Paget's Lectures on Surgical Pathology . . . . . 4</p> <p>Pemberton's Illustrations of Cancer 5</p> <p>Pereira's Manual of Materia Medica 9</p> <p>Phillips' Guide to Geology . . . . . 13</p> <p>Pollock on Consumption . . . . . 6</p> <p>St. Bartholomew's Hospital Reports 5</p> <p>Salter on Diseases of the Teeth . . . 6</p> <p>Skey on Hysteria . . . . . 6</p> <p>Smith's Philosophy of Health . . . . . 8</p> <p>Southey on Tubercle . . . . . 6</p> <p>Thomson's Conspectus, by Birkett . . 9</p> <p>Todd and Bowman's Anatomy and Physiology of Man . . . . . 2</p> <p>Tyndall's Lectures on Sound . . . . . 12</p> <p>— — — — — Heat . . . . . 12</p> <p>— — — — — Memoir of Faraday . . . . . 12</p> <p>Ure's Dictionary of Arts, Manufactures, and Mines . . . . . 11</p> <p>Watson's Principles and Practice of Physic . . . . . 3</p> <p>Watts's Dictionary of Chemistry . . 10</p> <p>Webb's Celestial Objects for Common Telescopes . . . . . 13</p> <p>Wells on Dew . . . . . 12</p> <p>West on the Diseases of Children . . 8</p> <p>— Illustrations of ditto . . . . . 8</p> <p>— How to Nurse Sick Children . . . 8</p> <p>Winslow on Light . . . . . 12</p> <p>Wood's Chemical Notes . . . . . 11</p> <p>— Bible Animals . . . . . 15</p> <p>— Homes without Hands . . . . . 15</p>
--	--

# GENERAL LIST OF WORKS

www.libtool.com.cn

PUBLISHED BY

Messrs. LONGMANS, GREEN, READER, and DYER.

ARTS, MANUFACTURES, &c.....	12	MISCELLANEOUS and POPULAR META- PHYSICAL WORKS.....	6
ASTRONOMY, METEOROLOGY, POPULAR GEOGRAPHY, &c.....	7	NATURAL HISTORY and POPULAR SCIENCE.....	7
BIOGRAPHY AND MEMOIRS.....	3	POETRY and THE DRAMA.....	18
CHEMISTRY, MEDICINE, SURGERY, and the ALLIED SCIENCES.....	10	RELIGIOUS AND MORAL WORKS.....	14
COMMERCE, NAVIGATION, and MERCAN- TILE AFFAIRS.....	19	RURAL SPORTS, &c.....	19
CRITICISM, PHILOLOGY, &c.....	4	TRAVELS, VOYAGES, &c.....	16
FINE ARTS and ILLUSTRATED EDITIONS	11	WORKS OF FICTION.....	17
HISTORICAL WORKS.....	1	WORKS OF UTILITY and GENERAL INFORMATION.....	20
INDEX.....	21-24		

## *Historical Works.*

**Lord Macaulay's Works.** Complete and uniform Library Edition. Edited by his Sister, Lady TREVELYAN. 8 vols. 8vo. with Portrait, price £5 5s. cloth, or £8 8s. bound in tree-calf by Rivière.

**The History of England from the Fall of Wolsey to the Death of Elizabeth.** By JAMES ANTHONY FROUDE, M.A. late Fellow of Exeter College, Oxford. VOLS. I. to X. in 8vo. price £7 2s. cloth.

VOLS. I. to IV. the Reign of Henry VIII. Third Edition, 54s.

VOLS. V. and VI. the Reigns of Edward VI. and Mary. Third Edition, 28s.

VOLS. VII. & VIII. the Reign of Elizabeth, VOLS. I. & II. Fourth Edition, 28s.

VOLS. IX. and X. the Reign of Elizabeth. VOLS. III. and IV. 32s.

**The History of England from the Accession of James II.** By Lord MACAULAY.

LIBRARY EDITION, 5 vols. 8vo. £4.

CABINET EDITION, 8 vols. post 8vo. 48s.

PEOPLE'S EDITION, 4 vols. crown 8vo. 16s.

**Revolutions in English History.** By ROBERT VAUGHAN, D.D. 3 vols. 8vo. 30s.

**An Essay on the History of the English Government and Constitution, from the Reign of Henry VII. to the Present Time.** By JOHN EARL RUSSELL. Fourth Edition, revised. Crown 8vo. 6s.

**On Parliamentary Government in England: its Origin, Development, and Practical Operation.** By ALPHEUS TODD, Librarian of the Legislative Assembly of Canada. In two volumes. Vol. I. 8vo. 16s.

**The History of England during the Reign of George the Third.** By the Right Hon. W. N. MASSEY. Cabinet Edition, 4 vols. post 8vo. 24s.

**The Constitutional History of England, since the Accession of George III. 1760-1860.** By Sir THOMAS ERSKINE MAY, K.C.B. Second Edit. 2 vols. 8vo. 33s.

**Brodie's Constitutional History of the British Empire from the Accession of Charles I. to the Restoration.** Second Edition. 3 vols. 8vo. 36s.

**Historical Studies.** I. On Precursors of the French Revolution; II. Studies from the History of the Seventeenth Century; III. Leisure Hours of a Tourist. By HERMAN MERIVALE, M.A. 8vo. 12s. 6d.

- The Government of England: its Structure and its Development.** By WILLIAM EDWARD HEARN, LL.D. Professor of History and Political Economy in the University of Melbourne. 8vo. 14s.
- Plutology**, or, the Theory of the Efforts to Satisfy Human Wants. By the same Author. 8vo. 14s.
- Lectures on the History of England.** By WILLIAM LONGMAN. VOL. I. from the Earliest Times to the Death of King Edward II. with 6 Maps, a coloured Plate, and 58 Woodcuts. 8vo. 15s.
- History of Civilization in England and France, Spain and Scotland.** By HENRY THOMAS BUCKLE. Fifth Edition of the entire work, with a complete Index. 3 vols. crown 8vo. 24s.
- The History of India, from the Earliest Period to the close of Lord Dalhousie's Administration.** By JOHN CLARK MARSHMAN. 8 vols. crown 8vo. 22s. 6d.
- History of the French in India, from the Founding of Pondichery in 1674 to its Capture in 1761.** By Major G. B. MALLESON, Bengal Staff Corps, some time in political charge of the Princes of Mysore and the King of Oudh. 8vo. 16s.
- Democracy in America.** By ALEXIS DE TOCQUEVILLE. Translated by HENRY REEVE, with an Introductory Notice by the Translator. 2 vols. 8vo. 21s.
- The Spanish Conquest in America, and its Relation to the History of Slavery and to the Government of Colonies.** By ARTHUR HELPS. 4 vols. 8vo. £3. Vols. I. & II. 28s. Vols. III. & IV. 16s. each.
- The Oxford Reformers of 1498; being a History of the Fellow-work of John Colet, Erasmus, and Thomas More.** By FREDERIC SEEBOHM. 8vo. 12s.
- History of the Reformation in Europe in the Time of Calvin.** By J. H. MERLE D'AUBIGNÉ, D.D. Vols. I. and II. 8vo. 28s. Vol. III. 12s. and Vol. IV. price 16s. Vol. V. in the press.
- Library History of France, in 5 vols. 8vo.** By EYRE EVANS CROWE. Vol. I. 14s. Vol. II. 15s. Vol. III. 18s. Vol. IV. 18s. Vol. V. just ready.
- Lectures on the History of France.** By the late Sir JAMES STEPHEN, LL.D. 2 vols. 8vo. 24s.
- The History of Greece.** By C. THIBLWALL, D.D. Lord Bishop of St. David's. 8 vols. fcp. 28s.
- The Tale of the Great Persian War, from the Histories of Herodotus.** By GEORGE W. COX, M.A. late Scholar of Trin. Coll. Oxon. Fcp. 7s. 6d.
- Greek History from Themistocles to Alexander, in a Series of Lives from Plutarch.** Revised and arranged by A. H. CLOUGH. Fcp. with 44 Woodcuts, 6s.
- Critical History of the Language and Literature of Ancient Greece.** By WILLIAM MURK, of Caldwell. 5 vols. 8vo. £3 9s.
- History of the Literature of Ancient Greece.** By Professor K. O. MÜLLER. Translated by the Right Hon. Sir GEORGE CORNEWALL LEWIS, Bart. and by J. W. DONALDSON, D.D. 8 vols. 8vo. 86s.
- History of the City of Rome from its Foundation to the Sixteenth Century of the Christian Era.** By THOMAS H. DYER, LL.D. 8vo. with 2 Maps, 15s.
- History of the Romans under the Empire.** By C. MERIVALE, LL.D. Chaplain to the Speaker. 8 vols. post 8vo. price 48s.
- The Fall of the Roman Republic: a Short History of the Last Century of the Commonwealth.** By the same Author. 12mo. 7s. 6d.
- The Conversion of the Roman Empire; the Boyle Lectures for the year 1864, delivered at the Chapel Royal, Whitehall.** By the same. 2nd Edition. 8vo. 8s. 6d.
- The Conversion of the Northern Nations; the Boyle Lectures for 1865.** By the same Author. 8vo. 8s. 6d.
- Critical and Historical Essays** contributed to the *Edinburgh Review*. By the Right Hon. Lord MACAULAY.  
LIBRARY EDITION, 3 vols. 8vo. 86s.  
TRAVELLER'S EDITION, in 1 vol. 21s.  
CABINET EDITION, 4 vols. 24s.  
POCKET EDITION, 8 vols. fcp. 21s.  
PEOPLE'S EDITION, 2 vols. crown 8vo. 8s.
- The Papal Drama: an Historical Essay, wherein the Story of the Popedom of Rome is narrated from its Origin to the Present Time.** By THOMAS H. GILL. 8vo. price 12s.

**History of the Rise and Influence of the Spirit of Rationalism in Europe.** By W. E. H. LECKY, M.A. Third Edition. 2 vols. 8vo. 25s.

**God in History; Or, the Progress of Man's Faith in a Moral Order of the World.** By the late Baron BUNSEN. Translated from the German by SUSANNA WINKWORTH; with a Preface by ARTHUR PENRHYN STANLEY, D.D. Dean of Westminster, 3 vols. 8vo. [*Nearly ready.*]

**The History of Philosophy, from Thales to Comte.** By GEORGE HENRY LEWES. Third Edition, rewritten and enlarged. 2 vols. 8vo. 80s.

**Egypt's Place in Universal History; an Historical Investigation.** By BARON BUNSEN, D.C.L. Translated by C. H. COTTRELL, M.A., with Additions by S. BIRCH, LL.D. 5 vols. 8vo. £8 14s. 6d.

**Maunder's Historical Treasury; comprising a General Introductory Outline of Universal History, and a Series of Separate Histories.** Fcp. 10s.

**Historical and Chronological Encyclopedia, presenting in a brief and convenient form Chronological Notices of all the Great Events of Universal History.** By B. B. WOODWARD, F.S.A. Librarian to the Queen. [*In the press.*]

**History of the Christian Church, from the Ascension of Christ to the Conversion of Constantine.** By E. BURTON, D.D. late Regius Prof. of Divinity in the University of Oxford. Fcp. 8s. 6d.

**Sketch of the History of the Church of England to the Revolution of 1688.** By the Right Rev. T. V. SHORT, D.D. Bishop of St. Asaph. Crown 8vo. 10s. 6d.

**History of the Early Church, from the First Preaching of the Gospel to the Council of Nicea, A.D. 325.** By the Author of 'Amy Herbert.' Fcp. 4s. 6d.

**History of Wesleyan Methodism.** By GEORGE SMITH, F.A.S. Fourth Edition, with numerous Portraits. 3 vols. crown 8vo. 7s. each.

**The English Reformation.** By F. C. MASSINGBEARD, M.A. Chancellor of Lincoln. Fourth Edit. revised. Fcp. 7s. 6d.

### *Biography and Memoirs.*

**Dictionary of General Biography; containing Concise Memoirs and Notices of the most Eminent Persons of all Countries, from the Earliest Ages to the Present Time. With a Classified and Chronological Index of the Principal Names.** Edited by WILLIAM L. R. CATES. 8vo. 21s.

**Memoirs of Sir Philip Francis, K.C.B. with Correspondence and Journals.** Commenced by the late JOSEPH PARKES; completed and edited by HERMAN MERVILLE, M.A. 2 vols. 8vo. with Portrait and Facsimiles, 80s.

**Life of Baron Bunsen, by Baroness BUNSEN.** Drawn chiefly from Family Papers. With Two Portraits taken at different periods of the Baron's life, and several Lithographic Views. 2 vols. 8vo. [*Nearly ready.*]

**Life and Correspondence of Richard Whately, D.D. late Archbishop of Dublin.** By E. JANE WHATELY, Author of 'English Synonymes.' With 2 Portraits. 2 vols. 8vo. 28s.

**Extracts of the Journals and Correspondence of Miss Berry, from the Year 1788 to 1852.** Edited by Lady THERESA LEWIS. Second Edition, with 8 Portraits. 3 vols. 8vo. 42s.

**Life of the Duke of Wellington.** By the Rev. G. R. GLEIG, M.A. Popular Edition, carefully revised; with copious Additions. Crown 8vo. with Portrait, 5s.

**History of my Religious Opinions.** By J. H. NEWMAN, D.D. Being the Substance of Apologia pro Vita Sua. Post 8vo. 6s.

**Father Mathew: a Biography.** By JOHN FRANCIS MAGUIRE, M.P. Popular Edition, with Portrait. Crown 8vo. 3s. 6d.

**Home; its Rulers and its Institutions.** By the same Author. New Edition in preparation.

**Letters and Life of Francis Bacon, including all his Occasional Works.** Collected and edited, with a Commentary, by J. SPEDDING, Trin. Coll. Cantab. VOLS. I and II. 8vo. 24s.

**Life of Pastor Fliedner, Founder of the Deaconesses' Institution at Kaiserswerth.** Translated from the German, with the sanction of Fliedner's Family. By CATHERINE WINKWORTH. Fcp. 8vo. with Portrait, price 8s. 6d. [libtool.com.cn](http://libtool.com.cn)

**The Life of Franz Schubert,** translated from the German of KETZLE VON HELLBORN by ARTHUR DUKE COLBRIDGE, M.A. late Fellow of King's College, Cambridge. [Nearly ready.]

**Letters of Distinguished Musicians,** viz. Gluck, Haydn, P. E. Bach, Weber, and Mendelssohn. Translated from the German by Lady WALLACE, with Three Portraits. Post 8vo. 14s.

**Mozart's Letters (1769-1791),** translated from the Collection of Dr. LUDWIG NOHL by Lady WALLACE. 2 vols. post 8vo. with Portrait and Facsimile, 18s.

**Beethoven's Letters (1790-1826),** from the Two Collections of Dra. NOHL and VON KÖCHEL. Translated by Lady WALLACE. 2 vols. post 8vo. Portrait, 18s.

**Felix Mendelssohn's Letters from Italy and Switzerland, and Letters from 1838 to 1847,** translated by Lady WALLACE. With Portrait. 2 vols. crown 8vo. 5s. each.

**With Maximilian in Mexico.** From the Note-Book of a Mexican Officer. By MAX. BARON VON ALVENSLEBEN, late Lieutenant in the Imperial Mexican Army. Post 8vo. 7s. 6d.

**Memoirs of Sir Henry Havelock, K.C.B.** By JOHN CLARK MARSHMAN. Cabinet Edition, with Portrait. Crown 8vo. price 5s

**Faraday as a Discoverer: a Memoir.** By JOHN TYNDALL, LL.D. F.R.S. Professor of Natural Philosophy in the Royal Institution of Great Britain, and in the Royal School of Mines. Crown 8vo. [Nearly ready.]

**Essays in Ecclesiastical Biography.** By the Right Hon. Sir J. STEPHEN, LL.D. Cabinet Edition. Crown 8vo. 7s. 6d.

**Visciditudes of Families.** By Sir BERNARD BURKE, Ulster King of Arms. FIRST, SECOND, and THIRD SERIES. 3 vols. crown 8vo. 12s. 6d. each.

**Maunder's Biographical Treasury.** Thirteenth Edition, reconstructed and partly rewritten, with above 1,000 additional Memoirs, by W. L. R. CATES. Fcp. 10s. 6d.

### *Criticism, Philosophy, Polity, &c.*

**On Representative Government.** By JOHN STUART MILL, M.P. Third Edition. 8vo. 9s. crown 8vo. 2s.

**On Liberty.** By the same Author. Third Edition. Post 8vo. 7s. 6d. crown 8vo. 1s. 4d.

**Principles of Political Economy.** By the same. Sixth Edition. 2 vols. 8vo. 30s. or in 1 vol. crown 8vo. 5s.

**A System of Logic, Ratiocinative and Inductive.** By the same. Sixth Edition. 2 vols. 8vo. 25s.

**Utilitarianism.** By the same. 2d Edit. 8vo. 5s.

**Dissertations and Discussions.** By the same Author. 3 vols. 8vo. 36s.

**Examination of Sir W. Hamilton's Philosophy, and of the Principal Philosophical Questions discussed in his Writings.** By the same. Third Edition, 8vo. 16s.

**Workmen and Wages at Home and Abroad; or, the Effects of Strikes, Combinations, and Trade Unions.** By J. WARD, Author of 'The World in its Workshops,' &c. Post 8vo. 7s. 6d.

**The Elements of Political Economy.** By HENRY DUNNING MACLEOD, M.A. Barrister-at-Law. 8vo 16s.

**A Dictionary of Political Economy; Biographical, Bibliographical, Historical, and Practical.** By the same Author. Vol. I. royal 8vo. 30s.

**Lord Bacon's Works, collected and edited by R. L. ELLIS, M.A. J. SPEDDING, M.A. and D. D. HEATH.** VOLS. I. to V. *Philosophical Works*, 5 vols. 8vo. £4 6s. Vols. VI. and VII. *Literary and Professional Works*, 2 vols. £1 16s.

**The Institutes of Justinian; with English Introduction, Translation, and Notes.** By T. C. SANDARS, M.A. Barrister-at-Law. Third Edition. 8vo. 15s.

**The Ethics of Aristotle with Essays and Notes.** By Sir A. GRANT, Bart. M.A. LL.D. Director of Public Instruction in the Bombay Presidency. Second Edition, revised and completed. 2 vols. 8vo. price 28s.



**Bacon's Essays, with Annotations.**

By R. WHATLEY, D.D. late Archbishop of Dublin. Sixth Edition. 8vo. 10s. 6d.

**Elements of Logic.**

By R. WHATLEY, D.D. late Archbishop of Dublin. Ninth Edition. 8vo. 10s. 6d. crown 8vo. 4s. 6d.

**Elements of Rhetoric.**

By the same Author. Seventh Edition. 8vo. 10s. 6d. crown 8vo. 4s. 6d.

**English Synonymes.**

Edited by Archbishop WHATLEY. 5th Edition. Fcp. 3s.

**An Outline of the Necessary**

Laws of Thought: a Treatise on Pure and Applied Logic. By the Most Rev. W. THOMSON, D.D. Archbishop of York. Crown 8vo. 5s. 6d.

**Analysis of Mr. Mill's System of**

Logic. By W. STERLING, M.A. Second Edition. 12mo. 8s. 6d.

**The Election of Representatives,**

Parliamentary and Municipal; a Treatise. By THOMAS HARE, Barrister-at-Law. Third Edition, with Additions. Crown 8vo. 6s.

**Speeches on Parliamentary Reform,**

delivered in the House of Commons by the Right Hon. B. DISRAELI (1848-1866). Edited by MONTAGUE CORRY, B.A. of Lincoln's Inn, Barrister-at-Law. Second Edition. 8vo. 12s.

**Speeches of the Right Hon. Lord**

MACAULAY, corrected by Himself. Library Edition, 8vo. 12s. People's Edition, crown 8vo. 3s. 6d.

**Lord Macaulay's Speeches on**

Parliamentary Reform in 1831 and 1832. 16mo. 1s.

**Inaugural Address delivered to the**

University of St. Andrews. By JOHN STUART MILL, Rector of the University. Library Edition, 8vo. 5s. People's Edition, crown 8vo. 1s.

**A Dictionary of the English**

Language. By R. G. LATHAM, M.A. M.D. F.R.S. Founded on the Dictionary of Dr. S. JOHNSON, as edited by the Rev. H. J. TODD, with numerous Emendations and Additions. Publishing in 86 Parts, price 8s. 6d. each, to form 2 vols. 4to. VOL. I. in Two Parts, price £3 10s. now ready.

**Thesaurus of English Words and**

Phrases, classified and arranged so as to facilitate the Expression of Ideas, and assist in Literary Composition. By P. M. ROBERT, M.D. New Edition. Crown 8vo. 10s. 6d.

**Lectures on the Science of Lan-**

guage, delivered at the Royal Institution. By MAX MÜLLER, M.A. Taylorian Professor in the University of Oxford. FIRST SERIES, Fifth Edition, 12s. SECOND SERIES, 18s.

**Chapters on Language.**

By F. W. FARRAR, M.A. F.R.S. late Fellow of Trin. Coll. Cambridge. Crown 8vo. 8s. 6d.

**The Debater; a Series of Complete**

Debates, Outlines of Debates, and Questions for Discussion. By F. ROWTON. Fcp. 6s.

**A Course of English Reading,**

adapted to every taste and capacity; or, How and What to Read. By the Rev. J. PYCROFT, B.A. Fourth Edition, fcp. 5s.

**Manual of English Literature,**

Historical and Critical: with a Chapter on English Metres. By THOMAS ARNOLD, M.A. Second Edition. Crown 8vo. 7s. 6d.

**Southey's Doctor, complete in One**

Volume. Edited by the Rev. J. W. WARTER, B.D. Square crown 8vo. 12s. 6d.

**Historical and Critical Commen-**

tary on the Old Testament; with a New Translation. By M. M. KALISCH, Ph. D. VOL. I. *Genesis*, 8vo. 18s. or adapted for the General Reader, 12s. VOL. II. *Exodus*, 15s. or adapted for the General Reader, 12s. VOL. III. *Leviticus*, PART I. 15s. or adapted for the General Reader, 8s.

**A Hebrew Grammar, with Exercises.**

By the same. PART I. *Outlines with Exercises*, 8vo. 12s. 6d. KEY, 5s. PART II. *Exceptional Forms and Constructions*, 12s. 6d.

**A Latin-English Dictionary.**

By J. T. WHITE, D.D. of Corpus Christi College, and J. E. RIDDLE, M.A. of St. Edmund Hall, Oxford. Imp. 8vo. pp. 2,123, price 42s.

**A New Latin-English Dictionary,**

abridged from the larger work of *White and Riddle* (as above), by J. T. WHITE, D.D. Joint-Author. 8vo. pp. 1,048, price 18s.

**The Junior Scholar's Latin-English**

Dictionary, abridged from the larger works of *White and Riddle* (as above), by J. T. WHITE, D.D. Square 12mo. pp. 662, price 7s. 6d.

**An English-Greek Lexicon, con-**

taining all the Greek Words used by Writers of good authority. By C. D. YONGE, B.A. Fifth Edition. 4to. 21s.

**Mr. Yonge's New Lexicon, En-**

glish and Greek, abridged from his larger work (as above). Square 12mo. 8s. 6d.



- A Greek-English Lexicon.** Compiled by H. G. LIDDELL, D.D. Dean of Christ Church, and R. SCOTT, D.D. Master of Balliol. Fifth Edition, crown 4to. 81s. 6d.
- A Lexicon, Greek and English,** abridged from LIDDELL and SCOTT'S *Greek-English Lexicon*. Eleventh Edition, square 12mo. 7s. 6d.
- A Sanskrit-English Dictionary,** The Sanskrit words printed both in the original Devanagari and in Roman letters; with References to the Best Editions of Sanskrit Authors, and with Etymologies and Comparisons of Cognate Words chiefly in Greek, Latin, Gothic, and Anglo-Saxon. Compiled by T. BENFET. 8vo. 52s. 6d.
- A Practical Dictionary of the French and English Languages.** By Professor LÉON CONTANSEAU, many years French Examiner for Military and Civil Appointments, &c. 12th Edition, carefully revised. Post 8vo. 10s. 6d.
- Contanseau's Pocket Dictionary,** French and English, abridged from the above by the Author. New Edition. 18mo. price 3s. 6d.
- New Practical Dictionary of the German Language; German-English, and English-German.** By the Rev. W. L. BLACKLEY, M.A., and Dr. CARL MARTIN FRIEDLÄNDER. Post 8vo. 7s. 6d.

### Miscellaneous Works and Popular Metaphysics.

- Lessons of Middle Age,** with some Account of the Various Cities and Men. By A. K. H. B. Author of 'The Recreations of a Country Parson.' Post 8vo. 9s.
- Recreations of a Country Parson.** By A. K. H. B. SECOND SERIES. Crown 8vo. 3s. 6d.
- The Commonplace Philosopher in Town and Country.** By the same Author. Crown 8vo. 3s. 6d.
- Leisure Hours in Town; Essays** Consolatory, Aesthetical, Moral, Social, and Domestic. By the same. Crown 8vo. 3s. 6d.
- The Autumn Holidays of a Country Parson.** By the same. Crown 8vo. 3s. 6d.
- The Graver Thoughts of a Country Parson,** SECOND SERIES. By the same. Crown 8vo. 3s. 6d.
- Critical Essays of a Country Parson,** selected from Essays contributed to *Fraser's Magazine*. By the same. Crown 8vo. 3s. 6d.
- Sunday Afternoons at the Pariah Church** of a Scottish University City. By the same. Crown 8vo. 3s. 6d.
- Short Studies on Great Subjects.** By JAMES ANTHONY FROUDE, M.A. late Fellow of Exeter College, Oxford. Second Edition, complete in One Volume. 8vo. price 12s.
- Studies in Parliament: a Series of Sketches of Leading Politicians.** By R. H. HUTTON. (Reprinted from the *Pall Mall Gazette*.) Crown 8vo. 4s. 6d.
- Lord Macaulay's Miscellaneous Writings.** LIBRARY EDITION, 2 vols. 8vo. Portrait, 21s. PEOPLE'S EDITION, 1 vol. crown 8vo. 4s. 6d.
- The Rev. Sydney Smith's Miscellaneous Works;** including his Contributions to the *Edinburgh Review*. People's Edition, 2 vols. crown 8vo. 8s.
- Elementary Sketches of Moral Philosophy,** delivered at the Royal Institution. By the same Author. Fcp. 6s.
- The Wit and Wisdom of the Rev. SYDNEY SMITH:** a Selection of the most memorable Passages in his Writings and Conversation. 16mo. 5s.
- Epigrams, Ancient and Modern:** Humorous, Witty, Satirical, Moral, and Panegyric. Edited by Rev. JOHN BOOTH. B.A. Cambridge. Second Edition, revised and enlarged. Fcp. 7s. 6d.
- The Folk-Lore of the Northern Counties of England and the Borders.** By WILLIAM HENDERSON. With an Appendix on Household Stories by the Rev. S. BARING-GOULD. Crown 8vo. 9s. 6d.
- Christian Schools and Scholars;** or, Sketches of Education from the Christian Era to the Council of Trent. By the Author of 'The Three Chancellors,' &c. 2 vols. 8vo. price 80s.
- The Pedigree of the English People;** an Argument, Historical and Scientific, on the *Ethnology* of the English. By THOMAS NICHOLAS, M.A. Ph.D. 8vo. 16s.
- The English and their Origin:** a Prologue to authentic English History. By LUKE OWEN PIKE, M.A. Barrister-at-Law. 8vo. 9s.

- Essays selected from Contributions to the *Edinburgh Review*.** By HENRY ROGERS. Second Edition. 8 vols. fcp. 21s.
- Reason and Faith, their Claims and Conflicts.** By the same Author. New Edition, revised and extended. Crown 8vo. 6s. 6d.
- The Eclipse of Faith; or, a Visit to a Religious Sceptic.** By the same Author. Eleventh Edition. Fcp. 5s.
- Defence of the Eclipse of Faith, by its Author.** Third Edition. Fcp. 3s. 6d.
- Selections from the Correspondence of R. E. H. Greyson.** By the same Author. Third Edition. Crown 8vo. 7s. 6d.
- Chips from a German Workshop;** being Essays on the Science of Religion, and on Mythology, Traditions, and Customs. By MAX MÜLLER, M.A. Fellow of All Souls' College, Oxford. 2 vols. 8vo. 21s.
- The Secret of Hegel:** being the Hegelian System in Origin, Principle, Form, and Matter. By JAMES HUTCHISON STIRLING. 2 vols. 8vo. 28s.
- An Introduction to Mental Philosophy, on the Inductive Method.** By J. D. MORELL, M.A. LL.D. 8vo. 12s.
- Elements of Psychology, containing the Analysis of the Intellectual Powers.** By the same Author. Post 8vo. 7s. 6d.

- The Senses and the Intellect.** By ALEXANDER BAIRD, M.A. Prof. of Logic in the Univ. of Aberdeen. Second Edition. 8vo. 15s.
- The Emotions and the Will,** by the same Author. Second Edition. 8vo. 15s.
- On the Study of Character, including an Estimate of Phrenology.** By the same Author. 8vo. 9s.
- Time and Space: a Metaphysical Essay.** By SHADWORTH H. HODGSON. 8vo. price 16s.
- Occasional Essays.** By C. W. HOSKINS, Author of 'Talpa, or the Chronicles of a Clay Farm,' &c. 16mo. 5s. 6d.
- The Way to Rest: Results from a Life-search after Religious Truth.** By R. VAUGHAN, D.D. Crown 8vo. 7s. 6d.
- From Matter to Spirit.** By SOPHIA E. DE MORGAN. With a Preface by Professor DE MORGAN. Post 8vo. 8s. 6d.
- The Philosophy of Necessity; or, Natural Law as applicable to Mental, Moral, and Social Science.** By CHARLES BRAY. Second Edition. 8vo. 9s.
- The Education of the Feelings and Affections.** By the same Author. Third Edition. 8vo. 3s. 6d.
- On Force, its Mental and Moral Correlates.** By the same Author. 8vo. 5s.

### *Astronomy, Meteorology, Popular Geography, &c.*

- Outlines of Astronomy.** By Sir J. F. W. HERSCHEL, Bart, M.A. Ninth Edition, revised; with Plates and Woodcuts. 8vo. 18s.
- Saturn and its System.** By RICHARD A. PROCTOR, B.A. late Scholar of St. John's Coll. Camb. and King's Coll. London. 8vo. with 14 Plates, 14s.
- The Handbook of the Stars.** By the same Author. Square fcp. 8vo. with 8 Maps. price 5s.
- Celestial Objects for Common Telescopes.** By T. W. WEBB, M.A. F.R.A.S. Revised Edition, with Illustrations.  
[Nearly ready.]
- A General Dictionary of Geography, Descriptive, Physical, Statistical, and Historical;** forming a complete Gazetteer of the World. By A. KERTH JOHNSTON, F.R.S.E. New Edition, revised to July 1867. 8vo. 31s. 6d.

**M'Culloch's Dictionary, Geographical, Statistical, and Historical,** of the various Countries, Places, and principal Natural Objects in the World. Revised Edition, with the Statistical Information throughout brought up to the latest returns. By FREDERICK MARTIN. 4 vols. 8vo. with coloured Maps, £4 4s.

**A Manual of Geography, Physical, Industrial, and Political.** By W. HUGHES, F.R.G.S. Prof. of Geog. in King's Coll. and in Queen's Coll. Lond. With 6 Maps. Fcp. 7s. 6d.

**The States of the River Plate:** their Industries and Commerce, Sheep Farming, Sheep Breeding, Cattle Feeding, and Meat Preserving; the Employment of Capital, Land and Stock and their Values, Labour and its Remuneration. By WILFRID LATHAM, Buenos Ayres. Second Edition. 8vo. 12s.

**Hawaii: the Past, Present, and Future of its Island-Kingdom: an Historical Account of the Sandwich Islands.** By **MASLEY HOPKINS**, Hawaiian Consul-General, &c. Second Edition, revised and continued; with Portrait, Map, and 8 other Illustrations. Post 8vo. 12s. 6d.

**Maunder's Treasury of Geography, Physical, Historical, Descriptive, and Political.** Edited by **W. HUGHES, F.R.G.S.** With 7 Maps and 16 Plates. Fcp. 10s. 6d.

**Physical Geography for Schools and General Readers.** By **M. F. MAURY, LL.D.** Fcp. with 2 Charts, 2s. 6d.

### *Natural History and Popular Science.*

**Elementary Treatise on Physics, Experimental and Applied, for the use of Colleges and Schools.** Translated and edited from **GANON'S 'Elements de Physique'** (with the Author's sanction) by **E. ATKINSON, Ph.D. F.C.S.** New Edition, revised and enlarged; with a Coloured Plate and 620 Woodcuts. Post 8vo. 15s.

**The Elements of Physics or Natural Philosophy.** By **NEIL ARMOUR, M.D. F.R.S.** Physician Extraordinary to the Queen. Sixth Edition, rewritten and completed. 2 Parts, 8vo. 21s.

**Dove's Law of Storms, considered in connexion with the ordinary Movements of the Atmosphere.** Translated by **R. H. SCOTT, M.A. T.C.D.** 8vo. 10s. 6d.

**Rocks Classified and Described.** By **BERNHARD VON COTTA.** An English Edition, by **P. H. LAWRENCE** (with English, German, and French Synonymes), revised by the Author. Post 8vo. 14s.

**Sound: a Course of Eight Lectures delivered at the Royal Institution of Great Britain.** By Professor **JOHN TYNDALL, LL.D. F.R.S.** Crown 8vo. with Portrait and Woodcuts, 9s.

**Heat Considered as a Mode of Motion.** By Professor **JOHN TYNDALL, LL.D. F.R.S.** Third Edition. Crown 8vo. with Woodcuts, 10s. 6d.

**Light: its Influence on Life and Health.** By **FORDOS WINSLOW, M.D. D.C.L. Oxon.** (Hon.). Fcp. 8vo. 6s.

**An Essay on Dew, and several Appearances connected with it.** By **W. C. WELLS.** Edited, with Annotations, by **L. P. CASELLA, F.R.A.S.** and an Appendix by **R. STRACHAN, F.M.S.** 8vo. 5s.

**A Treatise on Electricity, in Theory and Practice.** By **A. DE LA RIVE, Prof. in the Academy of Geneva.** Translated by **C. V. WALKER, F.R.S.** 8 vols. 8vo. with Woodcuts, £3 18s.

**A Preliminary Discourse on the Study of Natural Philosophy.** By **Sir JOHN F. W. HERSCHEL, Bart.** Revised Edition, with Vignette Title. Fcp. 3s. 6d.

**The Correlation of Physical Forces.** By **W. R. GROVE, Q.C. V.P.R.S.** Fifth Edition, revised, and augmented by a Discourse on Continuity. 8vo. 10s. 6d. The *Discourse on Continuity*, separately, price 2s. 6d.

**Manual of Geology.** By **S. HAUGHTON, M.D. F.R.S.** Fellow of Trin. Coll. and Prof. of Geol. in the Univ. of Dublin. Second Edition, with 66 Woodcuts. Fcp. 7s. 6d.

**A Guide to Geology.** By **J. PHILLIPS, M.A.** Prof. of Geol. in the Univ. of Oxford. Fifth Edition. Fcp. 4s.

**A Glossary of Mineralogy.** By **H. W. BRISTOW, F.G.S.** of the Geological Survey of Great Britain. With 486 Figures. Crown 8vo. 6s.

**Van Der Hoeven's Handbook of Zoology.** Translated from the Second Dutch Edition by the **Rev. W. CLARK, M.D. F.R.S.** 2 vols. 8vo. with 24 Plates of Figures, 60s.

**Professor Owen's Lectures on the Comparative Anatomy and Physiology of the Invertebrate Animals.** Second Edition, with 235 Woodcuts. 8vo. 21s.

**The Comparative Anatomy and Physiology of the Vertebrate Animals.** By **RICHARD OWEN, F.R.S. D.C.L.** 8 vols. 8vo. with upwards of 1,200 Woodcuts. Vols. I. and II. price 21s. each. VOL. III. (completing the work) is nearly ready.

**The First Man and His Place in Creation, considered on the Principles of Common Sense from a Christian Point of View; with an Appendix on the Negro.** By **GEORGE MOORE, M.D. M.R.C.P.L. &c.** Post 8vo. 8s. 6d.

**The Primitive Inhabitants of Scandinavia:** an Essay on Comparative Ethnography, and a contribution to the History of the Development of Mankind. Containing a description of the Implements, Dwellings, Tombs, and Mode of Living of the Savages in the North of Europe during the Stone Age. By SVEN NILSSON. Translated from the Author's MS. of the Third Edition; with an Introduction by Sir JOHN LUBBOCK. 8vo. with numerous Plates. [*Nearly ready.*]

**The Lake Dwellings of Switzerland and other Parts of Europe.** By Dr. F. KELLER, President of the Antiquarian Association of Zürich. Translated and arranged by J. E. LEE, F.S.A. F.G.S. Author of 'Isca Silurum.' With several Woodcuts and nearly 100 Plates of Figures. Royal 8vo. 31s. 6d.

**Homes without Hands:** a Description of the Habitations of Animals, classed according to their Principles of Construction. By Rev. J. G. WOOD, M.A. F.L.S. With about 140 Vignettes on Wood (20 full size of page). Second Edition. 8vo. 21s.

**Bible Animals;** being an Account of the various Birds, Beasts, Fishes, and other Animals mentioned in the Holy Scriptures. By the Rev. J. G. WOOD, M.A. F.L.S. Copiously Illustrated with Original Designs, made under the Author's superintendence and engraved on Wood. In course of publication monthly, to be completed in 20 Parts, price 1s. each, forming One Volume, uniform with 'Homes without Hands.'

**The Harmonies of Nature and Unity of Creation.** By Dr. G. HARTWIG, 8vo. with numerous Illustrations, 18s.

**The Sea and its Living Wonders.** By the same Author. Third Edition, enlarged. 8vo. with many Illustrations, 21s.

**The Tropical World.** By the same Author. With 8 Chromoxylographs and 172 Woodcuts. 8vo. 21s.

**The Polar World:** a Popular Account of Nature and Man in the Arctic and Antarctic Regions. By the same Author. 8vo. with numerous Illustrations. [*Nearly ready.*]

**Ceylon.** By Sir J. EMERSON TENNENT, K.C.S. LL.D. 5th Edition; with Maps, &c. and 90 Wood Engravings. 2 vols. 8vo. £2 10s.

**The Wild Elephant, its Structure and Habits, with the Method of Taking and Training it in Ceylon.** By the same Author. Fcp. with 22 Woodcuts, 3s. 6d.

**Manual of Corals and Sea Jellies.** By J. R. GREENE, B.A. Edited by J. A. GALBRAITH, M.A. and S. HAUGHTON, M.D. Fcp. with 39 Woodcuts, 5s.

**Manual of Sponges and Animalcules;** with a General Introduction on the Principles of Zoology. By the same Author and Editors. Fcp. with 16 Woodcuts. 2s.

**Manual of the Metalloids.** By J. APJOHN, M.D. F.R.S. and the same Editors. 2nd Edition. Fcp. with 38 Woodcuts, 7s. 6d.

**A Familiar History of Birds.** By E. STANLEY, D.D. late Lord Bishop of Norwich. Fcp. with Woodcuts, 8s. 6d.

**Kirby and Spence's Introduction to Entomology, or Elements of the Natural History of Insecta.** Crown 8vo. 5s.

**Maunder's Treasury of Natural History, or Popular Dictionary of Zoology.** Revised and corrected by T. S. COSMOLD, M.D. Fcp. with 900 Woodcuts, 10s.

**The Elements of Botany for Families and Schools.** Tenth Edition, revised by THOMAS MOORE, F.L.S. Fcp. with 154 Woodcuts, 2s. 6d.

**The Treasury of Botany, or Popular Dictionary of the Vegetable Kingdom;** with which is incorporated a Glossary of Botanical Terms. Edited by J. LINDLEY, F.R.S. and T. MOORE, F.L.S. assisted by eminent Contributors. Pp. 1,274, with 274 Woodcuts and 20 Steel Plates. 2 Parts, fcp. 20s.

**The British Flora;** comprising the Phanogamous or Flowering Plants and the Ferns. By Sir W. J. HOOKER, K.H. and G. A. WALKER-ARNOTT, LL.D. 12mo. with 12 Plates, 14s. or coloured, 21s.

**The Rose Amateur's Guide.** By THOMAS RIVERS. New Edition. Fcp. 4s.

**London's Encyclopaedia of Plants;** comprising the Specific Character, Description, Culture, History, &c. of all the Plants found in Great Britain. With upwards of 12,000 Woodcuts. 8vo. 42s.

**London's Encyclopaedia of Trees and Shrubs;** containing the Hardy Trees and Shrubs of Great Britain scientifically and popularly described. With 2,000 Woodcuts, 8vo. 50s.

**Maunder's Scientific and Literary Treasury;** a Popular Encyclopaedia of Science, Literature, and Art. New Edition, thoroughly revised and in great part rewritten, with above 1,000 new articles, by J. Y. JOHNSON, Corr. M.Z.S. Fcp. 10s. 6d.

**A Dictionary of Science, Literature, and Art.** Fourth Edition, re-edited by the late W. T. BRANDE (the Author) and GEORGE W. COX, M.A. 3 vols. medium 8vo. price 63s. cloth.

[www.libtool.com.cn](http://www.libtool.com.cn)

*Chemistry, Medicine, Surgery, and the Allied Sciences.*

**A Dictionary of Chemistry and the Allied Branches of other Sciences.** By HENRY WATTS, F.C.S. assisted by eminent Contributors. 5 vols. medium 8vo. in course of publication in Parts. VOL. I. 81s. 6d. VOL. II. 26s. VOL. III. 81s. 6d. and VOL. IV. 24s. are now ready.

**Handbook of Chemical Analysis,** adapted to the *Unitary System* of Notation. By F. T. CONINGTON, M.A. F.C.S. Post 8vo. 7s. 6d.

Conington's **Tables of Qualitative Analysis,** to accompany the above, 2s. 6d.

**Elements of Chemistry, Theoretical and Practical.** By WILLIAM A. MILLER, M.D. LL.D. Professor of Chemistry, King's College, London. 8 vols. 8vo. £3. PART I. CHEMICAL PHYSICS, Revised Edition, 15s. PART II. INORGANIC CHEMISTRY, 21s. PART III. ORGANIC CHEMISTRY, 24s.

**A Manual of Chemistry, Descriptive and Theoretical.** By WILLIAM ODLING, M.B. F.R.S. PART I. 8vo. 9s. PART II. nearly ready.

**A Course of Practical Chemistry,** for the use of Medical Students. By the same Author. New Edition, with 70 new Woodcuts. Crown 8vo. 7s. 6d.

**Lectures on Animal Chemistry** Delivered at the Royal College of Physicians in 1865. By the same Author. Crown 8vo. 4s. 6d.

**The Toxicologist's Guide:** a New Manual on Poisons, giving the Best Methods to be pursued for the Detection of Poisons. By J. HORSLEY, F.C.S. Analytical Chemist. Post 8vo. 8s. 6d.

**The Diagnosis, Pathology, and Treatment of Diseases of Women;** including the Diagnosis of Pregnancy. By GRAILY HEWITT, M.D. &c. Second Edition, enlarged; with 116 Woodcut Illustrations. 8vo. 24s.

**Essays from the Edinburgh and Quarterly Reviews;** with Addresses and other Pieces. By Sir J. F. W. HERSCHEL, Bart. M.A. 8vo. 18s.

**Lectures on the Diseases of Infancy and Childhood.** By CHARLES WEST, M.D. &c. 5th Edition, revised and enlarged. 8vo. 16s.

**Exposition of the Signs and Symptoms of Pregnancy:** with other Papers on subjects connected with Midwifery. By W. F. MONTGOMERY, M.A. M.D. M.R.I.A. 8vo. with Illustrations, 25s.

**A System of Surgery, Theoretical and Practical,** in Treatises by Various Authors. Edited by T. HOLMES, M.A. Cantab. Assistant-Surgeon to St. George's Hospital. 4 vols. 8vo. £4 13s.

Vol. I. General Pathology, 21s.

Vol. II. Local Injuries: Gun-shot Wounds, Injuries of the Head, Back, Face, Neck, Chest, Abdomen, Pelvis, of the Upper and Lower Extremities, and Diseases of the Eye. 21s.

Vol. III. Operative Surgery. Diseases of the Organs of Circulation, Locomotion, &c. 21s.

Vol. IV. Diseases of the Organs of Digestion, of the Genito-Urinary System, and of the Breast, Thyroid Gland, and Skin; with APPENDIX and GENERAL INDEX. 80s.

**Lectures on the Principles and Practice of Physic.** By THOMAS WATSON, M.D. Physician-Extraordinary to the Queen. New Edition in preparation.

**Lectures on Surgical Pathology.** By J. PAGET, F.R.S. Surgeon-Extraordinary to the Queen. Edited by W. TURNER, M.B. New Edition in preparation.

**A Treatise on the Continued Fevers of Great Britain.** By C. MURCHISON, M.D. Senior Physician to the London Fever Hospital. 8vo. with coloured Plates, 18s.

**Outlines of Physiology, Human and Comparative.** By JOHN MARSHALL, F.R.C.S. Professor of Surgery in University College, London, and Surgeon to the University College Hospital. 2 vols. crown 8vo. with 122 Woodcuts, 32s.

**Anatomy, Descriptive and Surgical.** By HENRY GRAY, F.R.S. With 410 Wood Engravings from Dissections. Fourth Edition, by T. HOLMES, M.A. Cantab. Royal 8vo. 28s.

**The Cyclopaedia of Anatomy and Physiology.** Edited by the late R. B. TODD, M.D. F.R.S. Assisted by nearly all the most eminent cultivators of Physiological Science of the present age. 5 vols. 8vo. with 2,858 Woodcuts, £8 6s.

**Physiological Anatomy and Physiology of Man.** By the late R. B. TODD, M.D. F.R.S. and W. BOWMAN, F.R.S. of King's College. With numerous Illustrations. VOL. II. 8vo. 25s.

VOL. I. New Edition by Dr. LIONEL S. BEALE, F.R.S. in course of publication; PART I. with 8 Plates, 7s. 6d.

**Histological Demonstrations; a Guide to the Microscopical Examination of the Animal Tissues in Health and Disease, for the use of the Medical and Veterinary Professions.** By G. HARLEY, M.D. F.R.S. Prof. in Univ. Coll. London; and G. T. BROWN, M.R.C.V.S. Professor of Veterinary Medicine, and one of the Inspecting Officers in the Cattle Plague Department of the Privy Council. Post 8vo. with 228 Woodcuts, 12s.

**A Dictionary of Practical Medicine.** By J. COPLAND, M.D. F.R.S. Abridged from the larger work by the Author, assisted by J. C. COPLAND, M.R.C.S. and throughout brought down to the present state of Medical Science. Pp. 1,560, in 8vo. price 86s.

**The Works of Sir B. C. Brodie, Bart.** collected and arranged by CHARLES HAWKINS, F.R.C.S.E. 8 vols. 8vo. with Medallion and Facsimile, 48s.

**A Manual of Materia Medica and Therapeutics,** abridged from Dr. PEREIRA'S *Elements* by F. J. FARRE, M.D. assisted by R. BENTLEY, M.R.C.S. and by R. WARINGTON, F.R.S. 1 vol. 8vo. with 90 Woodcuts, 21s.

**Thomson's Conspectus of the British Pharmacopoeia.** Twenty-fourth Edition, corrected by E. LLOYD BIRKETT, M.D. 18mo. 5s. 6d.

**Manual of the Domestic Practice of Medicine.** By W. B. KESTVEN, F.R.C.S.E. Third Edition, thoroughly revised, with Additions. Fcp. 5s.

**Sea-Air and Sea-Bathing for Children and Invalids.** By WILLIAM STRANGE, M.D. Fcp. 8s.

**The Restoration of Health; or, the Application of the Laws of Hygiene to the Recovery of Health: a Manual for the Invalid, and a Guide in the Sick Room.** By W. STRANGE, M.D. Fcp. 6s.

**Gymnasts and Gymnastics.** By JOHN H. HOWARD, late Professor of Gymnastics, Comm. Coll. Ripponden. Second Edition, revised and enlarged, with various Selections from the best Authors, containing 445 Exercises; and illustrated with 185 Woodcuts, including the most Recent Improvements in the different Apparatus now used in the various Clubs, &c. Crown 8vo. 10s. 6d.

### *The Fine Arts, and Illustrated Editions.*

**Half-Hour Lectures on the History and Practice of the Fine and Ornamental Arts.** By W. B. SCOTT. Second Edition. Crown 8vo. with 50 Woodcut Illustrations, 8s. 6d.

**An Introduction to the Study of National Music; Comprising Researches into Popular Songs, Traditions, and Customs.** By CARL ENGEL. With Frontispiece and numerous Musical Illustrations. 8vo. 16s.

**Lectures on the History of Modern Music,** delivered at the Royal Institution. By JOHN HULLAH. FIRST COURSE, with Chronological Tables, post 8vo. 6s. 6d. SECOND COURSE, the Transition Period, with 26 Specimens, 8vo. 16s.

**The Chorale Book for England;** a complete Hymn-Book in accordance with the Services and Festivals of the Church of England: the Hymns translated by Miss C. WICKWORTH; the Tunes arranged by Prof. W. S. BENNETT and OTTO GOLDSCHMIDT. Fcp. 4to. 12s. 6d.

Congregational Edition. Fcp. 2s.

**Six Lectures on Harmony.** Delivered at the Royal Institution of Great Britain before Easter 1867. By G. A. MACFARREN. 8vo. 10s. 6d.

**Sacred Music for Family Use;** A Selection of Pieces for One, Two, or more Voices, from the best Composers, Foreign and English. Edited by JOHN HULLAH. 1 vol. music folio, 21s.



**The New Testament**, illustrated with Wood Engravings after the Early Masters, chiefly of the Italian School. Crown 4to. 68s. cloth, gilt top; or £5 5s. morocco.

**Lyra Germanica, the Christian Year.** Translated by CATHERINE WENKWOORTH; with 125 Illustrations on Wood drawn by J. LEIGHTON, F.S.A. Quarto, 21s.

**Lyra Germanica, the Christian Life.** Translated by CATHERINE WENKWOORTH; with about 200 Woodcut Illustrations by J. LEIGHTON, F.S.A. and other Artists. Quarto, 21s.

**The Life of Man Symbolised by the Months of the Year in their Seasons and Phases; with Passages selected from Ancient and Modern Authors.** By RICHARD PROOR. Accompanied by a Series of 25 full-page Illustrations and numerous Marginal Devices, Decorative Initial Letters, and Tailpieces, engraved on Wood from Original Designs by JOHN LEIGHTON, F.S.A. Quarto, 42s.

**Cats' and Fables' Moral Emblems; with Aphorisms, Adages, and Proverbs of all Nations: comprising 121 Illustrations on Wood by J. LEIGHTON, F.S.A. with an appropriate Text by R. PROOR.** Imperial 8vo. 81s. 6d.

**Shakspeare's Sentiments and Similes** printed in Black and Gold, and illuminated in the Missal style by HENRY NOEL HUMPHREYS. In massive covers, containing the Medallion and Cypher of Shakspeare. Square post 8vo. 21s.

**Sacred and Legendary Art.** By Mrs. JAMESON. With numerous Etchings and Woodcut Illustrations. 6 vols. square crown 8vo. price £5 15s. 6d. cloth, or £12 12s. bound in morocco by Rivière. To be had also in cloth only, in FOUR SERIES, as follows:—

**Legends of the Saints and Martyrs.** Fifth Edition, with 19 Etchings and 187 Woodcuts. 2 vols. square crown 8vo. 81s. 6d.

**Legends of the Monastic Orders.** Third Edition, with 11 Etchings and 88 Woodcuts. 1 vol. square crown 8vo. 21s.

**Legends of the Madonna.** Third Edition, with 27 Etchings and 165 Woodcuts. 1 vol. square crown 8vo. 21s.

**The History of Our Lord, as exemplified in Works of Art.** Completed by Lady EASTLAKE. Second Edition, with 18 Etchings and 281 Woodcuts. 2 vols. square crown 8vo. 42s.

### *Arts, Manufactures, &c.*

**Drawing from Nature; a Series of Progressive Instructions in Sketching, from Elementary Studies to Finished Views, with Examples from Switzerland and the Pyrenees.** By GEORGE BARNARD, Professor of Drawing at Rugby School. With 18 Lithographic Plates and 108 Wood Engravings. Imp. 8vo. 25s. or in Three Parts, royal 8vo. 7s. 6d. each.

**Gwilt's Encyclopedia of Architecture.** Fifth Edition, with Alterations and considerable Additions, by WYATT PAPWORTH. Additionally illustrated with nearly 400 Wood Engravings by O. JEWITT, and upwards of 100 other new Woodcuts. 8vo. 52s. 6d.

**Tuscan Sculptors, their Lives, Works, and Times.** With 45 Etchings and 28 Woodcuts from Original Drawings and Photographs. By CHARLES C. PERKINS. 2 vols. imp. 8vo. 68s.

**Original Designs for Wood-Carving, with Practical Instructions in the Art.** By A. F. B. With 20 Plates of Illustrations engraved on Wood. Quarto, 18s.

**The Grammar of Heraldry: containing a Description of all the Principal Charges used in Armory, the Signification of Heraldic Terms, and the Rules to be observed in Blazoning and Marshalling.** By JOHN E. CUSSANS. Fcp. with 196 Woodcuts, 4s. 6d.

**Hints on Household Taste in Furniture and Decoration.** By CHARLES L. EASTLAKE, Architect. With numerous Illustrations engraved on Wood. [*Nearly ready.*]

**The Engineer's Handbook; explaining the Principles which should guide the young Engineer in the Construction of Machinery.** By C. S. LOWMEYER. Post 8vo. 5s.

**The Elements of Mechanism.**

By T. M. GOODEVE, M.A. Prof. of Mechanics at the R. M. Acad. Woolwich. Second Edition, with 217 Woodcuts. Post 8vo. 6s. 6d.

**Ure's Dictionary of Arts, Manufactures, and Mines.**

Sixth Edition, chiefly re-written and greatly enlarged by ROBERT HUNT, F.R.S., assisted by numerous Contributors eminent in Science and the Arts, and familiar with Manufactures. With 2,000 Woodcuts. 8 vols. medium 8vo. £4 14s. 6d.

**Treatise on Mills and Millwork.**

By W. FAIRBAIRN, C.E. F.R.S. With 18 Plates and 322 Woodcuts. 2 vols. 8vo. 32s.

**Useful Information for Engineers.** By the same Author. FIRST, SECOND, and THIRD SERIES, with many Plates and Woodcuts. 8 vols. crown 8vo. 10s. 6d. each.

**The Application of Cast and Wrought Iron to Building Purposes.** By the same Author. Third Edition, with 6 Plates and 118 Woodcuts. 8vo. 16s.

**Iron Ship Building, its History and Progress,** as comprised in a Series of Experimental Researches on the Laws of Strain; the Strengths, Forms, and other conditions of the Material; and an Inquiry into the Present and Prospective State of the Navy, including the Experimental Results on the Resisting Powers of Armour Plates and Shot at High Velocities. By W. FAIRBAIRN, C.E. F.R.S. With 4 Plates and 180 Woodcuts, 8vo. 18s.

**Encyclopædia of Civil Engineering,** Historical, Theoretical, and Practical. By E. CRESEY, C.E. With above 3,000 Woodcuts. 8vo. 42s.

**The Artisan Club's Treatise on the Steam Engine,** in its various Applications to Mines, Mills, Steam Navigation, Railways, and Agriculture. By J. BOURNE, C.E. New Edition; with 87 Plates and 546 Woodcuts. 4to. 42s.

**A Treatise on the Screw Propeller, Screw Vessels, and Screw Engines,** as adapted for purposes of Peace and War; with notices of other Methods of Propulsion, Tables of the Dimensions and Performance of Screw Steamers, and Detailed Specifications of Ships and Engines. By the same Author. Third Edition, with 54 Plates and 287 Woodcuts. Quarto, 68s.

**Catechism of the Steam Engine,** in its various Applications to Mines, Mills, Steam Navigation, Railways, and Agriculture. By JOHN BOURNE, C.E. New Edition, with 199 Woodcuts. Fcp. 6s.

**Handbook of the Steam Engine,** by the same Author, forming a KEY to the Catechism of the Steam Engine, with 67 Woodcuts. Fcp. 9s.

**A History of the Machine-Wrought Hosiery and Lace Manufactures.** By WILLIAM FELKIN, F.L.S. F.S.S. With 8 Steel Plates, 10 Lithographic Plates of Machinery, and 10 Coloured Impressions of Patterns of Lace. Royal 8vo. 21s.

**Manual of Practical Assaying,** for the use of Metallurgists, Captains of Mines, and Assayers in general; with copious Tables for Ascertaining in Assays of Gold and Silver the precise amount in Ounces, Pennyweights, and Grains of Noble Metal contained in One Ton of Ore from a Given Quantity. By JOHN MITCHELL, F.C.S. 8vo. with 860 Woodcuts, 21s.

**The Art of Perfumery; the History and Theory of Odours, and the Methods of Extracting the Aromas of Plants.** By Dr. PRINCE, F.C.S. Third Edition, with 58 Woodcuts. Crown 8vo. 10s. 6d.

**Chemical, Natural, and Physical Magic,** for Juveniles during the Holidays. By the same Author. Third Edition, enlarged with 88 Woodcuts. Fcp. 6s.

**Loudon's Encyclopædia of Agriculture:** Comprising the Laying-out, Improvement, and Management of Landed Property, and the Cultivation and Economy of the Productions of Agriculture. With 1,100 Woodcuts. 8vo. 31s. 6d.

**Loudon's Encyclopædia of Gardening:** Comprising the Theory and Practice of Horticulture, Floriculture, Arboriculture, and Landscape Gardening. With 1,000 Woodcuts. 8vo. 31s. 6d.

**Loudon's Encyclopædia of Cottage, Farm, and Villa Architecture and Furniture.** With more than 2,000 Woodcuts. 8vo. 42s.

**Garden Architecture and Landscape Gardening,** illustrating the Architectural Embellishment of Gardens; with Remarks on Landscape Gardening in its relation to Architecture. By JOHN ARTHUR HUGHES. 8vo. with 194 Woodcuts, 14s.

**Bayldon's Art of Valuing Rents and Tillages, and Claims of Tenants upon Quitting Farms,** both at Michaelmas and Lady-Day. Eighth Edition, revised by J. C. MORRIS. 8vo. 10s. 6d.



*Religious and Moral Works.*

- An Exposition of the 39 Articles, Historical and Doctrinal.** By E. HAROLD BROWNE, D.D. Lord Bishop of Ely. Seventh Edition. 8vo. 16s.
- Examination-Questions on Bishop Browne's Exposition of the Articles.** By the Rev. J. GORLE, M.A. Fcp. 8s. 6d.
- The Life and Reign of David King of Israel.** By GEORGE SMITH, LL.D. F.A.S. Crown 8vo. 7s. 6d.
- The Acts of the Apostles; with a Commentary, and Practical and Devotional Suggestions for Readers and Students of the English Bible.** By the Rev. F. C. COOK, M.A., Canon of Exeter, &c. New Edition, 8vo. 12s. 6d.
- The Life and Epistles of St. Paul.** By W. J. CONYBEARE, M.A. late Fellow of Trin. Coll. Cantab. and J. S. HOWSON, D.D. Principal of Liverpool Coll. LIBRARY EDITION, with all the Original Illustrations, Maps, Landscapes on Steel, Woodcuts, &c. 2 vols. 4to. 48s.
- INTERMEDIATE EDITION, with a Selection of Maps, Plates, and Woodcuts. 2 vols. square crown 8vo. 81s. 6d.
- PEOPLE'S EDITION, revised and condensed, with 46 Illustrations and Maps. 2 vols. crown 8vo. 12s.
- The Voyage and Shipwreck of St. Paul; with Dissertations on the Ships and Navigation of the Ancients.** By JAMES SMITH, F.R.S. Crown 8vo. Charts, 10s. 6d.
- Evidence of the Truth of the Christian Religion derived from the Literal Fulfilment of Prophecy, particularly as Illustrated by the History of the Jews, and the Discoveries of Recent Travellers.** By ALEXANDER KEITH, D.D. 87th Edition, with numerous Plates, in square 8vo. 12s. 6d.; also the 89th Edition, in post 8vo. with 5 Plates, 6s.
- The History and Destiny of the World and of the Church, according to Scripture.** By the same Author. Square 8vo. with 40 Illustrations, 10s.
- History of Israel to the Death of Moses.** By HEINRICH EWALD, Professor of the University of Göttingen. Translated from the German. Edited, with a Preface, by RUSSELL MARTINEAU, M.A. Professor of Hebrew in Manchester New College, London. 8vo. 18s.
- A Critical and Grammatical Commentary on St. Paul's Epistles.** By C. J. ELLICOTT, D.D. Lord Bishop of Gloucester and Bristol. 8vo.
- Galatians, Third Edition, 8s. 6d.**
- Ephesians, Fourth Edition, 8s. 6d.**
- Pastoral Epistles, Third Edition, 10s. 6d.**
- Philippians, Colossians, and Philemon, Third Edition, 10s. 6d.**
- Thessalonians, Third Edition, 7s. 6d.**
- Historical Lectures on the Life of Our Lord Jesus Christ: being the Hulsean Lectures for 1859.** By the same Author. Fourth Edition. 8vo. 10s. 6d.
- The Destiny of the Creature; and other Sermons preached before the University of Cambridge.** By the same. Post 8vo. 5s.
- The Greek Testament; with Notes, Grammatical and Exegetical.** By the Rev. W. WEBSTER, M.A. and the Rev. W. F. WILKINSON, M.A. 2 vols. 8vo. £2 4s.
- VOL. I. the Gospels and Acts, 20s.
- VOL. II. the Epistles and Apocalypse, 24s.
- An Introduction to the Study of the New Testament, Critical, Exegetical, and Theological.** By the Rev. S. DAVIDSON, D.D. LL.D. 2 vols. 8vo. [*In the press.*]
- Rev. T. H. Horne's Introduction to the Critical Study and Knowledge of the Holy Scriptures.** Eleventh Edition, corrected, and extended under careful Editorial revision. With 4 Maps and 22 Woodcuts and Facsimiles. 4 vols. 8vo. £3 18s. 6d.
- Rev. T. H. Horne's Compendious Introduction to the Study of the Bible, being an Analysis of the larger work by the same Author.** Re-edited by the Rev. JOHN AYRE, M.A. With Maps, &c. Post 8vo. 9s.
- The Treasury of Bible Knowledge; being a Dictionary of the Books, Persons, Places, Events, and other Matters of which mention is made in Holy Scripture; intended to establish its Authority and illustrate its Contents.** By Rev. J. AYRE, M.A. With Maps, 15 Plates, and numerous Woodcuts. Fcp. 10s. 6d.
- Every-day Scripture Difficulties explained and illustrated.** By J. E. PRESCOTT, M.A. VOL. I. *Matthew and Mark*; VOL. II. *Luke and John*. 2 vols. 8vo. 9s. each.

**The Pentateuch and Book of Joshua Critically Examined.** By the Right Rev. J. W. COLENSO, D.D. Lord Bishop of Natal. People's Edition, in 1 vol. crown 8vo. 6s. or in 5 Parts, 1s. each.

**The Church and the World: Essays on Questions of the Day.** By various Writers. Edited by Rev. ORBY SHIPLEY, M.A. FIRST and SECOND SERIES. 2 vols. 8vo. 15s. each. THIRD SERIES preparing for publication.

**Tracts for the Day; a Series of Essays on Theological Subjects.** By various Authors. Edited by the Rev. ORBY SHIPLEY, M.A. I. *Priestly Absolution Scriptural*, 9d. II. *Purgatory*, 9d. III. *The Seven Sacraments*, 1s. 6d. IV. *Miracles and Prayer*, 6d. V. *The Real Presence*, 1s. 3d. VI. *Casistry*, 1s. VII. *Uction of the Sick*, 9d. VIII. *The Rule of Worship*, 9d. IX. *Popular Rationalism*, 9d.

**The Formation of Christendom.** PART I. By T. W. ALLIES. 8vo. 12s.

**Christendom's Divisions; a Philosophical Sketch of the Divisions of the Christian Family in East and West.** By EDMUND S. FFOULKES, formerly Fellow and Tutor of Jesus Coll. Oxford. Post 8vo. 7s. 6d.

**Christendom's Divisions, Part II. Greeks and Latins,** being a History of their Dissentions and Overtures for Peace down to the Reformation. By the same Author. Post 8vo. 15s.

**The Hidden Wisdom of Christ and the Key of Knowledge; or, History of the Apocrypha.** By ERNEST DE BUNSEN. 2 vols. 8vo. 28s.

**The Keys of St. Peter; or, the House of Rechab,** connected with the History of Symbolism and Idolatry. By the same Author. 8vo. 14s.

**The Temporal Mission of the Holy Ghost; or, Reason and Revelation.** By Archbishop MANNING, D.D. Second Edition. Crown 8vo. 8s. 6d.

**England and Christendom.** By the same Author. Preceded by an Introduction on the Tendencies of Religion in England, and the Catholic Practice of Prayer for the Restoration of Christian Nations to the Unity of the Church. Post 8vo. 10s. 6d.

**Essays on Religion and Literature.** Edited by Archbishop MANNING, D.D. FIRST SERIES, 8vo. 10s. 6d. SECOND SERIES, 14s.

**Essays and Reviews.** By the Rev. W. TEMPLE, D.D. the Rev. R. WILLIAMS, B.D. the Rev. B. POWELL, M.A. the Rev. H. B. WILSON, B.D. C. W. GOODWIN, M.A. the Rev. M. PATTISON, B.D. and the Rev. B. JOWETT, M.A. 12th Edition. Fcp. 5s.

**Mosheim's Ecclesiastical History.** MURDOCK and SOAMES's Translation and Notes, re-edited by the Rev. W. STUBBS, M.A. 8 vols. 8vo. 45s.

**Bishop Jeremy Taylor's Entire Works: With Life** by BISHOP HEBER. Revised and corrected by the Rev. C. P. EDEN, 10 vols. £5 5s.

**Passing Thoughts on Religion.** By the Author of 'Amy Herbert.' New Edition. Fcp. 6s.

**Self-examination before Confirmation.** By the same Author. 82mo. 1s. 6d.

**Readings for a Month Preparatory to Confirmation** from Writers of the Early and English Church. By the same. Fcp. 4s.

**Readings for Every Day in Lent,** compiled from the Writings of Bishop JEREMY TAYLOR. By the same. Fcp. 5s.

**Preparation for the Holy Communion; the Devotions chiefly from the works of JEREMY TAYLOR.** By the same. 82mo. 8s.

**Principles of Education drawn from Nature and Revelation, and Applied to Female Education in the Upper Classes.** By the same. 2 vols. fcp. 12s. 6d.

**The Wife's Manual; or, Prayers, Thoughts, and Songs on Several Occasions of a Matron's Life.** By the Rev. W. CALVERT, M.A. Crown 8vo. 10s. 6d.

**Lyra Domestica; Christian Songs for Domestic Edification.** Translated from the *Psalter and Harp* of C. J. P. SPITTA, and from other sources, by RICHARD MASSIE. FIRST and SECOND SERIES, fcp. 4s. 6d. each.

**'Spiritual Songs' for the Sundays and Holidays throughout the Year.** By J. S. B. MONSKELL, LL.D. Vicar of Egham and Rural Dean. Sixth Thousand. Fcp. price 4s. 6d.

**The Beatitudes: Abasement before God: Sorrow for Sin; Meekness of Spirit; Desire for Holiness; Gentleness; Purity of Heart; the Peace-makers; Sufferings for Christ.** By the same Author. Third Edition, revised. Fcp. 3s. 6d.

**His Presence not his Memory, 1855.** By the same Author, in memory of his SON. Fifth Edition. 16mo. 1s.

SERIES, Hymns for the Sundays and Chief Festivals; SECOND SERIES, the Christian Life. Fcp. 8s. 6d. each SERIES.

Hymns from *Lyra Germanica*, 18mo. 1s.

**Lyra Eucharistica**; Hymns and Verses on the Holy Communion, Ancient and Modern; with other Poems. Edited by the Rev. ORBY SHIPLEY, M.A. Second Edition. Fcp. 7s. 6d.

**Lyra Messianica**; Hymns and Verses on the Life of Christ, Ancient and Modern; with other Poems. By the same Editor. Second Edition, enlarged. Fcp. 7s. 6d.

**Lyra Mystica**; Hymns and Verses on Sacred Subjects, Ancient and Modern. By the same Editor. Fcp. 7s. 6d.

Poetry. Edited by the Rev. B. W. SAVILE, M.A. Third Edition, enlarged. Fcp. 5s.

**The Catholic Doctrine of the Atonement**; an Historical Inquiry into its Development in the Church: with an Introduction on the Principle of Theological Developments. By H. N. OXFORD, M.A. 8vo. 8s. 6d.

**Endeavours after the Christian Life**: Discourses. By JAMES MARTINEAU. Fourth and cheaper Edition, carefully revised; the Two Series complete in One Volume. Post 8vo. 7s. 6d.

**Introductory Lessons on the History of Religious Worship**; being a Sequel to the 'Lessons on Christian Evidences.' By RICHARD WHATELY, D.D. New Edition. 18mo. 2s. 6d.

## Travels, Voyages, &c.

**The North-West Peninsula of Iceland**; being the Journal of a Tour in Iceland in the Summer of 1862. By C. W. SHEPHERD, M.A. F.Z.S. With a Map and Two Illustrations. Fcp. 8vo. 7s. 6d.

**Pictures in Tyrol and Elsewhere**. From a Family Sketch-Book. By the Author of 'A Voyage on Zigzag,' &c. Quarto, with numerous Illustrations, 21s.

**How we Spent the Summer**; or, a Voyage on Zigzag in Switzerland and Tyrol with some Members of the ALPINE CLUB. From the Sketch-Book of one of the Party. Third Edition, re-drawn. In oblong 4to. with about 300 Illustrations, 15s.

**Beaten Tracks**; or, Pen and Pencil Sketches in Italy. By the Authoress of 'A Voyage on Zigzag.' With 42 Plates, containing about 200 Sketches from Drawings made on the Spot. 8vo. 16s.

**Florence, the New Capital of Italy**. By C. R. WELD. With several Engravings on Wood, from Drawings by the Author. Post 8vo. 12s. 6d.

**Map of the Chain of Mont Blanc**, from an actual Survey in 1868-1864. By A. ADAMS-REILLY, F.R.G.S. M.A.C. Published under the Authority of the Alpine Club. In Chromolithography on extra stout drawing-paper 28in. x 17in. price 10s. or mounted on canvas in a folding case, 12s. 6d.

**History of Discovery in our Australasian Colonies, Australia, Tasmania, and New Zealand, from the Earliest Date to the Present Day**. By WILLIAM HOWITT. With 8 Maps of the Recent Explorations from Official Sources. 2 vols. 8vo. 20s.

**The Capital of the Tycoon**; a Narrative of a 3 Years' Residence in Japan. By Sir RUTHERFORD ALCOCK, K.C.B. 2 vols. 8vo. with numerous Illustrations, 42s.

**The Dolomite Mountains**. Excursions through Tyrol, Carinthia, Carniola, and Friuli. By J. GILBERT and G. C. CHURCHILL, F.R.G.S. With numerous Illustrations. Square crown 8vo. 21s.

**A Lady's Tour Round Monte Rosa**; including Visits to the Italian Valleys. With Map and Illustrations. Post 8vo. 14s.

**Guide to the Pyrenees**, for the use of Mountaineers. By CHARLES PACKE. With Maps, &c. and Appendix. Fcp. 6s.

**The Alpine Guide**. By JOHN BALL, M.R.I.A. late President of the Alpine Club. Post 8vo. with Maps and other Illustrations.

**Guide to the Eastern Alps**. [Just ready.]

**Guide to the Western Alps**, including Mont Blanc, Monte Rosa, Zermatt, &c. price 7s. 6d.

**Guide to the Oberland and all Switzerland, excepting the Neighbourhood of Monte Rosa and the Great St. Bernard**; with Lombardy and the adjoining portion of Tyrol. 7s. 6d.

**The Englishman in India.** By CHARLES RAIKES, Esq. C.S.I. formerly Commissioner of Lahore. Post 8vo. 7s. 6d.

**The Irish in America.** By JOHN FRANCIS MAGUIRE, M.P. for Cork. Post 8vo. 12s. 6d.

**The Arch of Titus and the Spoils of the Temple;** an Historical and Critical Lecture, with Authentic Illustrations. By WILLIAM KNIGHT, M.A. With 10 Woodcuts from Ancient Remains. 4to. 10s.

**Curiosities of London;** exhibiting the most Rare and Remarkable Objects of Interest in the Metropolis; with nearly Sixty Years' Personal Recollections. By JOHN TIMBS, F.S.A. New Edition, corrected and enlarged. 8vo. Portrait, 21s.

**Narratives of Shipwrecks of the Royal Navy** between 1798 and 1857, compiled from Official Documents in the Admiralty by W. O. S. GILLY; with a Preface by W. S. GILLY, D.D. 8d Edition, fcp. 5s.

**Visits to Remarkable Places:** Old Halls, Battle-Fields, and Scenes illustrative of Striking Passages in English History and Poetry. By WILLIAM HOWITT. 2 vols. square crown 8vo. with Wood Engravings, 25s.

**The Rural Life of England.** By the same Author. With Woodcuts by Bewick and Williams. Medium 8vo. 12s. 6d.

**A Week at the Land's End.** By J. T. BLIGHT; assisted by E. H. RODD, R. Q. COUCH, and J. RALPH. With Map and 96 Woodcuts. Fcp. 6s. 6d.

### Works of Fiction.

**The Warden:** a Novel. By ANTHONY TROLLOPE, Crown 8vo. 2s. 6d.

**Barchester Towers:** a Sequel to 'The Warden.' By the same Author. Crown 8vo. 8s. 6d.

**Stories and Tales by the Author of 'Amy Herbert,'** uniform Edition, each Tale or Story complete in a single volume.

AMY HERBERT, 2s. 6d.	KATHARINE ASUTON, 3s. 6d.
GERTRUDE, 2s. 6d.	MARGARET PERCIVAL, 5s.
EARL'S DAUGHTER, 2s. 6d.	LANETON PARSONAGE, 4s. 6d.
EXPERIENCE OF LIFE, 2s. 6d.	URSULA, 4s. 6d.
CLEVE HALL, 8s. 6d.	
IVORA, 8s. 6d.	

**A Glimpse of the World.** By the Author of 'Amy Herbert.' Fcp. 7s. 6d.

**The Journal of a Home Life.** By the same Author. Post 8vo. 9s. 6d.

**After Life;** a Sequel to the 'Journal of a Home Life.' By the same Author. Post 8vo. [Nearly ready.]

**Gallus;** or, Roman Scenes of the Time of Augustus: with Notes and Excursions illustrative of the Manners and Customs of the Ancient Romans. From the German of Prof. BECKER. New Edit. Post 8vo. 7s. 6d.

**Charicles;** a Tale illustrative of Private Life among the Ancient Greeks: with Notes and Excursions. From the German of Prof. BECKER. New Edition, Post 8vo. 7s. 6d.

**Springdale Abbey:** Extracts from the Letters and Diaries of an ENGLISH PREACHER. 8vo. 12s.

**The Six Sisters of the Valleys:** an Historical Romance. By W. BRAMLEY-MOORE, M.A. Incumbent of Gerrard's Cross, Bucks. Fourth Edition, with 14 Illustrations. Crown 8vo. 5s.

**Tales from Greek Mythology.** By GEORGE W. COX, M.A. late Scholar of Trin. Coll. Oxon. Second Edition. Square 16mo. 8s. 6d.

**Tales of the Gods and Heroes.** By the same Author. Second Edition. Fcp. 5s.

**Tales of Thebes and Argos.** By the same Author. Fcp. 4s. 6d.

**A Manual of Mythology,** in the form of Question and Answer. By the same Author. Fcp. 3s.

**Cabinet Edition of Novels and Tales** by By G. J. WHYTE MELVILLE:—

**The Gladiators:** a Tale of Rome and Judea. Crown 8vo. 5s.

**Digby Grand,** 5s.

**Kate Coventry,** 5s.

**General Bounce,** 5s.

**Holmby House,** 5s.

**Good for Nothing,** 5s.

**The Queen's Maries,** 6s.

**The Interpreter,** a Tale of the War.

## Poetry and The Drama.

- Moore's Poetical Works, Cheapest Editions complete in 1 vol.** including the Autobiographical Prefaces and Author's last Notes, which are still copyright. Crown 8vo. ruby type, with Portrait, 6s. or People's Edition, in larger type, 12s. 6d.
- Moore's Poetical Works, as above, Library Edition, medium 8vo.** with Portrait and Vignette, 14s. or in 10 vols. fcp. 3s. 6d. each.
- Moore's Lalla Rookh, Tenniel's Edition, with 68 Wood Engravings from Original Drawings and other Illustrations.** Fcp. 4to. 21s.
- Moore's Irish Melodies, MacLise's Edition, with 161 Steel Plates from Original Drawings.** Super-royal 8vo. 51s. 6d.
- Miniature Edition of Moore's Irish Melodies, with MacLise's Illustrations, (as above) reduced in Lithography.** Imp. 16mo. 10s. 6d.
- Southey's Poetical Works, with the Author's last Corrections and copyright Additions.** Library Edition, in 1 vol. medium 8vo. with Portrait and Vignette, 14s. or in 10 vols. fcp. 3s. 6d. each.
- Lays of Ancient Rome; with *Ivry* and the *Armada*.** By the Right Hon. LORD MACAULAY. 16mo. 4s. 6d.
- Lord Macaulay's Lays of Ancient Rome.** With 90 Illustrations on Wood, Original and from the Antique, from Drawings by G. SCHARF. Fcp. 4to. 21s.
- Miniature Edition of Lord Macaulay's Lays of Ancient Rome, with Scharf's Illustrations (as above) reduced in Lithography.** Imp. 16mo. 10s. 6d.
- Poems.** By JEAN INGELOW. Twelfth Edition. Fcp. 8vo. 5s.
- Poems by Jean Ingelow.** A New Edition, with nearly 100 Illustrations by Eminent Artists, engraved on Wood by the Brothers DALZIEL. Fcp. 4to. 21s.
- A Story of Doom, and other Poems.** By JEAN INGELOW. Fcp. 6s.
- Poetical Works of Letitia Elizabeth Landon (L.E.L.)** 2 vols. 16mo. 10s.
- Playtime with the Poets: a Selection of the best English Poetry for the use of Children.** By a LADY. Crown 8vo. 5s.
- Memories of some Contemporary Poets; with Selections from their Writings.** By EMILY TAYLOR. Royal 18mo. 5s.
- Bowdler's Family Shakspeare, cheaper Genuine Edition, complete in 1 vol. large type, with 86 Woodcut Illustrations, price 14s. or in 6 pocket vols. 3s. 6d. each.**
- Shakspeare's Sonnets never before Interpreted; his Private Friends identified; together with a recovered Likeness of Himself.** By GERALD MASSEY. 8vo. 18s.
- Arundines Cami, sive Musarum Cantabrigiansium Lusum Canori. Collegit atque edidit H. DEURY, M.A. Editio Sexta, curavit H. J. HODGSON, M.A.** Crown 8vo. price 7s. 6d.
- Horatii Opera, Library Edition, with Copious English Notes, Marginal References and Various Readings.** Edited by the Rev. J. E. YONGE, M.A. 8vo. 21s.
- Eight Comedies of Aristophanes, viz. the Acharnians, Knights, Clouds, Wasps, Peace, Birds, Frogs, and Plutus.** Translated into Rhymed Metres by LEONARD-HAMPTON RUDD, M.A. 8vo. 15s.
- The Æneid of Virgil Translated into English Verse.** By JOHN CONINGTON, M.A. Corpus Professor of Latin in the University of Oxford. Crown 8vo. 9s.
- The Iliad of Homer Translated into Blank Verse.** By ICHABOD CHARLES WRIGHT, M.A. 2 vols. crown 8vo. 21s.
- The Iliad of Homer in English Hexameter Verse.** By J. HENRY DART, M.A. of Exeter College, Oxford. Square crown 8vo. 21s.
- Dante's Divine Comedy, translated in English Terza Rima by JOHN DAYMAN, M.A. [With the Italian Text, after Brunetti, interpaged.]** 8vo. 21s.
- The Holy Child.** A Poem in Four Cantos; also an Ode to Silence, and other Poems. By S. JENNER, M.A. Fcp. 8vo. 5s.
- Poetical Works of John Edmund Reade; with final Revision and Additions.** 3 vols. fcp. 18s. or each vol. separately, 6s.

*Rural Sports, &c.*

- Encyclopædia of Rural Sports ; a Complete Account, Historical, Practical, and Descriptive, of Hunting, Shooting, Fishing, Racing, &c.** By D. P. BLAINE. With above 600 Woodcuts (20 from Designs by JOHN LEECH). 8vo. 42s.
- Col. Hawker's Instructions to Young Sportsmen in all that relates to Guns and Shooting.** Revised by the Author's Son. Square crown 8vo. with Illustrations, 18s.
- The Rifle, its Theory and Practice.** By ARTHUR WALKER (79th Highlanders), Staff, Hythe and Fleetwood Schools of Musketry. Second Edition. Crown 8vo. with 125 Woodcuts, 5s.
- The Dead Shot, or Sportsman's Complete Guide; a Treatise on the Use of the Gun, Dog-breaking, Pigeon-shooting, &c.** By MARKSMAN. Fcp. with Plates, 5s.
- A Book on Angling: being a Complete Treatise on the Art of Angling in every branch, including full Illustrated Lists of Salmon Flies.** By FRANCIS FRANCIS. Second Edition, with Portrait and 16 other Plates, plain and coloured. Post 8vo. 15s.
- Ephemera's Handbook of Angling: Teaching Fly-fishing, Trolling, Bottom-fishing, Salmon-fishing; with the Natural History of River Fish.** Fcp. 5s.
- The Fly-Fisher's Entomology.** By ALFRED RONALDS. With coloured Representations of the Natural and Artificial Insect. Sixth Edition; with 20 coloured Plates. 8vo. 14s.
- Youatt on the Horse.** Revised and enlarged by W. WATSON, M.R.C.V.S. 8vo. with numerous Woodcuts, 12s. 6d.
- Youatt on the Dog.** (By the same Author.) 8vo. with numerous Woodcuts, 6s.
- The Cricket Field; or, the History and the Science of the Game of Cricket.** By JAMES PYCROFT, B.A. 4th Edition. Fcp. 5s.
- The Horse-Trainer's and Sportsman's Guide: with Considerations on the Duties of Grooms, on Purchasing Blood Stock, and on Veterinary Examination.** By DIGBY COLLIER. Post 8vo. 6s.
- Blaine's Veterinary Art: a Treatise on the Anatomy, Physiology, and Curative Treatment of the Diseases of the Horse, Neat Cattle, and Sheep.** Seventh Edition, revised and enlarged by C. STEEL. 8vo. with Plates and Woodcuts, 18s.
- On Drill and Mæuvres of Cavalry, combined with Horse Artillery.** By Major-Gen. MICHAEL W. SMITH, G.B. 8vo. 12s. 6d.
- The Horse's Foot, and how to keep it Sound.** By W. MILES, Esq. 9th Edition, with Illustrations. Imp. 8vo. 12s. 6d.
- A Plain Treatise on Horse-shoeing.** By the same Author. Post 8vo. with Illustrations, 2s. 6d.
- Stables and Stable Fittings.** By the same. Imp. 8vo. with 18 Plates, 15s.
- Remarks on Horses' Teeth, addressed to Purchasers.** By the same. Post 8vo. 1s. 6d.
- The Dog in Health and Disease.** By STONEHENGE. With 70 Wood Engravings. New Edition. Square crown 8vo. 10s. 6d.
- The Greyhound.** By the same Author. Revised Edition, with 24 Portraits of Greyhounds. Square crown 8vo. 21s.
- The Ox, his Diseases and their Treatment; with an Essay on Parturition in the Cow.** By J. R. DONSON, M.R.C.V.S. Crown 8vo. with Illustrations, 7s. 6d.

*Commerce, Navigation, and Mercantile Affairs.*

- Banking, Currency, and the Exchanges: a Practical Treatise.** By ARTHUR CRUMP, Bank Manager, formerly of the Bank of England. Post 8vo. 6s.
- The Elements of Banking.** By HENRY DUNNING MACLEOD, M.A. of Trinity College, Cambridge, and of the Inner Temple, Barrister-at-Law. Post 8vo. [Nearly ready.]
- The Theory and Practice of Banking.** By HENRY DUNNING MACLEOD, M.A. Barrister-at-Law. Second Edition, entirely remodelled. 2 vols. 8vo. 80s.
- A Dictionary, Practical, Theoretical, and Historical, of Commerce and Commercial Navigation.** By J. R. M'CUICHLIN. New Edition in the press.



**Elements of Maritime International Law.** By WILLIAM DE BURGH, B.A. of the Inner Temple, Barrister-at-Law 8vo.

**Papers on Maritime Legislation;** with a Translation of the German Mercantile Law relating to Maritime Commerce. By ERNST EMIL WENDT. 8vo. 10s. 6d.

**Practical Guide for British Shipmasters to United States Ports.** By PIERRE-ROBERT EDWARDS, Her Britannic Majesty's Vice-Consul at New York. Post 8vo. 8s. 6d.

**The Law of Nations Considered as Independent Political Communities.** By TRAVERS TWISS, D.C.L. Regius Professor of Civil Law in the University of Oxford. 2 vols. 8vo. 30s. or separately, PART I. *Peace*, 12s. PART II. *War*, 18s.

**A Nautical Dictionary, defining the Technical Language** relative to the Building and Equipment of Sailing Vessels and Steamers, &c. By ARTHUR YOUNG. Second Edition; with Plates and 150 Woodcuts. 8vo. 18s.

### *Works of Utility and General Information.*

**Modern Cookery for Private Families,** reduced to a System of Easy Practice in a Series of carefully-tested Receipts. By ELIZA ACORN. Newly revised and enlarged; with 8 Plates, Figures, and 150 Woodcuts. Fcp. 6s.

**On Food and its Digestion;** an Introduction to Diætetica. By W. BRINTON, M.D. Physician to St. Thomas's Hospital, &c. With 48 Woodcuts. Post 8vo. 12s.

**Wine, the Vine, and the Cellar.** By THOMAS G. SHAW. Second Edition, revised and enlarged, with Frontispiece and 31 Illustrations on Wood. 8vo 16s.

**A Practical Treatise on Brewing;** with Formulæ for Public Brewers, and Instructions for Private Families. By W. BLACK. Fifth Edition. 8vo. 10s. 6d.

**How to Brew Good Beer:** a complete Guide to the Art of Brewing Ale, Bitter Ale, Table Ale, Brown Stout, Porter, and Table Beer. By JOHN PITT. Revised Edition. Fcp. 4s. 6d.

**The Billiard Book.** By Captain CRAWLEY, Author of 'Billiards, its Theory and Practice,' &c. With nearly 100 Diagrams on Steel and Wood. 8vo. 21s.

**Whist, What to Lead.** By CAM. Third Edition. 32mo. 1s.

**The Cabinet Lawyer;** a Popular Digest of the Laws of England, Civil, Criminal, and Constitutional. 23rd Edition, entirely recomposed, and brought down by the AUTHOR to the close of the Parliamentary Session of 1867. Fcp. 10s. 6d.

**The Philosophy of Health;** or, an Exposition of the Physiological and Sanitary Conditions conducive to Human Longevity and Happiness. By SOUTHWOOD SMITH, M.D. Eleventh Edition, revised and enlarged; with 118 Woodcuts. 8vo. 7s. 6d.

**A Handbook for Readers at the British Museum.** By THOMAS NICHOLS. Post 8vo. 6s.

**Hints to Mothers on the Management of their Health** during the Period of Pregnancy and in the Lying-in Room. By T. BULL, M.D. Fcp. 5s.

**The Maternal Management of Children in Health and Disease.** By the same Author. Fcp. 5s.

**Notes on Hospitals.** By FLORENCE NIGHTINGALE. Third Edition, enlarged; with 13 Plans. Post 4to. 18s.

**The Executor's Guide.** By J. C. HUDSON. Enlarged Edition, revised by the Author, with reference to the latest reported Cases and Acts of Parliament. Fcp. 6s.

**The Law relating to Benefit Building Societies;** with Practical Observations on the Act and all the Cases decided thereon, also a Form of Rules and Forms of Mortgages. By W. TIDD PRATT, Barrister. 2nd Edition. Fcp. 8s. 6d.

**Willich's Popular Tables** for Ascertaining the Value of Lifehold, Leasehold, and Church Property, Renewal Fines, &c.; the Public Funds; Annual Average Price and Interest on Consols from 1781 to 1861; Chemical, Geographical, Astronomical, Trigonometrical Tables, &c. Post 8vo. 10s.

**Decimal Interest Tables at Twenty-four Different Rates** not exceeding Five per Cent. Calculated for the use of Bankers. To which are added Commission Tables at One-eighth and One-fourth per Cent. By J. R. COULTEART. New Edition. 8vo. 15s.

**Maunder's Treasury of Knowledge and Library of Reference:** comprising an English Dictionary and Grammar, Universal Gazetteer, Classical Dictionary, Chronology, Law Dictionary, Synopsis of the Peerage, useful Tables, &c. Fcp. 10s. 6d.

# I N D E X.

ACTON'S Modern Cookery.....	20	BUNSEN (E. De) on Apocrypha.....	15
ALCOCK'S Residence in Japan.....	16	—————'s Keys of St. Peter.....	15
ALLIES on Formation of Christianity.....	15	BURKE'S Vicissitudes of Families.....	4
Alpine Guide (The).....	16	BURTON'S Christian Church.....	3
ALVENSLEBEN'S Maximilian in Mexico.....	4	Cabinet Lawyer.....	20
APJOHN'S Manual of the Metalloids.....	9	CALVERT'S Wife's Manual.....	15
ARNOLD'S Manual of English Literature.....	5	CATES'S Biographical Dictionary.....	3
ARNOTT'S Elements of Physics.....	8	CATS and FARLIE'S Moral Emblems.....	12
Arundines Cami.....	18	Chorale Book for England.....	11
Autumn Holidays of a Country Parson.....	6	Christian Schools and Scholars.....	6
AYRE'S Treasury of Bible Knowledge.....	14	CLOUGH'S Lives from Plutarch.....	2
BACON'S Essays by WHATELY.....	5	COLENSO (Bishop) on Pentateuch and Book of Joshua.....	15
————— Life and Letters, by SPEDDING.....	3	COLLINS'S Horse Trainer's Guide.....	19
————— Works.....	4	Commonplace Philosopher in Town and Country.....	6
BAIN on the Emotions and Will.....	7	CONINGTON'S Chemical Analysis.....	10
————— on the Senses and Intellect.....	7	————— Translation of Virgil's <i>Æneid</i> .....	18
————— on the Study of Character.....	7	CONTANSEAU'S Two French and English Dictionaries.....	6
BALL'S Guide to the Central Alps.....	16	CONYBEARE and HOWSON'S Life and Epistles of St. Paul.....	14
————— Guide to the Western Alps.....	16	COOK'S Acts of the Apostles.....	14
————— Guide to the Eastern Alps.....	16	COPLAND'S Dictionary of Practical Medicine.....	11
BARNEAD'S Drawing from Nature.....	12	COULTHART'S Decimal Interest Tables.....	20
BAYLTON'S Rents and Tillages.....	13	COX'S Manual of Mythology.....	17
Beaten Tracks.....	16	————— Tales of the Great Persian War.....	2
BECKER'S <i>Charicles</i> and <i>Gallus</i> .....	17	————— Tales from Greek Mythology.....	17
BETHOVEN'S Letters.....	4	————— Tales of the Gods and Heroes.....	17
BENFET'S Sanskrit-English Dictionary.....	6	————— Tales of Thebes and Argos.....	17
BERRY'S Journals.....	3	CRAWLEY'S Billiard Book.....	20
BLACK'S Treatise on Brewing.....	20	CRESTY'S Encyclopedia of Civil Engineering.....	13
BLACKLEY and FRIEDLANDER'S German and English Dictionary.....	6	Critical Essays of a Country Parson.....	6
BLAINE'S Rural Sports.....	19	CROWE'S History of France.....	3
————— Veterinary Art.....	19	CRUMP on Banking, &c.....	19
BLIGHT'S Week at the Land's End.....	7	CUSSAN'S Grammar of Heraldry.....	12
BOOTH'S Epigrams.....	6	DART'S Iliad of Homer.....	18
BOURNE on Screw Propeller.....	13	D'AUBIGNÉ'S History of the Reformation in the time of CALVIN.....	2
————— Catechism of the Steam Engine.....	13	DAVIDSON'S Introduction to New Testament.....	14
————— Handbook of Steam Engine.....	13	DAYMAN'S Dante's Divina Commedia.....	18
————— Treatise on the Steam Engine.....	13	Dead Shot (The), by MARKSMAN.....	19
BOWDLER'S Family SHAKESPEARE.....	18	DE BURGH'S Maritime International Law.....	20
BRAMLEY-MOORE'S Six Sisters of the Valleys.....	17	DE LA RIVE'S Treatise on Electricity.....	8
BRANDE'S Dictionary of Science, Literature, and Art.....	10	DE MORGAN on Matter and Spirit.....	7
BRAY'S (C.) Education of the Feelings.....	7	DE TOCQUEVILLE'S Democracy in America.....	3
————— Philo-sophy of Necessity.....	7	DIRRAHL'S Speeches on Reform.....	5
————— On Force.....	7	DOBSON on the Ox.....	19
BRINTON on Food and Digestion.....	20	DOVE on Storms.....	8
BRISTOW'S Glossary of Mineralogy.....	8	DYER'S City of Rome.....	2
BRODIE'S Constitutional History.....	1	EASTLAKE'S Hints on Household Taste.....	13
————— (Sir C. B.) Works.....	11	EDWARDS'S Shipmaster's Guide.....	20
BROWNE'S Exposition 39 Articles.....	14	Elements of Botany.....	9
BUCKLE'S History of Civilisation.....	2		
BULL'S Hints to Mothers.....	20		
————— Maternal Management of Children.....	20		
BUNSEN'S Ancient Egypt.....	3		
————— God in History.....	3		
————— Memoirs.....	3		



ELLIOTT's Commentary on Ephesians .....	14	HORSLEY's Manual of Poisons .....	9
Destiny of the Creature .....	14	HOSKINS's Occasional Essays.....	7
Lectures on Life of Christ .....	14	How we Spent the Summer.....	16
Commentary on Galatians .....	14	HOWARD's Gymnastic Exercises .....	11
Pastoral Epist. ....	14	HOWITT's Australian Discovery.....	16
Philippians, &c. ....	14	Rural Life of England .....	17
Thessalonians .....	14	Visits to Remarkable Places .....	17
ENGL'S Introduction to National Music ..	11	HUDSON's Executor's Guide .....	20
Essays and Reviews .....	15	HUGHES's Garden Architecture .....	13
on Religion and Literature, edited by		(W.) Manual of Geography .....	7
MANNING, FIRST and SECOND SERIES ..	15	HULLAR's History of Modern Music .....	11
EWALD's History of Israel .....	14	Transition Musical Lectures .....	11
		Sacred Music .....	11
FAIRBAIRN's Application of Cast and		HUMPHREYS's Sentiments of Shakspeare ..	13
Wrought Iron to Building .....	13	HUTTON's Studies in Parliament .....	6
Information for Engineers .....	13	Hymns from <i>Lyra Germanica</i> .....	14
Treatise on Mills and Millwork .....	13		
FAIRBAIRN on Iron Shipbuilding .....	13	INGELOW's Poems .....	18
FARRAR's Chapters on Language .....	5	Story of Doom .....	18
FELKIN on Hosiery & Lace Manufactures..	13	Icelandic Legends, SECOND SERIES .....	17
FFOULKE's Christendom's Divisions .....	15		
FLIKDNER's (Pastor) Life .....	4	JAMESON's Legends of the Saints and Mar-	
FRANCIS's Fishing Book .....	19	tyrs .....	12
(Sir P.) Memoir and Journal .....	5	Legends of the Madonna .....	12
FROUDE's History of England .....	1	Legends of the Monastic Orders .....	12
Short Studies .....	6	JAMESON and EASTLAKE's History of Our	
		Lord .....	12
GANOT's Elementary Physics .....	8	JENNER's Holy Child .....	18
GILBERT and CHURCHILL's Dolomite Moun-		JOHNSTON's Gazetteer, or General Geo-	
tains .....	16	graphical Dictionary .....	7
GILL's Papal Drama .....	2		
GILLY's Shipwrecks of the Navy .....	17	KALISON's Commentary on the Bible.....	5
GOODEVE's Elements of Mechanism.....	13	Hebrew Grammar.....	5
GORLE's Questions on BROWN's Exposition		KEITH on Destiny of the World.....	14
of the 39 Articles .....	14	Fulfillment of Prophecy.....	14
GRANT's Ethics of Aristotle.....	4	KELLER's Lake Dwellings of Switzerland ..	9
GRAVER Thoughts of a Country Parson.....	6	KRESTER's Domestic Medicine .....	11
GRAY's Anatomy.....	11	KIRBY and SPENCE's Entomology .....	9
GREENE's Corals and Sea Jellies .....	9	KNIGHT's Arch of Titus.....	17
Sponges and Animalcules.....	9		
GROVE on Correlation of Physical Forces ..	8	Lady's Tour round Monte Rosa .....	16
GWILT's Encyclopaedia of Architecture .....	12	LARDON's (L. E. L.) Poetical Works .....	18
		LATHAM's English Dictionary .....	5
Handbook of Angling, by SPHINXER.....	19	River Plate.....	7
Hare on Election of Representatives .....	5	LAWRENCE on Rocks .....	8
HARLEY and BROWN's Histological Demon-		LECKY's History of Rationalism .....	2
strations .....	11	Leisure Hours in Town .....	6
HARTWIG's Harmonies of Nature.....	9	Lessons of Middle Age .....	6
Polar World .....	9	Letters of Distinguished Musicians .....	4
Sea and its Living Wonders.....	9	LEWES's Biographical History of Philosophy	
Tropical World.....	9	LIDDELL and SCOTT's Greek-English Lexicon	
HAUGHTON's Manual of Geology .....	8	Abridged ditto .....	6
HAWKER's Instructions to Young Sports-		Life of Man Symbolised .....	12
men .....	19	LINDLEY and MOORE's Treasury of Botany ..	9
HEARN's Ptology .....	2	LONGMAN's Lectures on History of England ..	2
on English Government .....	2	LOUDON's Encyclopaedia of Agriculture .....	12
HELPS's Spanish Conquest in America .....	2	Gardening .....	13
HENDERSON's Folk-Lore .....	6	Plants .....	9
HENSCHEL's Essays from Reviews .....	10	Trees and Shrubs .....	9
Outlines of Astronomy.....	7	Cottage, Farm, and Villa Architecture ..	12
Preliminary Discourse on the		LOWNDEN's Engineer's Handbook.....	12
Study of Natural Philosophy .....	8	Lyra Domestica.....	12
HEWITT on the Diseases of Women .....	10	Eucharistica .....	16
HODGSON's Time and Space .....	7	Germanica .....	12, 16
HOLMES's System of Surgery .....	10	Mecanica .....	16
HOOKER and WALKER-ARNOTT's British		Mystica .....	16
Flora .....	9	Sacra .....	16
HOPKIN's Hawaii .....	8	MACAULAY's (Lord) Essays.....	2
HORN'S Introduction to the Scriptures ..	14		
Compendium of the Scriptures ..	14		

Miscellaneous Writings.....	6
Speeches.....	8
Works.....	1
MACFARREN'S Lectures on Harmony.....	11
MACLEOD'S Elements of Political Economy.....	4
Dictionary of Political Economy.....	4
Elements of Banking.....	19
Theory and Practice of Banking.....	19
MCCULLOCH'S Dictionary of Commerce.....	19
Geographical Dictionary.....	7
MAGUIRE'S Irish in America.....	17
Life of Father Mathew.....	3
Rome and its Rulers.....	3
MALLESON'S French in India.....	2
MANNING on Holy Ghost.....	15
England and Christendom.....	15
MARSHALL'S Physiology.....	10
MARSHMAN'S History of India.....	2
Life of Havelock.....	4
MARTINEAU'S Endeavours after the Christian Life.....	18
MASSEY on Shakespeare's Sonnets.....	18
History of England.....	1
MASINGBERD'S History of the Reformation.....	3
MAUNDER'S Biographical Treasury.....	4
Geographical Treasury.....	8
Historical Treasury.....	3
Scientific and Literary Treasury.....	9
Treasury of Knowledge.....	20
Treasury of Natural History.....	9
MAURY'S Physical Geography.....	8
MAY'S Constitutional History of England.....	1
MELVILLE'S Digby Grand.....	17
General Bounce.....	17
Gladiators.....	17
Good for Nothing.....	17
Holmby House.....	17
Interpreter.....	17
Kate Coventry.....	17
Queen's Maries.....	17
MENDELSSOHN'S Letters.....	4
MERIVALE'S (H.) Historical Studies.....	1
(C.) Fall of the Roman Republic.....	2
Romans under the Empire.....	2
Boyle Lectures.....	2
MILES on Horse's Foot and Horse Shoeing.....	19
on Horses' Teeth and Stables.....	19
MILL on Liberty.....	4
on Representative Government.....	4
on Utilitarianism.....	4
's Dissertations and Discussions.....	4
Political Economy.....	4
System of Logic.....	4
Hamilton's Philosophy.....	4
Inaugural Address at St. Andrew's.....	5
MILLER'S Elements of Chemistry.....	10
MITCHELL'S Manual of Assaying.....	13
MONSELL'S Bestitudes.....	15
His Presence not his Memory.....	15
'Spiritual Songs'.....	15
MONTGOMERY on Pregnancy.....	10
MOORE'S Irish Melodies.....	18
Lalla Rookh.....	18
Journal and Correspondence.....	3
Poetical Works.....	18
(Dr. G.) First Man.....	8
MORELL'S Elements of Psychology.....	7
Mental Philoosophy.....	7
MORRIS'S Ecclesiastical History.....	15

Workshop.....	6
Lectures on the Science of Iguage.....	1
(K. O.) Literature of Ancient Greece.....	1
MURKISON on Continued Fevers.....	19
MURK'S Language and Literature of Greece.....	19
New Testament Illustrated with Woodgravings from the Old Masters.....	19
NEWMAN'S History of his Religious Opinions.....	19
NICHOLAS'S Pedigree of the English People.....	19
NICHOLS'S Handbook to British Museum.....	19
NIGHTINGALE'S Notes on Hospitals.....	19
NILSSON'S Scandinavia.....	19
ODLING'S Animal Chemistry.....	19
Course of Practical Chemistry.....	19
Manual of Chemistry.....	19
Original Designs for Wood Carving.....	19
OWEN'S Comparative Anatomy and Physiology of Vertebrate Animals.....	19
OWEN'S Lectures on the Invertebrates.....	19
OXENHAM on Atonement.....	19
PACKER'S Guide to the Pyrenees.....	19
PAGET'S Lectures on Surgical Pathology.....	19
PERRIERA'S Manual of Materia Medica.....	19
PERKINS'S Tuscan Sculptors.....	19
PHILLIPS'S Guide to Geology.....	19
Pictures in Tyrol.....	19
PIESSE'S Art of Perfumery.....	19
Chemical, Natural, and Physical Medicine.....	19
PIKE'S English and their Origin.....	19
PITT on Brewing.....	19
Playtime with the Poets.....	19
PRATT'S Law of Building Societies.....	19
PRESCOTT'S Scripture Difficulties.....	19
PROCTOR'S Handbook of the Stars.....	19
Saturn.....	19
PYCROFT'S Course of English Reading.....	19
Cricket Field.....	19
RAIKES'S Englishman in India.....	19
RAYMOND on Fishing without Cruelty.....	19
READ'S Poetical Works.....	19
Recreations of a Country Parson.....	19
REILLY'S Map of Mont Blanc.....	19
RIVERS'S Rose Amateur's Guide.....	19
ROGERS'S Correspondence of Grayson.....	19
Eclipse of Faith.....	19
Defence of Faith.....	19
Essays from the Edinburgh Review.....	19
Reason and Faith.....	19
ROGET'S Thesaurus of English Words and Phrases.....	19
RONALD'S Fly-Fisher's Entomology.....	19
ROWTON'S Debater.....	19
RUDD'S Aristophanes.....	19
RUSSELL on Government and Constitution.....	19
SANDERS'S Justinian's Institutes.....	19
SCHUBERT'S Life, translated by COLERIDGE.....	19
SCOTT'S Lectures on the Fine Arts.....	19
SERBOHM'S Oxford Reformers of 1498.....	19
SEWELL'S After Life.....	19
Glimpse of the World.....	19
History of the Early Church.....	19
Journal of a Home Life.....	19

SEWELL's Passing Thoughts on Religion ..	15	TROLLOPE's Barchester Towers .....	17
Preparation for Communion .....	15	Warden .....	17
Principles of Education .....	15	TRISS's Law of Nations .....	20
Readings for Confirmation .....	15	TYNDALL's Lectures on Heat .....	8
Readings for Lent .....	13	Lectures on Sound .....	8
Examination for Confirmation ..	15	Memoir of PARADAY .....	4
Stories and Tales (LONGMANS) ..	17		
SHAW's Work on Wine .....	20	URE's Dictionary of Arts, Manufactures, and	
SHEPHERD's Iceland .....	16	Mines .....	13
SHIPLEY's Church and the World .....	15		
Tracts for the Day .....	15	VAN DER HORVEN's Handbook of Zoology ..	8
Short Whist .....	19	VAUGHAN's (R.) Revolutions in English	
SHORT's Church History .....	3	History .....	1
SMITH's (SOUTHWOOD) Philosophy of Health	20	— Way to Rest .....	7
(J.) Paul's Voyage and Shipwreck	14		
(G.) Reign of King David .....	14	WALKER on the Rifle .....	19
Wesleyan Methodism .....	3	WARD's Workmen and Wages .....	4
(SYDNEY) Miscellaneous Works ..	6	WATSON's Principles and Practice of Physic	10
Moral Philosophy .....	6	WATTS's Dictionary of Chemistry .....	10
Wit and Wisdom .....	6	WEBB's Objects for Common Telescopes ..	7
SMITH on Cavalry Drill and Manœuvres ..	19	WEBSTER & WILKINSON's Greek Testament	13
SOUTHEY's (Doctor) .....	5	WELD's Florence .....	16
Poetical Works .....	18	WELLINGTON's Life, by GLEIG .....	3
Springdale Abbey .....	17	WELLS on Dew .....	8
STANLEY's History of British Birds .....	9	WENDT's Papers on Maritime Law .....	20
STEEBING's Analysis of MILL's Logic .....	5	WEST on Children's Diseases .....	10
STEPHEN's Essays in Ecclesiastical Bio-		WHATELY's English Synonymes .....	5
graphy .....	4	Life and Correspondence .....	3
Lectures on History of France	3	Logic .....	5
STIRLING's Secret of Hegel .....	7	Rhetoric .....	5
STOFFENGE on the Dog .....	19	on Religious Worship .....	16
on the Greyhound .....	19	Whist, what to Lead, by CAM .....	20
STRANGE on Sea Air .....	11	WHITE and RIDDLE's Latin-English Dic-	
Restoration of Health .....	11	tionaries .....	5
Sunday Afternoons at the Parish Church ..	6	WILLICH's Popular Tables .....	20
		WINSLOW on Light .....	8
TAYLOR's (Jeremy) Works, edited by EDEN	15	WOOD's Bible Animals .....	9
(E.), Selections from some Con-		Homes without Hands .....	9
temporary Poets .....	18	WOODWARD's Historical and Chronological	
TENNENT's Ceylon .....	9	Encyclopædia .....	3
Wild Elephant .....	9	WRIGHT's Homer's Iliad .....	18
THIRLWALL's History of Greece .....	2		
TIMBS's Curiosities of London .....	17	YONGE's English-Greek Lexicon .....	5
THOMSON's (Archbishop) Laws of Thought	5	Abridged ditto .....	5
(A. T.) Conspectus .....	11	Horace .....	18
TODD (A.) on Parliamentary Government ..	1	YOUNG's Nautical Dictionary .....	20
—'s Cyclopædia of Anatomy and Physio-		YUWATT on the Dog .....	19
logy .....	11	on the Horse .....	19
and BOWMAN's Anatomy and Physio-			
logy of Man .....	11		

[www.libtool.com.cn](http://www.libtool.com.cn)

[www.libtool.com.cn](http://www.libtool.com.cn)

This book should be returned to  
the Library on or before the last date  
stamped below.

A fine of five cents a day is incurred  
by retaining it beyond the specified  
time.

Please return promptly.



3 2044 091 983 684

[www.libtool.com.cn](http://www.libtool.com.cn)