

www.libtool.com.cn

WIRE
ITS MANUFACTURE AND USES
—
BUCKNALL SMITH

BULLIVANT & CO.

www.libtool.com.cn

— INVENTORS AND MANUFACTURERS OF — PATENT FLEXIBLE STEEL WIRE ROPE

AS USED IN THE ERECTION OF

TAY

(

W

Cornell University Library

BOUGHT WITH THE INCOME
FROM THE
SAGE ENDOWMENT FUND
THE GIFT OF
Henry W. Sage
1891

A. 38.355 *M/21/92*

ES.

S

ON ALL SYSTEMS.

MINING & HAULING PLANT.

PATENT FLEXIBLE STEEL WIRE ROPE

FOR

CRANES, LIFTS, & HOISTS.

BULLIVANT & COMPANY,

Chief Office: 72, Mark Lane, LONDON, E.C.

Works: Millwall, LONDON, E.

Cornell University Library
TS 270.S66

A treatise upon wire, its manufacture and



3 1924 004 438 796

engr

www.libtool.com.cn

THE WHITECROSS CO.

www.libtool.com.cn

(LIMITED)

Forges and Rolling Mills.

**IRON & STEEL ROD ROLLERS,
WIRE DRAWERS,
WIRE ROPE MAKERS,
WIRE NETTING WEAVERS,
WIRE NAIL MAKERS,
GALVANISERS.**

SPECIALITIES:

Low-Resistance TELEGRAPH and TELEPHONE WIRES

AS SUPPLIED TO THE LEADING SPECIFICATIONS.

All Material used in the Company's manufactures prepared and finished by themselves within their own Works.

OFFICES AND WORKS - WARRINGTON.

COLLIERIES - ST. HELEN'S.

LONDON OFFICE - 2, KING WILLIAM ST., E.C.

www.libtool.com.cn

A TREATISE
UPON
WIRE, ITS MANUFACTURE AND USES.

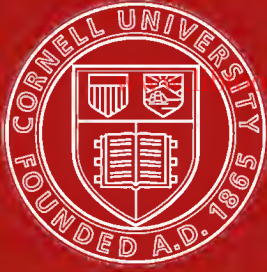

Cornell University Library

The original of this book is in
the Cornell University Library.

There are no known copyright restrictions in
the United States on the use of the text.

<http://www.archive.org/details/cu31924004438796>

A TREATISE

www.libtool.com.cn UPON

WIRE,

ITS

MANUFACTURE AND USES,

EMBRACING

COMPREHENSIVE DESCRIPTIONS OF THE CONSTRUCTIONS
AND APPLICATIONS OF WIRE ROPES.

BY

J. BUCKNALL SMITH, C.E.

AUTHOR OF "CABLE TRACTION, AS APPLIED TO THE WORKING OF RAIL AND TRAMWAYS," "ROPE
HAULAGE IN MINES," "THE DIAMOND MINING INDUSTRY OF SOUTH AFRICA," &c.

*(Late Constructing Engineer to the Patent Cable Tramways Corporation and the Steep
Grade Tramway Company, Highgate, &c., &c.)*

OFFICES OF "ENGINEERING," LONDON ;

AND

JOHN WILEY & SONS, NEW YORK.

1891.



www.libtool.com.cn

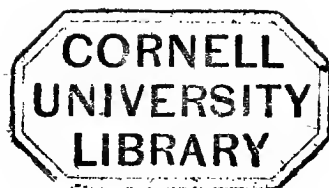

PREFACE.

THIS Treatise is intended to convey to the average reader intelligible and practical descriptions of the history, manufacture, and uses of various kinds of plain and worked wire as occurrent in, or applicable to, innumerable industries and purposes of daily service to all classes of the community. Upon perusing the Synopsis of Contents, it will be apparent that each chapter relating to branches of the art or kindred matters, alone affords ample material for a separate work capable of occupying the available limits of this volume. The present treatise is therefore submitted as an elementary international dissertation, as reasonably exhaustive as the comprehensive nature of the title will permit.

As the production and manipulation of wire are mainly recognised under the style of "trade," it has been endeavoured to treat the subject at issue with a practical subordination of commercial considerations involved. Costs of manufacturing and values of products, &c., have, however, been generally disregarded, owing to the wide and rapid fluctuations which occur in the prices of materials, &c., implicated in the industries described.

The writer is not aware of the existence of any other treatise upon the subject on similar lines to

www.libtool.com.cn
the present effort, although some fragmentary contributions have appeared in the form of papers, presented to societies, and articles in technical and trade journals. The substance of the present work is, however, largely based upon personal experiences, investigations and observations made by the author in various parts of the globe.

Many leading home and foreign manufacturers in the different departments of the industry, are impartially referred to, so that where information has been necessarily curtailed, or deemed advisable to omit, the interested reader may pursue his inquiries or studies in competent channels.

It is therefore hoped that some instructive and useful particulars may be gleaned from the following pages by those interested or engaged in the technical and commercial applications of wire or its products.

A few lines will now be devoted to the general plan of the treatise, after which some comments will be appended upon matters of interest which have transpired, or have come under the writer's notice, since the work has passed through the press.

Considerable care and trouble has been bestowed upon the collection of the historical, and other data, given in the treatise, and in obtaining reliable confirmation as far as possible.

Upon perusing the Introduction, it is believed the reader will concur that sufficient has been written to demonstrate to a wide community some of the many serviceable applications of wire, and did space permit, the examples might be almost indefinitely extended.

To some, the title "Wire" may at first convey

insignificant associations, but upon brief acquaintance with the subject and reflection, it will doubtless be admitted that the chemical, physical, mechanical, and electrical considerations involved in the embodied industries, are almost as extensive and important as the applications of the manufactured products themselves.

The antiquity and history of the craft at issue are alone of prominent interest amongst the records of the early arts and manufactures, as also are its developments which have occurred with the progress of civilisation and mental culture.

Again, the physical considerations concerned in the properties of ductility and tenacity peculiar to different metals, and upon which their comparative "drawing" efficiencies depend, embody worthy material for instructive reflection.

Wire, composed of iron and steel, and described in the first Chapter, will be found to afford manifold opportunities for technical deliberations, whether in the chemistry of the billets, the molecular or physical changes which occur in the metal or its alloy during hot-rolling, cold-drawing, annealing, hardening, and tempering, &c., or in the mechanical arrangements or appliances employed in the manufacture.

Nearly half a century has passed away since the introduction of cast-steel wire, and which still marks a most important period in the career of the industry. Now, by proper selection, treatment, and manipulation, cast-steel wire is daily produced which has fully three times the tensile resistance of any other known form of steel, whilst the degrees of elasticity

www.libtool.com.cn
may extend to within some 75 per cent. of its ultimate strength. These and other extraordinary combined and unique properties have, from time to time, engaged the serious attentions of eminent physicists, chemists, and engineers, both at home and abroad. The serviceable applications of iron and steel wire are alone practically innumerable.

In the succeeding Chapter descriptions are given of the manufacture and uses of the more delicate productions in copper, bronze, brass, platinum, and other precious metals, some of which are to be met with in degrees of fineness which rival any human hair. The beautiful and economical manufacture of silver-gilt wire and its ornamental applications here afford a further interesting example of dexterous manipulation and utility.

The third Chapter deals briefly with gauges, past and present, for measuring the diameters or sizes of wire, and to which all readers practically interested in the industries at issue should bestow some earnest attention. The ambiguity or confusion resulting from the use of old or obsolete gauges has been the cause of many costly and vexatious disputes, and for which, since the inauguration of the Imperial or Legal Standard, there are no valid excuses.

The following Chapter upon electrical conductors, only deals with bare or uninsulated wires, and is necessarily of a brief and elementary character. The greater purity, and consequent better conductivity of copper, obtainable of recent years, is here referred to, whilst passing attention is directed to the manufacture and applications of hard-drawn copper and

silicium-bronze wires. Mattheissen's well-known standard of electrical conductivity, supplemented by the able researches of T. C. Fitzpatrick, are also cursorily approached. Galvanised iron and steel wire for postal and railway telegraph purposes, then receive some share of attention consistent with the determined limits of the work.

The first two Chapters of the second section of this volume are devoted to somewhat exhaustive descriptions of the history, manufacture, and serviceable employments of wire ropes, and which it is hoped will be found acceptable to some class of readers. Practically all the different constructions or types of roping commercially known in Europe and America are explained and illustrated, and these are followed by some examples of the numerous substantial services rendered us by their daily use.

Many of the exemplifications here submitted are the results of personal experiences or investigations made by the writer in diverse parts of the world. Readers desirous of gleaning more exhaustive particulars concerning the countless applications of wire roping, may perhaps be assisted in their object by reference to different articles published by the author in the columns of *Engineering* during 1887 and 1888, *The Colliery Guardian* in 1887, *The Mining Journal* in 1888, and *The Engineer* in 1889.

The two concluding chapters of the treatise relate to the manufacture and utilities of wire netting and woven fabrics, &c., and fencing

www.libtool.com.cn
materials, with their necessary adjuncts, &c., and it is hoped will be found to incorporate matters of agricultural and commercial interest.

Since the treatise has passed through the press, the author is indebted to the editor of *The Electrician* for directing his attention to the question of the comparative efficiency of stranded electrical conductors, a matter that appears to have largely escaped the notice of electricians and engineers, and concerning which correspondence appeared in the following numbers of the journal mentioned: Vol. XXVI., January 23rd, 30th, and February 6th. Upon reflection it will be evident that the electrical conductivity of wires laid into strands, is not directly proportional to that presented by solid straight conductors, firstly, because the contact of the wires is more or less imperfect, and secondly on account of the component wires being laid in a spiral or helical form.

Reverting to Chapter III. on "Wire Gauges," it may be mentioned that Mr. A. P. Trotter has recently published in *The Electrician* (Vol. XXIV., page 8), an able article and diagram concerning the ambiguity and variation of obsolete gauges still sometimes unnecessarily quoted and used in the electrical industries.

Referring to Messrs. Glover & Co.'s table of particulars, *re* copper conductors, given on the folding sheet opposite page 150, it may be of interest to some to know that Mr. W. S. Boulton, of Liverpool, has recently issued a series of comprehensive international tabulations, giving the sizes, areas, weights,

current densities and resistances, &c., of electrical wires.

Towards the close of last month a Paper was read on "Wire Ropes," by one of Her Majesty's Inspectors of Mines, before a Midland Society of Engineers, and which, according to a report given of the same in one of our leading industrial journals on the 27th of March, appears to embody some egregious mistakes. The author of the Paper in question is reported to have advanced that wire ropes "are divided into three great classes, viz., iron, steel, and plough steel," the average breaking strengths of which are given as "20, 35, and 50 tons respectively, per square inch of sectional area." These alleged ultimate tensile resistances of the materials specified are erroneous, hence some deductions following are misleading. The average quality of mining rope wire is composed of "improved cast steel wire," of about 80 tons resistance, whereas "plough steel" usually ranges from 100 to 120 tons quality, and as defined and explained on pages 42, 58, 174, and 214 of this volume. Again the statement, "steel wire should withstand twenty-eight twists," conveys nothing tangible. To those practically acquainted with the subject, the questions naturally present themselves, to steel wire of what quality, temper, gauge, and length does this remark refer? However, with regard to broad averages in mining practices, the torsional efficiency of the wire might be about double that above mentioned, and as will be better understood upon reference to pages 68, 81, 209, and 214 of this treatise.

Further, the method advocated for ascertaining

the ultimate tensile strengths of rope wire, and consisting in the attachment "of a tub at the lower end" of a piece to be tested, and into which water is steadily poured until the wire ruptures, does not appear to be a practical or convenient arrangement. The examples of steel mining rope wire given on page 68 of this treatise are average qualities for the construction of running ropes of from about 2 to 3 in. in circumference, and it will be seen that some of these individual or component wires will withstand a strain of fully 1200 lb. The average diameters of these wires range between 14 and 15 S.W.G., and which sizes will be understood upon reference to the Table and diagram given on pages 72 and 73 respectively. Now take a winding rope, say 4 in. in circumference, composed of larger sized wires (say of Nos. 11 or 12 S.W.G.) of plough steel, and we shall find it is quite feasible to encounter individual wires which may take fully a ton to break them, *i.e.*, say, 2500 lb. Therefore the capacity of a hogshead (54 gallons or 540 lb.) or even a butt (108 gallons, 17.3 cubic ft., or 1080 lb.) would not be equal to the possible requirements even if they were the most convenient things in the world to handle. The tensile testing machines illustrated on pages 77 and 80, &c., are capable of exerting a strain equal to from, say, 30 cwt. to 2 tons on the specimen. When the breaking strain of any wire has been ascertained, the proportion that it bears to tons per square inch of sectional area may be readily calculated by the Table given on page 76 of this volume.

It is admissible that however careful an author

may be, errata and discrepancies do sometimes creep into a work, but one hardly expects to find the accuracy of accepted fundamental principles overlooked.

Since the remarks were written concerning the probable federation of the Australian Colonies, on page 222, the "Constitution of the Commonwealth" has finally passed the Session; let us hope that the next measure to be adopted will be some arrangement for a special rate of Imperial duties for supporting our own manufacturers and for facilitating a preferential commercial reciprocation with the mother country.

In conclusion the author has pleasure in acknowledging the valuable assistance he has received from numerous leading manufacturers and others both at home and abroad, and in mentioning that comments or criticisms made concerning any considerations at issue are impartially and courteously intended.

J. BUCKNALL SMITH.

London, April, 1891.

www.libtool.com.cn

SYNOPSIS OF CONTENTS.

INTRODUCTORY.

	PAGE
Antiquity of Wire Manufactures—Early Egyptian Productions—Wire Relics from Herculaneum, &c., Wiredrawing, Its Invention and Origin—Early Wiredrawing Processes in Germany and France, and Introduction of the Industry into Great Britain—First Mill in England—Hand and Machine Drawn Wire—Lancashire and Yorkshire Industries—Early Manufacturers of Wire in Britain, Europe, and America—Descriptions and Uses of Various Kinds of Wire—Electrical Applications—Wire Ropes and their Services—Wire Netting, Gauze, Cloth, and Cords—Lines in Scientific Instruments—Platinum and Silver Wires—Pin-Making Industry—The Manufacture of Needles, Fish and Crochet Hooks, Umbrella and Spectacle Frames, &c., with Dates of their Invention, &c.—Wire Springs, Spindles, and Pinions used in the Watchmaking Trade—Wire Cycle Spokes, Nails, and Music Strings, &c.—Wire and its Functions in Pianos—Wire-Walkers and Aerial Wires—Silver and Silver Gilt Wires Used for the Production of Filigrees, Laces, Embroideries, and Spangles, &c.—Lightning Conductors—Wire Used in the Construction of Ordnance, Torpedo Nets, and Flywheels, &c.—Chemical, Physical, and Mechanical Considerations <i>re</i> Metals Used in the Wire Industry—The Gauge Question, &c. 1 to 29	

SECTION I.

THE MANUFACTURE AND USES OF WIRE.

CHAPTER I.

IRON AND STEEL WIRE.

The Principle of Producing Rods and Wire Explained—Chemical and Physical Considerations in Iron and Steel—Puddled and Charcoal Iron Wire—Swedish Iron—Definitions of Steel—Distinction between Iron and Steel—Mild and High-Carbon Steels—Acid and Basic Bessemer, Siemens-Martin, and Crucible Steels—Properties of Elements present in Iron and Steel—Physical Characteristics of Iron and Steel—Wire Rod Billets, their Forms, Weights, and Chemical Compo-

www.libtool.com.cn

United States: International Trade Considerations—Railway and Shipping Rates of Carriage, &c.—Comments on British and Foreign Exports, &c.	125 to 134
---	------------

CHAPTER IV.

ELECTRICAL CONDUCTORS.

Mattheissen's Standard of Electrical Conductivity—Purity of Copper and its Influence on Conductivity—Fitzpatrick's Research—Soft and Hard-drawn Copper Wires—Comparative Conductivity of Copper and Iron Wire, and Effects of Temperature, Density, and Impurities on same—Durability of Electrical Conductors—Electrolytically deposited Copper—Weiller's Table of Conductors—Sizes, Weights, and Resistances of Silicious - Bronze and Hard-drawn Copper Wires—Effects of Temperatures upon Telegraph, &c., Lines, their "Sag" and Tension, &c.—Telegraph Wire Joints—Postal and Railway Specifications <i>re</i> Supply of Telegraph, &c., Conductors—Iron and Steel Wires and Effects of Galvanising same, &c.—Charcoal Iron and Siemens' Steel Telegraph Wires, their Tempers and Properties, &c.—Electro-Welding of Wire—Telegraph Wire Tests—Compound Telegraph Wires—Glover's Wire Gauge and Table of Sizes, Weights, and Resistances, &c.	135 to 152
---	------------

SECTION II.

WORKED WIRE AND ITS APPLICATIONS.

CHAPTER V.

THE MANUFACTURE AND USES OF WIRE ROPES.

Invention of Wire Ropes—Albert's Experiments in the Hartz Mines—Wilson's Claims—Newall's Invention and Inauguration of the Industry in Great Britain—Early Rope Manufactures—Newall's Career—Selvagee Ropes—Formed or Stranded Ropes—Modern Wire Rope Works, their Arrangement and Equipment, &c.—Recent Constructions of Roping, their Manufacture explained—Flat Wire Ropes—Lang's Construction of Roping—Laidler's Rope—Scott's Locked Wire Sheathing—Latch and Batchelor's Locked coiled Ropes—Proportions for Lays in Compound Strands or Ropes—Flat or Oval Stranded Ropes—Westgarth's Construction—Electric-Cable Winding Ropes—Seale's Type of Roping—Hodson's Spiral Rope Core—Aerial Standing Ropes—Flexible Crane and Hoisting Ropes—Sash and Clothes Lines, Picture Cords, Fencing and Signal Strands, and Lightning Conductors, &c.—Wire Strand and Rope-making Machinery—Compound Stranding and Roping Machines—Practices in the Manufacture of Wire Ropes—Proportions of Lays in Strands and Ropes—American Rope-making Appliances—Considerations in

	PAGE
the Wire Rope Trade—Biggart's Paper on Wire Ropes —Fatigue of Steel and Cutting Action of Wires in Cables —Internal and External Wear—Deakin on Wire Ropes —Lengths of Ropes Equivalent to their Working Loads—Sizes of Drums and Pulleys for Ropes to work over—Rope Records kept at Mines—Irregularities in Quality and Durability of Wire Ropes—Criticisms on Dif- ferent Constructions of Wire Roping—Reasonable Sizes, Weights, and Strengths of Wire Ropes—Value of Uniform Tensile Efficiencies of Wire used in Cables—Gauge of Wires to produce a given Size of Roping—Diameters of Component Wires to run over Pulleys of determined Sizes —Lengths of Splices and their Relation to Ultimate Strengths of Roping—Jointing of Wires in Strands— Multiple laid Ropes—Comments on the Rope Trade of the United States; Prices obtained, Discounts given, Trade Conventions and Guarantees—American Firms Manufac- turing Wire Ropes—General Competition in the Home and Foreign Rope Trade; Manufactures Guaranteed to give a Definite Service—Ropes in Japan and the Australian Colonies, &c.—Rope Trials on the Melbourne and other Cable Tramways—Bullivant's Table of Round Wire Ropes —Ropes and the Victorian Goldfields—Wire Rope- making in India, &c.—Inconsistent and Impractical Wire Rope Specifications—General Considerations and Com- ments upon the Industry at Home and Abroad, &c.	153 to 222

CHAPTER VI.

SOME APPLICATIONS OF WIRE ROPES.

Main and Tail-Rope and Endless Rope Haulage in Mines.—The Report of the North of England Institute of Mining Engineers upon Underground Haulage Systems—Stated Efficiency of the Endless Chain System and Comparative Performances of Ropes—Haulage Exhibits at the Newcastle Mining Exhibition—Costs of Working various Rope Traction Systems in Mines—Rope Haulage from under, over, and side of Wagons, with Comments as to Comparative Efficiency—Details in Haulage Systems, *e.g.*, Pulleys, Driving Drum, Clutches, Rope-Tension Gear and Clipping, &c., Appliances—Systems of Underground Rope Haulage at Bedlington, Eldon, Harton, Hetton, Hodbarrow, Moresby, Seaton-Deleval, Tredegar, and Whitburn, &c., Mines—Cost of Endless Rope Haulage at Clifton and Cadzow Collieries—Capacity of Mining Wagons Worked as "Singles" or "Sets"—Curves and Gradients Worked by Rope Traction in Mines—Sections and Weights of Rails and Typical Permanent Ways and Switches, &c.—Leading and Trailing Rope-Clip Cars or Bogies—Hyslop on Defects of Side Haulage Systems—Mining Rope Haulage Engines—Ramsey's Rope-Clutch Bogie and Gripping Appendages—Automatic Rope-Clipping Appliances—Mining Lubricating Devices—Rope

	PAGE
Sockets and Attachments—Considerations and Comments upon the Employment of Ropes in Mines—Vertical Winding and Effects of Reverse Bends in Roping—Aerial Ropeways for Transporting Minerals and other Products—Carrington's and Otto's Systems of Aerial Rope Haulage—Aerial Lines at Gibraltar, Hong Kong, and in the Transvaal, &c.—Details of Construction and Cost of Operation, &c.—Aerial Knot Grips for Surmounting Steep Gradients—Rope Haulage and Winding Systems used in the Diamond Mines of South Africa—Rope Traction for Propelling Street and other Railway Vehicles—Railway Appliances in the U.S.A. for Transporting Spools of Continuous Wire Roping—Railway Distances and Freights in the States—Performances of the Traction Cables upon the New York and Brooklyn Bridge—Rope Gear used in the Erection of the Forth and Sukkar Bridges—Cranes and Hoisting Appliances employing Ropes—Shipbuilding and Launching and Wire Ropes used in connection therewith—Steel Marine Hawsers for Towing, Mooring, Warping, or Anchoring Purposes, and Reels and Nippers employed with same—Comparative Sizes, Weights, Strengths, Durability, and Cost of Wire Roping as against those of Vegetable Fibres, <i>e.g.</i> , Hemp and Manilla—Wire Ropes used for Raising Sunken Vessels—Transmission of Power by Ropes, Speeds of Driving and Cost of System, &c.—The Hudson River Wire Rope Suspension Bridge at Peekskill, U.S.A., &c. 223 to 283	

CHAPTER VII.

WIRE NETTING AND WOVEN FABRICS, &c., THEIR
MANUFACTURE AND USES.

Invention of Wire Netting and Inauguration of its Mechanical Production—Barnard's Original Wire Netting Machine, and Modern Improvements in the Mechanical Manufacture—Meshes, Gauges, and Widths of Netting commonly adopted in the Industry—Characteristics of Wire Netting made for Home and Foreign Markets, with Weights of same per Mile, &c.—American Practice in the Trade—Modern Wire Netting Machinery, <i>e.g.</i> , as constructed by Wilmott Brothers and Bond, &c.—The Principle of the Mechanical Manufacture explained—Spring Winding or Coiling Machines—Mechanical Means for Tight-Rolling Wire Netting for Home and Export Markets—Dennis' continuous Wire Netting Machine, its Construction and Operation—Machinery employed in the Manufacture of Wire Webs or Woven Fabrics—Automatic Power Looms for Weaving Wire, &c.—Makers of Strong Wire Webs and Fine Gauzes—Wire Torpedo Nets as used by Home and Foreign Navies—Spiral Woven Wire Netting, &c.—Golding's Expanded or Meshed Metalwork as a Substitute for certain Wire Fabrications, &c. 284 to 311	
--	--

www.libtool.com. CHAPTER VIII.

WIRE FENCING MATERIALS AND APPENDAGES, WIRE STAPLES,
NAILS AND SUNDRIES.

Various Forms of Wire Fencing Materials and Dates of Introduction—Fencing Wire when First Used at Home and in the Colonies—Capital Invested in Fencing Properties in the United Kingdom, and Annual Cost of Maintaining same—Solid-Rolled, Drawn, Varnished, and Galvanised Fencing Wire, with Means of Erection and Attachments, &c.—Barbed Wire Fencing, the Invention, Licensed Makers, its Merits and Weaknesses, &c.—Ordinary Fencing Wire used in the Colonies, how Manufactured, Coiled and Varnished, &c.—German <i>versus</i> English Fencing Wire—Lengths of Wire sought in the Markets—Superiority of Galvanised Wire—Drawbacks in the Employment of Common Grades of Fencing Wire—Advantages of Superior Steel Wire over that of Iron or Soft Steel, with Comments and Comparisons respecting their different Physical and Mechanical Properties—Fencing Ribbons, Oval and Corrugated Wires, &c.—Various descriptions of Fencing Strands—Different Constructions of Barbed Fencing Wire and Appliances used for its Erection—Typical Illustrations of Strained Wire and Strand Fencing, with Pillars, Standards, and Wire, &c., used in same—“Porcupine” Tree Guards—Comparative Lengths and Weights of Solid Fencing Wires and Strands—“Droppers” used in Strained Wire Fences—Espalier Wires for Training Trees and Plants, &c.—Tools used in the Erection of various kinds of Wire Fencing—Hurdles and Fences of Expanded Metal—Horticultural Temples, Flower Stands, and other Wirework—Wire Nail Machines and Presses, &c.	312 to 335
Index...	339 to 347

LIST OF ILLUSTRATIONS.

	PAGE
Sections of Wire Rod Billets	39
Bedson's Wire Rod Rolling Mill	44
Bleckly's Rod Mill	45
Garrett's Continuous Rod Mill in the U.S.A.	48, 49
Wire-Drawing Mill or Blocks	53
Steel Wire Improving Apparatus	61
Bedson's Annealing and Galvanising Plant	64
Modern Wire-Galvanising Appliances	65
The Standard Wire Gauge (Template)	73
Continental Wire-Testing Machinery	77
Carringtons' Tensional and Torsional Wire-Testing Ma- chinery	80, 81
Denison's Wire-Testing Machinery	82
Kitchin's Wire-Testing Machinery	85, 87
Byrne's Continuous Wire-Drawing Mill	90
Wire-Straightening Machines	92
Plan of Ryland's Works	94
Bolton's Continuous Wire Mill	103, 105
The Micrometer for Gauging Wire	116
Felten & Guilleaume's Works, Cologne	119
"Britannia" Telegraph Wire Joint	142
Telegraph Wire-Testing Appliances	146
Glover's Wire Gauge or Micrometer	150
Twenty-four Bobbin Wire-Stranding Machines	163
Large Horizontal Wire Rope-Closing Machines	165
Hydraulic Rope-Testing Machinery	169
Lang's Construction of Wire Rope	173
Laidler's Rope	175
Scott's Locked Wire Sheathing	176
Latch and Batchelor's Locked Coil Ropes	177
Diagram of Proportions of Lays in Roping	178
Flattened or Oval Stranded Ropes	180
Westgarth's Rope	182
Seale's Construction of Cable	184
Hodson's Spiral Wire Rope Core	185
Aerial Ropes for Tramways	185
Vertical Rope-Closing Machines	193
Twelve Bobbin Stranding Machinery	195
Compound Tandem Stranding Machines	198
Compound Stranding and Roping Machinery	(folding plate) { 198
Stone's Rope Making Machinery of U.S.A.	205
Plan of Mining Haulage Systems	228
Details in Mining Rope-Haulage Systems	230
Driving Pulleys for Wire Roping	232
Systems of Rope Haulage under Wagons	234
Rope Clips or Grips used in Rope Traction	236, 238
Haulage over Top and Side of Wagons	238

	PAGE
Pulleys and Gates for Side Haulage Systems	240
Ramsey's Rope Clutch Cr.	242
Rope Haulage Engines	244
Automatic Rope Haulage Clips	247, 249
Mining Lubricating Appliances	249
Socket Attachments for Wire Ropes	250
Vertical Shaft Working in Mines	252
Aerial Ropeway at Hong Kong	256
Aerial Rope Transports at Gibraltar	257, 258
Otto's System of Aerial Ropeways	260
Details of Construction in Aerial Lines	262
Aerial Rope-Gripping Appliances	263, 264
Driving Knots on Aerial Ropes	265
Section of Sheba Aerial Line	266
Railway Wagon for Transporting Roping	270
Erection Ropes of the Forth Bridge	275
Ropes Used in the Construction of the Sukkar Bridge	276
Cranes and Rope-Hoisting Appliances	277
Reels and Nippers for Marine Wire Hawsers	279
Raising of Sunken Vessels by Wire Ropes	281
Wilmott's Wire Netting Machinery	287
Diagrams Explaining the Manufacture of Netting	289, 290
Bond's Compact Adjustable Netting Machine	292
Spring Winding Machines	292
Dennis' Continuous Wire Netting Machine	297
Wire Weaving Looms	302
Netting for Protecting Vessels against Torpedoes	305
Spiral Wire Woven Matting	305
Machinery Employed for Making "Expanded Metal"	308, 309
Samples of Mesh-Expanded Metal	310
Coils or Hanks of Common Fencing Wire	313
Wire Staples for Fencing, &c., Purposes	314
Barbed Wire and Fencing	316
Cattle Enclosures Formed of Barbed Wire	317
Apparatus Used in the Erection of Barbed Fencing	318
Appliances for Jointing Barbed Strands	319
Fencing Structures Employing Barbed Wire	320
Barbed or "Porcupine" Tree Guards	321
Strained Wire Park Fences, &c.	321
Strained Wire and Strand Fencing for Cattle, &c.	323
Angle Strainers and Winders Used in Fencing	324
Fencing Standards and Tightening Appliances	326
"Droppers" Used in Wire Fences	327
Espalier or Tree-Training Fences	327
Tools Used in the Erection of Wire Fencing	328
Fencing of Expanded or Meshed Metal	329
Horticultural Wirework	332, 333
Wire Nail Machinery and Presses, &c.	334

LIST OF TABLES.

	PAGE
Chemical Analyses of Steel Wire Rod Billets	39 to 41
Mechanical Properties of Iron and Steel Wire	42
Chemical Composition and Properties of Plough Steel Wire	58
Tabulation of Rope Wire Tests	68
Chemical Composition and Properties, &c., of Piano Wire	69 to 71
Sizes, Weights, Lengths, and Strengths of Iron Wire	72
Sizes, &c., and Breaking Strengths of Steel Wire	74
Tensile Strengths of Wire in Pounds for 1 Ton per each $\frac{1}{1000}$ in.	76
Table for Calculating Strengths of Wire from No. 20. to No. 40 S. W. G.	116
Wire Gauges Used till 1883 (Obsolete)	126
Imperial Standard Wire Gauge	128
English Standard and German Millimetre Gauges	129
American National Wire Gauge	130
Fitzpatrick's Research <i>re</i> Mattheissen's Electrical Standards	137
Weiller's Table of Electrical Conductors	137
Sizes, Weights, and Electrical Resistances of Silicium-Bronze Wire	139
Silicious-Bronze Wires Shown at the French Exhibition	140
Sizes, Weights, Strengths, and Conductivity of Hard-Drawn Copper Wire	141
Tension and Sag of Hard-Drawn Copper Telegraph Wire	142
Tables to Specifications for Copper Wire and Strands	143
Tables to Specifications for Galvanised Iron Telegraph Wire	147
Tables to Specifications for Postal and Railway Telegraph Wire	147 to 149
Glover's Wire Gauge for Electrical Wires, and Table of Sizes, Lengths, Weights, and Resistances of Copper Wire	150
Proportions of Lays in Strands and Roping	174
Biggart <i>re</i> Forth Bridge Ropes	210
Deakin <i>re</i> Weights and Working Loads of Ropes	213
Reasonable Weights and Strengths of Ropes	214
Particulars of Flexible Crane Ropes	217
Table of Sizes, Weights, and Strengths of Wire Roping	221
Comparative Costs of Rope Haulage Systems	225
Aerial Ropeways in the Transvaal	266
Meshes and Gauges of Wire Netting	285
Comparative Lengths and Weights of Fencing Wire and Strands	322

www.libtool.com.cn

INTRODUCTORY.



THE manufacture of those metallic filaments or shreds, known as *wire*, is one of considerable antiquity, and has been traced by good authorities as far back as the period of early Egypt. Gold wire is mentioned in connection with the decorations of the Sacerdotal robes of Aaron, whilst metallic shreds—it is recorded—have been actually discovered that date as distant as 1700 B.C. A specimen of wire made by the Ninevites some 800 years B.C. is exhibited at the Kensington Museum. Homer and Pliny referred to similar productions in their early writings. Metal heads, with imitation hair of wire, recovered from the ruins of Herculaneum are in the Portici Museum. From such remote eras up to the fourteenth century, wire in its general acceptation was produced by hammering out strips of metal, and not by the process of “drawing” as practised at the present time. In the middle ages this industry was extensively pursued, and the artificers thus engaged were termed, in the trade, “wire-smiths,” but in the earliest days of the manufacture, gold, silver, and bronze appear to have been the only metals so treated. It is, however, fairly substantiated by technical records that the present method of “drawing wire” was practised in the Lenne district of Germany during the fourteenth century, for we find in the histories of Augsburg and Nurem-

berg, dated 1351 and 1360 respectively, the term "drahtzieher" (wiredrawer), mentioned in connection with this industry, so that it is reasonable to infer that the "drawplate" was known and used at this period: possibly the first wire-drawing mill was that erected at Nuremberg by a man named Rudolf shortly after the time above mentioned, or when the art of hand-drawing wire had reached some degree of excellence. At least, so the writings of Conrad Celtes, of 1490, lead us to understand.

About the year 1500 the credit of "wiredrawing" was ascribed in France to one Richard Archal, and even now some classes of wire produced in this country are known as "fil d'Archal." According to Beckmann's "History of Inventions," published in London, 1817, as little was definitely known about the claims of Archal as those attributed to Rudolf of Nuremberg.

It was not, however, until about 1565 that machine-drawn wire was produced in Great Britain, and when, it is recorded, a Saxon, C. Schultz, and Caleb Bell, came over to this country, in concert with other foreigners, with the view of establishing the industry here, and for which the permission of Queen Elizabeth had been obtained. Bell had charge of a mill in Greenfield Valley, Holywell, driven by water power, and from this the Queen was supplied with toilette pins. Relics of the mill may still be seen. The spring from which Bell derived his source of power is known as "Gallopell," evidently a corruption of the utiliser's name. Inferior hand-drawn wire had been, and was being, manufactured in the neighbourhood of the Forest of Dean and elsewhere, but, in the seventeenth century, the improved fabrication was carried on in Yorkshire, and later, in the districts of Warrington and Birmingham, or where the industry is still largely located.

In the year 1630 a proclamation was issued by Charles I., to the effect that the home industry had made

such advancements that further foreign imports of wire were forthwith prohibited. This was the second trial of home trade protection, for in 1465 we learn that the importation of iron wire into this country was forbidden, although, however, soon afterwards this law was cancelled owing to the inferior productions of our own manufacturers. Wire at this date was largely made of "Osmond" iron, *i.e.*, selected ore treated with charcoal fuel, and probably an imitation of Swedish iron. In 1663 the first mechanical wire mill proper was erected in England, at Sheen, near Richmond, and from this date the industry maintained a substantial footing, and established a series of progressive developments. It should not, however, be imagined that the Germans, who were the pioneers in the industry of wiredrawing, allowed themselves to be quietly superseded; on the contrary, they kept plodding on, and are still to-day our most formidable competitors in the trade.

From the year 1800 the Warrington district has been continually identified with the production of wire and the various developments of the industry, and it was at this date that one Captain Ainsworth projected works in this neighbourhood in concert with a practical wiredrawer named Nathaniel Greening. The proposed arrangements, however, fell through, and we next hear of the latter gentleman joining Mr. John Rylands to carry out the contemplated scheme or original programme. Preliminaries having been satisfactorily arranged and the works equipped, these gentlemen commenced to manufacture in 1805, and continued to work together until about 1840, when the partnership was dissolved, and Rylands' three sons, John, Glazebrook, and Peter, succeeded their father in the business, under the title of Messrs. Rylands Brothers. At the same time Mr. Greening brought his sons into the trade and started a separate establishment, styled Messrs. Greening & Sons, the father

4 *Early Manufactures in Lancashire and Yorkshire, &c.*

continuing in the business until 1851. This firm was carried on under the same title for some three years later, or, until Mr. T. Greening retired to commence business on his own account ; he afterwards proceeded to Canada and founded a similar enterprise there. The firm of Messrs. N. Greening & Sons, Limited, are still carrying on business in Warrington. In 1868 Messrs. Rylands Brothers turned their concern into a limited company, which has since enjoyed a prosperous career, and is to-day one of the finest factories in the trade ; indeed, so much do the above gentlemen's names occur in connection with the history and development of the wire industry in this country that further reference will be made to their latest doings in subsequent chapters of this treatise.

The Whitecross Wire Mill, Warrington, was founded by Mr. T. Monks, from Messrs. Rylands, whilst the Longford Mill, in the same locality, was inaugurated by Messrs. G. and E. Woods, sons of a fine wire drawer in the same firm's employ.

G. Bedson, the originator of continuous wire rod rolling and galvanising, was also engaged with Messrs. Rylands in his early days, and afterwards went into Messrs. Johnson and Nephews' employ, who commenced business about the same time as the original Mr. Rylands.

Turning our attention to persons in other districts who were associated with the origin of the industry in this country, none are more important than those now incorporated firms of Messrs. Webster, Horsfall & Lean, of Birmingham, and Messrs. Royston & Sons, of Halifax. Indeed, the founder of the former firm, Mr. Webster, commenced business in 1720, and his name, in conjunction with that of Mr. Horsfall, is inseparable from the introduction of superior grades of steel wire which attracted great attention in the Exhibition of 1851. The firm of Messrs. Royston & Sons was founded in 1797, and is probably

about the oldest manufacturers of card wire in this country. libtool.com.cn

In Germany, as early as 1750, Mr. Felten, of the since eminent firm of Felten and Guilleaume, laid the foundation of their present extensive factories near Cologne. In America, perhaps no firm is more deservedly well known than that of Messrs. Roebling & Sons, of Trenton, who commenced business in 1849. Messrs. Washburn and Moen, however, commenced wire-drawing in the States some eighteen years previously, whilst the Trenton Iron Company must also be reckoned amongst the earliest founders of the wire industry in the States.

At the present time Belgium furnishes a considerable quantity of wire products to export markets. Outside the United States, the world's supply of plain and worked wire of various kinds is practically derived from Great Britain, Germany, and Belgium, and not even Australia, with all her consumption, has as yet deemed it desirable to establish wire mills of her own.

The uses of various kinds of wire are practically innumerable, although probably the following list comprises the most important applications: *e.g.*, for electric conductors, and philosophical and other scientific instruments; for willowing and carding machines for textile purposes; for the dressing of flour and other granular substances; in the construction of malt and other drying kilns; for the manufacture of ropes employed for marine, mining, agricultural, engineering, and other purposes; for the fabrication of sieves, riddles, screens, gauze, cloth, netting, blinds, fenders, guards, brushes, bale ties, mattresses, upholstery and other springs, culinary utensils, covers, cages, baskets, mats, bottle bins, picture, window, and clothes lines, &c., cycles, spectacle frames, watch springs, tinworkers' articles, pins, needles, nails, rivets, fish hooks, umbrella ribs, corkscrews, drills, pinions, hooks and eyes, buckles, spangles, filigree work,

and lace, &c.; for musical instruments; for gates, railings, hurdles, fencing, and trellis work, aviaries, &c.

The foregoing synopsis of uses alone involves very numerous descriptions of wire manufactured from various metals, *e.g.*, silver, platinum, copper, bronze, brass, iron, and steel, and in sizes ranging from $\frac{1}{4}$ th to $\frac{1}{7000}$ th of an inch, and possessing tensile resistances of from about 20 to 150 tons per square inch of sectional area. It will, therefore, be readily understood that if the above list of industries dependent upon wire were described in detail, the limits of this work would be extended indefinitely. However, from what has been already written the reader cannot fail to recognize how intimately the manufacture and uses of wire are associated with the every day necessities of life. Take the single application of wire for land and marine telegraphs, in principle first applied upon the old Blackwall railway of 1840, and with which the name of Cook is indelibly connected, followed by those, none less significant, Morse and Wheatstone, &c. To these gentlemen we are mainly indebted for the inauguration of a system for working and controlling railway traffic with safety and despatch, and which would have been impossible to achieve without the aid of electrical signalling and telegraphic appliances now in use. The value and importance of such inventions will be more apparent when we reflect that to-day we have 19,900 miles of railway within our Kingdom alone, that cost over 876 million pounds to construct and equip, and upon which 775 million passengers were carried during the last year. Of more recent date, the establishment of telephonic and electric lighting installations, has opened up a large field for the employment of copper and bronze wire, &c. Of late years the construction of dynamo machines for generating electricity for illuminating and electro-plating, &c., purposes, has founded an industry of importance and considerable value to the wire trade.

The amount of insulated copper wire wound upon the armatures and field-magnets of such machines may range from about 5 to 150 miles in length. Messrs. Crompton and Co. have constructed dynamo-electric machines with three tons of wire on the magnets, and which, when wound for an electro-motive force of 400 volts, would constitute 100 miles of No. 16 gauge wire.

Some readers may perhaps remember App's great Inductorium constructed in 1868 for the Polytechnic Institution. This colossal piece of apparatus contained an enormous quantity of copper wire, and gave some very brilliant results. However, in 1876, the same inventor and manufacturer constructed another induction coil of still greater power for Mr. Spottiswoode, F.R.S. This contained two primary helices of insulated copper wire 660 yards and 504 yards in length, whilst the secondary coil was composed of 280 miles of similar wire, tightly wound into cylindrical form (20 in. in diam. and 37 in. long), the electrical conductivity of which was 93 per cent., and the resistance 110,200 ohms. With a Grove battery of thirty 5-quart cells, a spark 42 in. in length was obtained, capable of penetrating a block of flint glass 6 in. thick.

According to official returns there are 183,467 miles of telegraph wire employed in the overland service of this kingdom. The Western Union Telegraph Co., of U.S.A., has 648,000 miles of wire in their system alone. Over 57 million messages were transmitted during last year by our inland telegraph services, and from which a revenue of upwards of two millions sterling accrued, besides finding employment for 108,500 hands.

The first submarine telegraph cable was laid in 1850 from Dover to Calais, a distance of twenty-five miles, and so invaluable were its demonstrations of utility, that after the construction of numerous others of increasing importance, a cable was laid between Ireland and America in 1858, a distance of over 2,000 miles; it was through this cable that our Queen sent the first telegraphic message to President

Buchanan. At the close of last year the Telegraph Construction and Maintenance Co., of London, had laid 97,000 nautical miles of submarine cables, and which represents something like 80 per cent. of the total mileage laid throughout the world.

The scope of this volume will not permit of any lengthy description of telegraph cables, although considerable attention will hereafter be devoted to the kindred art of wire ropemaking, an industry which originated with the Germans in 1834.

Since the practical inauguration of electric traction for street railways, over 1500 miles of overhead copper conductors have been erected in some of the principal cities of the United States within the last three years.

Those readers who have had an opportunity of seeing the stupendous and elegant suspension bridges across the Niagara River, and that from New York to Brooklyn, are familiar with beautiful and colossal examples of the uses of wire for structural purposes. The last great achievement of engineering skill with which the name of Roebling will always remain inseparable, presents a clear or main river span of 1600 ft., at an elevation of 135 ft. above high water mark, the huge suspension cables being composed of 6400 separate wires. Again, the railway across this structure is a typical illustration, amongst many in the United States, of the use of wire ropes for traction purposes.

Every hour of the day wire ropes are rendering some important service from which the community at large are enjoying most substantial benefits, whether in connection with our enormous shipping interests, the tilling of land, or the working of mines, &c. Last year 170,000,000 tons of coal were raised in Great Britain alone mainly by the agency of wire ropes.

Again, the manufacture and uses of wire netting, gauze, and cloth, are amongst the many ingenious and serviceable applications of wire, the last-mentioned affording almost as

contradictory a production, and as difficult at first to appreciate, as the manufacture of mineral fabrics, but they are none the less practical achievements now extensively used. There is the common type of wire netting, of which many million yards are annually produced and sold for agricultural and stock purposes, and notably that in our Australian and New Zealand markets for repelling their devastating invasion of rabbits. Mr. Barnard, of Norwich, in 1865, invented the first machine for making this class of netting. On the other hand there are fine woven wire gauzes and cloths, some of which are made with as many as 40,000 meshes to the square inch.

Many thousand tons of plain fencing wire, strands and barbed wire are annually manufactured and sold in all parts of the globe for guarding highways, railways, estates, farms, cattle ranches, stock stations, &c.

Again, carding wire is a product of no less magnitude and importance, and when we only pause to reflect upon the enormous annual production and sale of woollen fabrics, we shall to some degree, appreciate the services of another branch of the industry we are considering. The Woollen Export trade of Great Britain alone is worth about £27,000,000 per annum.

The more delicate classes of wire find applications in philosophical and other scientific instruments, such as astronomical telescopes, theodolites, levels, &c. Beautiful types of wires are to be found in the eye pieces of such appliances, in the form of hair or spider lines for assisting in the observation of moving stars, planets, or bodies, and their relative bearings, for measuring angles or determining elevations and gradients, &c. So exquisitely fine are the wires thus employed that the hairs of our heads, or the silk threads of the worm, form but insignificant comparisons. The former has been estimated to average about $\frac{1}{8000}$ th, and the latter $\frac{1}{8000}$ th part of an inch in diameter, whereas platinum wire has been drawn to $\frac{1}{8000}$ th of an inch and

even to $\frac{1}{25000}$ th of an inch, but the last example is more a scientific curiosity than a production of much practical utility.

It is recorded in annals of physical science, that one Wollaston obtained a platinum wire as fine as 0.00003 in. in diameter, and that 1060 yards only weighed 0.75 grain, which is at the rate of 1.25 grains per mile. This result was, however, obtained by covering the wire with a silver coating, which, after being drawn down with the platinum to as fine a degree as possible, was dissolved off by a solution of nitric acid.

Platinum and other wires are also used in galvanic cauteries, ecraseurs, magnetic machines, probes and other surgical instruments or appliances.

Somewhat recently Sir William Thomson has employed steel wire of high breaking strains in connection with his ingenious and now extensively used deep-sea sounding apparatus.

Pins are regarded by most as emblems of insignificance, but their manufacture nevertheless now forms an important branch of British industry, and it has been estimated by competent authorities that their production in this country alone amounts to 50,000,000 daily, and three-fourths of this quantity are made in Birmingham. In Henry VIII's time pins must have been rather clumsy articles, and were controlled by a legislated specification as follows: "No person shall put to sale any pins as shall not be double-headed and soldered fast to the shank, well smoothed, shaven, filed, canted and sharpened, &c." In Charles I.'s reign the industry had made evident progress, for a Pinmakers' Corporation was then founded in London.

Adam Smith, a century ago, gave us a very interesting description of the manufacture of pins as then carried out. At this time an uneducated workman could scarcely make a dozen pins in a day, but within the last fifty years the trade has been quite revolutionised by the introduction of

machinery. Shortly after 1824 an American, L. W. Wright, invented a machine by which a perfect pin was produced during the revolution of a single wheel. The machine was first practically worked in a factory at Lambeth, but soon afterwards it was removed to Stroud in Gloucestershire—the seat of the pin industry—and operated under the auspices of Messrs. D. F. Taylor & Co., who later removed to Birmingham and established their present extensive works in George-street, Parade. This firm now manufactures its own wire employed in making pins and kindred products.

With few exceptions pins are made of brass wire. The alloy is first cast into ingots and then rolled down into bars of suitable sizes, which are afterwards cut into strips by machinery devised for the purpose. These pieces, of square section, are next converted into cylindrical wire by the ordinary process of drawing. The amount of wire used annually in this industry is something enormous, and as will be understood by the fact that the Birmingham consumption alone represents a value of about £100,000 per annum for merely raw material employed in the manufacture. Messrs Taylor & Co. were the original introducers of solid-headed pins now universally used. Pin-making machines operated in this firm's factory are monuments of ingenuity and skill, each measuring only 28 in. long, 19 in. wide, and 17 in. high. The wire is straightened as it is drawn from the feeding reels into a machine, where it is seized by dies, whilst an automatic punch forms the head of the pin. The piece is then cut off to the required length which passes on into a slotted tray, where it is suspended by the head whilst a revolving disc beneath points its opposite end. These mechanical operations are carried on at a speed difficult for the eye to follow. Pins thus formed are next cleaned and "whitened" by treatment in a vessel containing a hot solution of bi-tartrate of potash and tin;

after this process they are dried and polished by bran or sawdust kept in agitation within a revolving barrel. The pins are then placed into a hopper leading to a longitudinally slotted plate, which, with the aid of a special tool, works them in rows upon crimped papers, termed in the trade "sticking or papering," an operation carried out with amazing rapidity and accuracy.

The wholesale prices of ordinary pins may range from 1s. 3d. to 3s. per pound, and on an average some 16,000 go to make this weight; entomological pins cost about 7s. per pound, and 4000 or more of this class only weigh 1 oz.

Messrs. Taylor & Co., as already mentioned, have been identified with the industry from its infancy and now hold the distinction of being pinmakers by special appointment to Her Majesty the Queen, besides having invariably secured medals or awards at various leading exhibitions. Each machine now used in this firm's establishment produces 200 finished pins per minute, which is indeed a striking contrast to the wearisome manufacture of Adam Smith's days.

Needles are manufactured out of superior qualities of cast steel wire cut into lengths to make two at a time. These pieces are straightened upon an iron table by means of an instrument termed a "rubbing knife." The wire is then pointed by automatic machinery provided with a fan and shaft to carry away the steel and grindstone dust, which is very injurious to inhale. In former days the lives of workmen employed in the needle trade were considerably shortened by breathing air charged with such particles. Indeed, the following is a narrative told by a doctor in the district of the industry concerning a patient, a hand needle-pointer by trade, who complained that he felt a hard ball of something in his trachea, which rose and fell between his chest and throat. The doctor ridiculed the idea and told him it was nonsense, but the man still

persisted it was there, and asked him if he died to examine him. After the poor fellow's death a post mortem examination was made and resulted in a solid mass of steel and stone dust about the size of a bird's egg being found, as he had said, in his throat, and the lungs were so encrusted with steel that a knife would scarcely pierce them. It was therefore truly a blessing to these busy workers when this deadly process was done away with, and in its stead a healthy and still remunerative one substituted.

After the operation of pointing, the wires are stamped and then pierced to form the eyes. As the diameters of the wires used in this industry are usually very small, *e. g.* .03 of an inch, it will be readily apparent that the above process involves considerable accuracy and skill. The "burrs" produced by stamping are afterwards removed by means of flat grindstones called filing machines. A "spit" of these double needles is next placed between a hand vice, termed "clams," and divided into single ones, requiring only to have their heads "rounded" by filing to furnish the complete articles.

A finished needle, however, must have a hard and elastic temper, whereas these, in their present state, are softer than the wire out of which they were made. Therefore, after the needles have been burnished in the eyes, they are hardened by heating in an oven, and subsequently cooled by plunging them into oil. This rapid cooling of the steel makes it as brittle as glass. The needles will now almost break upon touching them, indeed, in this condition they would be as useless as in the soft state. To reduce them to a perfect state of elasticity their temperature has to be again raised to about 600 degrees, and then by allowing them to cool gradually the required degree of elasticity is obtained. During the process of hardening the fire makes many of the needles crooked, and these have to be picked out and straightened by a small hammer, one

at a time on an anvil. The heads are afterwards softened by the application of heat for facilitating burnishing. The process of scouring the needles bright takes about a week. They are mixed with oil, soft soap and emery powder, wrapped in loose canvas, and placed in a kind of mangle worked by mechanical power. This scouring process done, the needles are washed in hot water and dried in sawdust.

The points, slightly blunted by passing through the various processes described, are now set upon a small revolving grindstone and the eyes reburnished. The next operation is that of polishing the needles, and which is performed by a rapidly rotating wheel covered with prepared leather. The needles are caused to pass many times over the leather in order to thoroughly polish them. Finally, they are counted and stuck by women into cloth, wrapped in paper, and labelled for the market.

Typical examples of the manufacture of ordinary and sewing machine needles, fish hooks and crochet hooks, &c., from wire, may be seen on an extensive scale at Messrs. Bartleet & Son's mills at Redditch. This firm was established in 1750, and since has achieved eleven Gold Medals at various leading exhibitions for excellence of manufacture.

The wholesale value of ordinary needles varies from 1s. to 5s. per 1000 according to quality, and taking an average size, say No. 6, equivalent to $\frac{2}{1000}$ th of an inch in diameter, 3500 will go to the pound.

Fish hooks are made from similar wire to that used for the production of needles and are very anolagously treated, the "beards or barbs" being filed in and the shanks flattened and ringed amongst the final processes. Some 4000 small hooks may go to the ounce, and their value would be about £5 10s. per lb.

Cast-steel wire of special sections is also extensively used in the manufacture of umbrella frames. Samuel Fox

in 1852, was the first to advocate the employment of metallic ribs for the construction of these articles. Umbrellas are probably of Asiatic origin, and were ultimately introduced into this country from Italy in about 1712. Jonas Hanway, who died in 1786, was the first person in this country to habitually carry an umbrella.

The King of Burmah, in addressing the Governor-General of India in 1885, styled himself "the Monarch who reigns over the umbrella-wearing Chiefs of Eastern Countries." Prior, however, to Mr. Fox's invention, umbrella frames were composed of whalebone, cane, and other similar materials. Now, at Messrs. Fox & Co.'s works at Stocksbridge, near Sheffield, an enormous quantity of umbrella frames are annually produced from the best cast steel wire, in sizes ranging from 6 in. to 12 ft. in diameter. The average weight of one of this firm's frames is about 5½ to 6 oz. Messrs. Fox & Co. manufacture the steel and wire required by them for the production of their well-known specialities. Mr. Fox was also amongst the first manufacturers of special qualities of steel for the production of card wire. Messrs. Beesley & Co., of Sheffield, also furnish large quantities of umbrella wire of Bessemer and Siemen-Martin steel. Immense quantities of this class of wire are further annually produced in France, Germany, and the United States. The Japanese, even, now produce their own umbrella wire. These ribs are usually of two kinds, viz., solid and channel shaped, and the wire has to be especially hardened and tempered for the purpose.

Solid hard-drawn steel wire finds a very serviceable application in the manufacture of spectacle frames. The lens or eyepieces are grooved to permit of the wire being suitably bent around them for carrying the same. Spectacle making is still almost entirely carried out by hand, as so much care has to be exercised in accommodating the variable requirements of different wearers. The in-

vention of spectacles is ascribed by some authorities to Roger Bacon during the Thirteenth Century, whilst others attribute their origin to foreign contemporaries. At present, the average weight of an ordinary spectacle frame is about $2\frac{1}{2}$ dwts. The springs are commonly forged out of steel wire, subsequently smoothed up by means of files and emery wheels. The frames are then hardened, tempered, and coloured through the medium of cold oil and heated sand.

The watch spring industry affords an interesting exemplification of the use of steel wire in a finely divided or worked form. Professor Babbage many years ago directed attention to the fact that hair springs had been manufactured of only $\frac{1}{10}$ of a grain in weight, and that some 50,000 of such delicate articles were produced from 1 lb. of iron originally valued at about twopence. Such very fine sizes are, however, more for exhibition purposes than practical use. Watch springs weighing from $\frac{1}{2}$ a gr. to $\frac{1}{2}$ a dwt. each are about the range of sizes commonly employed in the trade. It is now generally recognised that no more forcible example of the value of labour as against the raw material, can be cited than that demonstrated by the manufacture of watch springs. Thompson remarks in his treatise on "Timekeepers," "the chisel of the sculptor may add immense value to a block of marble and the cameo may become of great price from labour bestowed upon it. But art offers no example wherein the cost of the material is so greatly enhanced by human skill as in the hair spring of a watch." At the International Exhibition of 1863, Messrs. Ganeval & Co., of London, were awarded a Gold Medal for a hair spring, demonstrating how by manual labour alone an instrument was produced of 160,000 times the value of the raw material employed in the manufacture. It should be understood that watches contain two distinct springs, *i.e.*, main and hair or balance springs, and it is the latter

kind which are made out of steel wire in such finely divided forms, *e.g.*, 2 to 5 doz. to the dwt. The hair spring of a watch is in the form of a flat spiral and determines the time of the vibrations of the balance wheel, which in the case of an ordinary watch train and escapement is about four or five impulses per second. This class of balance spring was shown in London in 1675, or when the invention was claimed by Huygens and other contemporaries.

Prior to this time some old Continental watches contained pigs' bristles for causing the oscillation of the balance wheels. P. le Roy is credited with having invented the isochronal balance spring in 1766, and upon which the regularity of timekeepers is still largely dependent.

Superior crucible steel wire is required for the manufacture of these springs, a speciality for which Houghton, of Warrington, has achieved a high reputation amongst the makers of this country. Having obtained a high quality of homogeneous cast steel of uniform elasticity, the subsequent processes of annealing, hardening, and tempering perform very important functions. The wire is drawn down through polished holes in stones or gems, until it is reduced to about the size of a human hair, with a highly smooth surface. The length of wire manipulated may range from 50 to 1500 yards, and the final polishing is effected by the employment of very fine emery powder. Having obtained a wire, say 1000 yards in length and $\frac{1}{500}$ th of an inch in diameter, absolutely free from rust or blemish, it is flattened out to a required width and thickness, and then cut up into suitable lengths. Spiral springs are formed out of these pieces by heating two or three coiled lengths at a time, which are afterwards cooled, polished, and coloured. The requisite hardness is obtained by quenching the hot wire in a cold oil bath, and the tempering is effected by "blazing off" the film of oil retained at a definite and uniform temperature. The elasticity of the

wire is enhanced by hammering upon a bright polished anvil. The process of "blueing" or colouring the springs, consists in heating them in a "muffle" over a spirit lamp to the required temperature to give the tint desired.

The value of balance springs may range from a few shillings a gross to 15s. each, according to quality and requirements; the latter price would be that paid for a hair spring for a superior class of adjusted watch. A large quantity of inferior and cheap watch springs are annually imported into this country from Europe, and the total approximate combined production during such period is estimated to be several millions. One of the few English watch spring makers remaining recently informed the writer that now many hundreds of gross of springs are yearly imported and sold here for less than one-fourth the price he could afford to produce a good article for. Main springs of English make may be purchased from about 6s. per dozen, whilst foreign ones may be bought in London from 18s. per gross.

The well-known English firm Messrs. Ganeval & Callard, Limited, has kindly supplied the writer with samples of wire balance springs weighing from $\frac{1}{10}$ gr. to 4 grs. each. The wire composing the former is as fine as any human hair, and twenty complete turns are made to form the flat spiral spring only measuring $\frac{3}{16}$ in. in diameter. This and the fine wire-drawing industry of precious metals certainly contribute the most delicate and beautiful examples in the various branches of the craft we are considering.

A large quantity of best cast-steel wire is also annually consumed for the manufacture of pinions and spindles for clocks and watches, a speciality with which the name of Houghton is prominently associated.

Hard drawn steel wire now finds an important field of employment in the spokes of velocipede or cycle wheels,

and some modern types of this class of machines admirably convey the great utility of wire for structural purposes, in which strength and lightness are inseparable requirements.

The manufacture of wire nails is an extensive industry, now mainly carried on by Continental firms, and when we appreciate that one modern machine will produce over 300 finished nails per minute, we may form some idea of the magnitude of these wire products. Some of the European factories turn out over a quarter of a million tons per annum. In 1617 Sir D. Bulmer invented a machine for cutting nail rods, and in 1790 T. Clifford made a recognised type of machine for forming nails out of such class of rods. Before nails were manufactured by machinery some 50,000 men were employed in the district of Birmingham for forging such products by hand.

Gut and wire were used by the early Egyptians, Greeks and Romans in the construction of musical instruments. The strings of the original dulcimers and clavicords are recorded as being composed of brass wires, and, indeed, were the class chiefly used until the manufacture of drawn iron wire in about 1350; some pianoforte makers retained brass strings up till 1830. Iron music wire was not much used until about 1511. Gut and wire have always held divided rule in music, and as exemplified to-day in the violin and piano. Notes, resulting from the vibrations of strings, are dependent upon their length, tension, and specific gravity, therefore it is evident that the materials of which they are composed perform important functions.

Early in the present century Nuremberg music wire was in great request, but in about 1820 that manufactured in Berlin attained preference. About 1840, Webster, of Birmingham, brought out his improved steel music wire, which exceeded the tensile standards of the German wire, but in 1850, Miller, of Vienna, achieved precedence. Since this date German music wire has again taken the lead,

According to experiments cited in Sir George Grove's Dictionary of Music, the tensile values of steel wire, of $17\frac{1}{2}$ gauge, supplied by Pohlmann (of Nuremberg), Miller and Webster are given as 297 lb., 275 lb., and 257 lb. respectively. However, as the decimal sizes of the wires are not stated, nor their equivalent tensile efficiencies in tons or pounds per square inch of sectional area given, the above results constitute incomplete comparisons. At this date (viz., 1882) the statement "Piano" or "Birmingham," or any other gauge, conveyed no accurate or reliable standard of measurement, and, as will be fully explained later on in this treatise, when we come to examine the gauge question generally.

Some idea of the present important scope for steel music wire may be gathered from the enormous number of pianofortes which are annually produced and sold. Messrs. Steinway & Sons, of New York, U.S.A., and London, alone claim to manufacture some 20,000 pianos per annum. The production of Germany, for a similar period, is given by authorities at 70,000, whilst London and Paris are able to contribute a yearly output of over 30,000 and 20,000 instruments respectively.

Amongst modern pianoforte makers, no firm so rapidly acquired a well-earned reputation as Steinway & Sons.

H. E. Steinway, the founder of the firm, was born in Brunswick in 1797. He served his time as a cabinet maker, but in 1839 he was a recognised piano manufacturer in his own country, and where his business flourished until the revolution of 1848. Subsequently, he left for the United States, with his sons, and in 1853 they founded the present well-known firm.

Amongst our manufacturers the names of Messrs. J. Broadwood & Sons will be familiar to most, whether in connection with their early origin or their high European reputation. This firm was established in 1732, and has

since passed through five generations of uninterrupted prosperity; they still occupy the identical house in Great Pulteney Street, W., in which their business was founded in the reign of George II. Messrs. John Broadwood & Sons have supplied the Court with pianos from this King's reign up to the present time of our Queen.

Iron wire, chiefly obtained from Berlin, was used in the piano manufacturing trade for over 100 years, and was the class of wire employed when Mr. John Broadwood first joined the above-mentioned establishment in 1769. The comparatively low tensile resistance of this metal was, however, a source of trouble, and frequent breakages resulted, especially in the smaller sizes of wire; further, the ultimate permanent elongation in iron wire was another element of difficulty.

The manufacture of steel wire in this country dates from somewhere about 1750, and not many years after Mr. Webster, of Birmingham, directed attention to its suitability for strings of musical instruments. Later, this gentleman supplied Messrs. Broadwood & Sons with their first steel wire used in their manufacture of pianofortes. In 1824 Messrs. Webster & Sons were well known in the steel music wire trade. Soon afterwards Mr. Horsfall joined the firm, and in 1854 this gentleman invented "patented or improved" tempered cast-steel music and rope wire. About the year 1862 Professor Pole was engaged by Messrs. Broadwood on experiments with steel music strings, and again in 1867, when it was noted that 24 in. of No. 17 P.W.G. had increased half an inch in length when drawn up to the required pitch, and after this elongation its tensile resistance was decidedly augmented.

Messrs. Broadwood and other similar manufacturers now obtain their best steel music wire largely from Pohlmann, still a maker of world-wide reputation in this branch of the wire industry. Some of this class of wire has an

ultimate tensile resistance equivalent to from 140 to 160 tons per square inch of sectional area. Notwithstanding this extraordinary tenacity in any form of steel, combined with a high elastic limit, the wire is further very tough and quite capable of being twisted round the tuning keys, which are of small diameter. Further, the elasticity of the wire is clearly demonstrated by the length of time that modern pianos remain in tune, an achievement which could not exist if the strings were liable to permanent elongation under the severe tensions to which they are subjected. The great strains exerted upon piano wires will be readily appreciated when it is understood that the aggregate tension upon the strings of a modern "concert grand" varies from 17 to 20 tons. In that portion of a piano where normal lengths of wire, between four and five octaves, exist, the tension averages about 170 lb. to a string, or 510 lb. for each note of three strings. In the bass, where the strings are necessarily shortened, the tensile strains are still higher. Take one of Messrs. Broadwood & Son's iron concert grand pianos, in which the total tension on the notes is 16 tons 9 cwt. 2 qr., and we shall find the lengths of the vibrating portions of the steel strings vary between 70.9 in. and 1.8 in., whilst the sizes range from 21½ to 16½ gauge. The individual tensions on these wires rank from 160.9 lb. to 144.4 lb. Thus a string with a clear span of 24½ in. and a tension of 149.9 lb. gives the note C, whilst a reduction in the length to 12¼ in. with the same tension produces the octave, the philharmonic pitch of C being represented by 540 double vibrations per second. Take the note E, produced by three strings of 21 gauge with a vibrating length of 65 in. and a tension of 157.6 lb. on each, and we shall be able to appreciate an example of the practical tensile resistance of steel wire; assume 21 G. here represents a diameter of .047 in., or an area equivalent to .0017 square inch, and the strain upon this fine-gauge

wire is equivalent to that produced by the weight of an average sized man suspended at one end of the same. The ultimate strength, however, of such a wire would be about 500 lb.

The above cited examples admirably supports Dr. W. Poles' opinions of some twenty-five years ago, viz., that cast-steel wire can be made to combine greater strength and elasticity than any other material in any form known. In a following chapter we shall discuss the physical and other properties of music wire at greater length.

It will be now readily apparent that the strains exerted upon suspended wires for aerial performers are really comparatively insignificant, whilst the margins of safety allowed are usually large. Some short time ago the writer tested a sample of wire supplied by such a performer, and found it to be of "plough" steel quality; the gauge was .092 in. in diameter, and the ultimate tensile resistance 1950 lb. (equivalent to about 130 tons per square inch), whilst its torsional efficiency attained eighteen or twenty twists in 8-in. lengths. Therefore with this sized wire the performer had a factor of safety of fully twelve times its breaking strain.

A beautiful and economical example of the uses of silver and silver gilt wires is to be found in the manufacture of bullion lace, filigree and spangle work for decorating ecclesiastical and ministerial robes, &c. The decorations and ornaments of theatrical costumes are usually made of wires of yellow metal or composition. In these industries silver wire as fine as .0015 in. in diameter is frequently used, but after drawing it is flattened out by special rollers so as to present a greater covering surface. This metallic ribbon is then spun round silk and subsequently worked into tassels, fringes, scrowls, lace, and other decorative designs. "Spangles" are perforated little discs of bright metal, largely used upon theatrical dresses, and are made

by hammering out small rings of wire formed by cutting up axially a close spiral of wire wound around a mandril.

The art of producing flat gilded wire for decorative purposes appears to be of very old origin. A wire "flatting mill" was used in Breslau as early as 1450, although it is probable that such appliance was not known in this country until 1663, or until the first mechanical wire mill was erected at Sheen.

Nuremberg figures conspicuously in the history of fine wiredrawing of precious metals, although it is stated by some recognised authorities that the French first introduced this art into this district about the year 1570. Early in the present century a wire filigree cross was to be seen in an abbey in Paris which was alleged to have been made by St. Eloy, who lived about the year 660. Gold thread tassels have been discovered amongst the ruins of Herculaneum, but probably the art of producing these fabrications was introduced into Europe from Eastern races, such as the Turks, Armenians and Indians. Augsburg produced some celebrated work of the nature under consideration in the year 1770. A history of Sumatra, published in 1783, records and extols the ingenuity of the Malays in this class of work. Spangle making is stated to have originated in France and was imitated in Germany in the beginning of the seventeenth century, and the process of their manufacture was long kept a secret. Wire "flatting" mills were first procured from the Milanese, and their production was considered a high art. It is also recorded that a firm, Fournier & Held, amassed a substantial fortune by the manufacture of "flatted" gold and silver wire in Germany during the seventeenth century. In Beckmann's History (of 1817) reference is made to the advantages of flattened wire, as covering in this state three times as much silk thread as in the round form.

"Flatting" mills are costly pieces of mechanism, al-

though one only occupies a space of about $1\frac{1}{2}$ cubic feet. At present Messrs. Krupp, of Essen, are famed makers of this class of apparatus.

Silver and silver gilt wires are usually drawn from a rod of the plain metal, or upon which gold leaf has been attached, measuring about 2 ft. 6 in. long by $1\frac{1}{2}$ in. in diameter, and weighing some 300 oz. to 400 oz. Such a rod is manipulated continuously until it is drawn down to fine wire many hundreds of miles in length. The force of this statement will be more apparent when it is mentioned that silver wire running 2000 yards to the ounce is an every-day commercial production in this branch of the wire industry.

Most fine wire is now drawn through perforated or drilled gems held in plates, an invention ascribed to Brookedon in 1819.

In a subsequent chapter we shall have occasion to consider fine wiredrawing of precious and other metals at greater length.

Those readers who may be interested in the application of wire for lightning conductors, should consult the reports of the Lightning Rod Conference of 1882, and which incorporate views on the subject by such learned bodies as the Institution of British Architects, the Society of Telegraph and Electrical Engineers, the Meteorological and Physical Societies, &c. The Delegates of this Conference formulated much valuable matter appertaining to the protection of property from damages by lightning.

Many experiments have been conducted in Europe with the view of employing wire in connection with the construction of heavy ordnance. The French in 1871 were the first to scientifically apply the method. Since, guns up to 10-in. bore or calibre have been manufactured at Woolwich with wire breech coils. Messrs. Krupp, of Essen, have also made guns of similar character with apparently satis-

factory results. At our Government arsenal rectangular steel wire, $\frac{1}{4}$ in. broad by $\frac{1}{16}$ in. thick, with a tensile value of 90 to 100 tons per square inch, has been employed, whilst Messrs. Armstrong, Mitchel, & Co. have tried milder qualities of steel wire, *e.g.*, 60-ton quality. The French, however, have used "plough" steel wire with a tensile efficiency equivalent to 120 tons per square inch of sectional area.

Passing from an application of wire to the manufacture of offensive weapons of warfare, we will next turn our attention to a use in connection with defensive appliances. At the present time most large vessels in the British and other navies are equipped with netting as protective measures against the impact and discharge of movable torpedoes. Each of such nets are about 20 ft. or 15 ft. square and are composed of a number of woven steel wire grummets connected together by intermediate wrought steel rings. These nets are tested to withstand an impact of from 6 to 8 tons. In connection with this invention, as well as that of flexible steel hawsers, the name of Messrs. Bullivant & Co. will be deservedly familiar to many.

Amongst the most recent and novel applications of wire, perhaps none has greater interest to the mechanical world than that presented by the new wire flywheel lately erected at the Mannesmann Tube Company's Works, Germany. Heavy flywheels driven at high velocities obviously present dangers of breaking asunder from the great centrifugal force developed. The wheel at the factory mentioned consists of a cast-iron hub or boss, to which two steel-plate discs or cheeks, about 20 ft. in diameter, are bolted. The peripheral space between the discs is filled in with some 70 tons of No. 5 steel wire, compactly wound round the hub, and the tensile resistance thus obtained is far superior to any casting. This huge flywheel is driven at a speed of 240 revolutions per minute, or a peripheral velocity of about 2.8 miles per minute, which is nearly

three times the average speed of any express train in the world. The length of wire upon such a constructed fly-wheel would be about 250 miles.

Sufficient has now been written to appeal to a wide class of readers, and to demonstrate that the application of some branch of the wire industry is of daily occurrence and service to both sexes of every community. Young members of the fair sex may recognise the benefits of wire articles in connection with their daily toilet and attire, *e.g.*, in the form of pins and hair pads, or in bonnet shapes and dress improvers, &c., whilst the older ones may appreciate its uses in the form of knitting and other needles to a pair of spectacles.

We will here pause to briefly consider the general physical properties of metals essential in regard to the industry before us. In the manufacture of wire, metals possessing high degrees of ductility and tenacity are obviously most desirable, indeed, the comparative "drawing" qualities or efficiencies of metals are mainly dependent upon the combined degrees of these properties. That is to say, the capacity metals exhibit for changing their molecular form under the influence of tension and squeezing pressure, and the resistance they possess to the separation of their molecules or parts during such process. Gold, silver, platinum, iron, copper, zinc, tin, and lead is the ductile notation of these metals, whilst steel, iron, copper, platinum, silver, gold, zinc, tin, and lead is their order of tenacity. Tenacity has more influence upon the ductile efficiency than upon the malleability of metals. With the exception of iron the tenacity of metals decreases as the temperature rises.

The following is considered by Ganot the usual order of efficiency that these metals should assume through the rolling mill and drawplate respectively, *i.e.*, if they are pure: Gold, silver, copper, tin, lead, zinc, platinum, and

iron; platinum, silver, iron, copper, gold, zinc, tin, and lead. Gold takes precedence in malleability. The property of divisibility in metals is also closely allied to that of ductility and malleability. For example, at the Exhibition of 1851 Gillott, the well-known steel penmaker, showed sheets of metal rolled to 1800th of an inch in thickness; again, gold-beaters work out ribbons of metal 1 in. wide and 150 in. long, to form 2000 leaves 3 in. square. In precious metal drawing, a rod of silver weighing some 20 lb. may be coated with gold in the proportion of, say, 100 grains of the latter to 1 lb. of the former metal, and these may be drawn out together for several hundred miles in lengths, until the gold is attenuated some 800 to 1000 times, and this is still further divided or extended by the process of flatting before described. Another example of divisibility may be cited in connection with the modern manufacture of superior coppered upholstery springs and other wire. After cleaning "hanks" or coils of large-sized steel wire by washing in an acid bath, they are submerged for a few seconds in a solution of sulphate of copper, whereby the wire is coated with a minute film of metallic copper, so thin that its presence cannot be detected, much less determined. Yet this wire can be drawn down to fine gauges with a perfect film of bright copper retained upon its surface throughout its various stages of attenuation.

The chemical, physical, and mechanical considerations involved in the manufacture of different kinds of wire are as important and almost as numerous as its applications. In the first chapter of this treatise we shall discuss the required properties of certain metals, and the chemical composition of different wire billets, and then pass on to examine furnaces and rolling plant, &c., employed in the hot processes of the manufacture. We will next proceed to consider the interesting operation of wiredrawing metals in the cold state and apparatus employed in this

department of the industry. In due course the more or less occult processes of annealing, hardening, and tempering will be discussed, and practical illustrations given to elucidate their effects. Later we shall devote attention to bare electrical conductors, and the chemical and physical properties of certain metals employed for such purposes. Throughout the treatise more heed will be necessarily given to the manufacture and uses of iron, steel, and copper wires than those formed of rarer metals and alloys, otherwise the available limits of this volume would be largely exceeded.

A matter of importance that will be hereafter discussed at some length is that of gauges for determining the sizes of wire, a subject of recognised interest in the trade, and one that in days gone by involved vexatious disputes and complications.

Those readers who are desirous of obtaining a more exhaustive description of the "gauge question," with its early adherent troubles and confusions, should peruse Thomas Hughes' pamphlet on "Wire Gauges," published in 1879, and the correspondence on the subject that appeared in "The Ironmonger" from 1880 until early in 1883.

Fortunately in 1884 the Board of Trade formulated and legalised a uniform standard wire gauge for this country, and since this date no other denominations are legally recognised within our Kingdom.

www.libtool.com.cn

SECTION I.

THE MANUFACTURE AND USES OF WIRE.

CHAPTER I.

IRON AND STEEL WIRE.

WIRE is produced in principle by rolling down ingots or bars of highly heated metal into rods, say $\frac{1}{4}$ in. in diameter, which are afterwards attenuated and reduced in sectional area by "drawing" them in a cold state through holes in metal plates or stones with the assistance of suitable solid or liquid lubricants. As the latter process proceeds, the metal under treatment becomes gradually harder and less ductile, and therefore it has to be periodically softened or annealed by the application of heat so as to release the molecular tension thus occasioned. After each "annealing" the wire is cleansed by washing in an acid solution, and then it is usually steeped in lime water. The processes of rolling the heated and drawing the cold metal are now effected by means of mechanical appliances which will hereafter be described. The periodical softening of the wire at various stages of its treatment in the cold state consists in heating the same within suitable air-tight furnaces or pots to a bright red heat, and then allowing it to cool slowly. The lubricants used for facilitating the drawing process may be at first of solid or semi-solid and afterwards of liquid characters, termed "dry and wet methods" respectively, *e.g.*, as soap or grease and mucilaginous or farinaceous solutions. &c. The rods or wires are

“drawn” or pulled by mechanical power through a series of perforated plates, presenting tapering cylindrical apertures of decreasing areas, so as to cause an increase of length at the sacrifice of thickness or sectional area. No appreciable diminution of weight in any given quantity of metal thus operated upon is, however, noticeable.

Iron and steel wire is usually drawn through steel plates or dies, whereas the more precious metals, and finer wires, are commonly manipulated through drilled stones or gems. For a considerable period iron wire was largely produced and almost exclusively used for numerous purposes, but within the last fifteen years or so steel has superseded its employment to a very large extent. The scientific distinction between these metals or their lines of demarcation is still a difficult and, in a measure, undecided matter. Manifold discriminations, both chemical and physical, have been proposed and drawn in the nomenclature by both theorists and manufacturers with different results. Perhaps, however, no more practical definition of steel exists than an alloy of iron which will harden and temper when quenched with water at red heat. Before proceeding to consider the manufacture of iron and steel wire, it is necessary to take an elementary glance at the generic characteristics of these metals and methods of production which determine their nomenclature as recognised in the industry before us.

Iron occupies the first place amongst the metals for strength, lightness, and utility, and is susceptible of wide variations of character according to treatment to which it may be subjected. The metal is extracted from its ores in the form of cast iron, and by subsequent judicious treatment with heat and atmospheric air may be converted into steel, or by the continued action into wrought iron. The first conversion represents an alloy of iron, carbon and manganese forming the hardest, strongest, and most elastic

material known, whilst the latter is a material possessing great strength and toughness combined with softness and ductility resulting from the practical elimination of the carbon and foreign substances.

In the wire industry this metal is usually to be found in the forms of "puddled and charcoal iron wire." The former is produced by refining pig and scrap iron in a reverberatory furnace, so as to expel carbonaceous and other impurities. When the metal has attained a pasty consistency, caused by agitation during continued heat, quantities are collected upon a puddler's "rake or rabble," termed "balls or blooms," and placed under steam hammers for beating out any retained slag. The blooms usually weigh about 60 lb. each. After hammering the metal into a compact mass, it is removed to a "puddle mill" or train of ordinary construction to be rolled into bars or rods. By the treatment above described bars containing some 99 per cent. of iron with only about .3 of carbon may be obtained, but a superior quality is required for what is known as "best bar or wire iron." Ordinary puddled iron may have a tensile resistance as low as 8 to 10 tons per square inch, whereas "best bar" may have a strength exceeding 25 tons. This superiority in quality is obtained by cutting up the common puddled metal into suitable lengths and placing the pieces upon each other in a reheating furnace, a process termed "faggotting," where they are raised to a welding heat, and afterwards again rolled out into bars. For the manufacture of wire these bars would be rolled into small rods by a "wire mill," and subsequently be drawn down, in the cold state, through perforated plates, as already described. "Puddle iron" wire is soft and pliable, but is a very inferior material to that known as "charcoal iron," the best qualities of which are made from "Swedish pig," which also furnishes the best basis for the manufacture of superior grades of steel.

Best Swedish iron is extracted from the famous magnetic ores of Dannemora by charcoal fuel, and its excellence has world-wide reputation. These ores yield from 30 to 60 per cent. of metallic iron in company with sufficient quantities of silica and lime for smelting purposes, the metal ultimately obtained being often so pure that scarcely a trace of phosphorus or sulphur can be detected, *e.g.*, 0.01 of the former and from none to 0.04 of the latter element. Steel employed in the manufacture of superior music and other high-grade wire is largely made from Swedish iron.

Ordinary "charcoal iron" is manufactured by an analogous method to that described for obtaining puddled metal, only charcoal fuel is employed in the refining process instead of coke, which imparts some sulphur to the metal; 100 parts of pig iron usually yield from 85 to 90 per cent. of refined iron, the balance representing the impurities eliminated during treatment. Charcoal iron wire is still largely used, and in the United States of America it finds an extensive field in the construction of ropes employed in connection with passenger lifts or elevators.

The manufacture of steel has undergone rapid strides and changes during the last twenty years. It has been already stated that steel is an alloy of iron, and that difficulties arise in presenting a clear logical line of distinction between the two; however, the nomenclature is practically dependent upon the amount and condition of carbon present in the metal, and which determines the physical properties of hardening and tempering. Soft steel may be usually taken to present a tensile resistance of 25 to 30 tons per square inch of sectional area, mild 30 to 40 tons, and hard steel about 40 to 50 tons respectively, although when considered in the form of wire these tensile efficiencies may be enhanced fully threefold. A usual chemical definition of these qualities may be approximately as follows: steel containing under 3 per cent. of carbon is commonly considered

“mild,” and above this temper “high carbon steel.” In the wire trade, however, much depends upon the subsequent processes by which the metal is treated, as will be later on explained.

Before considering the properties of steel which concern the subject of this treatise, we will pause to briefly examine the different methods of producing the metal, and which determine the conventional names or brands of the various kinds of steel used in the wire industry. Practically, Messrs. Bessemer and Siemens inaugurated the steel age, and in 1855 the first-named invented a process of blowing air through molten pig iron contained in a receptacle termed a “converter,” and whereby the carbon and sulphur present were burnt out. At this stage of the process some 10 per cent. of spiegeleisen (mirror iron) was added, or a proportionate amount of ferro-manganese. The metal was then poured into moulds to form ingots, called “Bessemer steel.” Spiegeleisen is roughly composed of some 80 per cent. of iron, 10 per cent. of manganese, and 4 per cent. of carbon, and its introduction into the molten metal encourages the passage of sulphur and silicon into the slag by virtue of the manganese present. Steel manufactured in a “converter” provided with a “ganister or acid” lining is termed “acid Bessemer,” and similarly “basic steel” that obtained from a converter lined with basic material, such as dolomite. By the former process, however, only pure qualities of iron can be successfully treated, whereas according to the latter inferior iron, rich in phosphorus and sulphur, can be well dealt with. Messrs. Thomas and Gilchrist introduced basic linings for Bessemer converters in 1878, and subsequently succeeded in making good steel from pig iron containing from 2 to 3 per cent. of phosphorus; the lining acting on this element, under heat, so as to form a fusible slag. Sometimes “basic steel” is known by the alternative “Thomas-Gilchrist steel.”

It may be here pointed out that the presence of either phosphorus or sulphur in steel used in the wire trade is usually very detrimental.

The "Martin process" of making steel consisted, roughly, in melting malleable and pig iron together, whereas "Siemens" comprised working pig iron with rich oxides in lieu of "scrap" or malleable iron. The two processes were afterwards amalgamated, and the steel manufactured according to the method then derived the name of "Siemens-Martin or open-hearth steel," the latter definition referring to the class of furnace used and peculiar to the process. At present, pig iron, scrap, rich oxide of iron, and some spiegeleisen or ferro-manganese, are fed at proper intervals into an open refractory basin provided within a reverberatory furnace arranged on the regenerative principle. The basin or "open hearth" is usually lined with sand, but when it is required to treat impure iron, it may be lined with calcined dolomite, the resulting manufacture then being known as "open hearth basic steel."

"Crucible cast steel" is usually produced by melting "blister or cemented steel" with some carbon and manganese in refractory pots, the nature and degrees of heat used and extent of carbonisation allowed, &c., playing important parts in the manipulation. The ordinary capacity of the crucibles may range from 40 lb. to 60 lb. charges, and various qualities of "blister bar" may be utilised as the base, but "Swedish blister" is recognised to produce the highest qualities of steel. Some blends may contain other kinds of bar iron and steel, or scrap usually admixed in suitable proportions with carbon and oxide of manganese or "spiegel." "Blister steel" is obtained by heating bars of best malleable iron in contact with charcoal within a closed furnace or chamber. The quality of cast steel in a measure depends upon the temperature at which it is poured

and therefore experienced men are required for this manufacture.

This class of steel is of very uniform and compact granular texture, presenting high degrees of tenacity, and is therefore selected for the manufacture of "plough" steel, music and other superior steel wires. The production of crucible cast steel is practically confined to Sheffield and the locality.

We will now consider the functions performed by the different elements present in iron and steel.

The presence of carbon is essential for obtaining hardness and elasticity, or in other words the quality of "temper" is dependent upon this element or the molecular changes it controls. Ingot iron or steel containing about .2 per cent. of carbon, will take a certain amount of temper, but the degrees of hardness vary with the temperature to which the metal is raised and that of the refrigerating medium into which it is plunged. Iron probably merges into steel between .17 and .2 per cent. of carbon. Iron and steel commonly used in the wire trade may range from 0.1 to 1.0 per cent. in carbon, *e.g.*, about .4 would make steel spring wire; similarly .5 ordinary rope wire, .6 piano, and .8 per cent. plough steel wire, &c., but the "tempers" would be varied with the kinds of steel employed, and the manner it is to be subsequently treated in the drawing mill, tempering, and "patenting" appliances, &c., as later on described. When considerable toughness is required the percentage of manganese present plays an important part, and in some cases it may range as high as .5 to .7 per cent.; indeed, this element stands second for usefulness as an alloy with iron in steel. Manganese imparts toughness and neutralises brittleness or "shortness;" it further acts in favour of the presence and functions of the carbon. Silicon can only be tolerated in very limited quantities, whilst phosphorus and sulphur are the greatest enemies encountered in the manu-

facture of steel. Any excess of silicon produces brittleness, which is more marked as the percentage of carbon is raised. Small quantities of sulphur present in steel will produce unsoundness and "red shortness," whilst phosphorus is detrimental on account of causing "cold shortness," besides being an enemy to any form of tempering and conductivity.

The last element may further promote greater hardness than that favourably caused by carbon. To sum up, carbon and manganese constitute the useful alloys of iron; the limited presence of silicon has to be regarded with caution and judgment, whilst sulphur and phosphorus may be dismissed as highly deleterious elements. The expression "shortness" is intended to convey a form of brittleness, similar to that found in a carrot. Small quantities of chromium, tungsten, titanium and copper are sometimes to be found in steel; however, they are not usually sufficiently pronounced to necessitate their discussion in this treatise. Within the last few years, Mr. Hadfield, of Sheffield, has introduced low carbon steels, containing from 7 to 20 per cent. of manganese, and whereby a hard, tough and non-magnetic metal is obtained, but as this alloy is not yet known in the wire trade, it may be dismissed without further comment. When carbon is found chemically combined in steel the metal is hard; and conversely, when it occurs in a free state it is softer, although the element in each condition may be uniformly diffused. The process of annealing liberates the carbon, whilst hardening (by suddenly cooling) prevents such internal separation. In tempered steel the carbon is found in an intermediate condition. Those interested in this department of the industry, and desirous of obtaining more exhaustive particulars concerning the useful and peculiar functions of carbon in steel, should read the recently published results of Sir Frederick Abel's experiments made on the subject.

The fusibility of steel increases with the amount of carbon present. This alloy is also less liable to oxidation

than iron, except when in the presence of other metals, *e.g.*, chromium : it further resists magnetism more than iron, but when so influenced it becomes a permanent property. The most important characteristic of steel, bearing on the industry we are considering, is, however, that by its use fully four times the strength of iron can be obtained for equal weight. Further, with such increase of tensile resistance there is a proportional increment of elasticity and flexibility. Some good qualities of steel wires may exhibit an elastic efficiency up to within 75 or even 80 per cent. of their ultimate strength, whilst iron wires would, under similar straining influences, commence to permanently elongate at about half the above limit of elasticity, or say 40 per cent. of their breaking strength.

The specific gravity of iron and steel may be taken on an average to range from 7.6 to 7.8.

Oxidation of iron and steel is a property of important bearing to the wire and wireworkers' trades, because such large surfaces are exposed in proportion to the sections of metal. Iron and steel when exposed to air or moisture, take up oxygen, and thus form a deposit of hydrated ferric oxide ; rusting is augmented by the presence of sulphuretted hydrogen, chlorine and most acids, whilst alkaline substances and solutions, *e.g.*, those of ammonia, potash or soda, are considered as preservatives. The presence of sulphur facilitates oxidation, whilst phosphorus retards such action. Steel rich in carbon is acted upon more slowly than iron or milder grades of the alloy in question; by the action of salt water proto-chloride of iron is formed.

In due course we shall have occasion to consider the application of zinc coatings, as a preservative measure against the oxidation of iron and steel wires.

The iron and steel ingots or bars supplied by manufacturers to wire rod rollers are termed in the trade 'billets,' and they usually weigh from about 80 lb. to

200 lb. each, their sectional areas ranging from about $1\frac{1}{2}$ in. to 4 in. square.

At Fig. 1 is represented the forms and areas of some Bessemer steel wire rod billets, as supplied to the trade by the Darlington Steel Company; their "tempers" commonly range from .10 to .5 per cent. carbon, whilst the other elements are kept low, *e.g.*, not exceeding .05 per cent. in phosphorus, .06 sulphur and .07 silicon. Buyers usually specify the "tempers" required, and the manufacturers

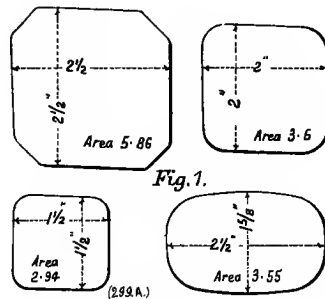

control the presence of the other elements. Some rod rollers, however, take the precaution to prove, by chemical analyses, that they have been furnished with the class of billets required. Others may specify that the total impurities present shall not exceed four-tenths of one per cent., which gives 99.6 per cent. of metallic iron.

The North-Eastern Steel Company are large manufacturers of "Basic-Bessemer" steel billets of from 2 in. to $2\frac{1}{2}$ in. and 3 in. to 4 in. square, the former sizes being most sought for in English mills, whilst the latter find more favour in American factories. Their weights vary from 60 lb. to 212 lb. each. The "tempers" of these billets run from .04 to .50 per cent. carbon, whilst the manganese present may attain from .5 to .7 per cent. for special requirements. In all cases sulphur, phosphorus and silicon are kept as low as possible.

The Steel Company of Scotland supply the trade with

steel billets manufactured according to the "Siemens-Martin process," and of the sizes above mentioned, although they find in this country 70 lb. to 80 lb. are the weights usually most preferred. The "tempers" average from 0.1 to 0.9 per cent. carbon, and the manganese from 0.3 per cent. upwards.

Messrs. Merry & Cuninghame, of Glengarnock, are eminent makers of the last-mentioned class of "billets" and who also manufacture on the "Bessemer-Basic" as well as the "Siemens-Martin acid process." The quality of steel supplied by this firm is largely what is known as, "dead soft," that is "tempers" under 0.10 per cent. carbon. The chemical analysis of this quality runs about as follows:—

Carbon	from	.08 per cent.	to	.10 per cent.
Manganese	"	.30	"	.50
Phosphorus	"	.04	"	.08
Sulphur	"	.03	"	.06
Silicon	"	nil.	"	nil.

For electrical or telegraph wire their analysis generally shows the following composition; carbon .06 per cent.; manganese .15 per cent.; phosphorus .04 per cent.; sulphur .04 per cent.; silicon nil.

Messrs. Henry Bessemer & Co., of Sheffield, supply steel wire billets of from .10 to 1 per cent. carbons, manufactured by both the Bessemer and Siemens' acid process, of which the following is an average range of analysis.

Manganese	from	.750 per cent.	to	.900 per cent.
Sulphur	"	.040	"	.060
Phosphorus	"	.030	"	.050
Silicon				trace.

For some special purposes the manganese may be as high as $1\frac{1}{2}$ per cent. This eminent firm furnishes a large quantity of billets for making various kinds of steel spring wire and umbrella ribs, &c.

Wire rod billets containing over .6 per cent. of carbon

are largely derived from the Sheffield manufactures of cast steel amongst whom the firm of Messrs. Andrews & Company will be familiar to many. "Cast steel billets" usually weigh from 40 lb. to 60 lb. each, and may contain carbon ranging from about .6 to, say, .9 per cent.; similarly, manganese from say, .2 to .6 per cent. Crucible steel being costly it is only employed in the manufacture of superior wires of high tensile resistances, *e.g.*, high-class rope and piano wire, &c. Of late years "Bessemer" steel wire has largely superseded that formerly composed of puddled and charcoal iron, which in its turn, in company with "crucible" steel, has been much replaced by "Siemens-Martin" steel wire. A great quantity of "Basic" iron and steel rods is annually produced in this and European countries for manufacturing soft wire for numerous purposes; amongst such applications perhaps that used for fencing wire being most important. In this country the Lilleshall Company is amongst the largest producers of this class of wire rods, the chemical composition of which may be as follows:—

Carbon	from	0.10	per cent.	to	0.12	per cent.
Manganese	„	0.40	„	„	0.50	„
Phosphorus	„	0.04	„	„	0.06	„
Sulphur	„	0.05	„	„	0.06	„

From the above analyses it is apparent that the quality cited is so mild that it can scarcely be classified amongst the steels, although it is practical to manufacture this material up to .2 per cent. of carbon. This and other examples given appear to support the contention that steel is more dependent upon the condition than the amount of carbon present. However, basic iron or steel wire is only advocated for purposes requiring softness and pliability, and is not considered capable of being properly hardened or tempered as other steels.

It will therefore be now understood that whereas a very soft wire can be obtained from Bessemer basic iron or steel,

which will not temper in the true acceptation, conversely, harder grades can be derived from that produced by the acid process, which will stand hardening and tempering to satisfactory degrees. However, the latter quality does not constitute a good "dead soft" material such as previously referred to, although it is sufficient for the manufacture of ordinary rope, brush and umbrella, &c., wires.

The following table gives the approximate average breaking strains or ultimate tensile resistances of wires manufactured from the classes of iron and steel previously described.

	Tons per square inch of sectional area.
Black or annealed iron wire	25
Bright hard drawn ditto	35
Bessemer steel wire	40
Mild Siemens-Martin steel wire	60
High carbon ditto (or "improved")	80
Crucible cast-steel improved wire	100
"Improved" cast-steel "plough"	120
Special qualities of tempered and improved cast-steel wire may attain	} 150 to 170

The rolling of "billets" into rods for wiredrawers, apparently originated with the Germans in the beginning of the present century, and the earliest mills were driven by water power. At this time plain cylindrical rolls were employed for the purpose of forcing the heated metal through gauge plates provided with square, oval and round holes, but the production was only something comparatively small.

By the year 1850 great progress had been made in Europe generally concerning the manufacture of wire rods and in appliances relating thereto.

The Snedshill Company, Salop, was amongst our early pioneers of the industry, their first rod mill being erected in about 1838. Messrs. Johnson & Brothers (now Johnson & Nephews) started in the same line of business. In 1863 Messrs. Pearson & Knowles, of Warrington,

entered the trade, and to-day have probably the finest rod mill in this country. However, both our output of rods and machinery employed in their manufacture are inferior to the achievements of the United States of America. Wire rods are at present usually rolled at one heat to No. 5 gauge, some makers, however, reduce them as small as No. 8.

Before proceeding to examine the construction and capabilities of modern wire rod rolling plant, it will be interesting and instructive to pause and consider some of the progressive stages through which the manufacture has passed. Over a quarter of a century ago the billets were reduced in sectional area, by treatment in a special mill, to say about two inches square, before being passed into the rod train, consisting of a series of rolls similar to an ordinary mill for rolling bars and angle-irons. An early class of mill used in the rod trade is that known as the "Belgian train" and many manufacturers in this country to-day still retain this old type of plant. In principle, such a mill is composed of a series of rolls, presenting decreasing apertures of various sections, *e.g.*, square, diamond, oval and circular shapes, and the bar of hot metal is fed to and fro from one set to the next by manual labour. The different shaped grooves in the rolls serve to knead the heated iron or steel into a homogeneous mass, before it is finally squeezed through the adjustable finishing rolls with semi-circular recesses. As the bar leaves each pair of rolls, it is turned by men provided with suitable tongs, so as to present a change of surface to the succeeding set. Such an arrangement obviously requires men on both sides of the mill to receive and return the bar or rod during its different stages of rolling. European manufacturers are little, if any, ahead of us in regard to the employment of improved rod mills, but the Americans have made considerable progress although it will be directly pointed out that their innovations originated from this country. In the rod trade of the United

States automatic continuous mills are largely used, and in some two or more rods are rolled simultaneously. However, the principle of continuous rolling was invented and patented by George Bedson, of Manchester, as early as 1862, and resulted in an arrangement of mill which will be understood upon reference to Fig. 2 of the illustrations. Bedson advocated feeding the heated bar or rod from one set of rolls to the next automatically, and which were so arranged that a fresh surface should be presented for treatment. The diagram only represents one set of a series of rolls, but it will be seen that a rod emerging from the

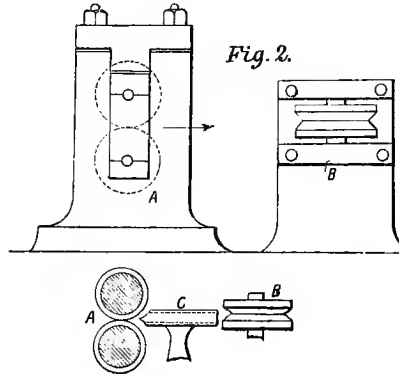

319A.

horizontal set A was received by another set B, at right angles to the same, *i.e.*, arranged upon vertical axes. This contrivance obviously removed the necessity of turning the rod periodically during its transit through the mill. The detached sectional plan indicates the method he proposed for guiding the rod from one set of rolls to the succeeding ones. It consists in the employment of channels or tubes C arranged between the series as shown. The specification describes the uses of various shaped grooves for kneading the metal from square to diamond, oval and circular sections and nine "passes" are explained from the bar to the finished

rod. Bedson further claims, as a modification, the use of a spiral pipe for turning the bar. This gentleman died in December, 1884, and so important was his career in relation to the progress of the wire trade, that we cannot consistently pass it over without a few words of respectful comment. George Bedson was born at Sutton, Warwickshire, in November, 1820. In 1839, he entered the employ of a Warrington firm of wire manufacturers,* and in 1851, he joined the staff of Messrs. Johnson & Brothers of Manchester (now Messrs. Johnson & Nephew), where he remained until his death. Mr. Bedson was the inventor of important improvements in puddling furnaces and rod mills, besides originating in 1860 a system for continuously galvanising wire.

In 1872, J. Bleckly, of Messrs. Pearson & Knowles, patented some valuable improvements in wire rod mills, as shewn by the engraving, Fig. 3, and which discloses another important step towards the continuous system of rolling

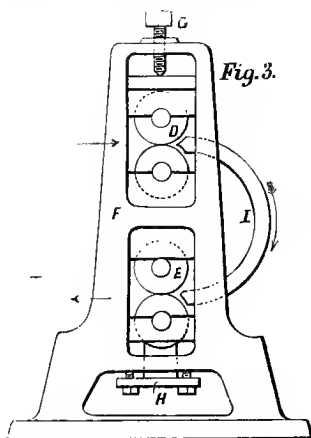

now in vogue in the United States. According to this arrangement, the rolls D and E are superimposed, so that a bar or rod passed through the first or top set is turned backwards by the curved passage I so as to be automatically

* Messrs. James Edleston & Co., and not Messrs. Rylands Brothers.

fed into the lower set. The working parts are suitably carried by the framing **F**, whilst the proper relative position of the rolls may be adjusted by the screw devices shown at **G** and **H**. A "rod train" would be composed of a series of such rolls, driven at increasing speeds through the intervention of suitable spur-gearing, in order to promptly take up the slack caused by the continually increasing lengths of the rods as they are diminished in thickness. Mr. Bleckly was probably the first to use gravitation platforms in connection with rod mills, a system now largely adopted in America.

In this country, billets of from 70 lb. to 80 lb. weight are preferred by our rod rollers, with the exception of those required for furnishing rods for the manufacture of telegraph and rope wire, which then may attain some 150 lb. weight. In the United States the billets manipulated are frequently over 200 lb. each, and obviously the greater the weight of metal treated, the longer the rod obtained, and the ultimate continuous length of wire that may be drawn from it. At the present time, the billets are usually reduced to rods at one heat.

Amongst our modern mills, probably no better examples can be cited than that of Messrs. Pearson & Knowles' or Messrs. Johnson & Nephew's. The former plant is to be seen at the Dallam Iron and Steel Works, Warrington, and is capable of rolling from 370 to 400 tons of No. 5 G. rods per week. The billets used, average from 120 lb. to 150 lb. weight and are manipulated at one heat. The construction of this mill is practically according to Mr. Bleckly's invention of 1872 previously described with reference to Fig. 3, and may be termed of a semi-continuous and automatic type, as manual labour is dispensed with on the one side of the rolls. The mill is driven by straps and appropriate gearing, so that each succeeding set of rolls may receive an increasing speed, requisite for taking up the slack caused by the rolling out or extension of the rods.

Some parts of this train make as many as 600 revolutions per minute. The peripheries of the rolls are formed with different shaped grooves for the purpose of obtaining compactness in the metal as already described, and the whole series are capable of accurate adjustment, so as to reduce the rods in definite proportional stages as required. During the rolling, from the billet to the rod, the heated metal may be squeezed through, say, ten to twelve different rolls, termed "passes." As the finished rods leave the mill, they are wound upon a suitably arranged drum, to form coils or "hanks" ready for the wire drawers.

So far as output and price of production are concerned, some important rod mills may be seen in Germany at the works of the Westfälische Union, Menden Schwerte, and the Dusseldorfer Draht Industrie, &c.

We will now take a brief glance at the more continuous rod rolling practices of the United States of America, and with such object will pause to examine a "Garrett mill" as illustrated at Figs. 4 to 7 inclusive.

Mr. Garrett was born in Scotland, but has been many years now in the States, where he has achieved a leading reputation in connection with the subject at issue. His invention relates to arrangements of rolling plant for treating or reducing the "bloom" to the "billet," and so on through the various stages to the finished rod, at one heat, by a continuous rolling operation. In this manner it will be understood that a bloom some 4 in. square may be reduced to a billet, say, 1½ in. square, and this in its turn be automatically conducted through the mill, so as to be ultimately delivered as a rod many hundred feet long. Re-heating during the process of rolling is always objectionable, as it involves loss of time and waste of metal by reason of oxidation. Now, by the employment of mills of the class we are considering, the bloom is taken from the furnace and treated, continuously at one heat, until it is

reeled as wire in the hot state at the opposite end of the mill. The rapidity with which these operations are now conducted may be such that before one rod has left the rolls another bloom is started in the billet mill. According to a modification two or more grooves may be provided in the rolls, so that a number of rods may be rolled simultaneously.

Fig. 4 represents a ground plan showing the general arrangement of a mill in question, whilst the other figures drawn to an enlarged scale represent elevations of the billet, intermediate, and rod trains. Referring to

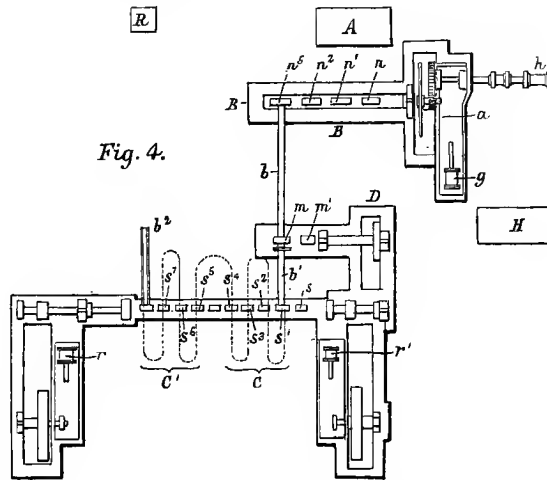

the first figure, H indicates the ingot furnace, from which the heated metal is taken to the bloom train *h*, worked by an engine *g* and suitable gearing *a*. The bloom is then cut into convenient lengths and reheated in the furnace A. The highly heated bloom is then passed to and fro successively through the rolls *n* to *n*³ of the billet train B, driven by spur gearing and provided with grooved rolls, as shown in Fig. 5. From the last of this series the bar is conducted to the intermediate train D (Fig. 6) by the medium of a pipe or channel *b*, where it is reduced

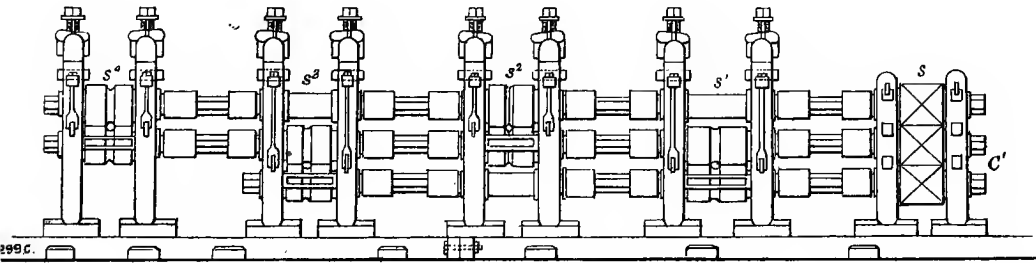
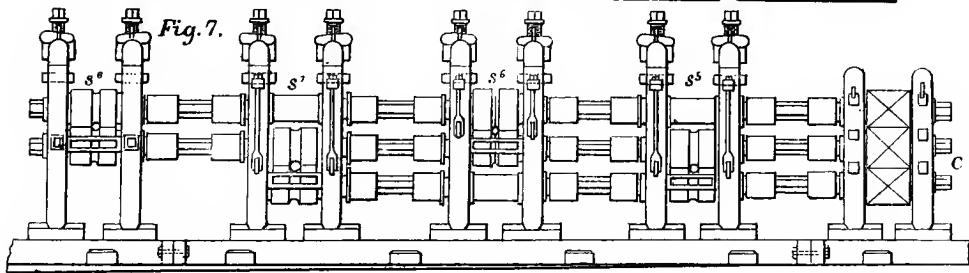
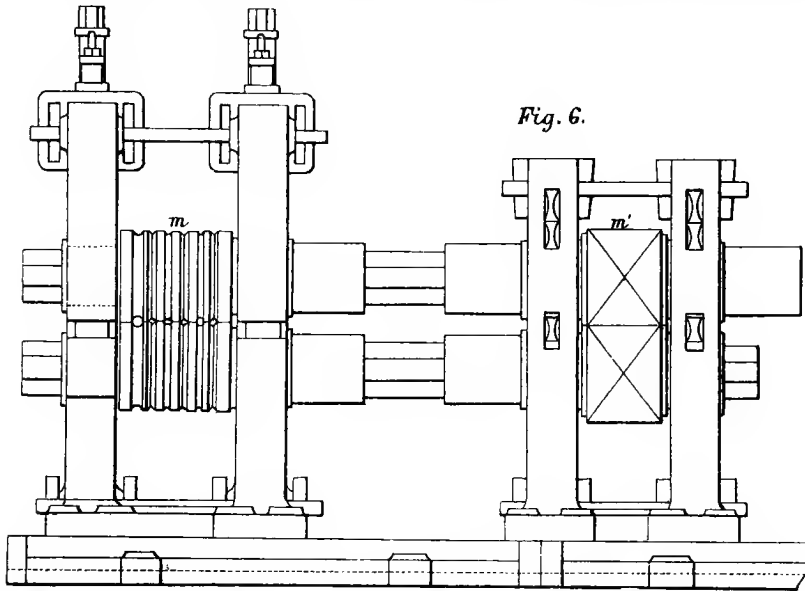
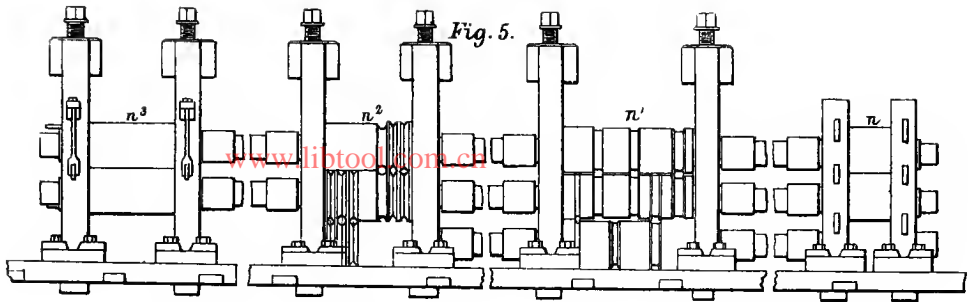

www.libtool.com.cn
by the rolls m , driven by the pinions m^1 , previously to being carried on by the tube b^1 to the finishing or rod train c, c^1 , formed of a series of rolls s to s^8 , Fig. 7. This set is actuated by the engine and gearing $r r^1$. The finished rod is delivered from the rolls s^8 , and conducted by the trough b^2 to the reeling mechanism R, and by which the hot wire is wound into coils. The original lengths of the blooms may be some 2 ft., whereas the finished rods may measure some 600 yards long. This attenuation at the sacrifice of sectional area requires some nice adjustments and proportioning of the component rolls of the mill. The curved dotted lines shown in the plan on either side of trains $c c^1$ indicate the manner in which the rods are received from one set of rolls and returned to the next by tongs manipulated by manual labour. Garret, in concert with one Morgan, of Mass., U.S.A., has since improved upon this mill in order to render its action more automatic. At the present time curved horizontally inclined troughs or channels are provided—in the form indicated by the dotted lines above referred to—for the purpose of receiving the bar or rod as it leaves one set of rolls, and mechanically returning the same to the next series without the assistance of attendants. Or, in other words, a horizontal deflecting and turning channel is provided between the rolls, in a similar manner to Bleckly's vertical device described with reference to Fig. 3 of the illustrations.

A good typical example of an automatic continuous wire rod-rolling mill, arranged on the American principle, may be seen in daily operation at Messrs. Roebbling's extensive works at Trenton, New Jersey. The general arrangement of this mill is similar to that already described. The diameters of the rolls range between 9 in. and 12 in., and their speeds from 70 to 500 revolutions per minute. Gas producers and re-heating furnaces arranged on Siemens' principle are pro-

vided for raising the billets to a white heat, and one of these is taken out at a time, by means of a pair of tongs connected to a chain terminating with a pulley running in an overhead inclined guide. In this manner the furnaceman is readily enabled to withdraw a heated bar and carry it to the billet mill, whence it passes onward through several separate trains of rolls, through the intervention of curved turning channels placed between the same and straight leading troughs from one train to the next as previously described with reference to Garrett's mill. Practically the whole process is conducted continuously and automatically, with the exception of at a few places where the rods, when of oval section, tend to ride over their guides, and here they are assisted by manual labour in the usual way. The weights of the billets used at this mill range from 120 lb. to 150 lb. each, and two or three rods are rolled simultaneously. The rolls of the billet mill run at about 70 revolutions per minute, and the intermediate trains from 150 to 250 revolutions per minute, the metal making altogether 18 "passes" from the billet to the finished rod which is usually of No. 6 gauge. This mill is capable of rolling 50 tons of rods in nine hours.

One of Garrett's best mills is to be seen at the Joillet Steel Works, near Chicago, Ill. The Cleveland Iron & Steel Rolling Mill Co., Ohio, has produced by one of such mills 150 tons of wire rods in twenty-four hours. The American Wire Co., in the same district, has manufactured by a Morgan continuous mill 1500 tons of No. 9 rods per month; the billets used in this production were four inches square, and weighed 210 lb. each, and the speed of the finishing rolls was 1200 revolutions per minute. It has been previously pointed out that an output of from 200 to 400 tons of rods per week in this country is considered a fair production. On the other hand it should be understood that the American system of rolling two or three rods in one mill at the same time does not produce so accurate a

result as that obtained from the older types which roll only one. The former method may do well enough for producing fencing and common wire, but European wire-drawers would be anything but pleased to receive such rods for the production of superior qualities. The usual desideratum after all is to roll wire rods accurately to gauge and of uniform sectional area. The average lengths of wire rods range from 200 to 600 yards in length, *e.g.*, take a No. 5 S.W.G. rod .212 in. in diameter, rolled from a billet of, say, 70 lb., this would produce about the former, whereas a 200 lb. billet would give about the latter length. Therefore the length of such rods are dependent upon the weight and material of which the billets are composed and the gauges to which they are rolled. Take the case of a billet weighing 1 cwt., which, if rolled to a No. 5 S.W.G. rod, would give 322 yards in length, and this might be further attenuated by drawing to say No. 20 G., giving 11,200 yards in length.

Rods thus produced by rolling in the hot state, are then made into wire by the process of "cold drawing" through perforated plates as previously described in principle. For this purpose they are pointed at one end by hammering upon an anvil or by insertion into a machine designed for the purpose in order to obtain a tapering point capable of being introduced into the conical holes of the "draw-plates." The rods are now cleansed by washing in a bath of dilute sulphuric or muriatic acid, and afterwards are immersed in lime water to give a drawing surface; finally they are dried by heating within a suitable chamber.

A wire-drawing mill consists of a series of horizontal drums or pulleys A—termed "blocks"—mounted on vertical axes B upon long benches, with draw-plates and pincer devices to each, as shown by the illustration, Fig. 8, which represents two detached "blocks." The draw-plates E, which are pierced with a regular gradation of tapering

holes, are held in vices or clamping frames fixed to the bench, as shown, whilst the mechanical pincers D are provided for catching hold of the tapering extremities of the rods inserted into the holes of the plates for pulling

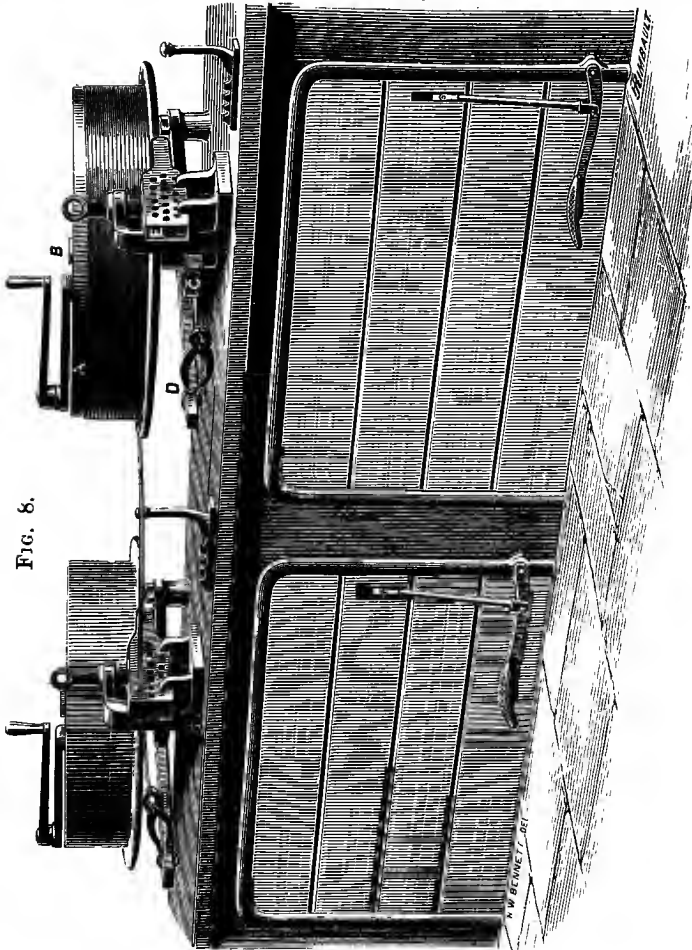

FIG. 8.

them through, the pincers being forced backwards by revolving cams C fixed on the drum spindles. When a sufficient length of any rod has been thus drawn to enable a turn being taken round a drum, the drawing process is

continued by this means. Wire thus attenuated may have to be redrawn in a similar manner a number of times, dependent upon the gauge required, the process being facilitated by the application of lubricants termed "wire drawers' soap and grease." These saponaceous and fatty lubricants are commonly used in most practices down to, say, 18 or 20 gauge, when liquids such as soapy water, milk, farinaceous fermented liquors, &c., are usually substituted. These methods are known as the "dry and wet processes" respectively, and already referred to. In cases where straw-tinted wire is not objectionable, or may be required, a weak solution of sulphate of copper is used as the drawing liquor. In each case the object sought is to obtain a lubricant which will coat the wire with a mucilaginous or metallic film so as to preserve it from oxidation and thus leave a bright and polished surface. However, as these drawing operations proceed the wire becomes proportionally harder, so that the wire has to be annealed at certain stages of the process. In practice, wire to be drawn to a fine gauge is sometimes returned about half a dozen times to be softened. The "annealing pots" are simply metal chambers into which the wire is placed and hermetically sealed during the process of heating for several hours at a red heat, and which is afterwards allowed to cool down slowly in the same. An average-sized pot will receive about 50 cwt. of wire at one charge. Finally annealed wire is softer and more pliable than that bright finished or drawn; steel wire, however, requires some different treatment to that employed for iron. The drawing-drums before referred to are of various sizes—say from 30 in. to 10 in. diameter, and may be driven at speeds of about 500 ft. to 700 ft. per minute for the production of ordinary wire; but crucible and "patented" steel wire should be drawn at a slower speed, in order to prevent breakages. The drums used for taking the first "draws" on the rough rods are termed "ripping blocks," and are of

large diameters and strong construction, whilst the speed of driving is usually rather lower than that above-mentioned; but this, however, is dependent throughout upon the sizes of the blocks and the classes of wires to be drawn. The drums of small-sized blocks may be driven at a velocity of some 600 ft. or more per minute for drawing soft wires. "Fine wiredrawing" is usually considered those gauges below No. 20, although it may be used simply in a comparative sense. In the Lancashire works the "pulleys" are usually subdivided into "ripping, nine, twelve, and nineteen blocks," the respective speeds of which for drawing homogeneous iron and mild steel might be about 50 in., 65 in., 85 in., and 100 in. per second. Fine wiredrawing in iron and steel, *i.e.*, gauges from Nos. 21 to 50, is chiefly confined to the Yorkshire mills. When the holes in the steel draw-plates have become enlarged by wear, the plates are heated and hammered up and partially repunched, the requisite diameters of the holes being ascertained and adjusted by the insertion of gauge punches. Some kinds of wires are tempered before drawing, others during or after this process.

In this country superior grades of wire are produced by drawing through the entire series of graduated holes in the plates consecutively, and the form and rate of remuneration is such that no inducement is given to wire-drawers to "jump holes." With the exception of continuous wiredrawing, the men are usually paid so much per hundredweight, according to the gauge and number of "passes" made through the plate or mill, extra charges being allowed for drawing tinned, coppered, or bright wire, and those of special sections.

A wire-drawers' union exists in this country to discuss and determine the interests of the men engaged in the industry, but which, however, has been defeated twice within the last ten years by the necessary demands of our manufacturers. A skilled or experienced wire-drawer

knows fairly well what intermediate holes in the plates may be omitted if desirable, and the tractive force necessary to produce certain results which obviously vary according to the material being treated and the gauge required.

After each annealing the wire is cleansed from scale by washing in an acid solution, termed "pickling," and as previously mentioned. This process is still universally adhered to, although it is recognised to possess detrimental features. From time to time mechanical methods of cleansing have been advocated and tried, but apparently without success. Iron when heated in the presence of atmospheric air tends to oxidise rapidly, and therefore it is very necessary to exclude air as far as possible from the annealing pots, into which the wire is placed in the form of "hanks" or coils. As the presence of scale or oxidation thus occasioned absorbs power and causes jerking in the process of drawing (besides injuring the drawplates) much care has to be exercised to insure the wire being properly cleansed by the treatment before described.

Probably a temperature of from 600 deg. to 700 deg. Fahr. is not only sufficient, but the best heat for annealing purposes, *i.e.*, for neutralising the molecular tension in the wire caused by drawing. The time occupied for uniformly heating the wire and then allowing it to cool down slowly necessarily depends upon its gauge and the quantity treated. In this country 2 to 3 tons is the usual charge, but in some American works it exceeds 5 tons. After repeated annealing there is a tendency for the wire to become somewhat permanently softer by virtue of slight decarbonisation.

It has been already mentioned that the processes of rolling and drawing wire effect some extraordinary alterations in the physical characteristics of metals, and whereby a great increase of tensile resistance is produced. Such physical or molecular changes are admirably demonstrated

by Mr. H. Allen's recent experiments and research.* This gentleman found that a mild steel billet with .115 per cent. of carbon, giving a breaking strain of 28 tons per square inch and 28 per cent. of elongation, exhibited the following remarkable alterations after manipulation in a rod mill and draw-plate. By the first process the elastic limit of the steel was increased 45 per cent. at a sacrifice of elongating efficiency, and the ultimate tensile resistance augmented 14 per cent. The specific gravity of the metal was naturally raised by rolling, as its component molecules were compressed into more intimate relation, and which may account for the enhanced properties of elasticity and tenacity pointed out. Mr. Allen then observed that by annealing, the condition of the metal reverted nearer to that exhibited in the original or billet form. These experiments and investigations supported the contention that by rolling the elasticity and tenacity of the steel was increased one-third and one-eighth respectively, whilst the property of extension was reduced one-fourth.

The rods were rolled to No. 5 G., and pieces taken from these were afterwards drawn down to Nos. 6, 8 and 10 G., without annealing, and by which the attenuation was increased some 190 per cent. at the reduction of 65 per cent. of sectional area. Mr. Allen's interesting and valuable experiments showed that the elastic limit of the wire exceeded that of the drawing stress, *e.g.*, say a rod .265 in. in diameter be drawn to .220 in., the elastic limits of which were 19.9 and 30.1 tons respectively, whilst the breaking strains were similarly equivalent to 29.8 and 44 tons per square inch of sectional area, whereas the force exerted in drawing the wire was only equal to 25.8 tons per square inch. The increase of tensile strength attained by drawing the rod through one hole of a draw-plate, *viz.*, from 29.8 to

* Vol. xciv., Proceedings Inst. C.E.

44 tons value, from a billet originally possessing 28 tons per square inch breaking strain, is simply marvellous, and should serve to most clearly convey one of the notable achievements of the industry we are investigating.

In the case of the wire drawn through three holes to No. 10 G., the tenacity of the metal was increased 95 per cent. above that of the billet. These remarkable changes in the steel can only be attributed to physical or molecular modifications, whereby the particles are squeezed into compact and interlocking relationship. It will now in some measure be understood how, by similarly treating higher grades of steel, through a greater number of holes, wire can be produced with an ultimate tensile resistance equivalent to over 170 tons per square inch of sectional area.

With reference to the last remark, we may here to advantage examine the valuable experiences disclosed by Dr. Percy in 1886, with regard to the tenacity of high-carbon steel or "plough" wire. Here it may be explained that the term "plough" is derived from the fact that steel wire of high breaking strains was introduced by Mr. Fowler for the construction of ropes used for steam ploughing purposes.

The steel wire employed in Dr. Percy's investigations was supplied by Messrs. Fowler & Co., of Leeds. Its specific gravity was 7.814, and its chemical analysis, gauges, and tensile efficiencies were as below:

Carbon, 0.828 per cent.; manganese, 0.587 per cent.; silicon, 0.143 per cent.; sulphur, 0.009 per cent.; phosphorus, nil; copper, 0.030 per cent. No traces of chromium, titanium, or tungsten were found. The breaking strains of the wire are given in the following Table:—

Diameters in fractions of an inch.	broke in pounds equivalent to	Tons per square inch of sectional area.
0.093		154
0.132	" "	115
0.159	" "	100
0.191	" "	90

It will be noticed that as the diameters of the wires increase the tensile strengths are diminished, a result which points strongly to the physical virtues developed by drawing.

The chemical analysis was made by Mr. Deering, and the mechanical tests were conducted by Col. Maitland, R.A., both of Woolwich Arsenal. The elongation of the wire in question was from 1.1 to 0.75; no torsional tests were taken. The lengths of the pieces experimented upon varied from 100 in. to 50 in. A correspondent of Dr. Percy's, however, did not consider the above results exceptional, and therefore called attention to some tests made with tinned and bright steel wire 10 in. in length, and which showed ultimate tensile efficiencies equal to over 190 and 169 tons per square inch respectively. The average breaking strains were over 160 tons, whilst the sizes of the wires ranged between .018 in. and .03 in. in diameter, the percentages of elongation varying from 1.0 to 2.8. The metal from which Dr. Percy's wire was made was in the form of best crucible steel, supplied by Messrs. Firth & Co., of Sheffield. It should not, however, be overlooked that high tensile efficiencies are obtained at the sacrifice of toughness, therefore anything over an equivalent to 150 tons breaking strain is not of much practical value. It should also be borne in mind that no two pieces of wire can be relied upon as having precisely the same physical properties.

Enough has now been written for the reader to understand that steel wire of great elasticity and tenacity can be obtained by manipulating such high carbon alloys of iron, whilst softness and toughness may be conversely achieved by employing mild and basic steels. In the manufacture of the former class the processes of tempering and "improving" play important parts, as will be later on explained.

Here it may be mentioned that common salt has been claimed to possess valuable properties for assisting the processes of wiredrawing. Some American authorities

www.libtool.com.cn

state that wire drawn through brine and lime water can be reduced with greater ease than by any other method, and by way of example it is recorded that a steel wire .192 in. in diameter, coated with salt, has been drawn down to .078 in. in six passes.

For the present the manufacture of high qualities of steel rods and wire is not much attempted in the United States, *e.g.*, such as used for superior rope, music, pinion, watch-spring, drill, or card wire, &c. It is satisfactory to reflect that in the wire competition for the East River Bridge, New York, U.S.A., Messrs. Johnson & Nephew, of Manchester, submitted samples of steel wire which exhibited ultimate tensile resistances up to 206,170 lb. per square inch; whilst the strongest American wire broke at 194,227 lb. per square inch, the respective rates of elongation being .0440 and .0380.

This English firm was not only able to attain such excellence in manufacture, but was further able to compete with American quotations after paying a very heavy import duty. The prices in this competition ranged between 8 and 14 cents per pound, Messrs. Johnson & Nephew's offer being based upon 13½ cents per pound.

"Patented or improved steel wire" implies that which has been treated by a patented or special "improving process" of annealing, hardening, and tempering, and whereby a suitably selected quality may have its tensile efficiency increased two or threefold, without much detriment to its ductility, but at some sacrifice of toughness. "The patenting or improving" of steel wire is rightly held to be an occult process in the trade, for each manufacturer has his own, more or less, special method and devices for attaining the same object, and upon such experience, skill, and judgment the excellent quality of certain wires largely depends. Mild steel wire for, say, carding purposes, would be differently treated to those of higher tempers for pro-

ducing rope, or piano wire, &c., but the following general information may be taken to convey an idea of the processes in principle.

Fig. 9 represents a steel wire improving plant consisting of the annealing furnace A, hardening vessel B, and tempering bath C. The wire *a* is conducted at a proper uniform rate of speed through this serial apparatus by means of tubes *d*, so as to prevent, as far as possible, the detrimental effects of impinging air and products of combustion. D represents a pulley or drum by which the wire is drawn through the apparatus. The annealing furnace A shown is of ordinary construction, but in practice it might be arranged on Siemens' or other regenerative or gas-pro-

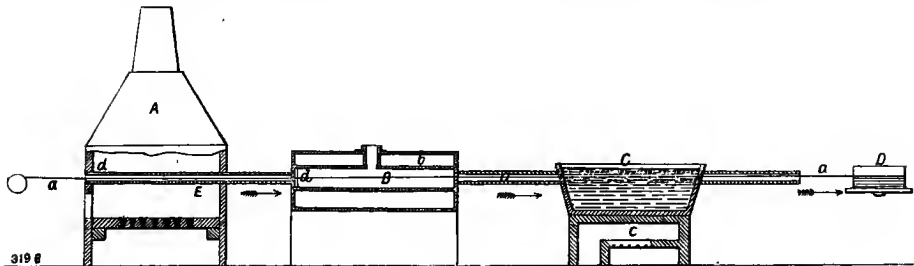

FIG. 9.

ducing principles, &c. The hardening bath here consists of an annular chamber B filled with oil maintained at a low temperature by means of the water-circulating jacket *b*, whilst the tempering contrivance illustrated comprises a bath of molten lead *c*. It will be now understood that the wire is first softened in the furnace, then hardened by passing through the cold oil, and finally tempered by immersion in the molten metal. In lieu of molten lead mixtures of lead, zinc, antimony, tin, and bismuth have been employed. The changes which occur in the wire during such treatment are of a molecular or physical nature, and the process is usually applied before final drawing. Carding wire may be annealed by gas jets, hardened in oil, and

www.libtool.com.cn
finally tempered by gas flames, but in all cases air and products of combustion have to be kept from impinging upon the wire, and the success of the process is mainly dependent upon the material used, the adjustment of proper uniform temperatures, and the time allowed for treatment. Sometimes gas or charcoal are chosen instead of coke for heating the furnaces and baths. According to some methods coal gas or carburetted hydrogen is introduced into the annealing and tempering chambers in order to exclude the presence of oxygen or atmospheric influences. Others have advocated annealing wire by means of electric currents. Products of combustion, such as sulphur, are highly detrimental if allowed to come in contact with the heated wire. Mild steel wire may be carbonised or toughened by passing it through heated charcoal dust. To prevent the oxidation of molten metal used in tempering baths, the surface may be covered with asbestos or powdered charcoal. The use of slack lime has been tried for the purpose of avoiding the oxidation of the heated wire as it passes through the "inuffle" tubes and chambers. Instead of the application of cold oil for hardening purposes, cold water, air, and metal plates have been used for some specific requirements, and likewise heated beds of sand resorted to for tempering purposes. Again, admixture of steam and volatile hydrocarbons have been employed as gaseous fuels—free from smoke and impurities—for heating annealing and tempering furnaces; the subsequent hardening and tempering processes have been varied by quenching in mercury or oil, and by means of immersion in boiling linseed oil respectively, or other liquids, heated to about 600 deg. Fahr. In the manners above described it is practical to obtain hard wire from a "temper" of, say, .06 per cent. carbon, or, say, a wire .084 in. in diameter capable of making forty twists, and withstanding 1000 lb. tension; being about 80-ton quality. By way of further example

let us consider the effect of patenting or improving a mild steel rope wire of, say, 50-ton quality, capable of taking sixty turns in about 8 in. As it stands this would be an excellent class of wire for some purposes, but for rope constructions it would mean the use of an unnecessarily large gauge of wire, and consequently superfluous weight undesirable for many situations. However, by treating this wire as before explained its tensile strength may be improved or enhanced, say, 30 tons per square inch at a small torsional and elongational sacrifice.

In 1877 Professor Morris communicated to the Royal Society the results of his exhaustive experiments connected with the molecular changes which occur in steel wires during the processes of annealing, hardening, and tempering, and to which some of our readers may find it interesting to refer.

Wire requiring to be "improved" to a large extent, is usually drawn several holes after treatment, but so much necessarily depends upon its size, composition, and previous manipulation, that it is impossible to define any fixed rules of procedure.

It will be remembered that black or finally annealed wire is soft, and that bright finished or drawn wire is comparatively hard; this latter process is known in the trade as "bench hardening."

We will now turn our attention to galvanised wire, *i.e.*, wire coated with metallic zinc to preserve it from oxidation. This process consists in drawing cleansed wire through a bath of molten zinc (spelter), and whereby it retains a metallic film forming a galvanic pair or complement. By virtue of the positive properties of the zinc, this metal is attacked upon contact with air, moisture, or carbonic acid, and in this manner the iron or steel is preserved. Galvanised metal will not, however, stand exposure to acid vapours, such as produced by products of combustion, &c. It may here be

pointed out that by tinning wire the reverse result is achieved, that is to say, in the latter case the iron or steel is attacked (instead of the tin) by atmospheric influences. Zinc may be converted into a liquid condition at a temperature of about 775 deg. Fahr., and this metal alloys with the iron in the wire to a slight or superficial extent. This action is shown by the fact that a very brittle alloy is deposited in galvanising baths, known as "hard spelter," and which has been ascertained to contain some five or six parts of iron. The surface of the molten zinc is usually kept covered with sal-ammoniac for dissolving off the oxide as it forms upon the same. As the wire leaves the bath it is passed through a bed of sand or similar substance for removing the superfluous zinc which adheres thereto. George Bedson in 1860 invented a continuous system of annealing

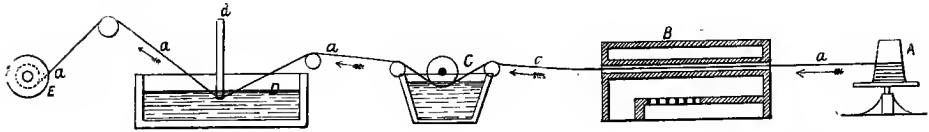

FIG. 10.

and galvanising iron and steel wire, and which is represented by Fig. 10 of the illustrations. The wire *a* is first annealed by passing it through the furnace *B*, whence it is drawn through the acid or pickling bath *C* to thoroughly cleanse it of any scale formed by oxidation, and finally it is caused to travel through the molten spelter bath *D*, and be wound upon the reel *E*. At Fig. 11 is shown in side elevation and plan a modern type of wire-galvanising plant such as now commonly used in European works.

Upon consulting these drawings it will be readily apparent that a number of coils of wire may be treated simultaneously. The wires are drawn by mechanical means first through the "pickling" tank and then through the galvanising bath, and are finally wound upon vertical

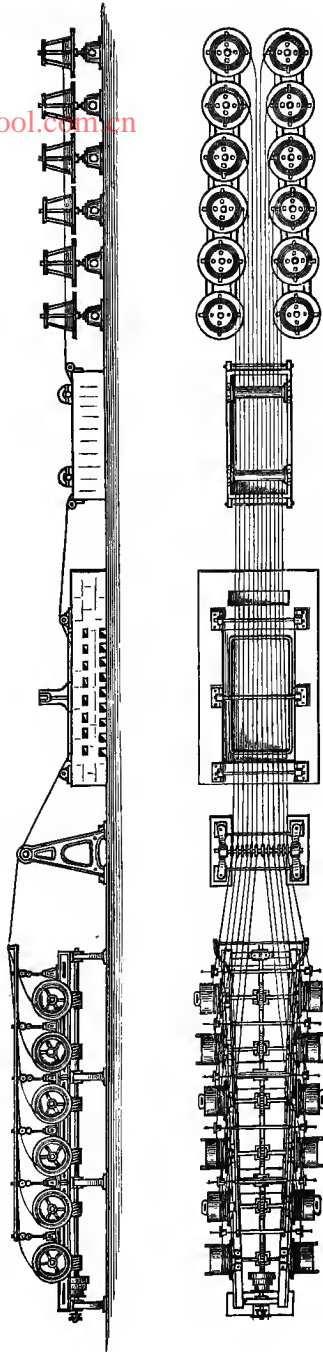

FIG. 11.—WIRE-GALVANISING PLANT.

www.libtool.com.cn
drums, driven by worm-gearing. Galvanised iron and steel wire is largely used for hawsers and rigging ropes, signal and fencing strands, telegraph conductors and submarine cables, clothes lines and other purposes where moisture or wet is to be encountered. The process, however, causes a slight depreciation in the properties of the metal.

Tinned wire is obtained in a similar manner to the process last described, only hanks or coils of wire, after cleansing, are dipped into a bath of molten tin, the superfluous metal being afterwards shaken off and a bright surface imparted to the wire by finishing it in a draw-plate. Sometimes the wire is reduced several sizes after being tinned. The surface of the molten metal is covered with 2 in. or 3 in. of tallow to protect it from oxidation. It will be understood from that which has been already stated that iron or steel tinned wire, if imperfectly coated with tin (*i.e.*, uncovered portions left exposed), it is more liable to active oxidation than plain wire, because in this case a galvanic pair is formed in which the iron is the positive element. Bright drawn tinned wire is largely used for spring mattress-making, &c., but this class should not be confused with "tinman's wire." The latter is a soft and pliable bright drawn wire used in the manufacture of various tinplate utensils and goods,

Bright coppered wire is produced by steeping hanks of steel wire in a solution of sulphate of copper, and whereby a film of metallic copper is deposited. The coated wire is then drawn down in order to give it a bright polished surface. Bright drawn coppered spring wire is largely used for the manufacture of upholstery springs.

Previous to galvanising, tinning, or coppering great care has to be exercised to effectually "pickle" or cleanse the wire intended for such treatments.

"Lacquered" or straw-tinted wire is also obtained by

drawing iron or steel through a weak solution of sulphate of copper, *e.g.*, as used for toys and fancy goods, &c.

The "tempers" of the different steel wires to be submitted to the above processes are previously determined by experience, and which in the case of rope wire might range from, say, .05 to .50 per cent. of carbon, similarly for telegraph purposes .06 to .075, for springs about from .3 to .45 per cent. of carbon, &c., but it all depends upon the material, and how it has been previously treated.

Card wire was originally manufactured from Swedish charcoal iron drawn down to about 19 G., on large blocks, when it was annealed in small ovens and afterwards cooled on brick floors. The wire was then run through an arrangement of rollers to remove the scale, and subsequently was drawn down to No. 24 G., or any intermediate size to No. 50 as required. Of recent years charcoal iron has been superseded by special qualities of steel capable of being hardened and tempered. At one time Messrs. S. Fox & Co. obtained over £50 per ton for this quality of wire drawn to Nos. 18 or 20 G. The wire has to be frequently annealed during its treatment, and draws well through lubricating leys or liquors, such as sour ale, beer bottoms, solutions of flour or soft soap, &c. Suitable lengths of the wire are then "dressed," straightened and tested for toughness and elasticity by a process of bending and twisting backwards and forwards, termed "snarling." These tests are essential in order to determine whether the wire is capable of withstanding the "plunger" in the "card setter," and which bends it at right angles into the "filletting." The "temper" of the wire has to be hard in order to withstand repeated grinding or sharpening when in the form of carding teeth. Messrs. Royston, Sons, & Co. and Ramsden, Camm, & Co., &c., are amongst the eminent firms engaged in this branch of the industry.

The manufacture of superior grades of steel rope wire is

www.libtool.com.cn

an important speciality in the trade, and amongst such makers the names of Messrs. W. Smith & Co., Webster & Horsfals, Fairbrothers & Co., and John Lord & Sons, &c., figure conspicuously. Some short time ago the writer's attention was directed to a series of tests made in April last with some of the last mentioned firm's wire, and which from the following tabulation will be seen to present a very satisfactory example of uniform quality and temper :

APRIL 8, 1889.

.089 W.G.				.082 W.G.				.072 W.G.			
Front End of coil.		Back End of coil.		Front End of coil.		Back End of coil.		Front End of coil.		Back End of coil.	
Twists in 8 in.	Strains.	Twists in 8 in.	Strains.	Twists in 8 in.	Strains.	Twists in 8 in.	Strains.	Twists in 8 in.	Strains.	Twists in 8 in.	Strains.
	lb.		lb.		lb.		lb.		lb.		lb.
34	1220	33	1230	43	960	41	985	47	725	46	740
33	1225	33	1235	44	955	42	970	49	730	45	760
33	1200	33	1210	45	945	44	950	48	735	47	750
31	1200	29	1225	43	960	40	990	48	730	46	740
30	1205	30	1210	45	950	42	970	46	740	45	755
36	1180	33	1200	47	940	45	960	47	725	46	745
35	1190	34	1210	45	960	43	980	48	730	46	740
34	1210	33	1230	46	950	44	975	48	740	47	730
37	1180	35	1190	45	965	42	990	46	720	45	750
33	1200	33	1205	43	960	41	980	47	735	45	740

These wires were made from rods of Siemens-Martin steel supplied by The Steel Company of Scotland, and the tests are recorded consecutively and not by any selection. The elongation of these wires averaged about 2 per cent.

The manufacture of piano wire constitutes a very important branch of the industry at issue, and the following are the sizes and average tests of such class of wire as made by the well-known firm, Messrs. Webster, Horsfals, & Lean.

Numbers in music wire gauge.	12	13	14	15	16	17	18	19	20	21	22
Equivalents in fractions of inches in diameters.	.029	.031	.033	.035	.037	.039	.041	.043	.045	.047	.052
Ultimate tensile strength in pounds.	225	250	285	305	340	360	375	425	500	540	650

It has been mentioned in the introduction to this treatise that Messrs. Pöhlmann, of Nuremberg, Miller, of Vienna, and the firm previously referred to, have attained a leading reputation in this branch of the wire industry. To these the names of Messrs. Houghton & W. Smith, of Warrington, are worthy of incorporation.

Below is given a Table of chemical and mechanical tests (especially prepared for the author), made with some of the best piano or music wire obtainable in any market in the world. The name of the manufacturer is placed above each test, and the writer has pleasure in acknowledging the courtesy shown him by Messrs. Broadwood & Sons in furnishing the samples in question.

CHEMICAL COMPOSITION:—	PÖHLMANN'S.	MILLER'S.	WEBSTER-HORSFAL'S.
Carbon (per cent.)-	0.640	0.740	0.570
Silicon „	0.032	0.205	0.090
Sulphur - „	Trace.	0.017	0.011
Phosphorus „	0.004	0.015	0.018
Manganese „	0.120	0.330	0.425
PHYSICAL PROPERTIES:—			
Diameters in fractions of inches -	.040	.036	.037
Torsion or turns in six inches - - -	60 to 70	30 to 40	60 to 70
Ultimate tensile strength in pounds -	400	318	340
Equivalent tension in tons per square inch -	142	140	141

The uniform quality of these wires is apparent. Miller's is a little inferior in the torsional tests, which is perhaps attributable to having the highest percentage of carbon, or from some slight lack of regular temper.

According to other tests made, some of Pöhlmann's wire

www.libtool.com.cn

broke at an equivalent to 150 tons per square inch of sectional area, and yet exhibited a torsional efficiency of some 60 twists; similarly other pieces of Webster's wire, 140 tons with 90 twists, whilst some of W. Smith's wire showed tensile and torsional resistances equal from 140 to 155 tons per square inch, and 100 to 30 turns respectively.

Some official tests made in Paris, Vienna, and the United States of America concerning the tensile strength, &c., of music wire, are now appended.

1. OFFICIAL TESTS MADE BY THE JURY OF THE INTERNATIONAL EXHIBITION, PARIS, 1867.

Messrs. Pleyel, Wolff & Co.'s Machine Used.

—	No. 13	No. 14	No. 15	No. 16	No. 17	No. 18
Moritz Pöhlmann's broke at a strain of	lb. 226	lb. 264	lb. 292	lb. 296	lb. 312	lb. 348
English wires broke at	214	274

2. OFFICIAL TESTS MADE BY THE JURY OF THE INTERNATIONAL EXHIBITION, VIENNA, 1873.

—	No. 13	No. 14	No. 15	No. 16	No. 17	No. 18
Moritz Pöhlmann's broke at a strain of	lb. 232	lb. 260	lb. 290	lb. 300	lb. 322	lb. 336
Martin Miller & Son's wire broke at a strain of	168	192	206	232	255	280

3. OFFICIAL TESTS MADE BY THE JURY OF THE WORLD'S EXHIBITION, PHILADELPHIA, 1876.

Messrs. Steinway & Son's Testing Machine Used.

—	No. 13	No. 14	No. 15	No. 16	No. 17	No. 18
Moritz Pöhlmann's broke at a strain of	lb. 265	lb. 287	lb. 320	lb. 331	lb. 342	lb. 836
W. D. Houghton's wire broke at a strain of	231	242	253	287	331	374
Smith & Son's wire broke at a strain of	221	242	242	287	320	331
Washburn & Moen's wire broke at a strain of	176	198	242	

4. TESTS MADE BY "THE MUSICAL COURIER," JUNE 4, 1884.
 Riehle Brothers' Machine Used.

	No. 13	No. 14	No. 15	No. 16	No. 17
Moritz Pöhlmann's broke at a strain of	lb. 275	lb. 290	lb. 325	lb. 355	lb. 410
W. D. Houghton's wire broke at a strain of	240	265	290	315	340
Smith & Son's wire broke at a strain of	210	210	250	255	315
Felten & Guilleaume's wire broke at a strain of	235	260	300	295	385
Washburn & Moen's wire broke at a strain of	210	235	240	270	295
Roeslau wire broke at a strain of ...	200	270	280	330	335

MEASUREMENT OF THE DIFFERENT WIRES TESTED BY "THE MUSICAL COURIER," JUNE 4, 1884.
 Brown and Sharpe's Millimetre Gauge Used.

	No. 13	No. 14	No. 15	No. 16	No. 17
Of M. Pöhlmann's make measured ...	mm. 770	mm. 825	mm. 880	mm. 920	mm. 975
„ W. D. Houghton's make measured	780	825	875	925	975
„ Smith & Son's make measured ...	790	865	900	950	955
„ Felten & Guilleaume's make measured	800	860	920	940	975
„ Washburn & Moen's make measured	800	840	860	900	960
„ Roeslau's make measured	780	840	880	960	950

DIFFERENCE IN GRADATION.

	In Strength.				In Thickness.			
	Between Nos. 13 by 14.	Between Nos. 14 by 15.	Between Nos. 15 by 16.	Between Nos. 16 by 17.	Between Nos. 13 by 14.	Between Nos. 14 by 15.	Between Nos. 15 by 16.	Between Nos. 16 by 17.
M. Pöhlmann's make ...	lb. 15	lb. 35	lb. 30	lb. 55	mm. 55	mm. 45	mm. 65	mm. 65
W. D. Houghton's make ...	25	25	25	25	45	50	50	50
Smith & Son's make	40	5	60	65	35	50	5
Felten & Guilleaume's make	25	40	...	90	60	60	20	25
Washburn & Moen's make ...	25	5	30	25	40	20	40	60
Roeslau's make ...	70	10	50	5	60	40	80	35

72 *Sizes, Strengths, and Weights of Iron Wire.*

www.libtool.com.cn

These experiments show Pöhlmann's wire to be the strongest, but Houghton's superior for combined strength and regularity of size or general gradation. Piano wire is usually sold by the lb. and not by the cwt. or ton, as customary with ordinary kinds of wire

The following table, prepared by Messrs. Rylands, Brothers, Limited, shows the sizes and equivalent weights, lengths, and breaking strains of iron wire, the gauges given being according to the "Imperial Standard" (S.W.G.), established in 1884.

Size on Wire Gauge.	Diameter.		Sectional Area in Square Inches.	Weight of		Length of Cwt.	Breaking Strains.		Size on Wire Gauge.
				100 Yards.	Mile.		An-nealed	Bright	
7/0	.500	12.7	.1963	193.4	3404	58	10,470	15,700	7/0
6/0	.464	11.8	.1691	166.5	2930	67	9,017	13,525	6/0
5/0	.432	11	.1466	144.4	2541	78	7,814	11,725	5/0
4/0	.400	10.2	.1257	123.8	2179	91	6,702	10,052	4/0
3/0	.372	9.4	.1087	107.1	1885	105	5,796	8,694	3/0
2/0	.348	8.8	.0951	93.7	1649	120	5,072	7,608	2/0
1/0	.324	8.2	.0824	81.2	1429	138	4,397	6,595	1/0
1	.300	7.6	.0707	69.6	1225	161	3,770	5,655	1
2	.276	7	.0598	58.9	1037	190	3,190	4,785	2
3	.252	6.4	.0499	49.1	864	228	2,660	3,990	3
4	.232	5.9	.0423	41.6	732	269	2,254	3,381	4
5	.212	5.4	.0353	34.8	612	322	1,883	2,824	5
6	.192	4.9	.0290	28.5	502	393	1,544	2,316	6
7	.176	4.5	.0243	24	422	467	1,298	1,946	7
8	.160	4.1	.0201	19.8	348	566	1,072	1,608	8
9	.144	3.7	.0163	16	282	700	869	1,303	9
10	.128	3.3	.0129	12.7	223	882	687	1,030	10
11	.116	3	.0106	10.4	183	1,077	564	845	11
12	.104	2.6	.0085	8.4	148	1,333	454	680	12
13	.092	2.3	.0066	6.5	114	1,723	355	532	13
14	.080	2	.0050	5	88	2,240	268	402	14
15	.072	1.8	.0041	4	70	2,800	218	326	15
16	.064	1.6	.0032	3.2	56	3,500	172	257	16
17	.056	1.4	.0025	2.4	42	4,667	131	197	17
18	.048	1.2	.0018	1.8	32	6,222	97	145	18
19	.040	1	.0013	1.2	21	9,333	67	100	19
20	.036	0.9	.0010	1	18	11,200	55	82	20

It has been endeavoured to give the sizes of wires herein-

before referred to in fractions of inches as far as possible so as to avoid reference to obsolete gauges with misleading and conventional titles, such as "Birmingham," "Music," and other like standards. The above table, however, serves to correctly describe the now only legally recognised wire gauge in this country, whilst the accompanying diagram, Fig. 12, will visibly convey an idea of the sizes at issue, in their numerical order.

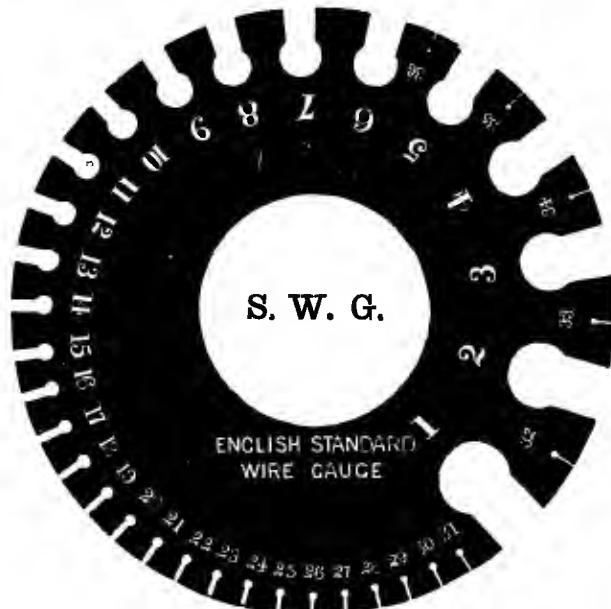

FIG. 12.

In a subsequent chapter the "Gauge Question" will be more exhaustively discussed.

The average of the specific gravities of iron and steel wire is so nearly the same, that frequently in practice any difference is ignored. For example, "The Whitecross Co., Limited," have issued a table of sizes, weights, and lengths for both iron and steel wire, which is identical to that of Messrs. Rylands just reproduced, but with additional columns for the increased breaking strains as follows:—

BREAKING STRAINS OF STEEL WIRE.		SIZE.
Annealed.	Bright.	S. W. G.
lb.	lb.	
13611	20310	7/0
11722	17583	6/0
10159	15243	5/0
8712	13067	4/0
7534	11302	3/0
6593	9891	2/0
5726	8573	1/0
4901	3751	1
4147	6221	2
3458	5187	3
2930	4395	4
2447	3672	5
2007	3011	6
1668	2530	7
1393	2091	8
1130	1694	9
893	1339	10
734	1099	11
590	884	12
461	691	13
349	523	14
284	424	15
223	334	16
170	256	17
128	188	18
87	130	19
72	106	20

When, however, it is desirable to estimate the average weight of steel wire more accurately, multiply that of 100 yards of iron wire by 1.02; but results so obtained would also slightly vary according to the quality under consideration.

For comparing the tensile and torsional strengths of wires it is usual to consider their sections in fractional equivalents of a square inch, in order that such areas may be calculated to a uniform constant, or unit of comparison. It will be evident that when the exact diameter of any wire is known, its area may be readily deduced, and after-

wards its proportion to a square inch easily computed. In Ryland's table the gauges of the wires are given in millimetres as well as decimal fractions of inches, so that it may be mentioned that in cases where breaking strains are given in kilos. per square millimetres (as on the Continent), these may be converted into tons per square inch by multiplying the same by .635. The tabulation in question only extends to sizes worked in Lancashire, *i.e.*, up to 20 G., or the demarcation where fine wiredrawing commences. The smallness of this gauge, however, will be appreciated upon reference to the illustration Fig. 12. Later on the measurement of finer wires will be considered and the use of the micrometer explained.

Some time ago "The Ironmonger" published a very useful Table, by John Lord (late of Brighouse), now of the Springfield Wire Mill, Leyland, for readily calculating the tensile strengths of wire from .270 to .001 in. diameter at one ton per square inch for each 1000th part of an inch. By the author's permission the writer is enabled to give on the following page a modified arrangement of this tabulation, from No. 5 to No. 20 S.W.G.

The use of this Table will be at once understood from the following simple example. Assuming it is required to find the equivalent breaking strain of a wire, say .04 in. diameter, in tons per square inch of sectional area, which broke at 400 lb. tension, a case as cited with reference to one of the piano wire tests previously given. Opposite this size of wire in the above Table will be found the coefficient 2.8 lb., which used as a divisor of the ultimate resistance in pounds., *e.g.*, 400 divided by 2.8 lb., will give in the quotient the equivalent strength in tons per square inch, and which in the present case is nearly 143 tons. The co-efficients for similarly computing the breaking strains of fine wire, *i.e.*, from Nos. 21 to 40 S.W.G., will be given in the succeeding chapter, which deals with this section of the industry.

Table for Calculating Strengths of Wire.

No. 5	S. W. G.		Pounds		S. W. G.		Pounds		S. W. G.		Pounds		S. W. G.		Pounds		S. W. G.		Pounds		S. W. G.		Pounds	
	Decimal	Pounds	Decimal	Pounds	Decimal	Pounds	Decimal	Pounds	Decimal	Pounds	Decimal	Pounds	Decimal	Pounds	Decimal	Pounds	Decimal	Pounds	Decimal	Pounds	Decimal	Pounds	Decimal	Pounds
.216	82.1	.198	69.	.18	57.	.162	46.2	9	.144	36.5	.126	28.	.108	20.5	.09	14.3	15	.072	9.1	.054	5.1	.047	3.8	
.215	81.2	.197	68.3	.179	56.3	.161	45.6		.143	36.	.125	27.5	.107	20.1	.089	13.9		.071	8.9	.053	4.9	.046	3.7	
.214	80.4	.196	67.6	.178	55.7	8	.16	45.	.142	35.5	.124	27.	.106	19.7	.088	13.6		.070	8.6	.052	4.8	.045	3.5	
.213	79.6	.195	67.	.177	55.1		.159	44.5	.141	35.	.123	26.6	.105	19.4	.087	13.3		.069	8.4	.051	4.6	.044	3.4	
.212	78.9	.194	66.4	.176	54.5		.158	43.9	.14	34.5	.122	26.2	12	.104	19.	.086	13.		.068	8.1	.05	4.4	.043	3.2
.211	78.2	.193	65.6	.175	53.9		.157	43.4	.139	34.	.121	25.8	.103	18.7	.085	12.7		.067	7.9	.049	4.2	.042	3.1	
.21	77.6	.192	64.8	.174	53.3		.156	42.8	.138	33.5	.12	25.3	.102	18.3	.084	12.4		.066	7.7	.048	4.	.041	2.9	
.209	76.9	.191	64.1	.173	52.7		.155	42.3	.137	33.	.119	24.9	.101	17.9	.083	12.1		.065	7.4	.047	3.8	.04	2.8	
.208	76.1	.19	63.5	.172	52.		.154	41.7	.136	32.5	.118	24.5	.1	17.6	.082	11.8	16	.064	7.2	.046	3.7	.039	2.7	
.207	75.4	.189	62.8	.171	51.4		.153	41.2	.135	32.	.117	24.	.099	17.2	.081	11.5		.063	7.	.045	3.5	.038	2.5	
.206	74.6	.188	62.2	.17	50.8		.152	40.5	.134	31.6	11	.116	23.6	.098	16.9	.08	11.3		.062	6.8	.044	3.4	.037	2.4
.205	73.9	.187	61.4	.169	50.2		.151	40.1	.133	31.1	.115	23.3	.097	16.6	.079	11.		.061	6.5	.043	3.2	.036	2.3	
.204	73.2	.186	60.5	.168	49.7		.15	39.6	.132	30.7	.114	22.9	.096	16.2	.078	10.7		.06	6.3	.042	3.1	.035	2.2	
.203	72.5	.185	60.2	.167	49.		.149	39.	.131	30.2	.113	22.5	.095	15.9	.077	10.4		.059	6.1	.041	2.9	.034	2.1	
.202	71.7	.184	59.6	.166	48.5		.148	38.5	.13	29.7	.112	22.1	.094	15.3	.076	10.1		.058	5.9	.04	2.8	.033	2.0	
.201	71.	.183	59.	.165	47.9		.147	38.	.129	29.3	.111	21.7	.093	15.2	.075	9.9		.057	5.7	.039	2.7	.032	1.9	
.2	70.4	.182	58.4	.164	47.3		.146	37.5	10	.128	28.8	.11	21.3	.092	14.9	.074	9.6	17	.056	5.5	.038	2.5	.031	1.8
.199	69.7	.181	57.8	.163	46.7		.145	37.		.127	28.4	.109	20.9	.091	14.6	.073	9.4		.055	5.3	.037	2.4	.03	1.7

www.hbz.com.cn

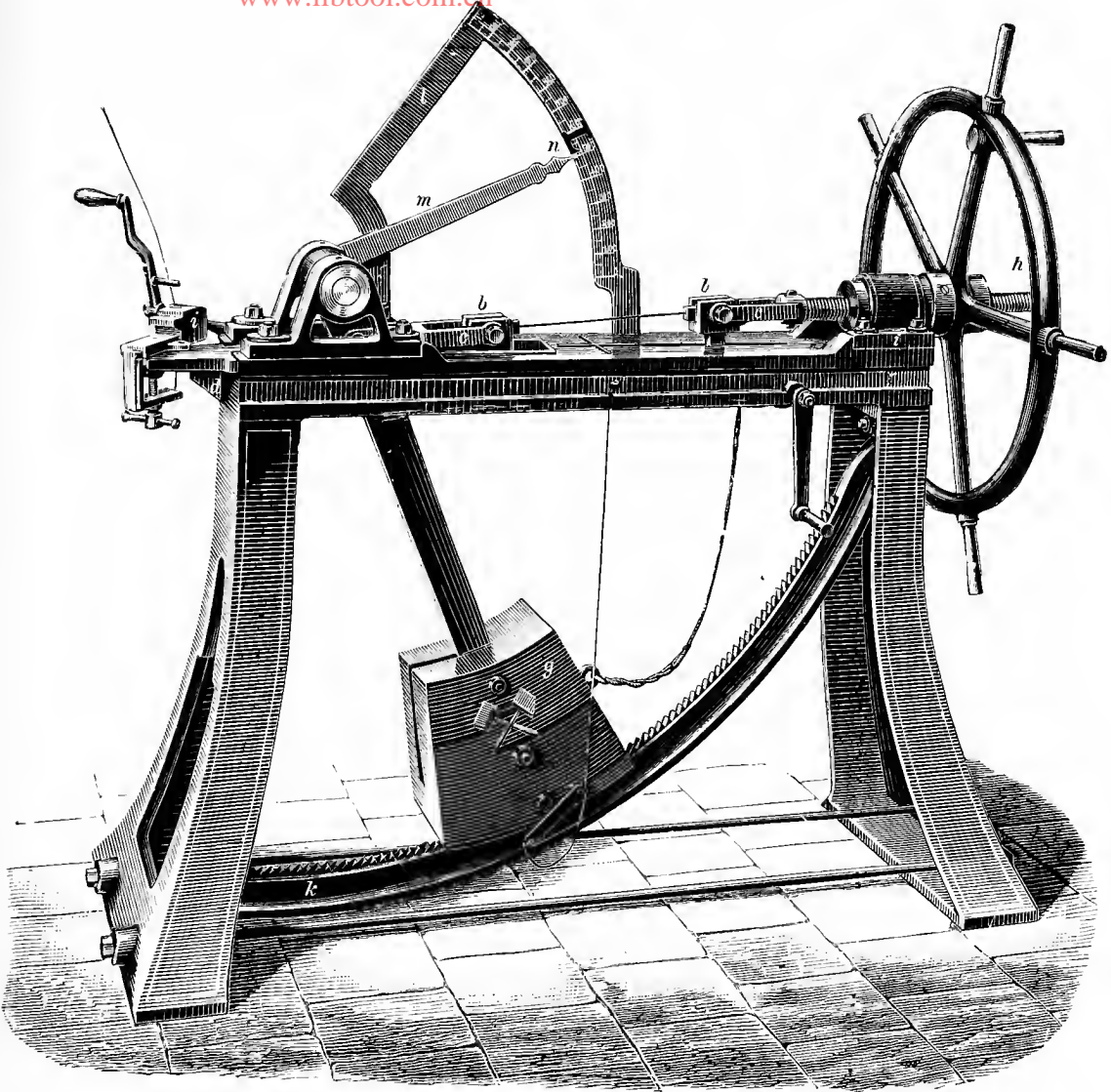

FIG. 13.— WIRE-TESTING MACHINE.

www.libtool.com.cn

Messrs. John Lord & Son have somewhat recently started their mill at Leyland, and where they appear to be turning out some creditable steel and charcoal iron wire, &c.

We will now turn our attention to some different accepted types of wire-testing machinery for ascertaining the tensile and torsional strengths of various kinds of wire. Fig. 13 illustrates a class of machine much used on the Continent, and in which g , is a counter-weighted lever provided with a pointer m , working over the divided arc n , and having connection with the link and wire clip b . The other clamping attachment is shown in connection with the screw spindle h of the handle-wheel. These wire clips b are provided with swivel actions or universal joints for the purpose of allowing automatic adjustment of the parts according to the true line of tension exerted upon the wire during testing. All the parts of the machine are compact and accessible, whilst the employment of skilled attendants is unnecessary. A piece of wire to be tested is placed between the clips b , the jaws of which automatically grip the same when the tensile force is applied or the machine put into operation, and it will be readily understood that as the counter-weighted lever g is pulled up or raised by the handle-wheel h into a more horizontal position, so is an increasing tensile force transmitted to the wire in question. A rack and detent device is provided in connection with the said lever g and the traversing arc k , so that upon the rupture of the wire the pointer or index finger m is retained in a position to indicate the breaking force exerted, and which is shown upon the graduated arc n in pounds or kilogrammes as required.

It will be further seen that, by the medium of the wheel and screw spindle h , the tensile strain can be very gradually and uniformly applied to the wire fixed between the clips. After the breaking strain has been observed or recorded, the lever g is allowed to return to its normal or

vertical attitude upon releasing the detent action by pulling the cord shown in the drawing. It is obvious that the distance between the clips will depend upon the length of wire to be tested. It is claimed that this class of machine is capable of testing 100 pieces of wire per hour.

The apparatus *i*, shown attached to one end of the framing *d*, consists of a vice and a lever provided with a projecting pin or stud and whereby the bending efficiency of any piece of wire can be ascertained. The wire to be thus tested is held firmly between the jaws of the vice, whilst the projection on the lever can be caused to move it to and fro until it breaks, the number of bends successfully accomplished being recorded for each experiment.

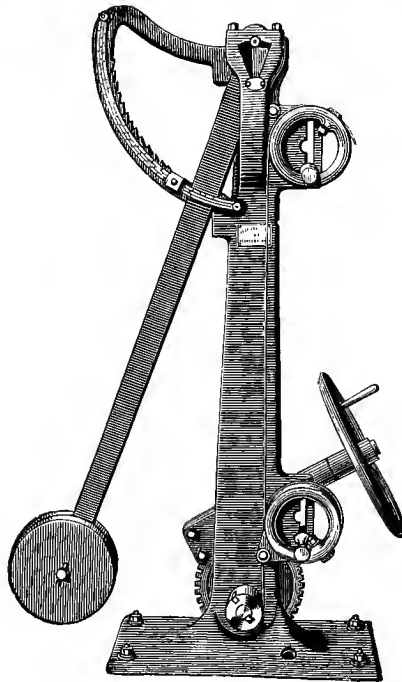

FIG. 14.

Mr. Carrington's tensional wire-testing machine, illustrated at Fig. 14, is in principle very similar to the arrange-

ment already described, that is to say, a counter-weighted lever is pulled from its vertical towards a horizontal attitude by means of a tensional strain transmitted through the wire under test. The special character of the wire holding clips will be understood upon examining the drawing. The handwheel shown exerts a gradual downward strain upon the wire fixed between the clips through the intervention of a drum and worm-gearing, the force applied being measured by the angle that the weighted lever assumes in relation to its normal or vertical attitude.

A torsional wire-testing apparatus, designed by the last mentioned inventor, is illustrated at Fig. 15. It consists in the use of a sliding and revolving clip for the purpose of

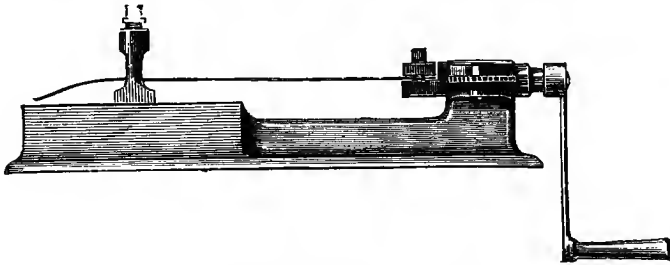

FIG. 15.

ascertaining how many twists may be taken in different wires before they rupture. The pieces experimented upon usually vary from 6 to 8 in. in length. The wire to be tested is fixed between the sliding and rotary clips and the twisting effected by means of a handle. The number of revolutions made before breakage is automatically recorded upon a dial attached to ordinary registering mechanism. The jaws of the clips are made of corrugated form so as to reduce the pressure otherwise necessary to hold it whilst testing. Several of these tensional and torsional testing machines have been supplied to various governments and manufacturers in this and other countries.

Denison's patent wire-testing machine is illustrated at Fig. 16 and consists in the employment of a lever working

about a "knife-edged" fulcrum, and carrying, upon a second knife-edge, a clipping device in which is fastened the one end of the specimen to be tested. Upon the opposite end of the lever an automatic counterpoise is provided for travelling upon the graduated "race" or scale shown. The straining mechanism comprises a slide provided with a suitable bearing for the knife-edge on the lever, which is actuated

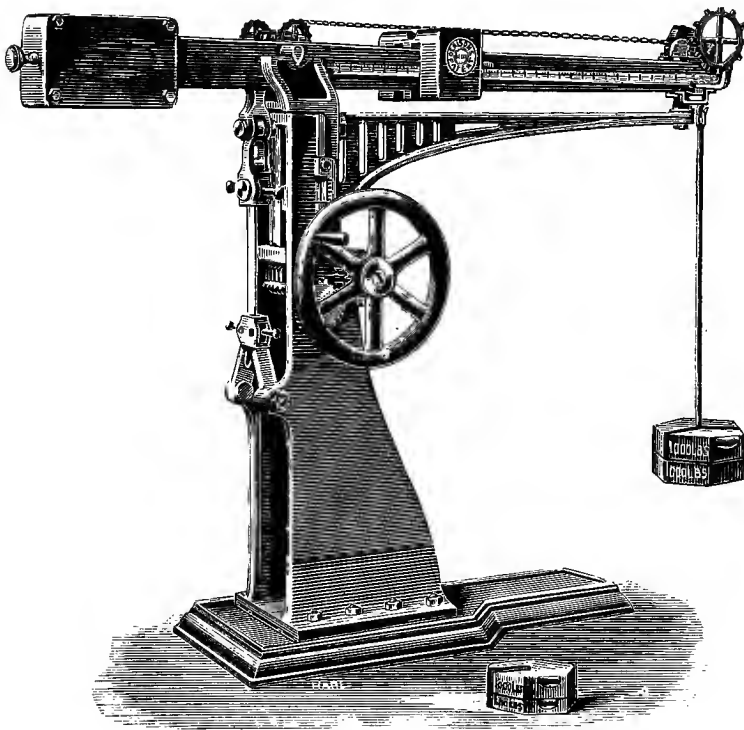

FIG. 16.

by a handwheel and appropriate gearing for raising or pulling up the said weighted lever. The lower end of the wire under test is secured in a clip bolted to the framing of the machine. The most important feature, however, in this machine is the automatic moving arrangement of the counterpoise, which is obtained by the action of the

www.libtool.com.cn

suspended weight which drives a chain attached to the travelling poise.

The chain further drives the governing mechanism, which consists of a revolving cataract of mercury and a detent wheel which engages with a stop on the lever at a certain position. The extension and point of rupture in the specimen is shown on a scale fixed to the saddle piece, whilst a vernier divided into hundredths of an inch is attached to the body of the machine. The action of the apparatus is as follows. The wire to be tested is inserted between the clipping contrivances described and the slack taken up. It is then fixed and the pointer set to zero, the travelling poise being then released from its catch. Upon turning the handwheel a downward pull is exerted upon the specimen so as to lift up the long arm of the scale lever, and whereby the detent wheel is released and the poise set free to travel. This weight continues to move until the point of equilibrium is reached, and when it is arrested by the re-engagement of the automatic detent device above described. The position of the vernier now indicates the exact amount of stress that has been applied to the wire to obtain a certain elongation or final rupture. Denison's patent wire clipping mechanism, illustrated at Fig. 17, is an improvement upon the ordinary wedge box largely used. Here the wedges will be seen to be operated simultaneously by the intervention of levers and segmental teeth, the said wedge pieces being kept apart by means of a bow spring. These machines are fitted with two speeds of gearing, *i.e.*, one for testing light wire, and another fifteen times as fast for actuating the more powerful mechanism. The testing strains are applied by means of the handwheel which actuates worm and screw gearing, so as to obtain a steady and uniform motion. Denison's machines have met with marked approval in cases where the first cost is not of primary importance.

Figs. 18 and 19 illustrate types of Kitchin's well-known tensile wire-testing machines as manufactured by Messrs. J. Slee & Co., of Earlstown. From that which has been already written respecting the construction and functions of other similar machines, further detail explanations are rendered unnecessary. In most cases the testing strains are gradually and uniformly applied to the wire, or specimens being experimented upon, by means of handwheels and appropriate gearing, the stresses being communicated to the weigh-beams or graduated levers through the medium of the wire under test, as already described.

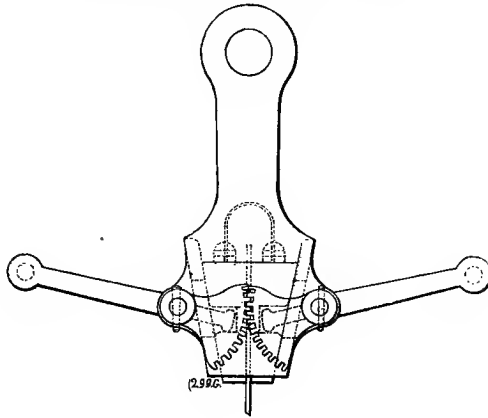

FIG. 17.

We will now turn our attention to methods of continuously drawing iron or steel wire, and with such object direct notice to S. H. Bryne's invention of 1885, illustrated at Figs. 20 to 22 inclusive. This invention relates to improvements in wire drawing and in apparatus employed for such purpose. It consists in drawing wire at one operation through a series of rotating dies provided with suitable arrangements for effectual lubrication. Previously, however, to examining the details of this ingenious process, it will be interesting to pause and briefly consider some matters concerning the general initiation of continuous wire-

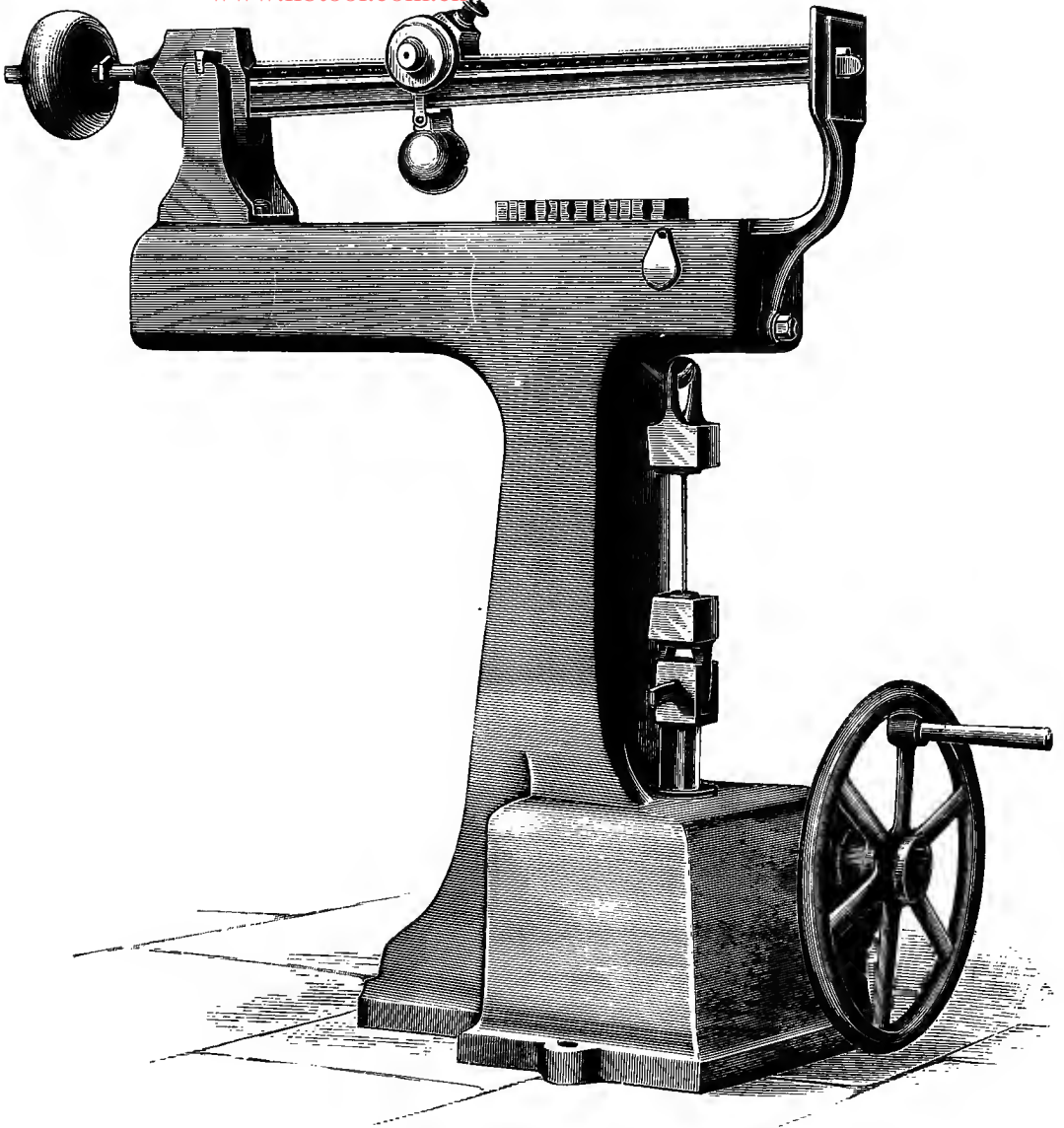

FIG. 18. KITCHIN'S WIRE-TESTING MACHINE.

www.libtool.com.cn

www.libtool.com.cn

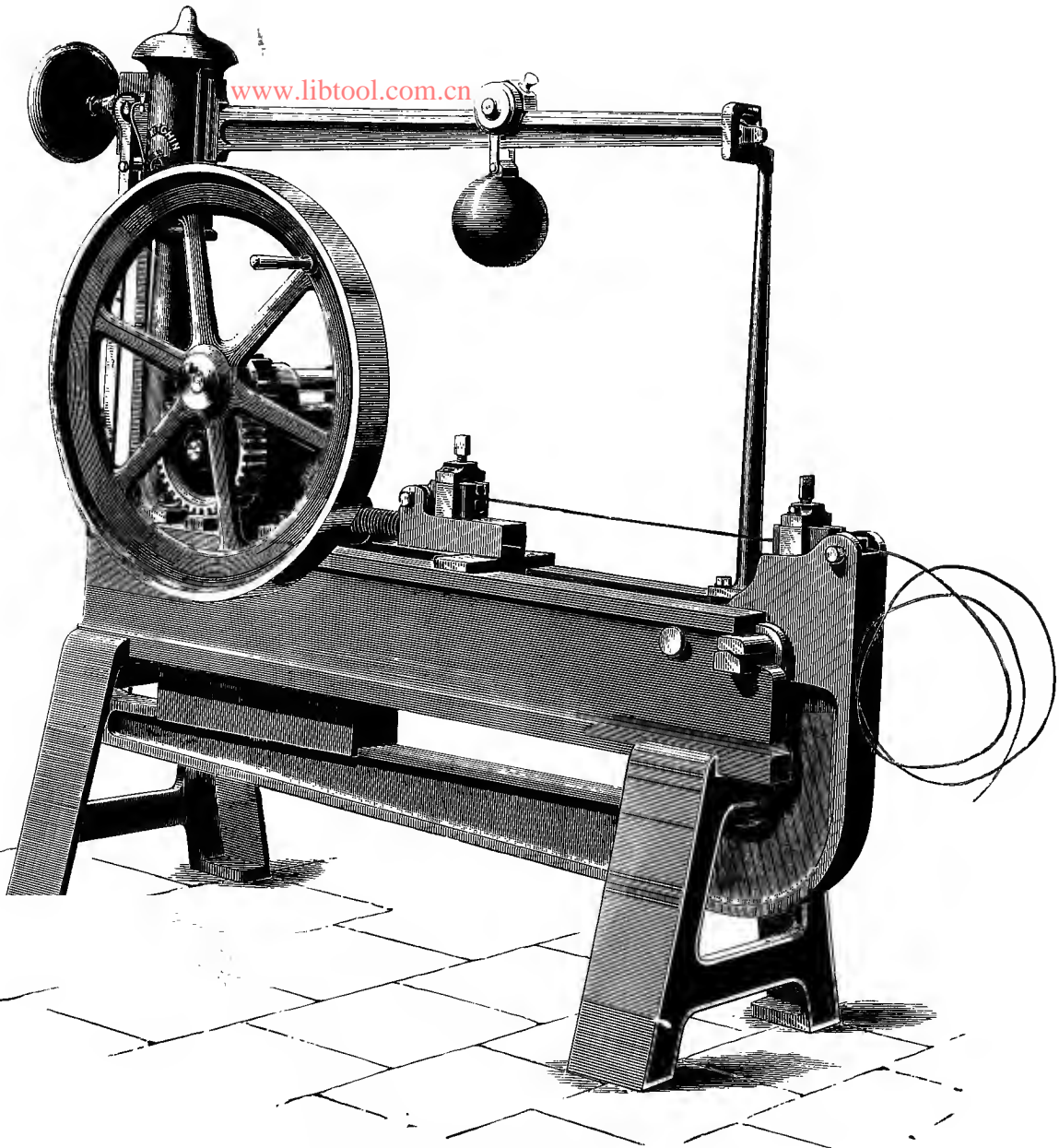

FIG. 19. KITCHIN'S WIRE-TESTING MACHINE.

www.libtool.com.cn

4
2
2
2

drawing. Some sixteen or eighteen years ago, A. Thornton, a comparatively young "card-wire-dresser," unencumbered with old inherent prejudices in the trade, commenced experimenting on the principle at issue, and which shortly afterwards culminated in the production of a continuous wire-drawing machine of the class above referred to.

During Thornton's assiduous labours he was materially assisted by the services rendered him by his two sons, Harry and Edward, and to the achievements of this combination much credit is justly due.

The ultimate result of these praiseworthy experiments was the production of a mill capable of drawing wire from about Nos. 34 to 48 G. at one operation, or a continuous and simultaneous reduction of fourteen sizes. At the Glasgow Exhibition hard copper wire was drawn by this process over 100 miles in one length, the weight of same being about 11 lb., and the time occupied in drawing some forty hours. During this time the machine was run without a single stop. Now it is feasible to reduce wire some nineteen or twenty sizes at one continuous operation, the consecutive processes of drawing being carried on simultaneously. This valuable innovation was followed by Bryne's patent already referred to, and this in its turn has been supplemented by those of Bolton, Roberts, Christie, and others.

Bolton's system of continuous wiredrawing we shall have occasion to describe in a later chapter of this treatise.

Reverting to Bryne's apparatus illustrated in side elevation and plan respectively (Figs. 20 and 21), the pulleys *b*, carried by the framing *a*, are driven by suitable gearing at the required angular velocity; *c* represents the primary drum upon which the wire to be treated is placed, and *d* a similar drum upon which the reduced wire is finally wound after the process of continuous attenuation; *e* are brackets on the machine which carry the rotary dies *E* through

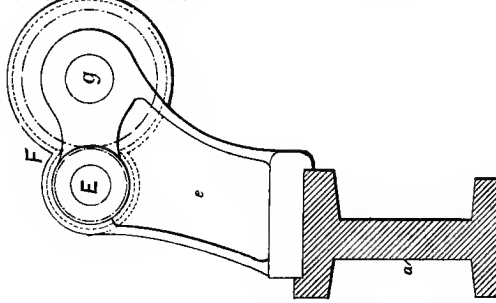

FIG. 22.

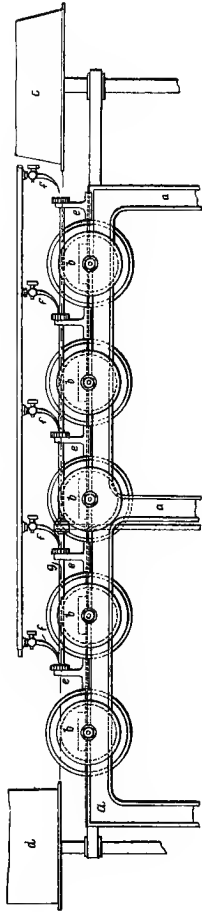

FIG. 20.

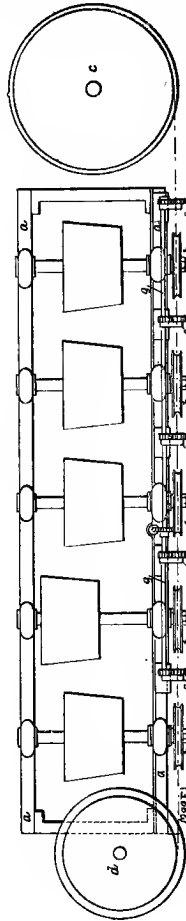

FIG. 21.

which the wire is drawn, the requisite motion being imparted to the same by spur gearing F, more clearly shown in the detached view to an enlarged scale given at Fig. 22 of the drawings.

The drawing discs or dies are formed of perforated balas pea-port, or other like mineral substances, held within annular metallic frames provided with peripheral teeth as indicated and already described. These frames are rotated by the pinion gearing shown upon the spindle *g*. The wire is drawn through the series of dies E (on *e*) from one end of the machine to the other by means of the pulleys *b* and drum *d*, and by which it is continuously reduced in sectional area. The peripheral speeds of the various pulleys have to be carefully adjusted in accordance with the amount of elongation resulting in the wire as it passes from one die to the next; *f* represent lubricating tubes provided with suitable stop-cocks, so as to cause at pleasure a stream of liquid, such as a solution of soft soap, to impinge upon the perforations of the drawing dies. In practice the pulleys are also kept half immersed in the same liquid lubricant.

The arrangement of rotary drawing dies of perforated mineral substances above described with reference to Bryne's invention is particularly ingenious, and it is to be regretted that through some lack of British enterprise, or fear of labour troubles, the patent rights were sold to a leading Continental firm.

In the succeeding chapter, which treats upon fine wiredrawing of the more precious metals, we shall refer to other similar processes of continuous manipulation.

Fig. 23 illustrates Messrs. Wood & Smith's machine for straightening rods and wire. Wire proper is usually sold in hanks or coils, but rods are frequently required in straight lengths. This machine incorporates three distinct functions, viz., that of straightening, propelling, and cutting of the wire into suitable lengths. The mechanism for

www.libtool.com.cn

obtaining the first result will be better understood by reference to the detached view, Fig. 24, in which B, C, and D, represent the straightening heads or devices capable of

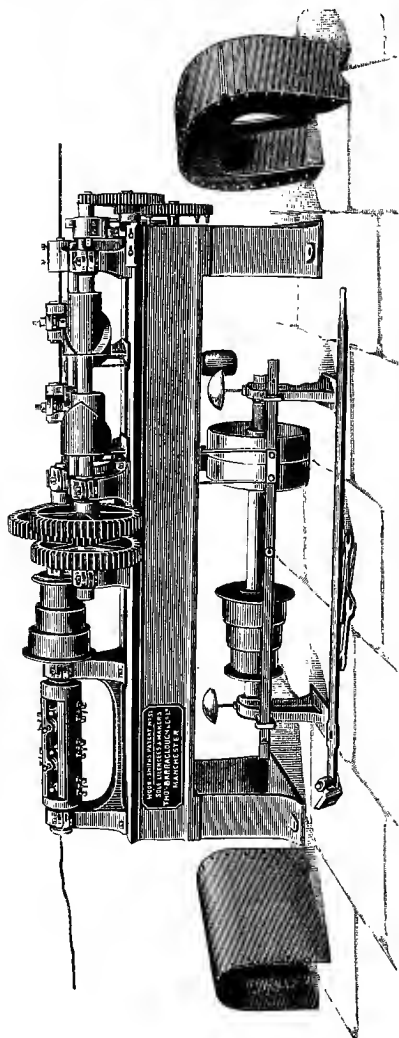

FIG. 23.

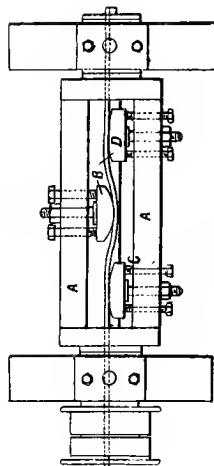

FIG. 24.

adjustment within the framing A. As this portion of the machine is revolved at a high speed, these "heads" or

dies bend the rod or wire in reverse directions so as to effectually remove all "kinks" or irregularities. The mechanism for propelling the wire through the machine consists in an arrangement of cams, which imparts an angular reciprocating motion to levers, provided with clipping jaws, which thus seize the wire and carry it forward. The cutting contrivance is shown at the opposite end of the machine and comprises an upper fixed and a lower movable jaw, both of which are provided with suitable cutters or blades, controlled by a stud actuated by spur-gearing. By the use of interchangeable studs and gearing the mechanism can be timed to cut the rods or wire into any required lengths. The machine is driven from a pulley situated beneath the framing as shown in Fig. 23 of the illustrations.

Before closing the current chapter, brief reference may be appropriately made to some of the arrangements and capabilities of a few leading iron and steel wire manufacturers' works in this and other countries.

The factories of Messrs. R. Johnson & Nephew, at Manchester and Ambergate, are amongst the oldest and most extensive to be found in this country. This firm was founded between 1780 and 1790 by the great grandfather of the present junior partner, and at the present time the two works above mentioned find employment for about 1000 hands. The chief specialities manufactured by this well-known firm are notably telegraph, fencing, rope, and tinned mattress wire, &c. They are also large producers of "barbed fencing" wire, which will be duly described in the chapter devoted to fencing materials and equipments. Messrs. Johnson & Nephew roll their rods on a semi-continuous system, and conduct their galvanising operations upon a continuous method similar to that previously described with reference to Bedson's inventions. A ground plan of the eligible works owned by the eminent

- A. -- Workmen's Houses.
- B. -- Netting Works (3 Stories).
- C. -- Wire Rope Works (3 Stories).
- D. -- Netting Galvanising Works.
- E. -- Netting Warehouse.
- F. -- Barb Wire Galvanising Works.
- G. -- Barb Wire Factory.
- H. -- Mechanics Shop.
- I. -- Annealing Shop.
- K. -- Fencing Wire Warehouse and Varnishing Works.
- L. -- Warehouse (3 Stories).
- M. -- Residence.
- N. -- Warehouse (3 Stories), Loading Below.
- O. -- Steel Wire Drawing Mill (2 Stories), Staple Work above.
- P. -- Joiners' Shop.
- Q. -- Tinning Shop (No. 1).

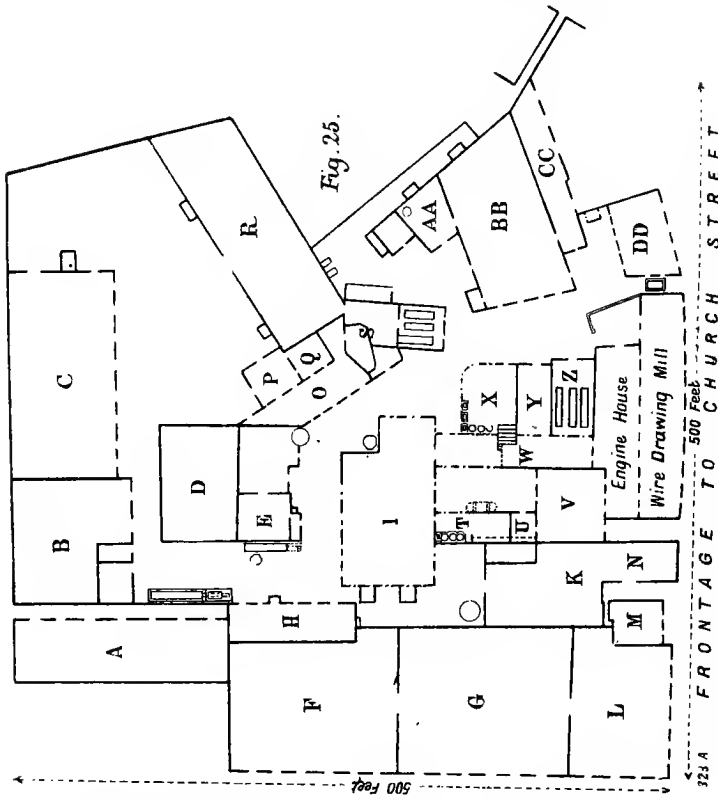

- R. -- Steel Works.
- S. -- Fine Wire Mill (2 Stories), Boilers below.
- T. -- Cleaning Yard (No. 2).
- U. -- Tinning Shop (No. 2).
- V. -- Wire Drawing Mill, Warehouse above (3 Stories).
- W. -- Yard and Warehouse below, Wire Drawing Mill above (3 Stories).
- X. -- Covered Cleaning Yard (No. 1).
- Y. -- Pointing Shop.
- Z. -- Boiler House.
- AA. -- Smelting Shop.
- BB. -- Galvanising Works.
- CC. -- Warehouse and Testing Rooms (2 Stories).
- DD. -- Offices, Springmaking above (3 Stories).

MESSERS. RYLANDS BROTHERS WORKS.

firm of Messrs. Rylands Brothers, Limited, of Warrington, is represented by the accompanying diagram, Fig. 25, and to which descriptive notes relating to the various departments are attached.

The inauguration of this well-known firm dates from 1805, whilst at present its combined weekly production of wire and products amounts to about 700 or 800 tons, the number of hands employed being some six to seven hundred. Messrs. Rylands Brothers manufacture iron and steel wire for most purposes in the trade, *e.g.*, such as employed for telegraph, fencing, and rope making or other like purposes, besides galvanised, tinned, and coppered wire for a variety of applications. The company are further large producers of wire roping and netting, &c.

The Whitecross Company, Limited, established in Warrington in 1864, certainly incorporate one of the most extensive and important industries to be found amongst the leading wire manufacturers of the world. The works of this company stand upon upwards of thirteen acres, whilst some 800 to 1000 hands find daily employment in the various departments of this enterprise. Some forty boilers and fifty engines, generating about 4000 I.H.P., are utilised on these premises for furnishing the requisite power absorbed in their daily manufactures. The premises are in direct communication with the North-Western, Midland, Great Northern, and other railway systems, besides being accessible to Liverpool by water *via* the Mersey, which route, however, will be advantageously superseded upon the opening of the Manchester Ship Canal. The Whitecross Company's operations extend from the manufacture of puddled bars, iron and steel billets, to the rolling of rods and production of all descriptions of plain and coated wires. The company's forges and mills are capable of supplying sufficient material for all their own requirements, the later producing about 35,000 tons of

www.libtool.com.cn
finished rods per annum, with "tempers" ranging from 1.0 to 0.1 per cent. of carbon. The wire-drawing mills are laid out or arranged so as to be capable of working from a rod half an inch in diameter down to wire of No. 40 S.W.G. A number of large baths are provided for galvanising purposes, and through which various wires are conducted, after cleansing, on a continuous system already described. The general arrangement, and extent of the forges, rolling, and wire mills, annealing, tempering, patenting and galvanising shops, ropery, netting, and nail-making departments, &c., constitute typical examples amongst British manufacturers.

Amongst the leading manufactures or specialities produced by the Whitecross Company may be cited iron and steel telegraph and telephone wire according to the requirements of Government and other specifications; plain and galvanised fencing wire, various qualities of rope wire, tinned and copper wires, &c., for various purposes. The rope department has a capacity of over 5000 tons per annum, and where all descriptions of roping are constantly being manufactured.

The netting shop contains efficient machinery capable of turning out about 5000 miles per annum of various strengths and meshes ranging from a quarter of an inch to four inches.

The nail factory is provided with some of the most recent types of machines, equal to a yearly output of 1500 tons.

A well-appointed chemical laboratory and mechanical testing department are provided upon the premises, and through which all raw materials and finished products have to pass before being used or sent into the market. Mechanics' shops, equipped with necessary tools and machinery, are also provided for doing all the company's necessary repairs.

Railway communication is provided throughout the

various departments of the works, the company keeping two locomotives always under steam for the purpose of transporting materials or products. A pumping station and reservoirs are arranged near the wharf for supplying the entire works with necessary water, and which amounts to a consumption of something like 5,000,000 gallons per annum. The company's collieries, situated at St. Helen's, produce about 1000 tons of coal per day, a portion of which furnishes the fuel for the various operations of the Whitecross factories. From that which has been explained it will be appreciated that these important works are practically self-contained and supporting, that is to say, they furnish most of their own raw materials used in their various manufactures, and manipulate the same upon the their premises into the various products required in the wire trade.

It has been stated in the introductory chapter that Mr. Monk founded the above industry, and which may now be supplemented by the explanation that this gentleman was the original manager, whilst Mr. R. Murray was the organiser and financial principal.

Amongst the most important Continental works manufacturing iron and steel wire and such products, those of the Eisen-Industrie zu Menden and Schwerte and the Westfälische Union may be cited as typical examples. The first-named company was established in 1836, and at present turns out about 70,000 tons of combined productions comprising puddled and rolled bars, wire rods, drawn wire and nails, &c., of various descriptions.

The Westfälische Union was founded in 1873, and consists of an incorporation or amalgamation of several old-established works in the Westphalian district, the headquarters being situated at Hamm. The combined output of this corporation is about 100,000 tons per annum, and which gives employment for some 3300 hands, the chief

www.libtool.com.cn

products manufactured being wire rods, drawn wire of almost every kind whether plain, galvanised, coppered or tinned, wire strands and roping, wire nails, rivets, and screws, besides large quantities of bar iron, axles, and sheet metal, &c.

The Trenton Iron Company, New Jersey, are amongst the big producers of iron and steel wires in the United States of America.

At the close of the following chapter reference will be made to other large works in the United States of America and on the continent of Europe which manufacture copper and other wires beyond those composed of iron and steel.

CHAPTER II.

COPPER, BRONZE, BRASS, ALUMINIUM, AND SILVER, &c., WIRES.

As the previous chapter somewhat exhaustively describes the various processes and plant employed in the manufacture of iron and steel wire, which are very similar in many respects to those used for the production of wire composed of other metals, it will be now desirable to avoid repetition as far as possible.

After iron and steel wire, that formed of copper occupies the next place, alike for usefulness or amount of consumption, although its applications are practically confined to electrical purposes, such as for the manufacture of submarine electric telegraphs, electric lighting and telephone cables, dynamo machines, or the construction of armatures and field magnets for electric generators and motors, &c.

Copper probably derived its name from Cyprus, the island from which the Romans procured their supply. The metal was first termed "Cyprium," and which afterwards degenerated into the corruption "cuprum." Probably copper was the first of the metals discovered and worked, owing to the physical character of its ores and the facility with which it is fused. Wire and various articles were manufactured from copper or bronze by the ancient Egyptians. The metal is usually found in combination with others, such as tin, iron, nickel, and cobalt, &c. The ores from which copper is extracted comprise a large class of minerals, *e.g.*, native, red, grey, black, purple, glance

pyrites, &c., or in the forms of metallic copper, sub-oxide, sulphide of copper, lead and antimony, protoxide, sulphide of copper, and iron, &c. Cornwall and Swansea are the chief seats of the copper mining and smelting, &c., industries of this country, but large quantities of ingot and tile copper obtained from foreign countries are annually sold in the London and other markets. Japanese and U.S.A. copper is in great request for the manufacture of wire for electrical purposes. A metallic purity or conductivity of from 96 to 98 per cent. is usually required by manufacturers and consumers of copper wire for electrical applications, but this and other like considerations will be discussed in a separate chapter of this treatise.

Pure metallic copper is of a red colour and is capable of receiving a high polish; it is very malleable, ductile, and tenacious, its last-mentioned property ranking only second to that of iron. The average specific gravity of copper in the form of wire is about 8.93 to 8.95. The metal in a heated state readily absorbs oxygen, but when cold it does not materially oxidise like iron or steel; the tarnish found upon copper is attributable to moisture in the atmosphere; dry air has no effect upon the metal. Copper is an excellent conductor of heat and electricity. The metal is, however, very soft, and in the form of wire its comparatively low tensile resistance causes a tendency to excessive permanent elongation, for which reason, independently of its high intrinsic value, iron or steel telegraph wire is usually adopted. Later on we shall have occasion to refer to a form of copper wire termed "hard drawn," which possesses a much greater strength, *e.g.*, to 30 tons per square inch.

The extraction of copper from its various ores involves some of the most complex processes in the science of metallurgy, and therefore it is impossible to discuss the subject within the available limits of this volume. It may, however, assist the reader to know that the processes may be

usually generalised under "roasting" and "melting." The former is resorted to for the purposes of expelling arsenic and sulphur, and for converting metallic iron into the oxide, whilst the latter process removes the oxide of iron, and leaves the copper in the form of a sulphide. For treating some ores the two methods mentioned are combined in one process in order to eliminate the sulphur and obtain metallic copper. The metal thus obtained may be afterwards refined by heating it within a reverberatory blast furnace lined with clay and powdered charcoal. The presence of any foreign matters reduces the electrical conductivity of copper to a marked extent. The conductivity of some copper is little inferior to that of silver, and may attain an efficiency within some few per cent. of the latter metal. Copper extracted from ores obtained from Lake Superior, some Chilian, Australian, and Japanese mines, is of the best quality for the manufacture of electrical wires.

The best refined copper is practically pure, *i.e.*, when foreign substances present do not exceed .1 per cent. Ingots or billets of copper are reduced to rods by rolling in the hot state in a similar manner to that already described with reference to the manufacture of iron and steel wire. Some years ago it was the custom to obtain copper and brass wire by rolling out long strips, which were afterwards cut into shreds for the wire-drawing mill; indeed, some factories still retain this old practice. The rods or shreds are then drawn through perforated steel plates or gems—the former for large and the latter for fine sizes—in the cold state to produce wire, as described in the preceding chapter. At certain intermediate stages the wire has to be usually annealed or softened in the manner also before explained, or it may be "drawn and finished hard" for some particular requirements. This process of induration is obtained by mechanical manipulation or treatment, as copper is not affected by heating and suddenly cooling, like steel.

There is no practical difference between the copper wire used for telegraphic and electric lighting, &c., purposes, although the sectional area of the metal and extent of insulation employed has to be varied. In cases, however, where bare copper wire is required to be supported in overhead positions, greater attention is paid to tensile strength than maximum degrees of conductivity.

The copper used for "hard-drawn" wire is specially selected and treated in the refinery so that it will submit to mechanical induration without becoming brittle. This process of hardening reduces the electrical conductivity of the metal some 2 to 4 per cent., according to the extent to which it is carried out. Hard drawn copper wire is now extensively used for overhead telephone and electric traction, &c., conductors. Sometimes strands of three or more wires are used instead of single conductors.

The larger sizes of copper wire are drawn separately through plates, whereas finer gauges are now commonly produced by methods of continuous drawing, as already referred to in the preceding chapter.

Figs. 26 and 27 illustrate Alfred and Thomas Bolton's continuous wire-drawing mill as patented in June, 1887, and the names of these inventors will be recognised by many readers as those incorporated in the eminent firm of Messrs. Thomas Bolton & Sons, of the Oakamoor Copper and Brass Mills, Staffordshire. This well-known firm has works also at Widnes and Birmingham.

According to Bolton's system of continuous drawing a wire may be reduced to, say, $\frac{1}{15}$ th its original diameter at one operation, or as fine as a human hair.

Fine copper wires are now largely used for forming the flexible cords or conductors of incandescent lamps and other like electrical appliances.

From that which has been previously written and illustrated concerning continuous wiredrawing, a brief descrip-

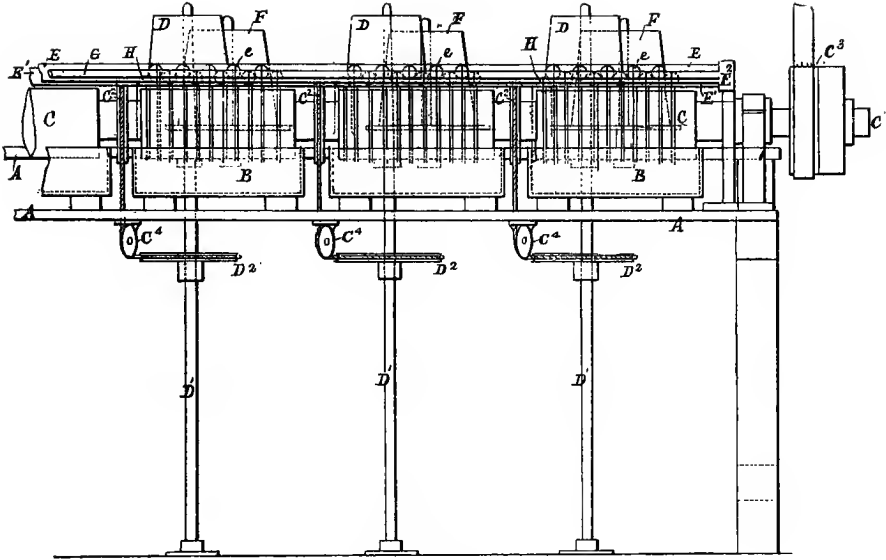

FIG. 26.

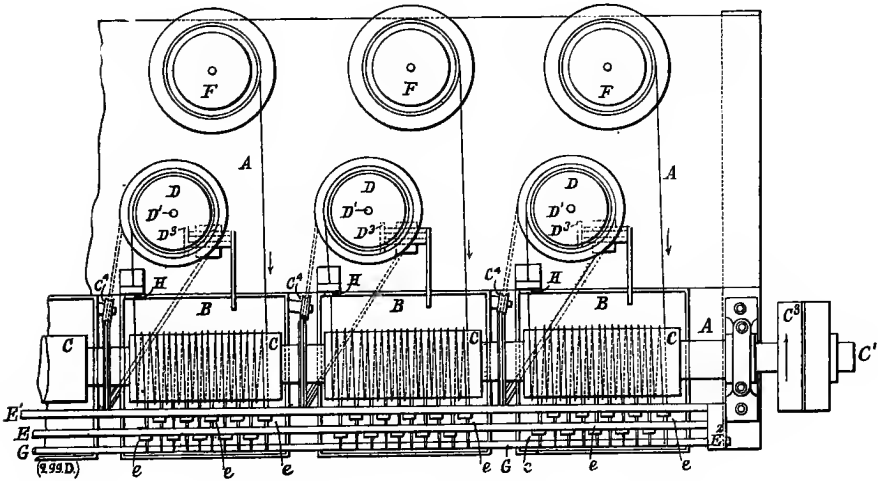

FIG. 27. BOLTON'S CONTINUOUS WIRE MILL.

tion will suffice to explain the system at issue. Fig. 26 represents a front elevation and Fig. 27 a plan of Bolton's apparatus under consideration. A is a bench to which a series of lubricating troughs B are fixed for receiving the underside of the cylinders C, formed upon the horizontal shaft C¹, mounted in suitable bearings attached to the bench. E E' are two parallel bars for carrying the drawing dies *e*, supported by the standards E². Ten dies are shown in the illustration as a suitable number for drawing copper or brass wire, but it will be understood that the number in each group could be varied according to requirements or the metal to be treated. The reels F, mounted on vertical spindles, serve to carry the wire to be drawn or in intermediate stages of attenuation. G is a bar arranged in front of the dies for directing and controlling the course of the wire under treatment. Wire taken from the reels F is passed around the driving cylinders C, partially immersed in lubricating liquid contained in the chambers B, and then taken to the guiding bar G, around which it is lapped so as to bring it opposite the first drawing die *e*. Upon examining the drawing it will be readily apparent how the wire is continuously drawn through the series of dies by the cylinders C, so as to simultaneously cause a uniform increasing reduction in the thickness of the wire. After the wire has been pulled through the dies on the bar E, it is returned to the cylinders by those on E', and in like manner it is conducted from one group of dies to the next throughout the consecutive progressive stages, until the wire is drawn through the finishing dies H, fixed on independent supports opposite to the draw-off drums D. The machine is driven by means of a pulley C³, fixed upon the shaft C¹. The reels F and D are actuated by bands driven from the cylinders C through the intervention of the pulleys C², C⁴, and D². For the purpose of throwing the drums D out of action when desired, eccentric motions, D³, are provided

upon the bench and by which the drums can be raised clear of frictional contact with their conical spindles D' . As the cylinders C are here all of the same diameter and driven at one speed, obviously any necessary compensation for the elongation of the wire must be obtained by slipping. Fig. 28 illustrates Bolton's invention as applied to the operation of an ordinary draw-bench, similar letters of reference being used to those attached to corresponding parts in the previous figures just described.

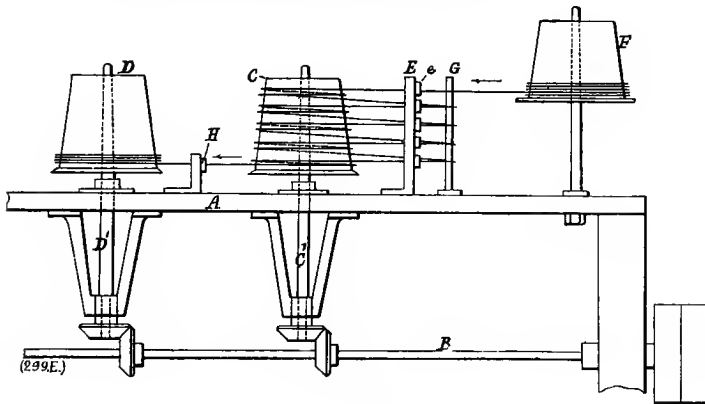

FIG. 28.

In 1872 C. A. Dick, of Pittsburgh, U.S.A., obtained a British patent for the manufacture of "phosphor bronze," or an alloy composed of copper, tin, and phosphorus, and which was claimed to form a valuable substitute for copper required for electrical and other purposes, inasmuch as it possessed greater tensile strength and was inoxidisable. The alloy contained from 2 to 6 per cent. of tin, and from $\frac{1}{20}$ to $\frac{1}{8}$ per cent. of phosphorus, but it was soon discovered that although greater strength and elasticity were thus obtained, the presence of the last-named element was detrimental to efficient electric conductivity. Sometimes the employment and term of "phosphor bronze" are still somewhat indiscriminately applied, but it may be accepted as a

www.littool.com.cn
matter of fact that any wires presenting a conductivity of over 35 per cent. are not composed of this alloy, whatever they may be termed.

In 1882 L. Weiller, of Paris, obtained patents for the production of an alloy termed "silicium-bronze," formed by adding silicium and sodium to copper in a particular manner as the broad principle was previously known. His invention practically consisted in the introduction of substances into molten copper or bronze, which by chemical reaction furnished silicium and sodium. For this purpose he placed within a plumbago crucible fluo-silicate of potash pounded glass, chloride of sodium and calcium, carbonate of soda and lime, and applied heat. After reaction had taken place the contents of the crucible was thrown into the molten metal to be treated, and the application of heat continued. Finally the alloy was cast into ingots, rolled into rods and drawn down to wire in the usual manner. The properties of silicium-bronze wire were then found to be that it presented a conductivity of some 40 per cent. within that of copper, and four times more than iron, although only about one-fourth the weight, whilst its tensile strength was nearly that of steel. Mons. Weiller soon realised the importance of his invention for furnishing superior telegraphic and telephonic conductors.

According to a modification, the patentee described the use of a metallic base of soda combined with tin or tin and copper to form silicium-bronze, or combinations with silicium in the presence of fluo-silicate of potash when introduced into melted copper or bronze.

The conductivity of the alloy now ranges from 40 to 98 per cent. within that of copper, and the tensile strength from 29 to 55 tons per square inch of section.

During 1888 Weiller supplemented his invention by patents for improving the density and tenacity of his alloy, and which consisted in adding zinc to copper, bronze, or

alloys of silicium and sodium. The practical success of Weiller's discoveries are now not only long since proved, but generally accepted, and by way of exemplification extracts from the paper on "Electrical Conductors," read by Mr. W. H. Preece, F.R.S., before the Institution of Civil Engineers, are here appended.*

"Phosphorus has a most injurious influence on the electrical resistance of an alloy. Silicium is far superior; hence the silicious bronze is preferable for telegraphic purposes. Its efficiency is very great; in fact, phosphor-bronze has disappeared for telegraph wire, and has been replaced by silicious-bronze.

"The electric resistance of silicious-bronze can be made nearly equal to that of copper, but its mechanical strength diminishes as its conductivity increases. Wire whose resistance equals 95 per cent. of pure copper gives a tensile strength of 28 tons on the square inch, but when its conductivity is 34 per cent. of pure copper its strength is 50 tons on the square inch. Its lightness, combined with its mechanical strength, its high conductivity, and its indestructibility, rendered it eminently adapted for telegraphs.

"Long telegraph lines, for which iron wire weighing 400 lb. per mile is now used, can be made of bronze wire weighing 100 lb. per mile, which would give higher electrical efficiency; and over-house lines, for which steel wire is often used, can be replaced efficiently by bronze wire, weighing only 30 lb. per mile, which would be almost invisible.

"If overhead wires were erected of such a material, upon slightly supports, and with some method, there would be an end to the meaningless crusade made in some quarters against aerial lines. These, if constructed judiciously and under proper control, are far more efficient than underground lines. Corporation and local authorities should

* Vol, lxxv, of the Proceedings.

control the erection rather than force administrations to needless expense and to reduce efficiency by putting them underground. Not only do light wires hold less snow and less wind, but they produce less electrical disturbance, they can be rendered noiseless, and they allow existing supports to carry a much greater number of wires. Other bronzes have been tried, but without any evident advantage, either in quality or price."

These quotations serve to concisely convey the cardinal virtues of silicium-bronze wire as recognised by an incontestible authority. As a supplement to the advantages already defined, the following particulars may not be superfluous. The alloy is inoxidisable; its intrinsic value as a remelted metal is equal to that of the best qualities of copper. There are single poles now in this country which are supporting over 200 silicium-bronze telephone wires, an achievement utterly impossible where iron or even hard-drawn copper wires are employed. For telegraph services a wire .080 in. in diameter, weighing 100 lb. per mile, can be used in lieu of iron wire 0.2 in. in diameter, weighing about 630 lb. per mile. Some qualities of silicium-bronze wire now possess a conductive efficiency up to within 97 per cent. of pure copper, with a tensile resistance of nearly 30 tons per square inch of sectional area. For railway telegraphic purposes, or long distance wires, an alloy presenting 80 per cent. of conductivity and 35 tons strength is recommended. For telephone lines, wires of 50 tons strength and a relative conductivity of about 45 per cent. that of copper, is largely used and advocated. Mons. L. Weiller's British and Colonial patents are the sole property of the Phosphor-Bronze Company, Limited, of London, whose manufactures are so well known and appreciated that further comment is unnecessary. This company also manufactures rolled brass, German silver, copper, dipping and gilding, &c., metals.

In the chapter upon electrical conductors, a Table of the weights and electrical resistances of silicium-bronze wires is incorporated.

Brass wire is commonly composed of an alloy formed of $1\frac{3}{4}$ to 2 parts of copper to 1 of zinc, the ingots being rolled into rods in a cold state, in order to obtain strength and toughness, and these are afterwards drawn into suitable sized wires, similarly to copper and other metals before described. During drawing it requires, however, to be more frequently annealed than copper wire.

An enormous quantity of brass wire is annually consumed in the manufacture of pins, rivets, &c.

The tensile strength of this material may range from about 20 to 40 tons per square inch of sectional area, dependent upon the amount of zinc used in the alloy, whereas ordinary drawn and annealed copper wire may range from, say, 15 to 20 tons. Brass wire may be drawn at a speed of from, say, 200 ft. to 350 ft. per minute, and copper wire from about 250 ft. to 750 ft. per minute, dependent upon the diameters of the wires.

“Delta” wire is made from an alloy composed of copper, iron, and zinc, which forms a very strong and tough material. Some of this wire has a breaking equivalent of over 60 tons per square inch of section, but in about 45 to 50 ton quality it possesses considerable toughness and pliability, and has withstood from thirty-five to forty twists in 8 in. lengths. Some soft delta metal wire is used for the manufacture of special kinds of roping, whilst finer sizes are employed in the production of certain classes of gauze and braiding, &c. The alloy is not subject to oxidation nor deposits of verdigris. Professor Unwin, F.R.S., M.I.C.E., in a somewhat recent lecture referred to the properties of this alloy as follows :—

In alluding to the tensile strength of delta wire, which was stated to be 62 tons per square inch, he said it was quite true that steel wire often possessed greater

tensile strength, in some cases even as much as 150 or 180 tons per square inch, but such wire was brittle. The property of delta metal, upon which he would lay special stress, was its toughness, which, combined with its tensile strength and resistance to corrosion, render the alloy exceedingly valuable for many manufactures.

Aluminium in the form of wire has a specific gravity of about 2.68, but as its tensile strength is only some 10 tons per square inch of cross-section, and its elastic limit equally low, it cannot be regarded as a useful metal for structural purposes. Fine aluminium wire is sometimes used for philosophical instruments, where great lightness is required and for metallic embroideries or lace, in the place of silver. When, however, the metal is alloyed with copper, a material can be produced—known as “aluminium-bronze”—of high tensile and elastic efficiency. The physical properties of the metal in question are very characteristic, *e.g.*, it is malleable, ductile, sonorous, an excellent conductor of heat and electricity, is inoxidisable and unaffected by the presence of sulphur.

Aluminium wire has been drawn as fine as 11,400 yards to the ounce, or at the rate of about .042 grains per yard, a size too fine to be practically measured by any gauge or instrument. Obviously such degrees of fineness are more for exhibition purposes than practical use. Aluminium is probably the most abundant and widely diffused of all metals, although it is never found in nature in a free state, but in combination with every variety of clay in quantities varying from some 10 to 20 per cent. This metal was first extracted by Wöhler in 1828.

“German or nickel silver” is an alloy of copper, zinc, and nickel, or practically brass whitened by the addition of nickel. This alloy has been drawn into wire as fine as .002 in. in diameter, in which form it is sometimes used for electrical and other scientific instruments.

Whilst mentioning practical examples of fine-drawn

wires, it may be stated that iron has been thus attenuated, so that over $2\frac{1}{2}$ miles in length only weighed one ounce, and frequently this metal has been drawn into wire of .003 to .002 in. in diameter, although very fine sizes in so highly an oxidisable metal is not usual or desirable. Amongst the finest practical gauges of iron or steel wire are those used for carding brushes or belts.

Platinum is a very valuable metal, found usually in a free state in alluvial deposits where gold is present. The metal was first discovered in Jamaica in 1741, its name being derived from the Spanish, signifying "little silver." The chief sources of supply are the Ural Mountains, Peru, and parts of Australia and California. Although platinum, like gold, occurs in the metallic state, it is usually found associated with iron and copper or the rarer metals, iridium, rhodium, palladium, and osmium. The metal follows gold and silver for ductile efficiency, and therefore can be readily drawn into the finest sizes of wire, although its high intrinsic value is greatly against its extensive application. The uses of platinum wire are therefore practically confined to special scientific instruments and electrical appliances in which resistances to high temperatures, oxygen, and acids, are essential. Wire formed of this beautiful metal also finds indispensable employment in blow pipe operations and experiments. Besides its high fusing point, platinum expands less than other metals when heated, and which property therefore permits it being sealed in glass without fear of cracking. The practical value of this unique property makes it extremely useful in the manufacture of incandescent lamps, and various other philosophical purposes. By the courtesy of the eminent firm of Messrs. Johnson & Mathey, the writer has had facilities of inspecting the manufacture of platinum wire from .001 in. in diameter, and upwards, and further wires of platinum and silver alloys from .0008 in. in diameter, although that of

about .0015 in. would be considered more a commercial production.

Silver is usually extracted from its ores by the process of cupellation, eliquation, or amalgamation, the principal sources of supply being from mines situated in the United States, Mexico, Peru, Chili, Bolivia, Australia, Spain, and Hungary. Silver is the best conductor of heat and electricity amongst the metals, and which properties decrease as the temperature rises. Its specific gravity ranges from about 10.5 to 10.6 although in its pure state it is usually too soft for practical applications and is therefore hardened by alloying with copper. The standard silver used for coinage in this country contains about 7 per cent. of copper, and in commercial parlance its degree of purity is generally expressed in so many pennyweights above or below the standard value. At normal temperatures silver is not affected by exposure to moist or dry air, but the presence of any sulphur will cause it to tarnish, from the formation of a film of sulphide of silver.

In the wire trade this metal is chiefly used for filigree, embroidery, and decorative work, as well as some scientific instruments. In the former applications it is usually employed in the form of silver-gilt wires, some of which have been drawn as fine as 5000 yards to the ounce, but usually it is not drawn finer than .002 in. to .003 in. in diameter, the latter being about the size of a human hair.

By the courtesy of the old-established firms of Messrs. H. & E. Watts and J. B. Corney, of London, the writer has recently had the opportunity of inspecting some beautiful manufactures in this branch of the wire industry.

The first-named firm has drawn some precious metals and alloys into wire so fine that as much as 6500 yards only weighed 1 oz., and no practical method was available for measuring its diameter. Further, they have drawn

24 grains of gold, on a silver rod, out to 140 miles in length, a result which admirably conveys the degrees of ductility characteristic of gold, silver, and platinum, and the property of divisibility in certain metals.

The silver used in this trade is sometimes about 16 dwt. above standard purity, *e.g.*, 992 per 1000 parts, but for many purposes it is used at standard value or even slightly below same.

Hatton Garden and Little Britain are now the chief districts in London where the fine wire drawers of precious metals carry on their delicate industry. As described in the introduction of this treatise, fine silver-gilt wires are largely made and used for the manufacture of twists, purls, and bullion trimmings, laces, filligrees, embroideries, and other decorative devices for ministerial and ecclesiastical robes, and the uniforms of naval and military officers, &c.

Solid drawn gold wire is now practically unknown in the trade, and the economy of the present practice at issue should be appreciated from the previously cited example of some 24 grains of gold being attenuated so as to cover 140 miles of silver wire. Usually, however, silver-gilt wire of 1500 to 2500 yards to the ounce is fine enough for most commercial requirements. The quantity of gold put upon the rods to be drawn into wire naturally varies according to the quality to be produced, but it may be taken on an average to range from $1\frac{1}{2}$ to 2 per cent. of the weight of silver to be manipulated. The gold is put on to the silver rods in the form of best leaves, about $4\frac{1}{2}$ in. square, weighing some 18 grains per leaf, and the two metals are then drawn down together, first through steel dies, and afterwards through drilled rubies, sapphires, or diamonds, which constitute expensive items in the trade. The French still retain a high reputation for the manufacture of these "gem draw-plates." In the first place the silver ingots, weighing some 1000 oz., are refined or "grained" by melt-

ing and pouring into water, and by which it assumes a granular form. These granules are then collected and melted down into bars, which are subsequently forged into rods, about 2 in. in diameter, under a small steam hammer, in order to obtain compactness or molecular homogeneity. The rods are then "straight drawn" in the cold state through metal dies in order to obtain a smooth surface, when the gold leaves are attached by tapping or rubbing and the straight drawing is continued until they are reduced to about $\frac{1}{2}$ in. in diameter. When the gilding is performed the rods are about $1\frac{3}{4}$ in. in diameter by 2 ft. 6 in. long, and weigh some 350 oz. to 400 oz. each. The reduced rods are then drawn upon "blocks" in the usual manner until the wire is fine enough to be treated in the gem-plates before referred to by the assistance of wax, soap, oil, or other suitable lubricants. The fine wire is drawn upon pulleys, about 18 in. in diameter, operated by hand, at a peripheral speed up to about 20 ft. per second. At the requisite intermediate stages the wire is annealed by winding it on to small copper cylinders some 4 in. in diameter, which are then placed for a few minutes within a charcoal fire. During the various stages of attenuation the wire is at first broken up into about 30-oz. hanks or coils of different gauges, and later into reels of finer wire from, say, 15 oz. to 5 oz. each, the latter containing probably a length of fully 7000 yards. From the particulars previously given it will be evident that the aggregate lengths of wire obtained from an original rod may equal from 400 to 500 miles. The method of drilling the gems to such extraordinary degrees of fineness, requisite for the manufacture of this and other similar classes of fine wire, is kept a secret in the trade. The writer has examined some such mineral draw-plates, in which the holes were only discernible by aid of a magnifying glass. After the silver-gilt wire has been drawn to the required sizes it is flattened out by

rolling in a delicate and very accurate machine, also mentioned in the introduction to this volume, so as to present a larger covering surface when spun upon the yellow silken threads, in which form it is usually sold, for working into various decorative embellishments. For the manufacture of the more common kinds of silver and silver-gilt wires the silver is sometimes bored out and internal copper rods inserted into the same, and the two or three metals are thus simultaneously drawn down together. This affords an astonishing example of the ductile efficiency of certain metals when even only mechanically combined. The insertion of aluminium has been similarly tried for the production of silvered wires, but apparently without much success. For theatrical costumes, wires and "spangles" of yellow and other coloured compositions are largely used, but superior kinds of spangles are also manufactured from minute rings of silver-gilt wire, which are each hammered out on an anvil so as to weld the cuts in the wire and form beautifully bright little discs of metal with holes through their centres.

It has been pointed out that wires of very fine sizes are estimated more according to weight of a given length than by any mechanical methods of measurement. However, wires as fine as a human hair, *e.g.*, .003 in. in diameter, and even thinner, can be gauged by delicate instruments termed "micrometers," an example of which is given at Fig. 29 of the illustrations. The diameter of any specimen may be accurately determined upon insertion between the fixed head-piece and the fine adjustable screw-spindle (at A), when the latter is screwed up to the wire and the measurement read off in decimal fractions of an inch by the Vernier and scale provided upon the collar and handle of the instrument shown. The descriptive numbers of the standard wire gauge range from No. 7/0 (.500 in. in diameter) to No. 50 (.0010 in), but for all ordinary practical purposes No. 40 (.0048 in.) is small

www.libtool.com.cn

enough, indeed, upon reference to Fig. 12, No. 36 (.0076 in.) can only be diagrammatically conveyed by a fine line.

For the purpose of calculating the comparative breaking strains of fine wires in tons per square inch of sectional

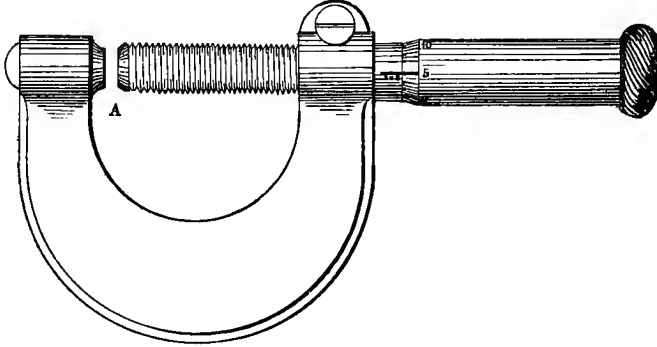

FIG. 29.

area, further revised co-efficients from John Lord's Tables are now appended, the use of which will be self-apparent

No. S. W. G.	Decimal.	Pounds.	No. S. W. G.	Decimal.	Pounds.
20	.036	2.3	25	.019	.635
	.035	2.15	26	.018	.57
	.034	2		.017	.51
	.033	1.91	27	.016	.45
21	.032	1.8		.015	.40
	.031	1.7	28	.014	.346
	.03	1.6	29	.013	.299
	.029	1.48	30	.012	.252
22	.028	1.38	31	.011	.2128
	.027	1.28	32	.01	.1767
	.026	1.19	34	.009	.1425
	.025	1.1	35	.008	.1126
23	.024	1.01	36	.007	.0862
	.023	.93	37	.006	.0633
24	.022	.85	39	.005	.044
	.021	.77	40	.004	.0282
25	.02	.7			

after the description and example given in the previous chapter.

Nos. 33 and 38 are omitted because their differences from the preceding gauges are only in the fourth decimal figures, *i.e.*, .0108 in., .0100 in., and .0068 in., .0060 in.

For most practical purposes the gauge template shown at Fig. 12 will be found sufficient for determining the sizes of all ordinary wires, the use of the micrometer is slower and more complicated, besides in the hands of workmen being liable to errors from unobserved movement. To the eye or by rough measurement, the notches in the template will appear to decrease by uniform and almost imperceptible gradation, but by the use of a micrometer, or upon reference to Lord's Table in Chapter I., it will be seen that between some gauges several thousandths of an inch intervene. Upon reference to Rylands' Table the ratio of attenuation or elongation that wire undergoes by drawing, will be seen to be directly according to the squares of sectional diminution.

The well-known continental firm, Messrs. Felten & Guilleaume, as pointed out in the introductory chapter, commenced their business at Cologne about a century and a half ago under the auspices of Mr. J. T. Felten, whose name has been retained in the style of the firm up to date, although the establishment for the last six decades has been exclusively controlled by the Guilleaume family. The rapid development of their business is unquestionably largely ascribable to the enterprise, energy, and ability of the late F. C. Guilleaume, combined with the natural business aptitudes of the successive heads of the firm. Mr. Theodore Guilleaume is the present sole proprietor.

The migration of the firm to Mülheim-on-the-Rhine is but of comparatively recent date, and the factory that was founded in 1873 has since grown up to an enormous establishment without parallel in the wire trade of the world. These works now cover an area of some eighty acres of ground, which is monopolised by an exten-

sive aggregation of wire mills, galvanising shops, wire roperies, cabling, and barb wire factories, smelting works and mechanical workshops, &c., of every description, supplemented by efficient chemical and mechanical testing laboratories, and a good technical library of standard works. The operative staff, which has been constantly increasing, now comprises 2500 hands, besides a large number of outdoor employés.

A pictorial view representing the Mülheim Works is given on the opposite page.

Some idea of the magnitude of Messrs. Felten & Guilleaume's operations may be gathered from the fact that they are producing upwards of 50,000 tons of wire and wire manufactures, and electric cables per annum.

Every class of wire, from the commonest qualities up to the highest grades, is manufactured by this firm at Mülheim, *e.g.*, for fencing and other agricultural uses, for spring-making, ropes, musical instruments, wool-carding, telegraphic, and other purposes too numerous to mention. Steel, copper, and bronze, &c., wires are drawn on the premises, from the largest to the smallest sizes used in the trade. In the wire rope departments they are similarly employed upon every description of work.

Another prominent feature of this establishment consists in the manufacture of electric conductors and cables of various kinds. The cable factory and its accessories are devoted to the production of every description of telegraph, telephone, and electric light, &c., cables and wires, of all qualities and sizes.

The firm has its own gas and water works and electric light installations on the premises, whilst suitable access to and from the works is obtained by some 2000 yards of full-gauge railway. The requisite motive power is furnished by engines of 2400 nominal horse-power.

Besides the Mülheim establishment, Messrs. Felten &

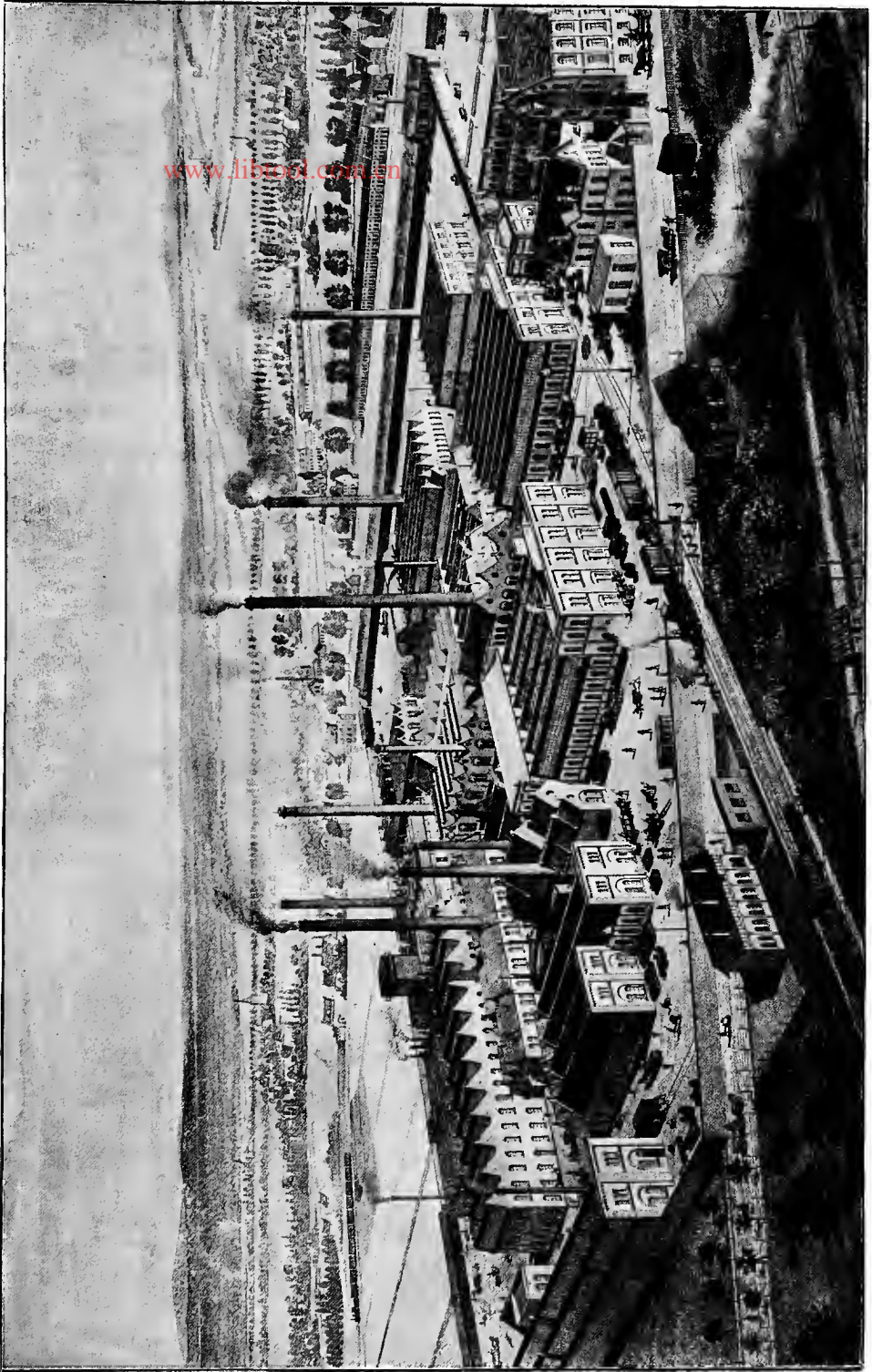

www.libgen.org

MESSRS. FELTEN AND GUILLEAUME'S WORKS AT MÜLHEM-ON-THE-RHINE.

www.libtool.com.cn

Guilleaume are the proprietors of a large spinning mill at Rosenthal, Cologne, for manufacturing hemp-rope, twine, &c. Here the output is about 4000 tons per annum, and which employs 900 hands and 1200 horse-power.

Space does not permit of more than a casual reference to one or two of this firm's achievements, *e.g.*, they were the pioneers of the wire and wire rope industries of the Continent, and now control the largest establishment, not only in Europe, but in the whole world. Upwards of 40,000 tons of finished wire are annually produced at these works. The first telegraph wire for the Prussian Telegraph Department was drawn by this firm. The German underground system of telegraphy was definitely ratified after the success of Messrs. Felten & Guilleaume's cables, laid on the experimental section between Berlin and Halle. It was this eminent firm who supplied and laid the major portion of the telegraph cables which now intersect the German Empire. The telephone cables produced by this firm enjoy a well-merited reputation, especially in hot climates, where some other cables have failed. Their electric light cables are giving satisfaction at the numerous central stations installed by this firm, amongst which may be cited those at Barmen, Hamburg, Bremen, Lubeck, &c.

By no means the least noteworthy feature connected with this firm is the manifest care bestowed upon the comfort of their staff. The numerous workmen's dwellings built by the firm are models of sanitary construction; an infant asylum, a free school, co-operative stores and savings bank, testify to the firm's care for the welfare of their employes and offsprings.

It may also be mentioned that by their very eligible situation on the banks of the Rhine they possess good facilities for shipping, so that the works enjoy every convenience for speedy transport by land or water.

www.libtool.com.cn
In the United States of America there are several important wire rod-rolling, drawing, and rope-manufacturing firms, amongst which, perhaps, that of Messrs. John Roeblings, Sons & Co. will be most familiar. The works of this company were established at Trenton, New Jersey, in the year 1849, and at present occupy an area of some 25 acres of ground. The rope-producing capacity of these extensive works is stated to be equal to 7000 tons per annum. The premises are equipped with suitable appliances for the manufacture of all kinds of wire roping and cables for mechanical and electrical purposes, besides the production of wire netting, nails, and fencing materials, &c.—in which industry some 2000 hands derive daily employment. This American firm has manufactured large quantities of special roping for cable tramway purposes, some of which, it is stated, have attained a running life of over 90,000 miles. Some of these ropes are 7 miles long, in one continuous piece. Ropes manufactured by this company are usually of six strands of seven or nineteen wires, the latter construction being preferred in cases where considerable pliability is required. Here the safe working loads of roping are estimated at from one-fifth to one-seventh of their ultimate breaking strengths, whereas in Great Britain, the average factors of safety vary from one-sixth to one-tenth of their ultimate resistances and as will be discussed in a later chapter.

Messrs. Roeblings manufacture various classes of steel wire cables up to a tensile efficiency of from 200,000 lb. to 300,000 lb. per square inch of sectional area, say, to 130 tons. This firm has supplied cables for numerous important suspension bridges built in America, *e.g.*, those used in the construction of the Niagara Falls, Cincinnati, Pittsburg, and New York and Brooklyn Bridges, &c.

Our transatlantic cousins are in some respects to be congratulated upon their system of co-operation and protection in

order to maintain more profitable prices for manufactures; in this country the wire and rope trades are at present severely mutilated by cutting competition.

Messrs. Roelblings also produce large quantities of iron, steel, and copper telegraphic and telephonic wires, possessing high conductive and other physical properties. The Belgian system of rolling long lengths of wire rods and improved methods of galvanising wire were first introduced into the United States at these works.

The efficient arrangement of the continuous rod-rolling machinery provided at these important works has already been described in the preceding chapter. Here the annealing furnaces are mainly heated by petroleum gas, a system both clean and effective. The wire cleansing and liming department is also admirably arranged, with the view of economising labour. These stages of treatment are carried on in circular vats accessible to hydraulic cranes, and which take the hanks of wire from the washing solutions to the limewater tanks with ease and despatch. Some 30,000 tons of finished wire are annually turned out at this establishment, which, on the whole, is a model of well studied convenience and modern efficiency.

Thomson-Houston's electric welding apparatus is largely used in these works. Mr. C. G. Roebling, son of the late well-known engineer of this name, is president of this company. Messrs. Roelblings have also extensive warehouses or stores in New York, Chicago, and San Francisco.

Messrs. Washburn, Moen, & Co., of Worcester, Mass., founded by I. Washburn and B. Goddard in 1831, is one of the largest and most important concerns in the States. Their present works cover about 50 acres, and give employment to some 3000 hands; the premises have been twice demolished by fire. This company now manufactures all kinds of iron, steel, and copper wire, besides barbed fencing and wire ropes. In 1856 the firm commenced the manufacture of

tempered music wire, and in 1869 adopted a system of continuous rodrolling. The enterprise was turned into a company in 1868.

The works of the Aluminium, Brass, and Bronze Company at Bridgeport, Conn., are also worthy of mention amongst the important producers of wire across the Atlantic.

www.libtool.com.cn

CHAPTER III.

WIRE GAUGES AND OTHER TRADE CONSIDERATIONS.

PROBABLY the first definitely mentioned gauge or "size" for measuring the diameters of wire was that described in Lewis' "Philosophical Commerce of Art," published in 1745, and consisting of a brass plate provided with step-like notches. Hughes states in his pamphlet on the subject, that after a long and diligent search he failed to discover any wire gauge prior to 1842 that contained more than twenty-six sizes. The complications and confusions that subsequently developed themselves will be readily apparent upon examining the Table on the following page, which gives some examples of the variations in wire gauges used from 1866 to 1881, the sizes being expressed in 1000ths of an inch.

This epitomised tabulation presents a simple view of the incongruity then existing, but the magnitude and importance of the question is far more forcibly demonstrated by Hughes' treatise of 1879, and in which the author displays no less than fifty-five different gauges, forty-five of which were for measuring or determining the sizes of wire manufactured and sold within the United Kingdom.

Stubs, of Warrington, in 1843 commenced to gauge his wire by "mils," and this system was followed by Sir Joseph Whitworth in 1857. A year later J. Cocker, of Liverpool, advocated another standard of measurement. In 1867 Latimer Clarke, M.I.C.E., read a paper before the British Association, upon the "Birmingham wire gauge,"

TABLE OF OBSOLETE WIRE GAUGES USED FROM 1866 TO 1881.

	0	1	2	3	4	5	6	7	8	9	10	11	12	13	14	15	16	17	18	19	20		
LANCASHIRE GAUGES.	JOHNSON'S.....1879	.326	.300	.268	.254	.236	.210	.196	.178	.160	.144	.130	.118	.104	.094	.080	.070	.064	.056	.046	.042	.036	
		WHITECROSS'...1881	.320	.293	.268	.245	.227	.209	.190	.176	.159	.145	.127	.116	.104	.091	.079	.068	.062	.055	.047	.040	.035
			RYLANDS'1866	.326	.300	.274	.250	.229	.209	.191	.174	.159	.146	.133	.117	.100	.090	.079	.069	.062	.053	.047	.041
AVERAGE BIRMINGHAM GAUGES.	YORKSHIRE from HUGHES' } 1870	.320	.294	.270	.250	.231	.212	.197	.179	.160	.144	.130	.118	.102	.092	.083	.070	.065	.057	.048	.043	.038	
		STUBS'1879300	.284	.259	.238	.220	.203	.180	.165	.148	.134	.120	.109	.095	.083	.072	.065	.058	.049	.042	.035
		NETTLEFOLD'S1879	.340	.300	.284	.259	.238	.220	.203	.180	.165	.148	.134	.120	.109	.095	.083	.072	.065	.058	.049	.042	.035
OF LANCASHIRE BIRMINGHAM GAUGES.	BIRMINGHAM from HUGHES' } 1878302	.270	.258	.242	.216	.200	.182	.165	.148	.136	.121	.112	.097	.087	.075	.065	.061	.051	.046	.041	
		BIRMINGHAM from HUGHES' } 1878	.324	.296	.269	.255	.244	.213	.198	.184	.166	.149	.137	.122	.109	.096	.087	.075	.069	.061	.052	.045	.038
		LANCASHIRE BIRMINGHAM GAUGES299	.274	.252	.241	.216	.200	.182	.165	.148	.135	.121	.107	.096	.085	.074	.066	.060	.050	.044	.038

and subsequently proposed the adoption of his amended system.

www.libtool.com.cn
In a report by a special committee, appointed by the American Institute of Mining Engineers, published in 1877, it was proposed to abandon numbers for expressing certain sizes, and to adopt a gauge graduated according to thousandths of an inch, or the equivalents, as determined by the micrometer. The committee in question found that all existing wire gauges were only approximately correct, and that those made by different manufacturers all varied perceptibly.

Such a state of inaccuracy and incongruity naturally gave rise to annoyance, disputes and lawsuits, besides stimulating carelessness amongst the wire drawers. Later, the Yorkshire and Lancashire gauges, besides those of music, screw, pins, needles, and pinion wire, &c., became more or less indiscriminately incorporated under the denomination of the "Birmingham wire gauge." An example of the confusion thus arising is related by Hughes as following: "An order was received from New York for some copper wire of No. 32 gauge,—Warrington gauge being the size intended. The order was, however, given to a Birmingham manufacturer to execute, and who supplied the wire according to his gauge, with the result that after arrival it was found to be incorrect and consequently rejected. Now, No. 32, on the Warrington standard, equalled No. 36 on the Birmingham gauge, whilst the difference of price between the two sizes amounted to £129 per ton."

As the French and Germans had settled upon a standard wire gauge, based upon the millimetre, it was very natural that a strong agitation should be raised in this country in favour of establishing some similar provision.

In 1882 and the beginning of 1883 meetings were

accordingly held by our iron and steel manufacturers, with the view of discussing this important question, and arriving at some practical solution of the vexatious problem at issue. The association of manufacturers appeared at first considerably in favour of an amalgamation of gauges, *e.g.*, Lancashire sizes down to No. 20, and afterwards those of Yorkshire, which were further to be defined in thousandth parts of an inch. Consequently a memorial was addressed in July,

IMPERIAL STANDARD WIRE GAUGE.

Descriptive Numbers.	Equivalents in Fractions of an Inch.	Descriptive Numbers.	Equivalents in Fractions of an Inch.	Descriptive Numbers.	Equivalents in Fractions of an Inch.
7/0	.500	13	.092	32	.0108
6/0	.464	14	.080	33	.0100
5/0	.432	15	.072	34	.0092
4/0	.400	16	.064	35	.0084
3/0	.372	17	.056	36	.0076
2/0	.348	18	.048	37	.0068
1/0	.324	19	.040	38	.0060
1	.300	20	.036	39	.0052
2	.276	21	.032	40	.0048
3	.252	22	.028	41	.0044
4	.232	23	.024	42	.0040
5	.212	24	.022	43	.0036
6	.192	25	.020	44	.0032
7	.176	26	.018	45	.0028
8	.160	27	.0164	46	.0024
9	.144	28	.0148	47	.0020
10	.128	29	.0136	48	.0016
11	.116	30	.0124	49	.0012
12	.104	31	.0116	50	.0010

1882, to the Right Hon. J. Chamberlain, President of the Board of Trade, and which resulted in counter proposals of material difference to the scheme submitted. Deputations were then organised and a further memorial tendered defining the objections of the Manufacturers' Association to the suggested modifications of the Board of Trade authorities, the document being supported by Messrs. Johnson & Nephew, Rylands Bros., Nettlefolds Limited,

The Whitecross Company, Edelston & Williams, The Shropshire Iron Company, Ramsden & Camm, Greening & Sons, Royston & Co., A. Rollason, Frederick Smith & Co., &c. Further proposed amendments by the Board of Trade were again rejected by the Association in February, 1883, but shortly afterwards an understanding was mutually agreed upon, and which resulted in the inauguration of the "Imperial Standard Wire Gauge."

During September, 1883, the Board of Trade officially intimated to the manufacturers that their final system and schedule had been verified under the Weights and Measures Act of 1878, and in March, 1884, the new and long-sought uniform gauge became law, the denominations of which are given on the opposite page

The German millimetre equivalents to our standard gauge are now appended from a No. 5 rod to No. 35 gauge wire :

Number of English Standard W.G.	German Millimetre W.G. Equivalents.	Number of English Standard W.G.	German Millimetre W.G. Equivalents.
5	5.38	20	0.91
6	4.87	21	0.81
7	4.47	22	0.71
8	4.06	23	0.61
9	3.66	24	0.56
10	3.25	25	0.51
11	2.95	26	0.46
12	2.64	27	0.42
13	2.34	28	0.38
14	2.03	29	0.34
15	1.83	30	0.31
16	1.63	31	0.29
17	1.42	32	0.27
18	1.22	33	0.25
19	1.02	34	0.23
		35	0.21

In the United States of America many manufacturers designate the gauges they use after their own names, but practically they are nearly all precisely similar to Roebbling's

and Washburn-Moen's standard, now frequently termed "the National wire gauge," the comparative sizes of which are defined below in decimal parts of an inch.

Number of Wire Gauge. U.S.A.	Roebling's and Washburn-Moen's Gauge.	Brown and Sharpe's Gauge. U.S.A.	Equivalents in the English Legal Standard. S. W. G.
	in.	in.	in.
000000	.46464
00000	.43432
0000	.393	.46	.4
000	.362	.40964	.372
00	.331	.3648	.348
0	.307	.32495	.324
1	.283	.2893	.3
2	.263	.25763	.276
3	.244	.22942	.252
4	.225	.20431	.232
5	.207	.18194	.212
6	.192	.16202	.192
7	.177	.14428	.176
8	.162	.12849	.16
9	.148	.11443	.144
10	.135	.10189	.128
11	.12	.09074	.116
12	.105	.08081	.104
13	.092	.07196	.092
14	.08	.06408	.08
15	.072	.05706	.072
16	.063	.05082	.064
17	.054	.04525	.056
18	.047	.0403	.048
19	.041	.03589	.04
20	.035	.03196	.036
21	.032	.02846	.032
22	.028	.02534	.028
23	.025	.02257	.024
24	.023	.0201	.022
25	.02	.0179	.02
26	.018	.01594	.018
27	.017	.01419	.0164
28	.016	.01264	.0148
29	.015	.01125	.0136
30	.014	.01002	.0124
31	.0135	.00893	.0116
32	.013	.00795	.0108
33	.011	.00708	.01
34	.01	.0063	.0092
35	.0095	.00561	.0084
36	.009	.005	.0076

Although the "standard wire gauge" is the only legally recognised scale within our kingdom, nevertheless some manufacturers and engineers still persistently adhere to quoting Birmingham and other obsolete gauges; indeed, the writer has before him recent catalogues and specifications wherein "nearest B.W.G.," &c., is repeatedly referred to. This practice is not only superfluous and confusing, but a dangerous source of maintaining in circulation illegal standards, or the observance of irregular sizes which cannot be enforced by law.

Dr. Wedding, of Berlin, pointed out in 1885 that the wire export trade of Germany had, in certain districts, attained fully 60 per cent. of their production, and which had increased some fortyfold since 1850. Such thrifty and assiduous applications, combined with marked business enterprise and tact, are certainly praiseworthy, and doubtless are now appreciated as a justifiable basis of self-congratulation.

During a controversy which took place in a wire trade journal a few years ago it was pointed out that in 1877 the United Kingdom exported about 51,000 tons of iron and steel rods and wire, whilst Germany contributed some 32,000 tons of such products to outside markets. Seven years later, *i.e.*, by 1884, the state of affairs was, however, much altered, for, whilst our manufacturers were exporting some 53,000 tons, our Teutonic competitors exceeded 240,000 tons, and out of which over 50,000 tons were sent into Great Britain.

It may be here appropriately explained that very little plain wire is exported by Belgian manufacturers, although large quantities of wire nails and kindred products are annually distributed abroad. As German manufacturers, however, ship largely from Belgian ports, *e.g.*, Antwerp for America and Australia, &c., many may incorrectly conclude that wire thus transported has been produced in the country.

The writer has often observed the diligence with which some foreign firms apply themselves to a course of continual study and improvement, which in some cases is apparently superseded in this country by superficial knowledge and arrogance. On the other hand it may be perhaps advanced that some foreign contemporaries may not have been always particularly conscientious as to the manner in which they sometimes obtained their information and trade. The present, however, is a period of keen competition, in which conservatism, insular prejudices or lethargy are ill-adapted.

Reverting to the wire trade, it may have been concluded from examples cited, that, comparatively, there are no large factories in this country, therefore it should be mentioned that although we may not have moved sufficiently rapid to effectually hold our own in all branches of the industry, nevertheless superior grades of most English wire and manufactured products are still acknowledged to be the best obtainable throughout the world.

Amongst the more common grades of wire and wire products both our home and colonial trade have, apparently, of late years, suffered much from foreign competition. Indeed, it is incontestably clear that there are now large consumers of wire in this country who have been practically driven into Continental markets in order to get supplied with anything like promptness. This apparently inconsistent independence existing amongst some of our manufacturers may be deserving of censure, but unquestionably labour troubles, geographical disadvantages, and high inland freights have been largely the cause of the above-mentioned state of affairs.

In September, 1883, the Iron and Steel Wire Manufacturers' Association of this country sent a deputation to the goods managers of our leading railway companies to plead for a reduction of rates from the midlands to

London. At this time special through freights, allowed from the Continent to, say, Birmingham, were less than the railway charges for conveying goods from this city to London. During the December following the reasonable overtures of our manufacturers were rejected by the railway authorities, and it was not until some four years later that such unfair privileges were eradicated by the amendment of the Railways Act.

Railway rates on the Continent are far more favourable to export business than those in this country, whilst manufacturers possessing the advantage of water freights still further handicap our industries. For example, the present freight from Antwerp to London is very little more than the railway rate from Warrington to Liverpool, a distance of only twenty miles.

At one time the United States of America afforded a profitable field for the importation of wire billets and rods, besides various qualities of finished wire. Only a few years ago these imports exceeded 190,000 tons, but at present the trade is comparatively insignificant, and every year shows a marked decline as their home industries improve and develop. The amount of wire rods imported into the States during the nine months ending September, 1890, was about 43,500 tons, whilst that of wire and wire roping only comprised 3370 tons.

The falling off in this trade appears mainly attributable to the development of the wire industry in the States, for at this time the effects of the popular incubus, "The McKinley Tariff Bill," had not yet been felt, although it is not to be supposed that a measure that now extends from the humblest necessities of life to funereal exigencies should ignore all branches of the wire trade. It was a curious coincidence that the British Iron and Steel Institution should have met last autumn for the first time upon American soil just as its statesmen had shown their dislike

to European competition by enacting the most drastic duty law.

Large quantities of common fencing wire are annually shipped to the Australian and New Zealand colonies, but the greater part is now furnished by German manufacturers, who have spared no money or energy in extending their connections in every quarter of the habitable globe.

Manufacturers in the United States, owing to protective tariffs and consequent high prices of labour and materials, cannot profitably compete in the export trade of the outside world, but at present they have plenty to do to meet their own internal demands.

www.libtool.com.cn

CHAPTER IV.

ELECTRICAL CONDUCTORS.

THE scope of this volume will not permit of any lengthy dissertation upon electrical conductors generally, nor upon the multifarious scientific considerations involved in their applications, therefore it will be necessary to confine ourselves to matters bearing directly upon a few forms of uninsulated wires and specifications relating thereto.

Sir William Thomson in 1856 directed attention to the various conducting efficiencies of certain metals and the cause of fluctuations, &c. Four years later Mr. A. Mattheissen proved the variable conductivity of copper to be due to the presence of impurities, and established a standard of purity or conductivity almost universally accepted and used up to the present date.

Copper and its alloys form the best practical electrical conductors known, although for certain purposes iron and steel are extensively used. The conductivity of the first Atlantic cable, laid in 1856, is recorded as having been 50 per cent., whereas modern cables may have a conductivity of fully 98 per cent. This marked improvement is mainly attributable to the purity of the copper at present obtainable, and which, as mentioned in a previous chapter, may now be had practically pure. Taking Mattheissen's standard of pure copper as 100 per cent., some refined metal recently manufactured has exhibited an electrical conductivity equivalent to 103 per cent., but the efficiency is dependent upon temperature. Thus, it is possible for

the resistance of conductors to vary 10 or 15 per cent. between summer and winter in some parts of the world. The properties of hard and soft-drawn copper wire have been previously discussed in Chapter II., from which it will be remembered that the metal does not oxidise or corrode like iron or steel; on the other hand it lacks the elasticity characteristic of the latter. It has also been pointed out that hard-drawn copper wire has a greater tensile resistance than that of soft drawn, but its conductivity is slightly impaired. Many authorities consider that after years of service, copper conductors are rendered somewhat brittle by the influence of electric currents, whilst others support the properties of constancy and durability. The electrical conductivity of copper is six times that of iron. Hard-drawn alloys of copper containing small quantities of tin form strong and valuable conductors, amongst which class that of silicium-bronze may be incorporated. This and other similar alloys are further useful for resisting the action of air impregnated with salt, and as encountered in seaside localities. German silver is used for electrical conductors of high resistance, but this alloy is rendered decidedly brittle by age or service.

As Mattheissen's researches and tabulations upon the conductivity of copper were accomplished some sixty years ago, it is reasonable to conceive the possibility of their improvement. Readers interested in this important branch of the subject at issue should study Mattheissen's series of papers published in the Transactions of the Royal Society, and T. C. Fitzpatrick's paper read before the British Association last September, being an Appendix to the Report of the Committee on Electrical Standards.

Mattheissen found that impurities in copper sufficient to decrease its density from 8.94 to 8.90 produced a marked increase of electrical resistance.

Electrolytically deposited copper may have a very high

degree of conductivity. The specific gravity of copper wire may, however, be varied by the process of drawing, and therefore it is not necessarily entirely dependent upon the presence of impurities.

According to Fitzpatrick's recent experiments the difference between the density of hard-drawn and annealed copper wire is .0039. This gentleman's researches with electrolytically prepared copper wire, obtained by fusion within porcelain tubes through which hydrogen was passed, resulted in the following determinations :

Value of 1/3.	Temperature.	Weight of Wire.	Length of Wire for Determination of Resistance.	Length Cut and Weighed.	Resistance of Gramme per Metre.		Density.	Specific Resistance.
						deg.		
.28547	17.9	20.388	192.1	192.5	1574	18.3	8.90	1766
.28541	17.4	20.153	192.4	190.45	1569	17.5	8.90	1766
.28550	18.2	19.708	189.3	188.8	1577	18.6	8.91	1767
.28536	16.8	20.252	192.39	192.34	1561	17.1	8.92	1751
.28535	16.7	20.262	192.11	192.51	1563	17.2	8.93	1760

These values, reduced to a common temperature of 18 deg., gave a mean resistance of 1571 units per metre of hard-drawn copper wire. The above investigations closely support the general accuracy of Mattheissen's inquiries.

Mons. Lazare Weiller not long since presented to the Société Internationale des Electriciens the results of his experiments upon the electrical conductivity of certain metals and alloys, and as here appended :

1. Pure silver	100
2. „ copper	100
3. Refined and crystallised copper	99.9
4. Telegraphic silicious-bronze	98
5. Alloy of copper and silver (50 per cent.)	86.65
6. Pure gold	78
7. Silicide of copper with 4 per cent. of silicium	75

8. Silicide of copper with 12 per cent. of silicium	54.7
9. Pure aluminium	54.2
10. Tin with 12 per cent. of sodium	46.9
11. Telephonic silicious-bronze	35
12. Copper with 10 per cent. of lead... ..	30
13. Pure zinc	29.9
14. Telephonic phosphor-bronze	29
15. Silicious-brass with 25 per cent. of zinc	26.49
16. Brass with 35 per cent. of zinc	21.5
17. Phosphor tin	17.7
18. Alloy of gold and silver (50 per cent.)	16.12
19. Swedish iron	16
20. Pure Banca tin	15.45
21. Antimonial copper	12.7
22. Aluminium bronze (10 per cent.)... ..	12.6
23. Siemens' steel	12
24. Pure platinum	10.6
25. Copper with 10 per cent. of nickel	10.6
26. Cadmium amalgam (15 per cent.)	10.2
27. Dronier mercurial bronze	10.14
28. Arsenical copper (10 per cent.)	9.1
29. Pure lead	8.88
30. Bronze with 20 per cent. of tin	8.4
31. Pure nickel	7.89
32. Phosphor-bronze with 10 per cent. of tin	6.5
33. Phosphor copper with 9 per cent. of phosphorus	4.9
34. Antimony	3.88

The above comparative resistances may be reduced to ohms on the basis that a wire of pure silver, one millimetre in diameter, at a temperature of zero (C.) has a resistance of 19.37 ohms per kilometre.

In Chapter II., L. Weiller's valuable invention of silicious-bronze is discussed at some length, and here it may be mentioned that in France wires formed of this alloy are rapidly superseding those of iron and steel.

A comparison of the electrical qualities of iron and bronze wire demonstrates that a kilometre of the former, five millimetres in diameter, having a weight of 150 kilos., and an electrical resistance of 5.40 ohms, can be replaced by a silicious-bronze wire two millimetres in diameter with

THE BRITISH PHOSPHOR-BRONZE COMPANY'S
www.libtool.com.cn

TABLE OF WEIGHTS AND ELECTRICAL RESISTANCES OF WELLER'S
 PATENT SILICIUM-BRONZE WIRE.

					QUALITY A, FOR TELEGRAPH LINES, &C.	QUALITY B, FOR RAILWAY TELEGRAPH LINES, &C.	QUALITY C, FOR OVERHEAD TELEPHONE LINES, &C.	
Diameter in Mils.	Diameter in Millimetres.	Sectional Area in Millimetres.	Weight per Kilo- metre in Kilo- grammes.	Weight per Mile in Pounds.	Electrical Resist- ance at 0° C. in Ohms per Kilo.	Electrical Resist- ance at 32° F. in Ohms per Mile.	Electrical Resist- ance at 0° C. in Ohms per Kilo.	Electrical Resist- ance at 32° F. in Ohms per Mile.
158	4.0	12.5664	112.00	400	1.32	2.12	1.54	2.47
148	3.75	11.0446	98.44	348	1.51	2.42	1.83	2.94
138	3.50	9.6211	86.75	304	1.73	2.77	2.09	3.35
128	3.25	8.2968	73.94	261	2.01	3.22	2.13	3.86
118	3.0	7.0685	63.00	223	2.36	3.78	2.85	4.57
114	2.9	6.6052	58.87	210	2.53	4.05	3.05	4.90
110	2.8	6.1575	54.88	195	2.71	4.33	3.28	5.25
106	2.7	5.7255	51.03	181	2.91	4.65	3.52	5.64
102	2.6	5.3093	47.32	168	3.14	5.02	3.80	6.09
99	2.5	4.9087	43.75	155	3.40	5.44	4.11	6.60
95	2.4	4.5238	40.32	143	3.69	5.91	4.29	6.90
91	2.3	4.1547	37.03	131	4.02	6.43	4.46	7.15
87	2.2	3.8013	33.88	120	4.39	7.02	5.33	8.55
83	2.1	3.4636	30.87	110	4.82	7.71	5.82	9.32
79	2.0	3.1415	28.00	100	5.31	8.50	6.42	10.30
75	1.9	2.8352	25.27	92	5.89	9.43	7.00	11.26
71	1.8	2.5446	22.68	82	6.56	10.50	7.93	12.70
67	1.7	2.2698	20.23	73	7.37	11.79	8.89	14.25
63	1.6	2.0105	17.92	64	8.31	13.29	10.04	16.09
59	1.5	1.7671	15.75	55½	9.45	15.12	11.42	18.30
55	1.4	1.5393	13.72	48	10.85	17.36	13.11	21.00
51	1.3	1.3273	11.83	42	12.59	20.14	15.20	24.40
48	1.25	1.2272	10.93	38½	13.64	21.82	16.35	26.19
47	1.2	1.1309	10.08	36	14.77	23.63	17.87	28.80
43	1.1	0.9502	8.47	30	17.58	28.12	21.24	34.00
40	1.0	0.7854	7.00	25	21.28	34.00	25.70	42.00
36	0.9	0.6362	5.67	20				
31	0.8	0.5026	4.48	16				
Breaking strain of No. 14 B.W.G.					about 350 lb.	about 420 lb.	about 280 lb.	
Breaking strain of No. 18 B.W.G.	about 200 lb.	

a weight of 21 kilos, and an electrical resistance equal to 5.31 ohms. The kilomeric weights being in the proportion of 155 to 22, it follows, other things being equal, that the relative prices may vary to an inverse degree. Even when copper commanded a far higher price than it does at present, the uses of bronze conductors offered undoubted advantages, the difference in cost being largely compensated

Diameter in Millimetres.	Weight of Coil.	Length of Wire.	Relative Conductivity.	Electrical Resistance at Zero per Kilo.	Tensile Strength per Square Inch.	Number of Bends to a Right-Angle Bending Test.
<i>Telephonic Silicious-Bronze Wire.</i>						
	lb.	ft.	per cent.	ohms.	tons.	
$\frac{11}{10}$	33	5800	43	39.5	48.25	12
$\frac{12}{10}$	40	5850	43	33.2	48.89	12
$\frac{15}{10}$	55	5200	43	21.25	45.71	10
$\frac{18}{10}$	55	2925	43	11.95	44.44	8
<i>Telegraphic Silicious-Bronze Wire.</i>						
$\frac{5}{10}$	28.5	24368	102	80.5	26	8
$\frac{15}{10}$	63.8	5272	98.8	9.24	28.89	14
$\frac{20}{10}$	99.0	6031	98.8	5.20	29	9
$\frac{30}{10}$	122	2859	99.6	2.29	28.76	6
$\frac{45}{10}$	105.6	1247	99.0	1.02	28.57	4
<i>Copper Wire of High Conductivity.</i>						
$\frac{5}{10}$	30.8	26240	101.7	80.8	28.57	4
$\frac{7}{10}$	30.8	13408	100.7	41.7	28.57	4
$\frac{10}{10}$	61.6	13120	100.8	40.0	28.57	4
$\frac{24}{10}$	125.4	2303	102	1.74	28.57	4
$\frac{50}{10}$	118.8	1010	101	0.81	28.57	4

for by the almost indefinite period that they will last, while iron and steel corrode rapidly, and have practically little "scrap" value. Another benefit lies in the great lightness of the wires, which involves economies in transport, handling and fixing, the price of posts, and insulators, &c. Certainly at the present time the advantages are largely in favour of silicious-bronze, since at current rates it costs no

more than iron. At the International French Exhibition of 1889 the descriptions (on opposite page) of copper and silicious-bronze wire were shown by Mons. Weiller.

Where silicious-bronze wires have been employed for telegraphic purposes, their usefulness has been sometimes increased by making them also serve as telephone lines, *e.g.*, the two lines between Paris and Brussels, formed of four wires of three millimetres in diameter, with a total resistance of 1562 ohms, the distance between the two cities being 207 miles.

The electric light conductors laid by the Edison Company and others for the transmission of power by electricity, in the Paris boulevards, are formed of large cables of silicious-bronze, some of which have as much as 775 square millimetres of metallic section.

Below is given a Table of sizes, weights, and tests of hard-drawn copper wire as manufactured by Messrs. Frederick Smith & Co., of Halifax.

No.	Diameter in thousandths of an Inch.	Weight per Mile.	Breaking Strain.	Torsion in 3 inches.	Electrical Resistance per Mile.
		lb.	lb.	twists.	ohms.
8	.160	400	1200	8	2.3
9	.144	324	980	11	2.9
10	.128	256	700	15	3.6
11	.116	210	630	20	4.4
12	.104	169	530	25	5.45
13	.092	132	420	27	7
14	.080	100	330	30	9.2
15	.072	81	250	33	11.36
16	.064	64	220	36	14.38
17	.056	49	150	40	18.8
18	.048	36	115	45	25.5

Amongst the instructions issued by Messrs. Thomas Bolton & Sons for the erection of hard copper telegraph wire, the following may prove of interest to some readers. The wire should be handled as carefully as possible, and any flaws or kinks should be cut out. The coils of wire should be unwound from off revolving drums provided by

the manufacturers. Britannia jointing is the best method of connecting the wires or their binding attachments, and these should be subsequently sponged with "Baker's soldering fluid." It is important that the wire should be pulled up so that the strain upon it does not exceed one-fourth of its ultimate strength, and for which purpose the use of a ratchet vice, combined with a dynamometer, is recommended.

The annexed tabulation gives the proper tension and "sag" at different temperatures for a No. 14 G. wire, the

Size of Wire.	Span.	AT 22 DEG. FAHR.		AT 40 DEG. FAHR.		AT 58 DEG. FAHR.		AT 76 DEG. FAHR.	
		Hard Frost.		Ordinary Winter Temperature.		Average Summer Temperature.		High Summer Temperature.	
		Sag.	Tension.	Sag.	Tension.	Sag.	Tension.	Sag.	Tension.
No. 14	yds.	ft. in.	lb.	ft. in.	lb.	ft. in.	lb.	ft. in.	lb.
100 lb. per Mile.	100	2 8	80	3 7	59	4 4	49	4 11	43
	90	2 2	80	3 1	56	3 9	46	4 4	40
	80	1 8	80	2 7	53	3 2	42	3 9	36
	70	1 3	80	2 2	49	2 9	38	3 2	32
	60	11	80	1 9	44	2 3	34	2 8	28
50	8	80	1 5	38	1 10	29	2 2	24	

amount of the "sag" being constant in all cases, but the tension is proportional to the weight of wire used.

The tensile strength of hard-drawn copper wire may



FIG. 30.

attain 30 tons per square inch of sectional area, or nearly double that composed of ordinary soft or annealed copper.

Fig. 30 illustrates a "Britannia joint" such as before referred to, and now almost universally adopted for connecting telegraph lines. The ends of the wires are scraped

clean and then bound together by ordinary binding wire, after which the joint is rendered solid by soldering.

Our Post Office authorities require that hard-drawn copper wire supplied to them shall be of the lengths, sizes, weights, strengths and conductivities as set forth in the annexed Table.

Weight per Statute Mile.			Approximate Equivalent Diameter.			Minimum Breaking Weight.	Minimum No. of Twists in 3 inches.	Maximum Resistance per Mile of Wire (when hard) at 60 deg. Fahr.	Minimum Weight of each Piece (or Coil) of Wire.*
Required Standard.	Minimum.	Maximum.	Standard.	Minimum.	Maximum.				
lb.	lb.	lb.	mils.	mils.	mils.	lb.		ohms.	lbs.
100	97 $\frac{1}{2}$	102 $\frac{1}{2}$	79	78	80	330	30	9.10	50
150	146 $\frac{1}{4}$	153 $\frac{3}{4}$	97	95 $\frac{1}{2}$	98	490	25	6.05	50
200	195	205	112	110 $\frac{1}{2}$	113 $\frac{1}{2}$	650	20	4.53	50
400	390	410	158	153 $\frac{1}{2}$	160 $\frac{1}{4}$	1300	10	2.27	50

* Except in the case of pieces cut for testing, as provided for in the Specification.

The following are the requirements for the supply of hard copper wire strands :

$\frac{3}{16}$ Strand.	Weight per mile	111 $\frac{1}{2}$ lb.	108 lb.	115 lb.
	Breaking weight	350 lb.	...
	Resistance per mile at 60 deg. F.	8.1 ohms
	Weight of each coil	30 lb.	60 lb.

The length of the lay in the strand is to be 2 in.

All wire here referred to has to be free from any flaws or defects and of perfect cylindrical section ; every piece may be tested for ductility and tensile strength, &c. The wire has to be capable of being twisted six times round its own diameter without breaking. The conducting efficiency is calculated for a temperature of 60 deg. Fahr., each piece tested measuring not less than $\frac{1}{30}$ th part of an English statute mile. If 5 per cent. of any parcel of wire fail to come up to the standard specified, the whole of such lot is finally rejected. In the case of German

silver and platinoid wires supplied to our Post Office, the resistance of the former must not be less than twelve times that of pure copper, and in the latter not less than eighteen times. The first-mentioned alloy is to be composed of 57 per cent. of copper, 20 per cent. of nickel, and 23 per cent. of spelter. The wire must withstand an elongation of 10 per cent. without breaking, and all wires from 20 mils in diameter must be drawn through gams.

Iron and steel telegraph wire is usually made from charcoal puddled bars and mild Bessemer or Siemens steel, of tempers ranging about .60 to 0.10 per cent. carbons, giving a torsional efficiency of some fifteen to twenty twists in 6-in. lengths, with a tensile resistance of about 20 to 30 tons per square inch of section, and an elongation of, say, 10 to 14 per cent.

The electrical conductivity of iron and steel varies like copper, according to its metallic purity, and some authorities consider that the undue presence of manganese augments their resistance. Swedish charcoal iron wire, in about 100-lb. lengths, is much used for telegraph lines, but steel wire is preferred for long spans and where greater tensile strength is required. Galvanised wire is largely used for most situations—excepting smoky and sea-side districts, although it should be understood that the zinc coating is to some extent soluble in rain water, indeed its protective influence appears due to the formation of a film of oxide. If, however, any imperfections exist in the galvanisation the iron corrodes more rapidly than plain wire. Iron or steel wire employed for telegraph purposes should be highly ductile, homogeneous and free from all flaws and undue impurities, otherwise the wire is liable to fracture in frosty weather. The elongational efficiency of iron and steel wire is slightly diminished by the process of galvanising. The wire should be manufactured in reasonably long lengths free from any sort of welds electro welding is not allowed by our Post Office authori-

ties, but in America it is largely resorted to and apparently with satisfactory results so far as their requirements are concerned. In this country, wires of high conductivity and uniform strength, &c., are essential attributes for rapid and reliable working. In the United States the Thompson-Houston electric welding machine is largely used, and where some authorities consider its use does not diminish the strength or conductivity of the wire, whilst others admit a depreciation of some 5 per cent. in the former property. Telegraph wire used in our colonies is commonly of greater tensile strength than that employed at home.

Experiments and research made in Berlin support the contention that neither carbon nor silicon in iron or steel interferes with conductivity, but phosphorus and manganese are considered to decidedly influence this property. Paalzow and Wedding consider that high qualities of iron and steel telegraph wire should have an ultimate tensile resistance of about 23 tons per square inch of section, with an elongation of some 12 per cent., and that the sum of foreign elements present should not exceed .15 per cent. The metal should unquestionably have a fine grain and regular texture. Although joints in wires should be reduced as far as possible, the maximum convenient lengths of telegraph wires are controlled by weights most readily transported and handled. The employment of light wires means the use of small insulators and light supports, besides less leakage and electrical disturbance, &c., and constitute expedients which point favourably to the extended application of hard copper and silicium-bronze wires, &c.

The British Post Office telegraph authorities require that all galvanised iron wire supplied to them shall be in accordance with the following stipulations: The wire shall be uniformly cylindrical, well annealed, soft, pliable, and free from inequalities or flaws of any kind. The efficiency of the galvanising is tested by plunging pieces of the wire four times into saturated solutions of sulphate

silver and platinoid wires supplied to our Post Office, the resistance of the former must not be less than twelve times that of pure copper, and in the latter not less than eighteen times. The first-mentioned alloy is to be composed of 57 per cent. of copper, 20 per cent. of nickel, and 23 per cent. of spelter. The wire must withstand an elongation of 10 per cent. without breaking, and all wires from 20 mils in diameter must be drawn through gams.

Iron and steel telegraph wire is usually made from charcoal puddled bars and mild Bessemer or Siemens steel, of tempers ranging about .60 to 0.10 per cent. carbons, giving a torsional efficiency of some fifteen to twenty twists in 6-in. lengths, with a tensile resistance of about 20 to 30 tons per square inch of section, and an elongation of, say, 10 to 14 per cent.

The electrical conductivity of iron and steel varies like copper, according to its metallic purity, and some authorities consider that the undue presence of manganese augments their resistance. Swedish charcoal iron wire, in about 100-lb. lengths, is much used for telegraph lines, but steel wire is preferred for long spans and where greater tensile strength is required. Galvanised wire is largely used for most situations—excepting smoky and sea-side districts, although it should be understood that the zinc coating is to some extent soluble in rain water, indeed its protective influence appears due to the formation of a film of oxide. If, however, any imperfections exist in the galvanisation the iron corrodes more rapidly than plain wire. Iron or steel wire employed for telegraph purposes should be highly ductile, homogeneous and free from all flaws and undue impurities, otherwise the wire is liable to fracture in frosty weather. The elongational efficiency of iron and steel wire is slightly diminished by the process of galvanising. The wire should be manufactured in reasonably long lengths free from any sort of welds electro welding is not allowed by our Post Office authori-

ties, but in America it is largely resorted to and apparently with satisfactory results so far as their requirements are concerned. In this country, wires of high conductivity and uniform strength, &c., are essential attributes for rapid and reliable working. In the United States the Thompson-Houston electric welding machine is largely used, and where some authorities consider its use does not diminish the strength or conductivity of the wire, whilst others admit a depreciation of some 5 per cent. in the former property. Telegraph wire used in our colonies is commonly of greater tensile strength than that employed at home.

Experiments and research made in Berlin support the contention that neither carbon nor silicon in iron or steel interferes with conductivity, but phosphorus and manganese are considered to decidedly influence this property. Paalzow and Wedding consider that high qualities of iron and steel telegraph wire should have an ultimate tensile resistance of about 23 tons per square inch of section, with an elongation of some 12 per cent., and that the sum of foreign elements present should not exceed .15 per cent. The metal should unquestionably have a fine grain and regular texture. Although joints in wires should be reduced as far as possible, the maximum convenient lengths of telegraph wires are controlled by weights most readily transported and handled. The employment of light wires means the use of small insulators and light supports, besides less leakage and electrical disturbance, &c., and constitute expedients which point favourably to the extended application of hard copper and silicium-bronze wires, &c.

The British Post Office telegraph authorities require that all galvanised iron wire supplied to them shall be in accordance with the following stipulations: The wire shall be uniformly cylindrical, well annealed, soft, pliable, and free from inequalities or flaws of any kind. The efficiency of the galvanising is tested by plunging pieces of the wire four times into saturated solutions of sulphate

of copper at a temperature of 60 deg. Fahr., without showing any trace of metallic copper coating. Further, the wire is to be capable of withstanding repeated bending round bars of from $1\frac{1}{2}$ in. to $2\frac{1}{2}$ in. in diameter without the zinc coating exhibiting any signs of cracking or peeling. In order to prove freedom from splits or similar defects, the wire is drawn over four or more pulleys, arranged as shown in Fig. 31, and whereby it is stretched and

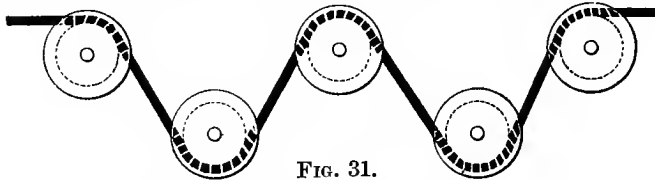

FIG. 31.

straightened with some degrees of severity. If during this test more than 5 per cent. of the pieces show any tendency to break or crack, the wire is rejected. Similar conditions are enforced with regard to crucial tests for determining the ductility and strength of the wire submitted for acceptance. The electrical resistance of the wire is calculated at 60 deg. Fahr., and the lengths of same subjected to experiments are not to measure less than $\frac{1}{30}$ th of a mile. If 10 per cent. of any parcel of wire submitted fail to pass all or any of the requirements specified in the appended Table, the entire batch is unconditionally rejected.

The following are the authorities' requirements for the supply of galvanised iron wire strand :

Strand Wire.	$\frac{3}{8}$	$\frac{5}{8}$	$\frac{7}{8}$	$\frac{7}{14}$	$\frac{3}{16}$	$\frac{5}{16}$
Length of spiral or lay in inches ...	8	10	11	$3\frac{3}{4}$	$2\frac{1}{4}$	$3\frac{1}{4}$
Weight of coils in pounds { minimum ...	105	110	120	112	84	112
... { maximum ...	180	200	210	140	112	140
Eye of coil, (Diameter { minimum ...	26	26	26	12	12	12
in inches) ... { maximum ...	30	30	30	13	13	13
Maximum resistance per mile of strand wire at 60 deg. Fahrenheit (in ohms)	42	...

COPY OF THE LATEST SPECIFICATION ISSUED BY THE BRITISH POSTAL TELEGRAPH AUTHORITIES
FOR THE SUPPLY OF GALVANISED IRON WIRE.

Weight per Mile.		Diameter.			Tests for Strength and Ductility.						Resistance per Mile at 60 deg. Fahr.		Constant, being Standard Weight by Resistance.		Weight of each Piece (or Coil).		Weight of each Bundle.		
															Minimum.	Maximum.	Minimum.	Maximum.	Minimum.
Required Standard.	lb.	800	767	833	242	237	247	2480	15	2550	14	2620	13	6.75	5400	90	120	90	120
Allowed.	lb.	600	571	629	209	204	214	1860	17	1910	16	1960	15	9.00	5400	90	120	90	120
Allowed.	lb.	450	424	477	181	176	186	1390	19	1425	18	1460	17	12.00	5400	90	120	90	120
Allowed.	lb.	400	377	424	171	166	176	1240	21	1270	20	1300	19	13.50	5400	90	120	90	120
Allowed.	lb.	200	190	213	121	118	620	30	638	28	655	26	27.00	5400	40	65	80	130	130

RAILWAY GALVANISED IRON TELEGRAPH WIRE.

Nominal Size (Centimetre Gauge).	Diameter.			Weight per Mile.			Minimum Breaking Weight for Stan- dard Diameter.	Minimum Number of Twists in Six Inches.	Maximum Resis- tance per Mile of the Standard Weight at 60 deg. Fahr.	Constant, being Standard Weight by Resistance.	Weight of each Bundle.		Minimum Weight of each Piece or Coil of Wire
	Required.	Minimum.	Maximum.	Required.	Minimum.	Maximum.					Minimum.	Maximum.	
No. 4	in. .24	in. .237	in. .247	lb. 800	lb. 767	lb. 833	lb. 2150	14	ohms. 7	5600	lb. 90	lb. 120	lb. 90
No. 7	in. .171	in. .165	in. .176	lb. 400	lb. 377	lb. 424	lb. 1075	20	12	4800	lb. 90	lb. 120	lb. 90
No. 10 $\frac{1}{2}$	in. .121	in. .118	in. .125	lb. 200	lb. 190	lb. 213	lb. 540	27	22	4400	lb. 30	lb. 112	lb. 40
No. 16	in. .066	in. .063	in. .069	lb. 60	lb. 55	lb. 65	...	in 8 in. 20	80	4800	lb. 28	lb. 112	lb. 5

NOTE.—In the case of wire not equalling the minimum breaking weight for standard diameter, as shown in the Table, the allowances named below will be conceded in consideration of the number of twists being above the minimum.

For No. 4 Wire—For each additional twist 40 lb. will be allowed, but in no case will a less breaking weight for standard diameter than 2000 lb. be accepted.

For No. 8 Wire—For each additional twist 20 lb. will be allowed, but in no case will a less breaking weight for standard diameter than 1020 lb. be accepted.

For No. 11 Wire—For each additional twist 10 lb. will be allowed, but in no case will a less breaking weight for standard diameter than 500 lb. be accepted.

Some of our railway electricians stipulate that all galvanised iron telegraph wire supplied to their companies shall be manufactured from best charcoal puddled bars, and be uniformly annealed and pliable, &c., whilst any flaws, splits, or inequalities in the metal or galvanising, are guarded against by testing, as before explained.

The Table on the preceding page gives the latest requirements of one of the leading railway companies of the United Kingdom, in respect to the supply of galvanised iron telegraph wire.

The requirements of another large railway company in this country, in regard to the supply of the class of wire under consideration, are now appended :

Nominal Size.	Diameter.			Weight per Mile.			Minimum Breaking Weight.	Minimum Number of Twists without Breaking in Six Inches.	Maximum Resistance per Mile of Standard Weight at 60 deg. Fahr.	Constants, being Standard Weight and Resistance.	Weight of each Coil.		Minimum Weight of each Piece of Wire.
	Required Standard.	Minimum.	Maximum.	Required Standard.	Minimum.	Maximum.					Minimum.	Maximum.	
8	.171	.166	.176	400	377	424	1100	20	12	4800	90	120	90
11	.121	.118	.125	200	190	213	600	27	24	4800	80	112	56
16	.066	.063	.069	60	55	65	...	20	80	4800	28	112	5

The wire is to be manufactured from charcoal puddled bars, and be uniformly annealed, soft, pliable, smoothly galvanised, free from scale, inequality, flaws, splits, and other defects, cylindrical in form, and of the sizes mentioned in the annexed Table as applied to the standard specified, further, it is to possess the electrical and mechanical qualifications therein stipulated.

The wire is to be drawn in continuous pieces or lengths of weights not less than those given in the Table. Each

piece is to be warranted not to contain any weld, joint, or splice whatever, either in the rod before it is drawn, or in the finished wire.

After having been well galvanised, the wire is to be stretched ("killed") to the extent of 2 per cent., and be uniformly coiled so as to contain no bends or sinuosities.

The wire is to be capable of passing the electrical and mechanical tests specified.

The galvanising of the wire is to be capable of standing the following tests: The samples selected shall be plunged into a saturated solution of sulphate of copper, at 60 deg. Fahr., and retained there one minute; it shall then be withdrawn and wiped dry; this process shall be performed four times. If the sample retains a reddish deposit of metallic copper, it shall be accepted as proof that the coating of zinc is not satisfactory.

Compound telegraph wires composed of steel cores and copper coatings, &c., for obtaining higher conductivity and greater strength than iron wire, is not practically known or used in this country, although our American contemporaries have tried such form of conductors to a considerable extent.

Opposite this page is given Messrs. W. T. Glover & Co.'s Table of the relative dimensions, lengths, resistances, and weights of pure copper wire.

Fig. 32 of the accompanying illustration represents Messrs. Glover's new standard wire gauge, for measuring

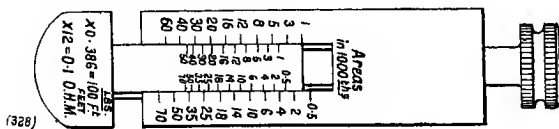

FIG. 32.

electrical and other wires. It will be observed that by the use of this instrument, which is actuated by a thumb-screw, the diameter of any wire may be determined in

www.libtool.com.cn

Missing Page

www.libtool.com.cn

fractions of an inch or in millimetres. The standard wire gauge vernier is read by observing the numbers of the coincident graduations. For example, assume a wire be nipped in the gauge and shows the graduation between 16 and 20, *i.e.*, 18, then the corresponding scale indicates 18, or the number of the S.W.G. The inch scale measures in mils or thousandths of an inch; each division on the scale being $\frac{1}{1000}$ or $\frac{20}{10000}$, and is read as follows: Each division passed by an arrow head counts twenty, and when the reading is such that the arrow head passes one of the divisions, but fails to reach the next, then the vernier is consulted, and that graduation which coincides with any one on the scale is the number which must be added to the twenties of the scale to give the exact diameter in thousandths of an inch. If the wire is less than 20 mils in diameter the size is taken from the vernier only.

Now assume a No. 8 S.W.G. wire be nipped, when it will be seen that the inch scale reads 0.160, the millimetre scale a shade over 4, whilst the scale of areas registers 20, this giving at the same time the current in ampères (20) that the wire will safely carry. The area multiplied by .4 gives 8 lb. per 100 ft., and so on throughout the other calculations as to resistance, horse-power, &c.

On the back of the gauge is a scale by which the areas of circles, whose diameters are nipped between the jaws, may be approximately measured in thousandths of a square inch. This scale reads like that of the S.W.G., *i.e.*, numbers which coincide give the reading.

From this scale may be computed the capacity of high-conductivity copper wire for carrying an electric current by any of the well-known formulæ; but it is found that at all events up to No. 6 S.W.G., 1000 ampères to the square inch is generally satisfactory, from considerations of both economy and resistance. The scale of areas may then generally be taken as a scale of ampères.

If the area be multiplied by 12.33, the result is the length in feet of pure copper wire, having a resistance of $\frac{1}{10}$ of an ohm.

42.8 divided by the area gives the resistance in ohms per mile ($42.8 \div \text{area} = \frac{\text{ohms}}{\text{mile}}$).

The area multiplied by 0.4 gives the weight in pounds of a length of 100 ft.

The area multiplied by 0.645 equals 1 ampère to 1 square millimetre, and similarly by 0.0575 gives the horse-power lost per mile, with 1000 ampères per square inch, &c.

www.libtool.com.cn

SECTION II.

WORKED WIRE AND ITS APPLICATIONS.

CHAPTER V.

THE MANUFACTURE AND USES OF WIRE ROPES.

THE manufacture and application of ropes composed of metallic filaments or wires appear to have originated in Germany in about the year 1821, and in the following year we may find records concerning their utilisation as supporting ropes for the Geneva suspension bridge. These were, however, of the "selvagee" type of construction, *i.e.*, composed of a series of parallel wires bound together by an external serving of finer wires. Shortly afterwards "formed or stranded" wire ropes were manufactured in this part of the Continent, and Germany is fairly entitled to the credit of the practical inauguration of this now extensive and important industry.

In these early days of the industry charcoal or B B iron wires were probably exclusively used, but within the last fifteen years or so steel wires have almost entirely superseded their employment. Although the manufacture and application of wire ropes were known in Germany some sixty-nine years ago, their practical introduction into this country did not apparently transpire until fully seventeen years afterwards.

In 1837 *The Mining Journal* and *The Mechanics' Magazine* published a translation of a communication made by one Albert, of Clausthal, to a society in Berlin, concerning the manufacture of stranded iron wire ropes, similar in con-

struction to those of hemp previously used. Albert has since been universally accepted as the true inventor of wire roping as now recognised, although it may be mentioned that a J. Wilson, of Derby, has somewhat recently laid public claim to having made stranded wire ropes in 1832 for the Haydock Collieries in Lancashire. In the volumes above stated it does not appear that Albert produced a wire rope prior to 1834. In these records we may read that about the last-mentioned date Albert made an iron wire rope by hand, owing to the unsatisfactory lives of the hempen ropes then used in the Hartz mines. The wire used for this purpose is stated as having been .144 in. in diameter, and the price then paid for the same equivalent to £1 7s. per cwt. Hand vices and wrenches were used for the purposes of twisting up the strands and closing the same into rope. The latter were provided with five holes, $\frac{3}{16}$ in. in diameter, and some eighty to ninety intermediate perforated boards, 6 in. square, were also employed in the manufacture.

For carrying out this primitive fabrication a rope walk of some 130 ft. in length was required, whilst the expense of producing 3920 ft. of rope is given as £31 10s. Each wire used in the manufacture had a tensile resistance of 10 cwt. These hand-made metallic ropes were tried for raising ore in the shafts of the Hartz mines, and it is stated they gave very satisfactory results.

Immediately after this practical demonstration, Messrs. Felten & Guilleaume, of Cologne, commenced the manufacture of wire ropes upon a commercial scale.

On the 20th of June, 1838, Mr. Newall, of Dundee, received a letter from a friend who was studying mining in Saxony, which contained the following paragraph: "Ordinary ropes are quite out of fashion in the mines here; all are now cables of iron wire—four wires, $\frac{3}{8}$ in. thick, being twisted together, and four, six, or eight of

these combined to make a cable, lighter, stronger, and more economical by far than a hemp rope for the same purpose. Invent a machine for making them. It is very simply done here, as you can imagine, but slow and unscientific," &c. It is to be regretted that the name of the writer of this initiative letter has not publicly transpired, for as much credit appears due to this gentleman for his valuable communication as to Mr. Newall for promptly following his correspondent's advice and information.

Within a month from the receipt of the above-mentioned letter Mr. Newall had designed a machine for manufacturing ropes of four strands, composed of four wires in each, and towards the close of July, 1838, he sent a drawing of the same to his friend in Saxony, who acknowledged the design with approval on the 24th of the same month; further, enclosing a description of the method practised by Albert, now Director of the Hanoverian Mines, and the stated inventor of wire ropes on the Continent. It is also recorded that some of Mr. Newall's early experiments were carried out in his father's garden. In August, 1840, he obtained his first letters patent in this country for improvements in the manufacture of ropes, and in machinery for carrying the same into practical effect. These inventions related to the production of wire roping in which wires were laid around a core to form a strand, which in their turn were laid around another central heart to form a rope, the wire forming the strands and the latter forming the rope, being kept at equal distances from their centres. Some ingenuity had also to be displayed in designing the machine, in order to prevent any twisting of the individual wires when spinning a strand. A partnership was forthwith arranged for the purpose of working these inventions on a commercial scale, and Mr. Newall became the manager of the business, which was continued in the

same form until October, 1886, when Mr. Newall retired from the firm and re-established himself at Washington, Durham, under the title of R. S. Newall & Son.

On the 21st of April, 1889, Alderman R. S. Newall died at his residence at Gateshead-on-Tyne, and shortly afterwards the following interesting information was published. Mr. Newall was a native of Dundee, and here his earliest experiments in wire ropemaking were executed. About forty-eight years ago he came to the Tyneside, and with Mr. C. Liddell and Professor L. D. Gordon—formerly of the Glasgow University—erected works in the Teams district of the rising town of Gateshead. The factory is still carried on by a limited company now styled Messrs. Dixon, Corbett, & Newall. Mr. Newall was also the proprietor of the Washington Chemical Works. The deceased gentleman's firm also manufactured half of the first Atlantic submarine telegraph cable. Mr. Newall's mind was not, however, solely occupied in matters concerning his own business and personal welfare, for many of his spare moments were assiduously applied to astronomical research, for which he possessed a natural bent, and some twenty years ago he erected a telescope of world-wide reputation; in fact, at the time the largest instrument of the kind made. Mr. Marth, the well-known astronomer, was employed for some years at Mr. Newall's observatory. In March, 1889, Mr. Newall offered his magnificent instrument to the Cambridge University.

Since the death of Mr. Newall a letter has appeared in the *Newcastle Leader*, from Mr. J. B. Wilson, disputing Mr. Newall's claim to the introduction of the manufacture at issue. Mr. Wilson claims that he was the first to manufacture wire ropes in this country, and states that in about 1832 he received and executed an order for a wire rope. Mr. Wilson further mentions Sir Charles Lemon, Bart., John Bassett, F. Foster, Daglish,

Vivian, Loam, Hunt, and Taylor, &c., as amongst the very first users of wire ropes in this country.

At a meeting of the British Association held at Newcastle in 1838, Mr. Taylor, F.R.S., read a paper by Count Brenner on "Wire Ropes."

It will now be apparent that our practical introduction of the manufacture under consideration took place about the time of the construction of the old Blackwall rope railway, *i.e.*, between 1838 and 1840.

Reverting to the original or "selvagee" construction, it may be mentioned that this is still theoretically the strongest form of rope known, although it possesses disadvantages. Many of our readers may be aware that this was the type adopted for the colossal suspension ropes of the celebrated New York and Brooklyn Bridge, U.S.A.

The "selvagee" construction consisted originally of a number of parallel unannealed iron wires of about 0.11 in. to 0.06 in. diameter, bound together as before mentioned with finer wire of about 0.03 in. diameter, over which servings of woollen list and tarred yarn were finally wound. The process of manufacture was effected by "warping" wires over two hooks—fixed at different distances apart according to length of rope required—to and fro a sufficient number of times to form the diameter required to withstand a determined strain. Such a construction of rope was used for the Freiburg Suspension Bridge in 1835, which presented a clear span of over 800 ft. These were composed of some twenty bundles of straight parallel iron wires 0.125 in. diameter, with servings so as to form ropes of about $5\frac{1}{2}$ in. diameter. This construction was evidently difficult to effectually splice, besides being rigid and non-elastic; although, on the other hand, it presented a strength nearly equal to the aggregate resistance of the individual component wires, whereas in

twisted or stranded ropes about from 10 to 15 per cent. of tensile strength may be sacrificed.

The principle of twisting wires around hempen or metallic cores to form strands, and afterwards similarly closing these around central hearts to make roping, is obviously a repetition of the methods adopted in the manufacture of vegetable or fibre ropes and cordage.

Wire ropes, like those originally composed of hemp, were at first, as before stated, made in primitive fashions upon "rope walks," and afterwards in fibre roping machines of early designs, with which in this country the name of Cartwright will always remain familiar, in conjunction with those of his followers Captain Huddart and Archibald Smith.

The first "formed or stranded" wire ropes were made of soft annealed iron wires of about 0.085 in. diameter, twisted into strands of little regularity, and four of these spirals were laid up into a rope. The lay in these strands was generally of about 1 ft. pitch, and a certain amount of permanent set was enforced in order to keep the rope together. This construction was soon found to give considerable flexibility and facilities for splicing, fitting, &c.; but the softness of the wires, combined with irregularities of manufacture and disproportionate lays in the rope, caused them to wear out rapidly.

Amongst the earliest followers of this industry the names of Stephenson, Wilkins, and Weatherley, &c., will be familiar to some, and again that of Elliot, who has been identified with the manufacture of cables and ropes since 1844. The late Peter Haggie was also actively associated with the establishment of the enterprise, whilst the name of William Bullivant similarly stands prominent upon the list of inventors and pioneers of the industry, and will be intimate to many in connection with the introduction of flexible steel hawsers for marine and other purposes, which

have been so largely used by the British and foreign Governments, &c., in lieu of chains and hempen ropes.

In order that the general requirements, arrangements, and equipments of a first-class modern wire rope works may be understood, we will now pause to examine some of the salient features presented in Messrs. Bullivant & Co.'s new and extensive premises at Millwall, E. These works stand on an eligible site, situated on the north bank of the River Thames opposite Rotherhithe, having a quay and fine water frontage.

The strand-making and rope-closing department has an area of about 25,000 square feet, and here wire ropes for marine, mining, railway, agricultural, and other analogous purposes may be seen daily in different stages of manufacture with the most modern appliances. Amongst the numerous apparatus will be found 3, 6, 8, 10, 12, 18, and 24-bobbin stranding machines, and some of the largest and most powerful rope-closing machinery in existence.

All classes of iron and steel wire are used in the different manufactures executed at these works, from 0.012 in. to .212 S.W. gauge, and some ropes are produced which present an ultimate tensile resistance up to 150 tons per square inch of sectional area.

Wire ropes can now be manufactured with a high degree of flexibility, dependent upon the material and fineness of wire employed, and is a speciality to which this firm has given much attention.

Hawsers, rigging and stranding ropes are usually composed of galvanised wires, whilst mining and haulage ropes are commonly made of black wires, as the process of galvanising somewhat deteriorates the property of the metal.

Wires used in the different manufactures of roping, torpedo and wire netting, &c., are kept in the stores which adjoin the water side, and here preliminary testing experiments are conducted, the various coils being cleansed in

either an alkaline or acid solution before being used. The galvanising shop contains several baths of molten "spelter" metal especially arranged and equipped for the treatment of wire, and it may be mentioned that particular care has to be exercised with steel wire, otherwise crystallisation may ensue, and thus the wire be rendered exceedingly hard and brittle. The process is simple, *e.g.*, the wire to be treated is unwound from off reels and drawn through the alkaline or acid liquor, and thence through the galvanising bath of molten "spelter." Upon emerging from the latter it is passed through a bed of sand, to remove any superfluous metal, and is finally rewound upon suitable reels or bobbins. The galvanised wire is afterwards subjected to mechanical tests, in order to determine its strength and flexibility.

Here it may be desirable to give a few particulars concerning the construction of different kinds of ropes as sometimes described by conventional names in the trade. For example, a "laid rope" consists of a heart composed of a strand of either hemp or wire around which are twisted six strands containing a similar heart covered with six wires. A "formed rope" comprises six strands laid round a heart as just explained, but each strand contains a larger number of component wires, *e.g.*, round the six wires above mentioned a further outside layer of twelve would be laid, thus making eighteen wires in all, independent of the core. Thirdly, a "cable laid rope" consists of six laid ropes closed together to form one cable—as in ordinary hemp roping—and is sometimes used for obtaining certain large sizes, although Messrs. Bullivant & Co. consider the construction far from desirable whenever it can be avoided.

By way of further exemplification, it may be cited that a laid rope of 2 in. to 3 in. circumference as applicable to railway haulage purposes, &c., might be composed of six strands each of seven wires of 16 or 12 S.W. gauge

respectively. A mine winding rope, say 4 in. in circumference, could be constructed as a laid or formed rope; thus of six strands of seven wires of eight gauge or of six strands each of nineteen wires, including core, of 14 S.W. gauge respectively. A 6-in. circumference flexible rope would be preferably made of six strands of thirty wires all of 13 S.W. gauge, *i.e.*, each strand would have a hempen centre covered with layers of twelve and then eighteen wires. A hawser, say 12 in. in circumference, would usually be made at these works of six strands containing sixty-one wires each, *i.e.*, each strand would be composed of consecutive layers of seven, twelve, eighteen, and twenty-four wires. A smaller sized "hawser" could be constructed of six strands of twelve wires.

The flexibility of wire ropes is mainly dependent upon the multiplication of their component wires and the manner in which they are laid together, and at the works at issue ropes containing from twelve to four hundred wires are constantly being manufactured. It is comparatively easy to make a rope containing a few wires, but considerable skill and experience is required as the number increases, in order to arrange the wires and their lays so that each component wire shall bear its due and proportionate amount of working strain.

As an example of a cable laid rope, we may take one, say, 5 in. in circumference, composed of 252 wires of 17 S.W. gauge, weighing 9.4 lb. per yard, and presenting a breaking strength of about 36 tons when mild steel wires are used.

The cores or hearts of wire ropes and their strands may be composed of either compact hemp or soft wire; the former material, however, produces a more flexible rope. Iron and mild steel wires are used for the centres of ropes required to withstand higher tensile strains, these metals being selected on account of their softness and

ductility. For ropes of great flexibility, the cores of the strands are usually composed of hemp. Italian hemp is stronger than Russian, whilst oiled or tarred hems are weaker than those untreated; however, it is usual to steep the hemp in hot linseed or other vegetable oil. The presence of any acid is highly detrimental to the life of a wire rope.

We will now examine some modern types of wire strand-forming and rope-closing machinery employed upon these important premises, and with such object direct attention to the illustrations shown at Figs. 1 and 2. The first figure represents a side elevation of a 24-bobbin strand-making machine of the most modern type, and it will be readily understood that a number of such machines are employed in these works, the number of bobbins in the same varying according to the class of strands to be manufactured. The selected wires of requisite gauge are contained or coiled upon the bobbins shown mounted in the "flyers," carried by the circular frame which is fixed to a horizontal shaft mounted in bearings, so as to be free to revolve through the intervention of appropriate gearing. The outer ends of the wires are passed through apertures provided in the annular framing and nozzle plate running in the headstock bearing, and thence are carried through the fixed closing block or die—shown closed by means of the weighted lever—to the draw-off drums. The hempen or wire core is drawn in centrally from the back of the machine through the tubular horizontal shaft, and as the machine revolves and draws in the core the wires are twisted spirally round the same. The tandem grouping or arrangement of the bobbins is worthy of notice, and consequent easy angle at which the wires are concentrated at the nozzle plate and drawn through the closing die. In this manner the strands are twisted up without bending or straining the component wires, whilst any undue slack

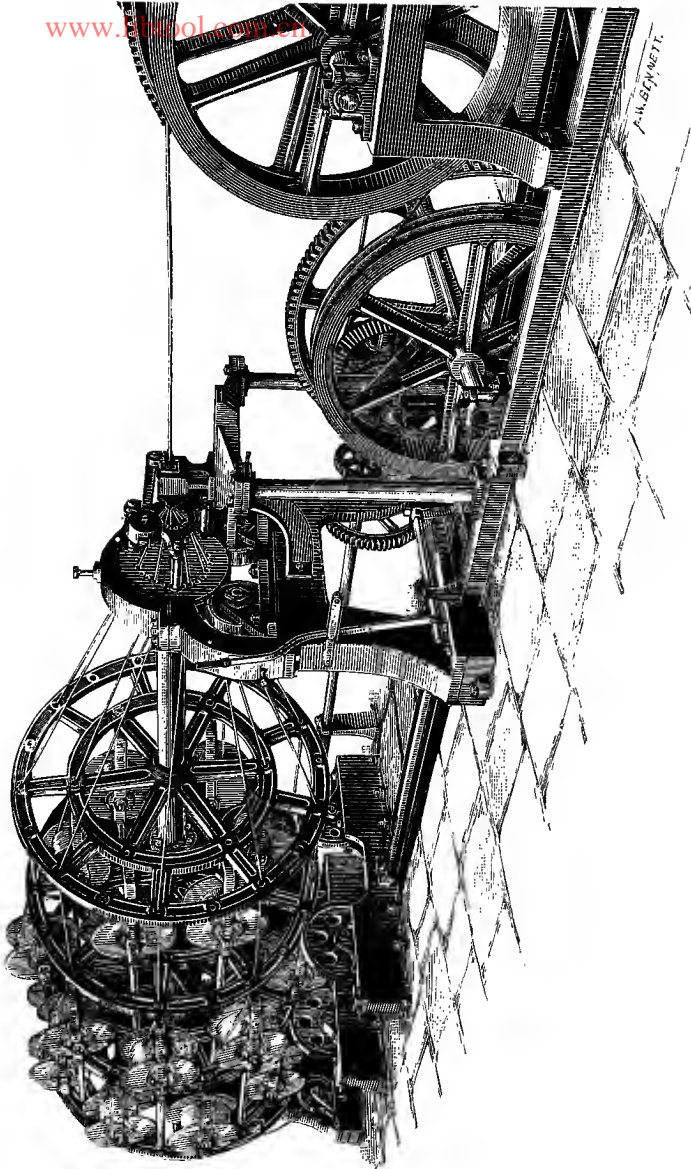

FIG. 1. 24-BOBBIN STRANDING MACHINE.

www.libtool.com.cn

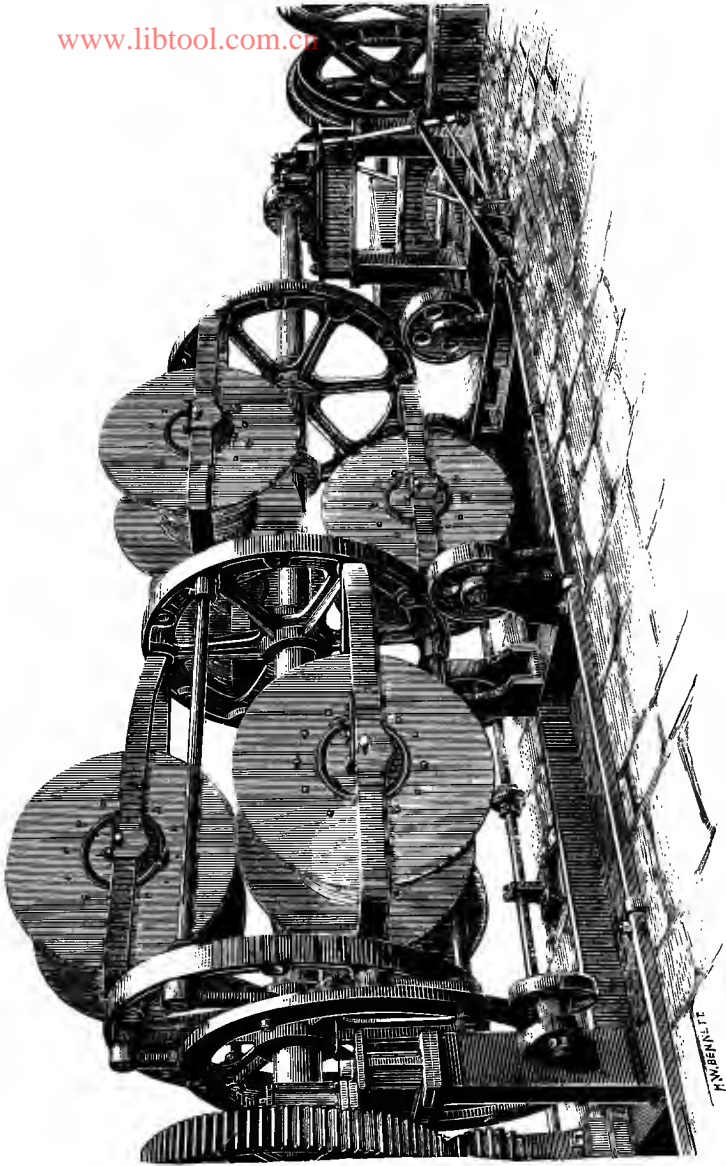

FIG. 2. LARGE ROPE-CLOSING MACHINE.

www.libtool.com.cn

arising from any unequal running of the bobbins is ingeniously pushed back from the aforesaid die. The bobbins mounted in the flyers, or fork-shaped frames, are controlled by an eccentric motion at the back of the machine—as shown in the closing machine, Fig. 2—so that whilst the circular carrying frame revolves they are always maintained in a vertical attitude, in order to prevent any individual twisting of the wires. Each bobbin is mounted on an independent transverse axis and provided with a tension band and adjusting screw, so that they may be set to pay the wire out uniformly. The draw-off drum at the opposite end of the machine is driven by a train of gearing, actuated by a spurwheel fixed on the revolving portion of the machine, and are proportioned to drive the said drum at a determined peripheral speed, in order to obtain a required length of lay in the strand. In other words, as the revolving portion of the machine makes one complete revolution the draw-off drum receives an angular movement dependent upon the proportion of lay desired, the variation of lays being obtained by the employment of “change wheels.” The finished strands are wound upon reels or bobbins, and are afterwards placed in the flyers of the closing or rope-making machines, such as represented at Fig. 2, before referred to. This only differs from the stranding machine explained, inasmuch that the bobbins are usually confined to six in number, and that they are loaded with strands in lieu of wires. Closing machines are, however, run at lower speeds, *e.g.*, from 30 to 50 revolutions per minute, whilst those for stranding are run up to from 75 to 150 revolutions, and some of the Archibald Smith type of machines even up to 300 revolutions per minute. Messrs. Bullivant & Co. possess some of the last-mentioned description of stranding machines, besides those above described. Readers who are interested in older types of plant may find descriptions and illustrations

of such machines in Spon's "Dictionary of Engineering," whilst those desirous of seeking more exhaustive particulars concerning early hemp ropemaking should consult C. P. Shelley's paper on the subject, read before the Institute of Mechanical Engineers in 1862.

When it is required to form strands in long continuous lengths, the wires are generally separately united by brazing or welding. Later on we shall have occasion to refer to a construction of compound machine whereby a rope can be made of any length in one continuous piece. It should also be borne in mind that in manufacturing wire ropes of the ordinary construction the wires forming the strands are laid or twisted to the left hand, whilst the strands forming the rope are closed to the right hand or opposite direction.

The newest form of stranding machine employed by this firm for certain classes of work is one constructed according to Mr. Stone's invention, of U.S.A., and it is claimed to possess economical advantages on account of the high speeds at which it may be driven. The machine further simultaneously spins up a strand of nineteen to thirty-seven wires, or such number as may be required, at one operation.

The large rope-closing machine of Messrs. Bullivant's illustrated at Fig. 2, is capable of producing a rope up to 21 in. in circumference. Such a rope would have a breaking strain of about 1200 tons. About twelve years ago the largest wire rope did not exceed 7 in. in circumference. The smallest sized rope now in general demand is about $\frac{3}{4}$ in. in circumference, but smaller ones are made for special purposes.

Considerable space is devoted at Messrs. Bullivant's works to the manufacture of wire netting besides that of torpedo nets, which have now been successfully applied to the principal vessels of the British and European navies. The latter measure 15 ft. by 20 ft., and are composed of a

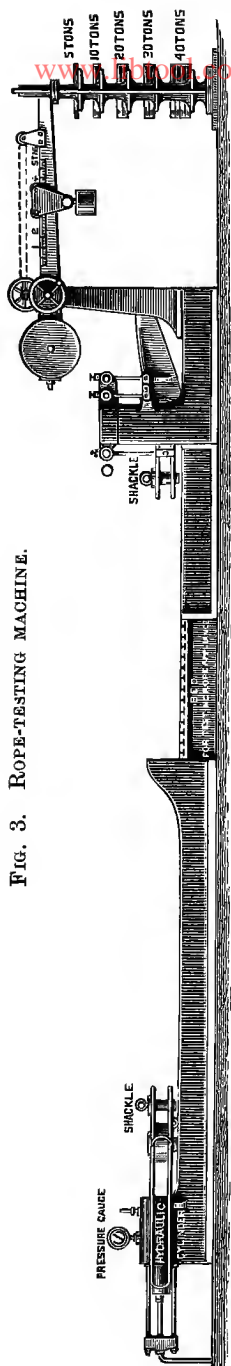

combination of steel wire grummetts secured by small rings so as to withstand an impact of from 6 to 8 tons.

The firm's galvanising works are necessarily of an extensive character and as may be gathered from the fact that their monthly consumption of "spelter" ranges from 100 to 125 tons for treating their own products, and for which purpose six baths are kept almost continually employed.

For the past five or six years the firm has been most successfully engaged in the manufacture of wire netting on a very large scale and in connection with which they have displayed considerable ability. Amongst their many ingenious devices that designed for tight rolling netting for shipment is particularly worthy of mention. A later chapter will, however, be devoted to the manufacture of wire netting and kindred products.

Wire-testing machines of modern types are provided on the premises, supplemented by an hydraulic rope-testing machine of efficient and powerful design. This appliance is represented in side elevation at Fig. 3, and consists in an arrangement of compound levers which work in combination with an hydraulic ram. The horizontal lever, to the right hand of the apparatus, is mounted on a suitable pillar fulcrum, the short end being

www.libtool.com.cn
provided with an adjustable counterweight, whilst the long arm thereof is arranged to receive weights of from 1 cwt. to 100 tons. A scale of 1 cwt. to 5 tons is further indicated upon the main arm of the lever, along which a travelling weight may be caused to traverse. The terminal shackle of this portion of the machine is connected with the lever by means of links, a bell-crank, and vertical rod. The ram of the hydraulic apparatus at the opposite end is fitted with a crosshead to which links are attached in communication with the second holding shackle. It will now be understood that when it is desired to ascertain the strength of any rope, a convenient length thereof is fastened between the two shackles and hydraulic pressure applied. The breaking strain is indicated by the sum of the weights applied, plus the reading on the graduated lever or beam.

Messrs. Bullivant & Co. certainly possess a great advantage from their water side accommodation, and, indeed, in these times of keen competition a good geographical position is by no means to be underrated. Many of the wire factories in the Midlands are sadly handicapped by heavy railway freights for transportation.

Later on in this chapter further strand and rope-making machinery will be described.

Having made ourselves acquainted with the general history and proceedings, &c., connected with the manufacture of wire ropes, we will proceed to consider some of the more or less special productions at present in the market.

At this stage it will not be inappropriate to offer a few remarks upon the construction and uses of flat wire ropes, although a manufacture at present comparatively little in demand. Flat wire ropes were originally composed of from six to twelve "formed" strands, of alternate lays, arranged side by side, to form the warp, and these were laced together with strong yarn. This method of construction

was, however, soon discarded, owing to the rapid wear of the binding yarns. Afterwards this type of roping was formed of four, six, or more round ropes, of alternate lays, sewn together by wires in a zigzag direction. Flat ropes at one time were considered safer than cylindrical ones, and less liable to twist and spin, but of late they are little used, except in cases where old arrangements of plant necessitate their employment.

By way of comparison let us examine the difference presented by a flat rope of $3\frac{1}{4}$ in. by $\frac{5}{8}$ in. and a round rope $3\frac{7}{8}$ in. in circumference, both constructed of steel wires, and having an approximate breaking strain of 50 tons. In the first place, the round rope would be about $1\frac{1}{4}$ in. in diameter, and could be more snugly coiled upon a drum, and further, would weigh some 15 lb. per fathom, as against 18 lb. in the flat rope. According to some manufacturers' practice, flat and round winding ropes may be composed of iron wire of, say, 30 tons strength per square inch, Bessemer steel wire of 40 tons, patent steel wire of 80 to 90 tons, or of plough steel wire of from 100 to 120 tons resistance per square inch of sectional area, dependent upon the purpose for which the rope is to be used. The winding drums of flat ropes should be mounted very accurately, so as to prevent "chafing and mounting," and if a rope does not run true it should be tried the other way round, *i.e.*, be turned end for end.

Messrs. A. Rowat & Co., of Glasgow, have a novel construction of flexible flat wire rope which may prove worthy of notice. These ropes are not formed of a series of parallel strands as above referred to, but a number of flattened wire spirals or oval coils, connected together by transverse wire keys. Amongst the advantages claimed, attention is called to the facilities the construction presents for examination and preservation of the wires.

Sometimes flat and round winding ropes are made of

www.libtool.com.cn
conical or tapering section, so as to avoid lifting superfluous weight, but since the introduction of steel wires of high tensile qualities, the advantage so gained is small, the difference of weight being of far less consequence than formerly.

It has been previously stated that round wire ropes of ordinary construction have the component wires of their strands twisted in one direction, whilst the strands forming the rope are closed the opposite way about. This method of formation is common to hemp or fibre roping and cordage, and was doubtless extended to the manufacture of wire cables, because it was originally considered by many a necessary measure in order to keep the rope together, besides allowing a construction which might be effectually spliced. Time and experience has, however, dispelled the value of such opinions, for in 1880 the late Mr. G. Cradock introduced a construction of roping known as "the Lang lay," and in which the wires forming the strands and the strands comprising the rope were all laid in the same direction. This type of rope was exhibited at the Royal Agricultural Show held at Derby in 1881, and subsequently the efficiency of this construction was speedily recognised. Shortly after this date Messrs. J. Fowler & Co., of Leeds, availed themselves of this type of roping for steam ploughing purposes. At the Newcastle Mining Exhibition of 1887 a large number of removed or worn specimens of the type referred to were shown, accompanied by tabulated statistics regarding their performances. Amongst these exhibits were some ropes which had been in constant work for from three to six years, hauling some 3,500,000 tons of coals at speeds varying from five to fifteen miles per hour, over distances up to 220,000 miles. For running or winding purposes this construction of wire rope unquestionably possesses considerable merit. Upon comparing the two illustrations, Figs. 4 and 5

the difference between an ordinary rope and one according to the last-mentioned construction will be readily apparent. In the first engraving it will be noticed that both the wires composing the strands and the strands forming the rope are laid in a right-hand direction, and consequently the component wires follow a dextral spiral axially to the rope. An advantage of this construction is, that a longer continuous surface of any wire is exposed to wear, and the crowns of the strands are less pronounced ; therefore whilst more uniform wear is promoted, the cutting tendency of

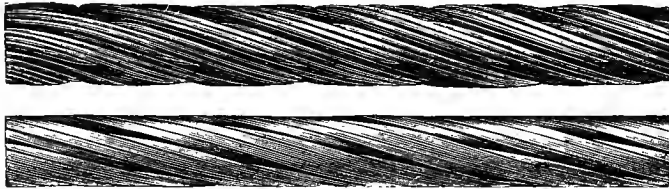

FIG. 4. LANG'S ROPE.

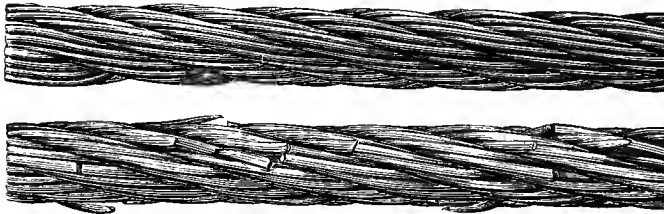

FIG. 5. ORDINARY ROPE

the wires is reduced, and the durability of the rope correspondingly increased. It is further claimed that this construction gives greater strength and flexibility than ropes of the ordinary type, whilst efficient splicing can be equally well effected after a little practice. The well-founded axiom, however, that no particular type of rope can be judiciously advocated for all kinds of work, should always be borne in mind. The following information respecting the manufacture of successful haulage ropes of

useful sizes, made according to the construction last described, will be found instructive :

Approximate Diameter.	Circumference of Rope.	Number of Strands.	Number of Wires in Strands.	Number of Wires in Core.	Gauge of Wires.	Lay of Strands.	Lay of Rope.
in. $0\frac{5}{8}$	in. 2	6	6	1	in. .072	in. $2\frac{1}{4}$	in. 6
1	3	6	6	1	.105	$3\frac{3}{4}$	$7\frac{1}{2}$
$1\frac{1}{4}$	4	6	8	7	.116	$3\frac{3}{4}$	9
2	6.2	6	10	7	.146	$4\frac{3}{4}$	13

Upon analysing this practice it will be noticed that the proportions the lays in the strands and ropes bear to the diameter of the roping range from about three and a half to two and a half and six and a half to nine times the diameters respectively ; *i.e.*, in order to maintain a requisite degree of flexibility the lays are reduced as the sizes of the cables are increased. For standing or fixed ropes the proportions of the lays might be greater. Superior haulage roping of the above construction may be made of cast-steel wires of from, say, 80 to 90-ton quality ; whereas vertical winding ropes might have their component wires of from about 90 to 120-ton strength per square inch, in order to reduce weight ; but it should be remembered that as the tensile strength is raised the hardness of the wire is proportionately increased, and consequently it is less tough and flexible. Sometimes errors of judgment are committed by employing hard qualities of steel, although wires of comparatively high breaking strains may be more safely used in the last-named construction than in ordinary roping, as the lay in the former does not cause such sharp "crowns or knuckles" in the strands.

Ropes of the sizes and construction set forth in the above Table might cost from, say, 40s. to 60s. per cwt., de-

pendent upon the gauge and quality of steel employed in their manufacture. Users of wire roping should not forget the well-founded commercial adage, that cheap or inferior articles are dearest in the end. Plenty of inferior wire ropes are sold annually under conventional and elastic titles, and at prices that good wire cannot be procured for. At present well-tempered crucible cast-steel wire (of, say, about .105 S.W.G.) is worth about £30 per ton; similarly best Siemens-Martin steel wire, about £18 per ton; whilst suitable "homogeneous" or Bessemer steel wire of the same gauge can be obtained at some £10 per ton.

During 1876 Newall introduced a construction of rope in which the strands were laid alternately in reverse directions, *i.e.*, formed of a combination of right and left-handed strands. This arrangement was advocated for preventing the twisting or "spinning" tendency in winding ropes, such as employed for colliery and crane, &c., purposes.

The diagrams, Figs. 6 and 7, represent Laidler's construction of wire rope, consisting in the employment of wires of sectoral configuration. Fig. 6 shows a rope C composed of

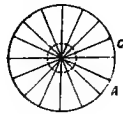

FIG. 6.

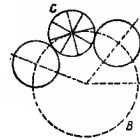

FIG. 7.

wires A, of triangular section, as indicated. Fig. 7 represents the principle as applied to the construction of strands C, for making a rope, the pitch line of which is given at B. This type has been manufactured and sold in some small quantities, but at present its commercial importance appears small, whilst the practical advantages of the construction have not, as yet, been sufficiently demon-

strated. Ropes composed of such sectional wires cannot be neatly spliced, but this drawback also applies to other types in the market.

Mr. F. W. Scott, of the Atlas Rope Works, Reddish, has devised a simple form of "locked" wire rope, and according to this invention two wires of the outer series of the strands or rope are held together by thin strips of metal—preferably steel—turned up at their outer edges, so as to partially embrace the wires and hold them in position. This construction is represented at Fig. 8, in which *a* indicates a pair of wires of an external series, held together by



FIG. 8.

the metallic band *b*, turned up at its edges, as shown. The sets of wires thus secured are then twisted into strands or the outer coverings of roping, and in this manner the external wires are locked or held in their proper relative positions, so that should any become broken they cannot spring out of their normal positions.

From that which has been already explained concerning the construction of ordinary wire roping, or those composed of cylindrical wires, it will be evident that their cores or centres serve as supports for the wires and strands to be laid upon, but that practically they cannot be generally considered as contributing useful tensile strength to ropes. This will be apparent when it is remembered that the strand wires and strands themselves are usually longer than the cores, owing to their spiral turns or construction; and the tensile values of the materials are different.

In 1884 Messrs. Latch & Batchelor obtained letters patent for a novel and ingenious construction, termed "locked coil or stranded ropes." The principle incorporated in this manufacture consists in the employment of various suit-

ably shaped wires, which, when closed together, interlock and present a structure with a uniform wearing surface, in which each component wire is permanently held in its proper normal position. Ropes constructed according to this invention were first publicly exhibited at the Inventions Exhibition held at Kensington in 1885. As before mentioned, the principle of construction may be applied to the production of either locked stranded or locked coil ropes, an example of the latter being represented by the illustration, Fig. 9. This transverse section shows a rope composed of an ordinary wire core around which a series of cylindrical and radial wires are closed, followed by an outside shell of sectional wires which are locked or held

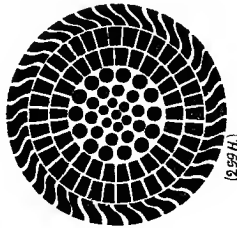

FIG. 9.

down in position. The various succeeding layers of wires are laid in alternate directions, *i.e.*, one to the right hand and the next to the left, and so on as in the manufacture of some compound strands previously referred to. It will be evident that the internal construction, as well as the shape of the external interlocking wires, may be varied or modified to suit different requirements without departing from the essence of the invention, and that the principle may be applied to the formation of one solid rope, as shown, or to strands for making roping on the ordinary method. In the manner above explained, a dense and compact metallic rope may be manufactured presenting an external surface of a smooth and uniform nature like a

cylindrical rod. These ropes may be made of considerable flexibility, and should any of the wires get broken from any cause, they will still be retained in their normal attitudes. In the construction of these or similar ropes, or those composed of compound strands, it is necessary or desirable to vary the lays of the consecutive coils, so that all the component wires may bear their proportionate amount of working strain. Assume the above illustrated coil to be 3 in. in circumference, and the external series of interlocking wires to have a lay or spiral pitch of, say, 5 in., then the requisite lays for the intermediate series or coils may be determined by the construction of the diagram given at Fig. 10. Let A, B, C, and D represent a rectangular

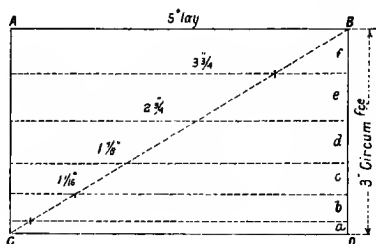

FIG. 10.

parallelogram, the breadth of which is fixed by the predetermined external lay of the rope, whilst its height is similarly governed by the circumference of the rope in question. The diagram is drawn to a scale of 6 in. to a foot for convenience, and the predetermined and deduced dimensions are given in inches. Within the parallelogram defined project a series of parallel lines, *a*, *b*, *c*, *d*, *e*, and *f*—shown dotted—at various distances from the base line *CD*, equal to the circumferences of the different component coils or layers of intermediate wires. Draw the diagonal *BC*. Then, the scaled or measured distances from the perpendicular *AC*, along the parallel dotted lines to the intersections of the diagonal *BC*, represent the proper propor-

tion or lengths of lays for the various component coils. In the diagram, a indicates the core or neutral axis of the rope, b to e —inclusive—the circumferences of the different intermediate coils, and f the external shell of interlocking wires. The proper intervening lays thus deduced are represented on the diagram as $1\frac{1}{8}$ in., $1\frac{7}{8}$ in., $2\frac{3}{4}$ in., and $3\frac{3}{4}$ in. In practice, however, sometimes a rather longer or disproportionate lay is given to the external series of wires, in order that the outside of the rope may bear the greatest strains, and thus first indicate any rupturing tendencies in the wires. Upon considering the solution presented by the foregoing diagram, it will be understood that, owing to the variation of the spiral lays in accordance with the increasing circumference of the contiguous annular series, the same lengths of wire are contained in any given rectilinear or axial length of rope.

It will be evident that roping composed of "sectional wires" cannot be well spliced in the true acceptance of the word, although connections may be effected by brazing, welding, or socketting, or other convenient coupling contrivances. The inside layers of wire, which furnish a large proportion of the rope's strength, according to the construction at issue, are protected from wear: the durability of these ropes may be satisfactory. Their uniformly smooth surfaces should cause less wear to pulleys or drums than those of the ordinary formation. Comparing weights, these locked coiled ropes appear to figure satisfactorily, for according to publications it is recorded that a locked coil rope weighing 6 lb. per fathom broke at 21 tons, whereas an ordinary rope of the same circumference exhibited an ultimate tensile resistance of only 13 tons; an ordinary rope of corresponding strength weighed about 8 lb. per fathom. It is, of course, presumed that the class of steel used in both ropes was of similar grade or quality. These ropes appear suitable for winding

www.libtool.com.cn

and guiding purposes, although the extra first cost may be a consideration to some users, *i.e.*, from 20 per cent. above the price of ordinary roping.

Messrs. Latch & Batchelor have since invented another novel type of wire roping, composed of "flattened" or elliptical strands as represented at Fig. 11. The elongated strands *b* are formed of the wires *f* laid round a metallic

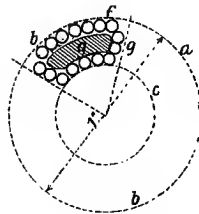

FIG. 11.

core *g*. The chief object of the invention is to provide a construction which will permit of more than one external wire being in peripheral working contact at the same time.

The flattened surfaces of the strands may be obtained in various ways, *e.g.*, by employing flat, oval, or triangular core wires upon which the outer wires are wound.

Amongst the advantages claimed by the inventors are: That more than one wire must at all times be in working contact; that for a considerable distance along the strands a smooth wearing surface is presented; that in consequence of these virtues it is practical to use finer wires in their construction than in ropes of ordinary types, and by which means high degrees of flexibility are obtained. The ropes are compact, and their component wires and strands may all be laid in the same or opposite directions as desired. It is stated that splicing may be neatly and effectually carried out.

Messrs. Newall & Co. have introduced a type of roping under the somewhat pedantic title of "the *ne plus ultra* of ropes," which is composed of strands of parallel wires laid

into rope at one operation, the advantages claimed being that the rope is made in one machine at one operation ; that the component parallel wires of the strands are necessarily of equal length, and therefore bear their equal proportion of working strain ; that the lay in the strands is coincident with the lay of the rope, by which it is stated that " the greatest possible length of wire is exposed to wear."

About two years ago Messrs. Craven & Speeding, of Sunderland, commenced the manufacture of Westgarth's construction of wire ropé. It has been previously explained that during the manufacture of ordinary wire roping the wires composing the strands are usually twisted from two to three times, whilst the strands make one spiral turn, or, in other words, the proportion that the lay in the strands bears to that of the rope is commonly, in round figures, two or three to one ; consequently an allowance is made for the difference of lengths, or resultant absorption, termed in the trade the " uptake " of the strands. According to Mr. Westgarth's invention, the amount of twist or spiral pitch put into the strands in relation to that adopted in the rope is proportioned and regulated with due consideration for the percentage of the uptake in the component strands, and by which the following results are alleged to be obtained : Firstly, the torsional strains exerted upon the wires are reduced ; secondly, the working strains on each wire are in the direction of its plane, and further, that when the rope is bent or deflected over pulleys, &c., the component wires give towards themselves, and not transversely to their axes ; thirdly, that in consequence of their proportionate arrangement of lays or twists these ropes exhibit less tendency to " kink ;" and fourthly, in virtue of the first and second above claimed advantages, the integral wires are rendered capable of wearing to a maximum extent without being so liable to break at the crowns of the strands. The inventor submits that the aggregate

www.libtool.com.cn

frictional surface of the individual component wires depends only on the length and size of the rope, and not on any particular direction or angularity of lay either in the strand or rope. The diagram, Fig. 12, is given to further elucidate the theory of the construction under consideration. Assume ab to represent a length of rope to be manufactured, and ac to be the requisite length of the strands to form such rope, then the dotted arc db subtending the angle a obviously indicates the points of equal length in the strands and rope, whereas the extension of the oblique line or hypotenuse from d to c represents the proportion of strand absorbed by the twisting process, or equivalent uptake. The figures or divisions indicated

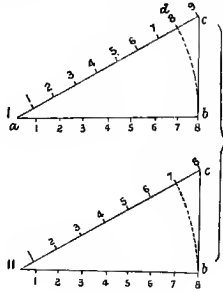

FIG. 12.

upon the hypotenuse and base represent the number of twists in the strands and rope respectively for a given lineal length. It will be noticed that according to the construction of an ordinary rope marked I, a greater number of twists exist in the strands than in the rope, whereas, according to Westgarth's invention—marked II—the number of twists in both cases are the same. It should be here observed that in the Diagram I. all the divisions representing the twists are of equal length, whereas in the second figure the scale of spiral turns is unequal, because both the base and hypotenuse are divided into eight parts as shown, *i.e.*, all radii of the same circle being equal, hence the lengths ab and ac are equal, but in the second example

www.libtool.com.cn
the scale of measurement is extended to the hypotenuse, which exceeds the length of the radius by the distance $d c$. It will be now understood that according to Diagram I, nine twists are shown in the strand and eight in the rope, and this is stated to occasion torsional strains resulting from the non-coincident positions of the lays when the rope is put together. On the other hand, by Westgarth's system of construction the number of twists in the strand and rope are the same, notwithstanding the greater length of the former ; that is to say, a proportion of the uptake is distributed over the lays of the strands so as to make the same coincident with that in the rope. How far these theoretical advantages are or may be corroborated by practice appears a matter of divided opinion.

The principle of manufacture seems founded on a reasonable basis. Westgarth's construction is also applicable to the manufacture of flat ropes. The patentee lays proper stress on the quality of wire to be employed in the production of these ropes, for, after all, this is of the most essential importance.

W. Armstrong, Jun., of the Wingate Grange Colliery, has patented a combined metallic rope and electric cable for mining and other analogous purposes, the manufacture of which has been entrusted to Messrs. D. H. & G. Haggie, of Sunderland. The rope in question is similar to some types of submarine telegraphic cables, only in the case mentioned they are employed for the simultaneous functions of winding, hauling, or guiding, &c., and electrical communicating purposes. Within the central core of any suitably constructed rope, or the strands of the same, insulated conducting wires are provided. According to one practical application, these ropes are used for colliery shaft winding ; and, obviously, it is a convenience and safeguard for the occupants of a mining cage to be able at all times to transmit visible or audible signalling codes to the sur-

face, independently of their position in the shaft. Annually numerous accidents occur in mining shafts which, by some such simple means, might be largely prevented or much mitigated. The average annual fatal accidents which occurred in shafts from 1880 to 1886 is stated to be 664, out of which 174 happened during the journeys up or down the same. These ropes vary from about 4 in. to 5 in. circumference, and some have been made over 300 fathoms in length. Independently of thus having at all times a direct signalling communication with the engine-house in case of emergency, the provision is further useful for shaft repairing.

In principle, the idea of employing electrical conductors within winding ropes is not new, and many years ago such roping was manufactured and tried in Germany, but apparently without permanent success.

Fig. 13 represents a section of Seale's construction of

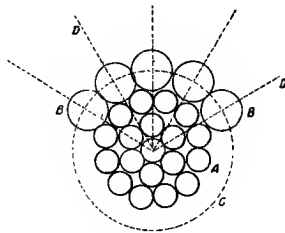

FIG. 13.

wire strand or roping, now finding favour in the United States for tramway traction and other similar purposes. A is intended to represent a compound wire strand or rope, of any convenient form, around which a series of larger wires B are twisted with the same lay, so that the latter shall fit into the spaces or recesses formed by the contiguity of the under series of smaller wires. D indicates the radial centre lines governing the position of the outer series of the strand or wires, whilst C shows the circular pitch-line of the same.

www.libtool.com.cn
This arrangement, it will be seen, secures a very compact and solid construction, particularly suitable for ropes upon which gripping appliances are to be used. The illustration is only intended to convey the principle of construction, and not to give any definite formulæ as to its practical application. Seeing the external series of wires must have the same lay as the internal ones, the working strains cannot be equally distributed throughout the structure, therefore the solidity appears to be obtained at a sacrifice of the theory previously advanced as a scientific desideratum in compound rope constructions. As, however, the outer series are of larger sectional area than the inner wires, this defect may be sufficiently counteracted.

Fig. 14 illustrates Hodson's arrangement of metallic spiral core to allow for the expansion and contraction in wire



FIG. 14.

strands and roping occasioned by bending stresses or elongation, &c. This speciality is manufactured by Messrs. W. J. Glover & Co., St. Helens.

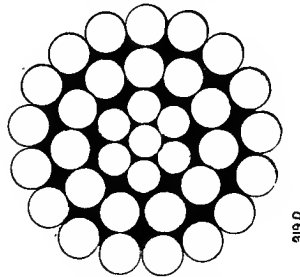

FIG. 15.

Fig. 15 represents a construction much used on the Continent for aerial standing ropes.

www.libtool.com.cn

It may be here appropriately recorded that Messrs. T. and W. Smith, of the St. Lawrence Ropery, Newcastle-on-Tyne, have devoted much careful attention to the matter of properly forming multiple wire strands, and to machinery for carrying such operations scientifically into effect. These ingenious appliances have been constructed by Mr. J. Bulmer, engineer, of the same town, according to the suggestions of Mr. Eustace Smith, of the above-named firm. By the aid of these machines compound strands, composed of a series of wires with increasing lays or spiral pitches, may be simultaneously formed so as to take up the same length of wire in all the strands and the component series of the same. At these works the principle is incorporated in several arrangements and capacities, but for convenience we may confine ourselves to a brief examination of a compound 36-bobbin machine, *i.e.*, a combination comprising 6, 12, and 18-bobbin stranding machines suitably arranged and geared together so as to work in simultaneous harmony. These machines are placed one in advance of the other, upon the same centre line, *i.e.*, in "tandem fashion," so that as a seven-wire strand is spun up in the first one, it is fed as a core into the second machine to be covered with twelve wires, which in its turn is similarly passed on to the third to receive a further coating of eighteen wires.

Thus far the system comprises three separate or independent stranding machines of ordinary construction, of increasing capacities, and may be thus employed, but when used in concert as a serial machine for twisting up layers of wires to form compound strands, all these individual machines are connected up by a suitable train of gearing so as to be simultaneously driven at decreasing or variable velocities, whilst only one "draw-off" drum or motion is used on the last machine. It will be now understood that, by the agency of the train of differential spur-wheels, the first and smallest machine is driven at a maximum speed,

the succeeding ones being actuated in a decreasing proportion. The angular traverse of the draw-off drum bears a uniform relation to the three stranding machines, and thus it will be seen that each apparatus must form a spiral pitch of increasing axial length. The relative or proportionate speeds at which the different machines are driven, in order to obtain certain variations of lays, are previously determined or computed in a similar manner to that already explained with reference to the "locked coil ropes," &c. The component stranding appliances may be driven in alternate or the same direction, so that the series of wires may all be laid up in the same or alternating directions as desired. The speeds or motions of different parts of these machines may be varied at pleasure by the aid of interchangeable spur-gearing. This firm is now manufacturing a type of roping termed "Albert's lay," or in which all the component wires and strands are laid up in the same direction. Messrs. T. & W. Smith have further added to their efficient works a large horizontal closing machine capable of twisting 40 tons of strands in one continuous piece of roping without a tuck or splice. This piece of mechanism was also built by Mr. Bulmer, who has been engaged in the manufacture of cable and rope-making plant for upwards of thirty years.

Window sash-lines are now largely made of copper and steel wires, their circumferences usually ranging between about $\frac{1}{4}$ in. and 1 in., the construction adopted being commonly six strands of seven wires. Gilt and silver, &c., picture cords are similarly manufactured, but their dimensions are obviously much smaller. Galvanised iron and steel wire clothes-lines, formed of strands of five or seven wires, also find an extensive scope of service. Strands of similar construction and material are also largely employed for actuating railway signals, and in the construction of fencing or other like purposes. Copper wire ropes, of from about $\frac{1}{2}$ in.

www.libtool.com.cn
to $\frac{3}{8}$ in. in diameter, now find a wide field of application as lightning conductors, and are preferred by many authorities instead of copper tapes or ribbons of some $1\frac{1}{2}$ in. broad by $\frac{1}{8}$ in. thick. According to the usual practice of rope-making in the United States, six strands of only seven or nineteen wires are employed, and there the safe working loads of wire roping are generally taken to be one-fifth to one-seventh of their ultimate strength, whereas in this country the factors of safety allowed commonly range between one-sixth and one-tenth of their breaking strain. Obviously the margin allowed must vary according to the angle of the plane at which a rope is required to work, the maximum factor being given to ropes working in vertical planes.

We will now turn our attention to some wire rope-making plant of the most modern type. Some few leading rope manufacturers construct their own machines, or rather their duplicates, for with very few exceptions, specialists have designed the original machine to be found in most works, whether at home or abroad. Amongst engineers in this country who have made a special study of wire-working machinery generally and have attained a deservedly good reputation for this class of plant, none are more worthy of recognition than that of Messrs. Barraclough & Co., of Manchester and London. This company has supplied a great number of wire ropemaking and other machines to home and foreign manufacturers, the success of which appear largely attributable to the careful attention bestowed upon details of construction, combined with the use of good materials and workmanship.

Machines built at their works are usually arranged to carry from six to twenty-four bobbins of various sizes, ranging from about 5 in. to 7 ft. in diameter, whilst many of them may be equally well employed for rope-closing as for strand-forming purposes. For the latter functions the six, twelve, and nineteen bobbin machines are now most

used for with the first named the common 7-wire strand can be conveniently produced ; and, when desired, this can be covered with twelve outer wires in the second machine to form the now much-used 19-wire compound strand, or the operations could be equally well performed on the last-mentioned type of machine. This class of strand could also be formed entirely on a 12-bobbin machine. In making larger kinds of rope, *e.g.*, marine hawsers of, say, 366 wires, one 24-bobbin machine might be employed to lay up the various component series as follows : Firstly, six bobbins would be used to form a 7-wire strand, including the core ; secondly, around this twelve outer wires would be laid by employing a corresponding number of bobbins, and so on ; thirdly, the nineteen wires would be encased within eighteen more ; and finally, the thirty-seven wires would be covered with twenty-four, thus making an aggregate of sixty-one wires in each strand. In this manner, and by the one machine, the six strands of a flexible wire hawser of, say, 12 in. in circumference, could be produced with an ultimate breaking strain of about 320 tons, dependent upon the quality of wire employed in the manufacture. Some few types of wire ropes are composed of four, five, and seven, &c., strands, but as the majority are constructed with six strands around a centre core, closing machines of this capacity are usually sufficient for all ordinary requirements.

According to the practice of some manufacturers, and the nature of their machines employed, compound strands are simultaneously formed by spinning up nineteen or more wires at one operation.

The bobbins of ordinary stranding machines may contain from, say, 8 lb. to 800 lb. of wire, of from about No. 20 S.W.G. to No. 5, whilst some large-sized roping machines will close strands about $4\frac{1}{2}$ in. circumference into rope. The space occupied by the former appliances commonly

varies from about 6 ft. 10 in. by 2 ft. to 26 ft. by 6 ft., up to 55 ft. by 10 ft. Stranding and closing machines may be arranged in either a vertical or horizontal position.

With these prefatory remarks concerning the general arrangement and functions of strand and rope-making machinery, we will now proceed to consider some of the latest developments and productions in this department of engineering.

During the past few years, superior steel wire roping in comparatively long lengths has been in considerable demand for many purposes, as obviously it is not practical to splice a wire rope as perfectly as one composed of hemp or vegetable fibres. Spliced portions are usually more or less the thickest and stiffest parts of cables thus united, and therefore if they are required to run over pulleys, drums, &c., the uneven wear and premature deterioration is not infrequently very noticeable. By way of example, ropes for street tramway traction purposes may be cited as a case where great lengths of cable are required as free as possible from splices.

It was, indeed, with this view that Messrs. Cradock & Co., of Wakefield, erected their 30-ton horizontal rope-closing machine, and a similar observation also applies to the big machine provided in Messrs. Bullivant & Co.'s works. The former firm has produced steel wire ropes in their machine for the Melbourne cable tramways of 8300 yards in one continuous piece, weighing 24 tons 13 cwt. As a further result of this comparatively recent demand for long lengths of continuous roping Messrs. Barraclough & Co. not long since constructed the largest rope-closing machine yet built in this country. This colossal piece of mechanism was designed for a firm of rope manufacturers in the United States. The machine is of the vertical type, *i.e.*, the flyers and bobbins are arranged to revolve in a horizontal plane about a vertical axis, and the strand-closing die is fixed to

the longitudinal framing or beams provided above the machine. This arrangement was considered desirable on account of its size and the great weight of wire carried upon the bobbins. The six reels, or bobbins, measure about 7 ft. across their flanges, each being capable of carrying 8 tons of strand, or an aggregate weight representing about 56 tons of roping, including a wire core-strand. The core, however, is not mounted in the machine itself, but is wound from off an outside stationary reel, whence it passes up the centre of the flyer frame in a vertical direction to the closing die.

The bobbin frames, or flyers, are composed of wrought iron, and revolve with the rotary portion of the machine; whilst the former, carried in the same, are always maintained in one attitude, or relation, by means of a sun-and-planet motion, which prevents any axial twisting of the strands. The under-framing, or annular ring, which carries the bobbins and their appendages, is arranged to run on a series of steel balls and peripheral rollers provided within a circular path, and by which the running of the machine is nicely equalised, and only a comparatively small power required for its operation.

The machine is further designed—in respect of the relation that the flyers bear to the floor level—so that the colossal bobbins or strand reels, with their weighty burdens, can be easily rolled by hand into their proper places or respective bearings. The strands are drawn off the six bobbins, through the frames and closing die, by means of a large draw-drum, around which the rope passes several times before it is finally coiled upon a reel, driven by the gearing of the machine. As the coils of strand rotate around the central core, they are drawn upwards together through the fixed closing die by means of the draw-off drum above referred to, the angular velocity of which determines the speed of traction, and consequently the lay of the rope being manufactured; or, in other words, the

spiral pitch of the component strands. The total weight of this machine, excluding the bobbins, is 33 tons, and 8 horsepower is sufficient to drive it, whilst only one man is required to attend its operations. The working velocity of the machine in question varies from, say, twelve to twenty revolutions per minute, dependent upon the weight of strands carried; that is to say, at first, when the bobbins are heavily laden, the machine is driven slowly, otherwise the centrifugal force exerted might break the flyers or injure the machinery. The speed of production naturally depends upon the lay of the rope being manufactured, and the rate at which the apparatus is operated; however, its capacity on an average may be taken to be from 200 to 300 yards per hour.

According to English practice, cable traction ropes, of about $3\frac{1}{2}$ in. in circumference, are commonly constructed with six strands of seven or fifteen wires, the lays in the strands varying from, say, 3 in. to $3\frac{1}{2}$ in., and the lays in the ropes from, say, $7\frac{1}{2}$ in. to 9 in. In the United States, however, strands of nineteen wires are generally preferred as being more flexible; but, on the other hand, the smaller external wires wear out more rapidly. For example, the Market-street Street Railway Company, San Francisco, has used ropes $1\frac{1}{4}$ in. in diameter composed of six strands of nineteen steel wires, weighing $2\frac{1}{2}$ lb. per foot, the longest continuous length being 24,125 ft. Similarly, the Chicago City Railroad Company has employed cables of identical construction, the longest length being 27,700 ft. Again, on the New York and Brooklyn Bridge Cable Railway steel ropes of 11,500 ft. long, containing 114 wires, as above explained, have been used. Further considerations involved in this and other similar classes of wire roping will be resumed later on in this chapter.

Fig. 16 illustrates a very similar kind of vertical closing machine to that just described, with the exception that its

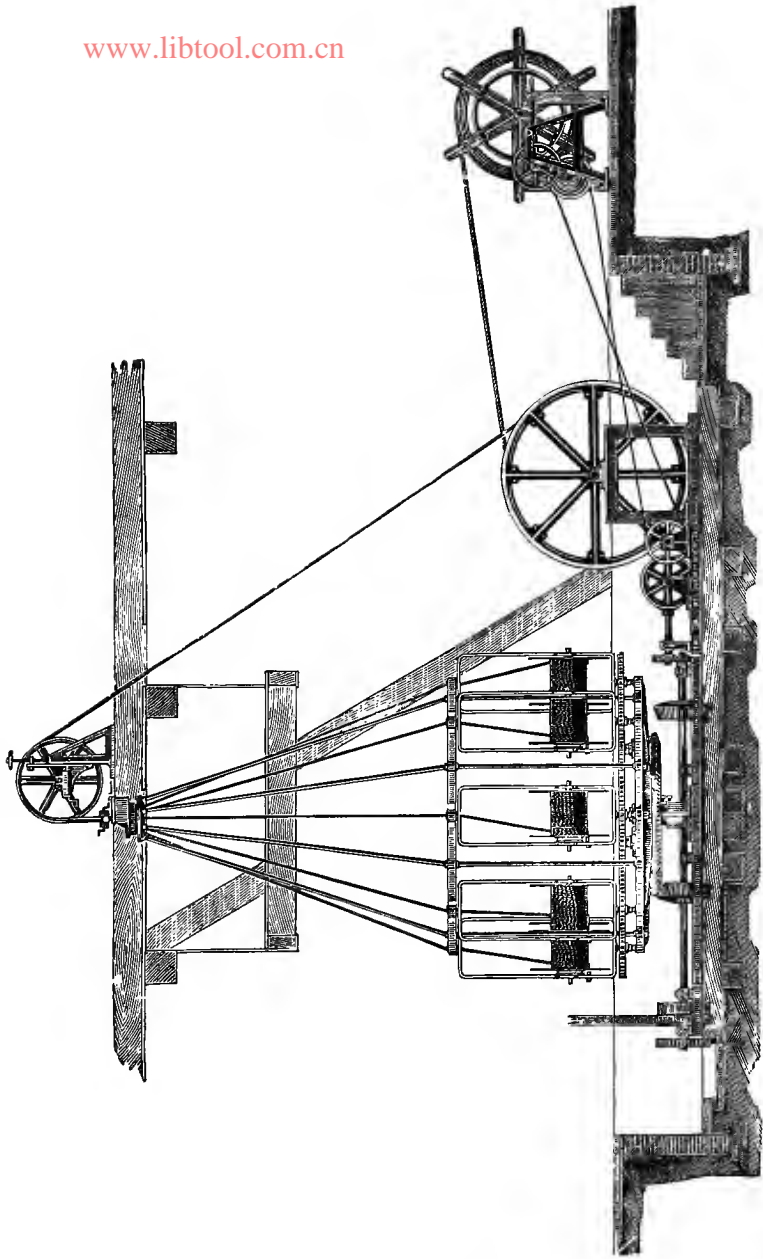

FIG. 16. VERTICAL ROPE-CLOSING MACHINE.

smaller capacity has rendered a few detail modifications advisable.

This class of machine is constructed with 6 to 9-strand bobbins and a central core reel all arranged within suitable "flyer-frames" controlled by a "sun-and-planet motion" as previously explained. The stationary rope-closing die is arranged above the machine, as shown in the engraving, the said mechanism being provided with convenient means of adjustment. The "draw-off drum," represented on the right-hand side of the base of the machine, is operated by an appropriate train of gearing, the speed of which may be varied at pleasure by means of interchangeable pinion wheels.

From that which has been previously written concerning the general functions of rope-making machinery, it will be now readily understood how the strands carried by the revolving bobbins are drawn off and closed by the fixed die, through the agency of the draw drum. As the finished rope leaves the drum it is coiled upon a reel mechanically operated as shown in the illustration.

A 12-bobbin horizontal stranding machine constructed by Messrs. Barraclough & Co., is represented at Fig. 17, but as the principles of construction and operation embodied in the same are similar to others already described, it will only be necessary to point out the existence of some special details peculiar to this company's design.

The spindle bearings provided in the flyers of this machine are formed of replaceable malleable iron bushes, the supporting rollers of the revolving portion of the mechanism being provided with convenient means of adjustment, whilst the wrought-iron cranks of the flyer motion are secured by keys as well as pins. The front end of the horizontal (bored) shaft is carried upon anti-friction rollers arranged in the headstock of the machine. A special arrangement of gearing is further provided for actuating the coiling reel, and a

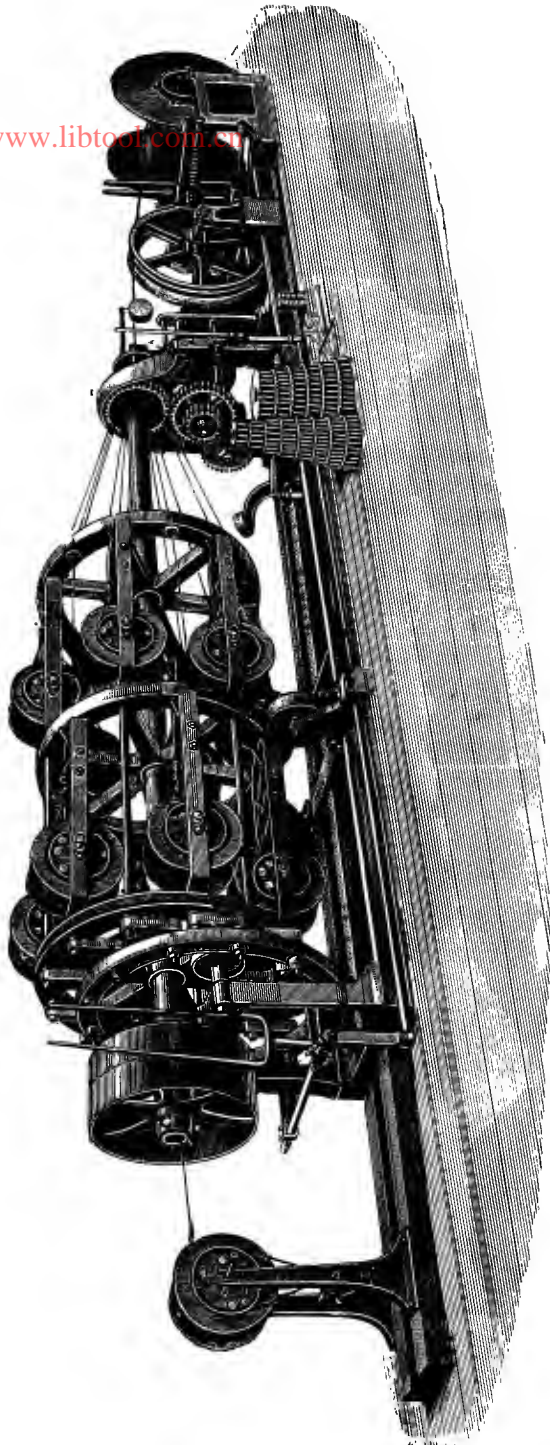

Fig. 17. 12-BOBBIN STRANDING MACHINE.

www.libtool.com.cn

metallic belt brake is fitted to the annular framing of the revolving portion of the machine. The bobbins are 14 in. in diameter, and each hold about 140 lb. of wire. This machine may also be employed for closing strands into roping up to about 3 in. in circumference.

It may be here mentioned that continuous strands of any convenient lengths may be produced in any machine by tucking, brazing, or welding on additional wires; *i.e.*, when a skein or coil of wire on any bobbin is worked off another may be introduced, the end of the last wire in the strand being brazed or soldered on to the one end of the fresh coil, and so on; the various bobbins may be replenished with wire to practically any extent. In fact, the only limit is the capacity of the largest closing machine capable of receiving the strands and twisting them into ropes. It may be also pointed out that both stranding and closing machines are usually capable of being driven in either a right or left-handed direction, at the option of the manufacturer; but, ordinarily, strands are twisted up to the left hand, whilst rope is closed to the right. Reverting to Messrs. Barraclough's big closing machine previously described, it will be now understood, that as tramway traction ropes may average about $3\frac{1}{2}$ in. in circumference, and weigh some $4\frac{1}{2}$ tons to the mile, this machine is capable of producing roping of, say, over ten miles in one continuous piece. When, however, it is desired to manufacture heavier cables, such as required for towing or other marine and exceptional mining purposes, the apparatus is equal to the demand, as the closing die or lay plate may be readily adjusted to produce the thickest ropes yet prescribed. It is well known and generally admitted that coils of galvanised and other wire can be shipped at very moderate rates, as such bundles can be easily handled and stowed at small risk, whilst coils of rope weighing, say, 20 to 40 tons each are difficult and costly to handle, and consequently are

subject to high freights, landing dues, and transporting charges. With the present facilities for conveying and putting down machinery in most parts of the world, the manufacture of large ropes by the consumers themselves is now quite practicable.

The increasing demand for long lengths of continuous wire roping free from splices, for hauling, winding, and other purposes, has given rise to other ingenious manufacturing devices, amongst which a Canadian invention termed "a compound wire cable making machine," is worthy of notice. The illustration, Fig. 18, on the folding plate, represents a machine of this construction as manufactured by Messrs. Barraclough & Co. This mechanical contrivance carries forty-two separate bobbins of wire, and is capable of making the strands and rope of, say, a 3-in. cable, in one operation to any convenient length. Upon reference to the engraving, it will be understood that the bobbins at the rear of the apparatus hold the strand cores, whilst the two succeeding series carry the strand wires, which, when spun up, are closed into rope by the lay plate or closing die fixed to the bedplate of the machine. The strands pass over guide rollers, and become concentrated at the head-stock, and closed into rope at the die plate, whence it is drawn off by the drum, driven by appropriate gearing, as previously described. The central core, or heart of the rope, is shown entering at the back of the machine, through the tubular shaft. It will be now understood that the series of forty-two bobbins, or coils of wire (with the strand cores), enable six strands of seven wires each being simultaneously formed and closed into roping. The machine is driven by suitable pulleys and spur gearing, as represented. The core and strand bobbins, as also the guide rollers above mentioned, are mounted around the hollow horizontal shaft by which they receive their differential rotary motion, the bobbins being maintained

www.libtool.com.cn

Missing Page

www.libtool.com.cn

in suitable relative positions by means of the sun-and-planet motion and gearing, so as to avoid twisting the individual wires forming the strands and rope. The closing dies are capable of suitable adjustment so as to accommodate the gauge of wire used and size of rope to be produced, the lays adopted in the strands or rope being also capable of suitable variation, according to requirements. The rope is passed four or five times round the draw drum, driven by gearing at the requisite peripheral velocity to give the required lay, the motion being communicated to the same by means of a horizontal shaft running under the machine. Upon leaving this drum the rope passes between a pair of "jockey," or compressing rollers, which serve to keep it taut, whilst an ingenious arrangement of mechanism is attached to the delivery-gear, so as to automatically indicate the exact length of rope manufactured in the machine. The entire component mechanism is so constructed and arranged that all the motions of the machine can be reversed, *i.e.*, so as to allow of the wires being laid in one direction and the rope closed in the opposite way, or the wires and strands may be all twisted in the same direction. The adjustable strands and rope dies are arranged to exert an elastic pressure by means of spiral springs. The machine, it will be seen, incorporates two distinct functions and motions, *i.e.*, each of the stranding devices has an independent rotating motion to form the strands, whilst the entire apparatus revolves around the horizontal shaft for closing the same into rope. The wires forming the strands are independently conducted into their proper spiral paths in order to obtain the requisite solidity and flexibility. The machine is capable of manufacturing ropes composed of strands containing any number of wires up to nineteen.

The Hartlepool Ropery Company has adopted a similar

www.libtool.com.cn

class of plant under the term of "a patent non-torsional rope-making machine," and by which, it is stated, that wires are laid into strands and roping free from all torsional influences, the metallic filaments being caused to take their proper positions and parallel attitudes to the spiral. As in the machine already described, the process of making the strands and rope is simultaneously performed in the one appliance.

The lays adopted in roping are mainly dependent upon the gauges of the wires employed, the sizes of ropes to be made, and the purposes to which they are to be applied; and as a general approximation it may be stated that the lays in strands vary from about 2 in. to 6 in., or say about three to four times the diameter of the rope; whilst the lays in roping range from about 6 in. to 12 in., or say seven to ten times their diameter: in other words, about two to three twists are put in the strands to one in the rope. It should, however, be understood that these proportions will necessarily vary according to the sizes of the ropes, and whether they are intended for fixed or running purposes. Short-laid ropes are more flexible than those in which a comparatively long lay is adopted. Hence short lays are frequently desirable for hauling and winding, whilst, conversely, long lays are usually beneficial in standing ropes. Black or clean drawn wire is generally used for the construction of running ropes, whilst galvanised roping may be advantageously employed for some purposes, *e.g.*, ships' rigging, and marine hawsers, &c., or for ropes working in water or wet places.

According to Messrs. J. Roebling & Sons' opinion, black wire ropes may be preserved under water or ground by the application of vegetable or mineral tar, to which some fresh slacked lime has been added to neutralise acidity. This firm also considers that "in no case should galvanised ropes be used for running purposes. One day's use often scrapes off the coating of zinc, and then rusting proceeds with twice

the rapidity upon the exposed surfaces." The writer, however, has seen a galvanised steel rope, $3\frac{3}{4}$ in. in circumference, employed in a Staffordshire coal mine that had worked day and night for four years, and in which period it had raised 2,600,000 tons of mineral. In America running ropes are usually composed of six strands of nineteen wires, whilst standing ropes are constructed of six strands of seven wires. The wires in the strands are usually united by brazed lap joints. Steel employed in the manufacture of wire ropes should be of the best or superior qualities, as low grades may give inferior results to good iron wire.

Reverting to compound strand and rope-making machinery, last year the writer had the opportunity of examining a very analogous machine to that last described, at the engine-house of the Market-street Cable Railway Company, San Francisco, Cal. The machine in question was, however, arranged to work in a vertical instead of a horizontal position, but the results at this time appeared to be decidedly indifferent, for the strands were irregular and "kinked," whilst the closing mechanism was chafing their crowns to a marked extent.

Returning to examine the vertical rope-closing machine illustrated at Fig. 16, it will be noticed that the strand bobbins are of considerable diameter but of limited breadth, a measure essential to insure easy angles of delivery to the closing die. In some similar machines employed in the United States such precautions, however, appear disregarded, for strand bobbins of considerable breadth (like hawser reels) are mounted, in some cases (without flyers), upon rotary tables, consequently the angles of delivery are comparatively sharp and variable.

Of late years the demand for flexible wire ropes, or cables composed of a large number of wires, has greatly increased, and therefore special attention has been bestowed upon strand-making machinery suitable for their manufacture.

Fig. 19 on the folding plate, represents an ingenious class of machine, constructed by Messrs. Barraclough & Co., for meeting such requirements, and that which may be appropriately described as a "compound tandem stranding machine." It will be observed that it consists of four independent stranding appliances arranged one before the other on the same horizontal axis, and to which one draw-off motion is provided. The bobbins, in the example illustrated, each hold about 370 lb. of wire, the machine being capable of making strands up to sixty-one wires, in the following manner: Commencing from the left-hand side of the diagram, the wire or hempen core is drawn through the tubular shaft of the first machine to receive a covering of six wires; this strand is then drawn in as a core to the second machine, where it is coated with twelve more wires, and so on to the third and fourth, to be spun over with eighteen and twenty-four wires respectively, thus forming the finished compound strand of sixty-one component wires. As the strand leaves the last portion of the machine, it passes three or four times around the "draw-through drum," from whence it is coiled upon a reel ready for being made into rope. The four stranding devices are all geared together so as to be driven at decreasing speeds dependent upon the lays required, the course of rotation being in alternate or the same direction according to the type of strand desired to be manufactured. It will be apparent that as only one draw-off motion is provided, the strand must have the same rate of lineal progression through the four differential rotary machines, therefore by changing the angular velocities of the drum or motion referred to, uniform proportions of "lays" or spiral pitches will be produced. The machine is well designed and of strong construction. The central hollow shafts which carry the annular frames are formed of steel, the latter being provided with gun-metal flyer bearings. The cranks are of machined wrought iron

secured by keys and pins. The flyers are constructed of the best forged iron, and are fitted with improved bobbin tension apparatus. The machine is mounted upon anti-frictional bearings as described with reference to the 12-bobbin stranding machine. The stopping and starting mechanism runs the whole length of the machine so that one attendant may have perfect control of the same. The draw-off drum is provided with a "surging" or smooth periphery equipped with a divider capable of variation according to the requirements of the user.

The reeling apparatus is double geared so as to allow for the varying diameter of the coil, and is constructed either with a horizontal or vertical shaft.

A "jockey pulley" may be affixed to the draw drum when required. The machine works on a series of cast-iron bedplates, carefully machined and fitted together, so as to form a compact and reliable job, whilst anti-frictional runners are placed under some of the rings in order to reduce the vibration and to enable the machine to travel at a maximum speed. These runners are fixed in suitable frames provided with adjustable staying apparatus to compensate for the wear of the brasses.

The concentrating or rose plates and dies are of an improved construction, the die holders travelling on double stays, whilst pressure is applied to the dies either by a lever and weight or by springs, according to the requirements or desire of the manufacturer. Messrs. Barraclough & Co. also manufacture various types of wire-drawing, testing, and straightening, &c., machinery, of the classes described in an early stage of this treatise.

Some of the machines employed in the construction of "locked coil ropes" previously described, are provided with some fifty or more bobbins, for it will be apparent that their number will be dependent upon the quantity of wires used in the annular series. In this case the manu-

www.libtool.com.cn
facture of the ropes is effected after the manner of forming a compound strand as already explained with reference to other machines. Mr. John Bulmer has made a speciality of this and other classes of rope-making plant.

It will be readily understood that wires of fancy sections are drawn precisely similar to those of cylindrical form, the apertures in the draw-plates being varied according to the configuration required. Wires of irregular sections are, however, more costly to produce, and their manufacture is usually confined to comparatively mild qualities of steel.

It has been explained with reference to several types of strand and rope-making machines, that great care is usually exercised to provide efficient mechanical devices for preventing any twisting of the component wires or strands. We will now direct brief attention to an American machine which has been recently introduced to the notice of manufacturers in this country, in which the above specified precautions are intentionally disregarded.

The contrivance in question is the invention of J. B. Stone, of Worcester, Mass., and is illustrated in side sectional elevation and plan at Figs. 20 and 21 respectively. The inventor claims to "do away with the necessity of preventing torsion being put into the individual wires or tendency to kink in the strands," &c., by the use of an analagous arrangement to that employed in Archibald Smith's obsolete machinery, combined with a wire-straightening device such as described on page 92 of this volume. How the patentee effectually dispenses with this necessity above referred to, does not, however, appear so clear, for it is one matter to straighten wire with twists in it, and another to prevent or remove them.

Reverting to the illustration, A is an ordinary horizontal flyer frame, mounted in suitable bearings, and within which the wire or strand bobbins B are arranged about the spindle *b*. Those acquainted with A. Smith's old

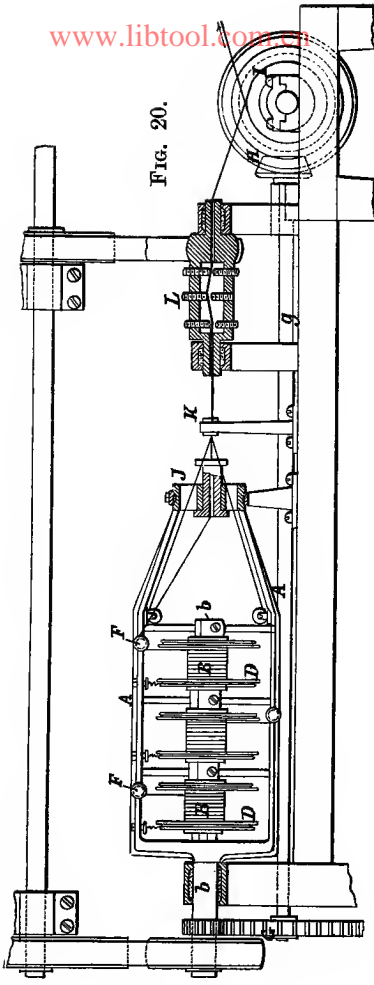

FIG. 20.

FIG. 22.

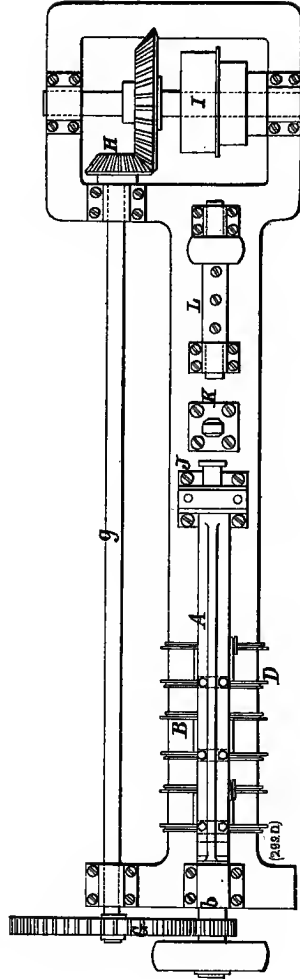
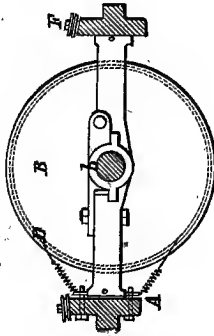

FIG. 21.

STONE'S WIRE ROPE-MAKING MACHINE.

www.libtool.com.cn machines, will at once recognise the similarity in this part of the design. D are tension cords or belts for controlling the "pay off" of the bobbins, whilst F are small pulleys mounted upon the revolving framing for governing the direction of the wire or strands delivered to the closing die. These details will be better understood by reference to Fig. 22, which represents a detached sectional view to an enlarged scale. This portion of the machine is actuated by the shaft *g*, provided with spur-gearing G, and bevil pinions H, as shown in the plan. J is the core and wire-concentrating tube, and K the fixed closing die. L is the wire straightener such as that already described with reference to Fig. 24 before mentioned. I represents the draw-off gear. The bobbin-flyer and the straightening device are driven by pulleys and straps communicating with a counter-shaft as shown in the first figure. These illustrations are taken from the specification of the British patent, and which doubtless are only intended to convey the principle of the invention, for it is not clear as to what usual descriptions of strands or roping could be made with three bobbins as shown, although distinct reference is made to such manufactures, *e.g.* :

"I have discovered that, by passing a rope made of two or more individual wires twisted together, without reference to the torsion put into the wires in the process of twisting them together, or without any means employed for preventing torsion being put into the wires as they are twisted together, through what is termed a straightening device, of any ordinary construction and operation, by giving alternate bends to the wire or wires passing through it, all tendency of the rope to kink and contort is removed."

"Briefly, my invention consists in twisting together two or more wires, and then passing the twisted wires through a straightening device, or a device adapted to give alternate bends to the wires, for the purpose of removing the ten-

dency to kink and contort therefrom, all in one continuous operation," &c.

The number of bobbins is, however, immaterial for our purpose, and we will assume the rotary flyer A to contain any suitable number of bobbins, the core being conducted through the centre of the tube J, whilst the wires or strands are similarly passed through the periphery of the same to the stationary closing die K. When a sufficient length has been pulled forward, the strand or rope is taken through the straightening apparatus L to the draw-off drum I, and the machine is then set in motion. It will now be apparent that as the flyer revolves with its bobbins the wires or strands concentrated at J will be twisted into a strand or rope at the fixed die K, and then be drawn forward by the drum I through the straightener L, so as to remove kinks or sinuosities. The last-mentioned appliance is not, however, pretended to remove torsion put into the wires or strands caused by the variable relation of the bobbins, and, therefore, upon the whole, the writer fails to appreciate the value of the following remarks in the specification, viz.:

"The great advantage of my invention will be readily appreciated by those skilled in the art, for, by doing away with the necessity of employing mechanical means for preventing torsion being put into each individual wire in the process of twisting the several wires together to form the rope, I am enabled to greatly increase the speed of the machine for twisting the wires together, and thus increase the amount of production."

The machine in question may answer sufficiently well for running up some common descriptions of strands and roping, *e.g.*, for fencing and rigging purposes, but most of our manufacturers would hardly care to employ one for the production of superior steel ropes of comparatively high tensile efficiencies.

Although there unquestionably exists a large scope for

technical knowledge and dexterous manipulation in the manufacture of wire generally, one can scarcely claim the wire rope-making industry to reasonably constitute a very learned or high art in modern structures. Certainly a manufacturer should exercise considerable judgment in the selection of his wire, besides the choice of constructions suitable for different applications; but the employment of efficient machinery and dealings with a good and reliable wiredrawer is fully half the way to a successful issue. Unfortunately, keen competition, combined with the inconsistently cheap requirements of many consumers, have in some cases necessitated manufacturers resorting to the use of materials frequently against their wishes and experiences.

Some engineers and customers would probably often get better results by leaving their rope specifications to manufacturers or other experienced persons practically versed in the properties of wire and cable constructions, for not infrequently impracticable requirements are inserted, and sometimes inconsistent details insisted upon. However interpreted, such specifications must sometimes lead to the production of unsatisfactory ropes.

Mr. A. S. Biggart's paper on "Wire Ropes," recently read before the Institution of Civil Engineers (Vol. CI. of the Proceedings), certainly constitutes one of the most valuable contributions yet published in connection with the industry at issue. Mr. Biggart was one of the engineers associated with the erection of the celebrated Forth Bridge, and the experiments described in the paper in question were undertaken with the object of determining some practical means of guidance in the selection of wire ropes to be employed at these works. The importance of these investigations will be appreciated when it is understood that over sixty miles of such roping were engaged in the erection of this colossal structure. Beyond the usual considerations of

external wear, careful attention has been devoted to the results caused by internal friction, and the fatigue of steel wires from working over small pulleys such as used in cranes or hoisting appliances. The ropes employed for such purposes had to be composed of numerous wires of small diameters, in order to obtain sufficient flexibility to withstand the severe bending stresses. About two years ago the writer received a communication from the author expressing the opinion that the failure of crane ropes was frequently due to the smallness of the pulleys over which they had to work, backed by the experience that sometimes he had observed cases in which three-fourths of their ultimate strength were taxed by the bending strains alone. In the execution of the works at issue rigid ropes were only used for wind-ties; the flexible ropes ranged from $1\frac{3}{4}$ in. to $2\frac{3}{4}$ in. in circumference, and were composed of crucible steel wires about .036 in. in diameter. Their construction was chiefly six strands of twelve, nineteen, or twenty-four wires, weighing about 2 lb. to 4 lb. per fathom, and presenting ultimate breaking strains of from about $6\frac{1}{2}$ tons to 10 and 15 tons. The tensile efficiencies of the steel wires supplied ranged between 70 and 100 tons per square inch of sectional area, but the averages were from 80 to 90-ton quality. Mr. Biggart found that the strength of the component wires individually considered was about 10 per cent. above that obtained when in the form of roping. Further, the variation in the strength of pieces of plain wire was ascertained to be about 8 per cent., whilst galvanised wire showed a fluctuation of only 3 per cent.; but in torsional efficiency the former withstood an average of some ninety twists in 8 in., whilst the latter attained an average of sixty turns and no appreciable difference was detected, whether the twists were effected slowly or with considerable rapidity. Upon consulting the Tables appended to this paper it will be

observed that the loss of ductility in annealed galvanised wire is very pronounced, whilst an increment in such property is exhibited in the case of annealed plain wire, *e.g.*, the galvanised wire withstood 57 twists against 178 in the plain condition. The loss of tensile strength due to annealing was found to be about constant in both cases. The permanent set observed in different qualities of steel wire varied between 25 and 80 per cent. of their ultimate tenacity, *i.e.*, the former in mild Bessemer, and the latter in superior qualities of cast-steel wire. A similar range of elasticity is pointed out in Chapter I. (Section I.) of this volume. The average extent of elongation noticed in crucible steel wires is recorded as being about 3 per cent. Mr. Biggart points out that if a length of wire rope be soldered or secured at its ends the rigidity of the specimen is greatly augmented, and that the resistance may approach that of a solid bar. This is almost self-evident, and many will be aware that it is detrimental and deceptive to submit samples of flexible ropes to customers which have been secured at their ends by rings or other binding devices. The value of frictional adhesion present in roping, from the contact of the component wires, is exemplified in this paper by the fact that a splice of about 40 ft. in length may exert a resistance equivalent to the ultimate strength of the rope. This supports the experiments and views of the writer, who has also observed a similar result upon testing a rope which has had all its component wires cut some 18 in. in advance of one another. Biggart's investigations further show that the practice of allowing a diameter in pulleys of fully six times the circumference of the rope required to work over the same is beyond usual requirements, although the sizes of the component wires should not be disregarded. The pulleys, in the case at issue, over which the ropes were tested, were of $10\frac{1}{2}$ in. and 17 in. in diameter, but the results showed a marked increase

of durability in the rope as the sizes were increased; the cutting tendency produced by the longitudinal or axial movement of the component wires entered largely into these determinations. The author found that a rope $1\frac{3}{4}$ in. in circumference ran over the first-named size of pulley 16,000 times with a load equal to one-tenth of its breaking strain before there were any fractures or serious deteriorations. Subsequent examinations were considered to support the contention that the destruction of the ropes was more due to internal cutting friction and fatigue of the steel than from any external wear. This cutting action was found to be materially mitigated by the application of oil or other lubricants, when capable of permeating the rope. Thus, for example, a similar piece of roping to that which withstood 16,000 bends, when oiled ran 38,700 times over the same pulley before breaking. Other similar pieces of rope unoiled ran over a 24-in. pulley 74,000 times, and when lubricated 386,000 times. The better bearing surface afforded to the wires of running ropes when laid according to "Langs' system" is well supported by the fact that ropes of this type under similar conditions made 53,000 and 107,600 passes over the $10\frac{1}{2}$ -in. pulley before fracturing.

This last experiment strongly upholds the contention long since propounded by the writer, viz., that for wire ropes employed for running round or over pulleys, the component wires and strands should all be laid in the same direction, although the date is not very distant when supposed authorities ridiculed the idea of such a construction.

Some three years ago the writer also called repeated attention, in different articles, to the baneful effect of running ropes round pulleys in reverse directions, *e.g.*, used in some mining shafts and rope-driving machinery, &c.; Mr. Biggart's experiences go to show that generally the life of a rope is twice as long when only bent in one

www.libtool.com.cn
direction as against those used under alternate stresses of flexure. The depreciation in the properties of wire when made up into roping appears further supported by the author's tests of bending efficiency, in which the wires individually considered showed a far greater working life.

If this loss is apparent in carefully manufactured ropes what amount of sacrifice might one reasonably expect to find in those produced by indifferent machinery, in which torsional and bending influences, &c., are disregarded? In the experiments under consideration, excellent results were obtained by the employment of Bessemer iron and mild qualities of steel wires, and which did not reveal the symptoms of fatigue so discernible in higher grades of steel.

In conclusion Mr. Biggart is of opinion that flexible wire crane ropes should usually be made of ungalvanised steel wires of about 80 tons quality with oiled hempen cores to form both the cores of the strands and central hearts, whilst the component wires and strands should all be laid in the same direction. Further, the ropes when in use should be frequently lubricated, both for reducing external wear and internal friction.

Although there are doubtless some small discrepancies in the paper just discussed, such as some disregard of the element of time, trivial inaccuracies as to the sizes of certain wires to produce ropes of stated circumferences, and references made to an obsolete and meaningless standard, such as B. W. G., &c., it is on the whole a most important and valuable contribution to the literature on the subject.

In Deakin's paper on "Wire Ropes," recently read before the South Wales Institution of Engineers, some interesting and instructive particulars were given by the author and subsequent criticisers. Mr. Deakin gives the following depths at which the weights of wire ropes composed of different materials equal their working loads, according to the Table of weights and ultimate strengths accepted by him

viz.: Charcoal iron, 850 yards; Bessemer steel, 925 yards; patented cast steel, 1400 yards; plough steel, 2000 yards. The author advocates the allowance of factors of safety from $\frac{1}{8}$ th to $\frac{1}{10}$ th of the maximum loads the ropes will withstand, and expresses an opinion in favour of ropes composed of six strands of seven, eight, or nine wires all laid up in the same direction, with cores of annealed iron wires. Proper stress is laid upon the value of lubricants and preservatives against rust, as well as that of storing ropes in dry places, and the desirability of uncoiling ropes from off reels so as to prevent the liability of injury from kinking. The sizes of pulleys and drums herein advocated are about ten times the circumference of the ropes to be used on the same, or say 1 ft. in the diameter of the former for each pound of rope per fathom, *e.g.*, a drum $3\frac{1}{2}$ ft. in diameter for a rope weighing $3\frac{1}{2}$ lb. per fathom.

The value of keeping proper rope records was strongly upheld, *e.g.*, makers' name, quality, type of construction, when put to work, miles travelled, speed of work, tons hauled, and when discarded, &c.

During the discussion, in which many leading mining engineers and other authorities took part, the following reasonable contentions were advanced. Wire ropes composed of ordinary cylindrical wires, laid in the same direction as their strands, found the strongest and most unanimous support, whilst those formed of wires of fancy sections, such as in Laidler's construction or the "lock-coiled ropes, obtained on the whole few practical admirers or advocates. The Westgarth system was considered by several to consist largely in theoretical allegations, the advantages claimed not being appreciable in practice. Many complaints were raised by users concerning the great irregularity in the quality and durability of ropes, and an instance was cited in which the sizes of wire in a rope varied some .006 in. and their tensile values from 34 tons to

214 *Reasonable Weights & Breaking Strains of Ropes.*

54 tons and 65 tons to 80 tons per square inch of section. A discussion then arose as to the reliability of certain tables of strengths of different iron and steel round ropes as supplied by some manufacturers, and which resulted in a favourable reception being given to Messrs. T. & W. Smith's tabulation (here appended), which is certainly consistent

Sizes.		Weights per Fathom.		Breaking Strains.		
Circumference.	Diameter.	Hemp Main Heart.	Wire Main Heart.	Bessemer Steel or Charcoal Iron.	Best Patent Improved Steel.	Best Patent Plough Steel.
in.	in.	lb.	lb.	tons.	tons.	tons.
1	.318	.945	1.12	1.39	2.78	3.81
1 $\frac{1}{4}$.397	1.48	1.74	2.17	4.35	5.96
1 $\frac{3}{8}$.477	2.13	2.5	3.12	6.28	8.58
1 $\frac{1}{2}$.557	2.9	3.41	4.25	8.52	11.6
2	.636	3.79	4.45	5.58	11.1	15.2
2 $\frac{1}{4}$.716	4.8	5.65	7	14.1	19.3
2 $\frac{3}{8}$.795	5.91	6.99	8.7	17.4	23.8
2 $\frac{1}{2}$.875	7.15	8.4	10.5	21	28.7
3	.954	8.5	10	12.5	25.1	34.3
3 $\frac{1}{4}$	1.03	10	11.8	14.7	29.4	40
3 $\frac{3}{8}$	1.11	11.6	13.6	17	34.1	46.6
3 $\frac{1}{2}$	1.19	13.3	15.7	19.5	39.2	53.5
4	1.27	15.1	17.8	22.2	44.5	61
4 $\frac{1}{4}$	1.35	17.1	20.1	25.1	50	68.9
4 $\frac{3}{8}$	1.43	19.2	22.6	28.1	56.2	77
4 $\frac{1}{2}$	1.51	21.4	25.1	31.4	63	86
5	1.59	23.6	27.7	34.6	69.6	95
5 $\frac{1}{4}$	1.67	26.1	30.7	38.4	76.9	105
5 $\frac{3}{8}$	1.75	28.6	33.6	42	84	115.1
5 $\frac{1}{2}$	1.83	31.2	36.8	46	92	126
6	1.9	34	40	50	100	137.5

in respect of sizes and strengths. Improved or patented steel wire of 80-ton quality, with a torsional efficiency of some thirty-five to forty-five twists in 8 in., however, met with the best approval for the construction of mining ropes.

All the component wires of any one rope should have as nearly as possible the same values of tensile efficiency, whilst their connections in the strands should be neatly formed by

brazing or welding. All such joints should be filed up by hand, or by means of an emery wheel, so as to be of the same sectional area as the rest of the wire.

Having determined the construction of any six-stranded rope to be made, the gauge of wires requisite to produce a desired circumference of rope may be roughly ascertained by dividing the required diameter of rope by the number of outside wires to be employed in any strand + 3. This method of computation obviously gives the theoretical diameter of wire requisite to produce a rope of a predetermined size, but in practice the nearest corresponding commercial gauge has to be adopted. It will be further understood that the number of wires employed in each strand, and consequently the gauges of the same, should be varied according to the purposes to which the rope is to be applied. Some manufacturers adopt a rule of making the compound wires of most running ropes of not more than the $\frac{1}{1000}$ th part of the diameter of the smallest pulley over which they have to work ; but the largest gauge employed in patent cast-steel wire seldom exceeds .116 in.

Whilst inspecting some traction ropes in the United States, the writer was surprised to find spiral joints existing in the wires of the strands, something similar to "Britannia jointing" in telegraph wire, which gave rise to rigid irregularities of a very objectionable character. It is fair to remark that these ropes were not made by Eastern manufacturers. It is strange that our transatlantic friends have not yet found the advantages of using the "Lang" construction of wire roping for traction, winding, and general running purposes. Their difficulties in the way of its adoption are apparently connected with the splicing of this type of rope, but it should be remembered that it has been long since extensively used for mining endless haulage systems in Europe, besides on the cable lines of Australia and New Zealand. The length of splices

should, however, be rather longer than those used for ordinary roping in which the wires and strands are laid in opposite directions.

“Multiple laid ropes,” *i.e.*, those composed of six compound rope strands formed with a hempen heart and cores, may be of a very flexible character, and for this reason they are somewhat extensively used on the Continent for hawsers and crane or hoisting purposes. The construction is similar to that already defined as “cable laid,” with the exception that the former usually contains a greater number of wires, *e.g.*, from 700 to 800 wires in a rope from $3\frac{3}{4}$ in. to $7\frac{3}{4}$ in. in circumference. This type of roping is, however, costly, and little adopted in our course of practice.

Messrs. T. & W. Smith have earned a high reputation for the manufacture of flexible crane and lift, &c., ropes, some particulars of which are here appended.

The Table on the opposite page only relates to ungalvanised plough steel ropes; it will, however, be understood that this class of roping can be manufactured from different qualities of plain or galvanised iron and steel wire. The construction usually comprises six strands of seven, nineteen, or twenty-four wires.

From statistics given in Chapter III. it will be evident that comparatively little wire roping is now imported into the United States, indeed the manufacturers are quite capable of meeting the demands and requirements of their customers without any outside assistance. A considerable quantity of superior patent tempered wire is, however, still imported. Some time ago, when cable traction obtained a firm footing in the States, many European manufacturers tried to procure a share of the rope trade, indeed some orders were placed abroad, but apparently with little benefit to the makers or users. When the writer was in Kansas City last year he was informed that some benevolent English

manufacturer had offered a cable tramway company there to deliver at the railway depôt a "coopered" spool of high-class steel traction roping at 11 cents per pound. This

Flexible.					Special Flexible.				
Size.		Weight per Fathom.	Breaking Strain.	Minimum Diameter of Barrel.	Size.		Weight per Fathom.	Breaking Strain.	Minimum Diameter of Barrel.
Circumference.	Diameter.				Circumference.	Diameter.			
in.	in.	lb.	tons.	in.	in.	lb.	tons.	in.	
1	.318	.95	4.2	2	1	.318	.95	4.2	1.5
1.125	.358	1.2	5.3	2.5	1.125	.358	1.2	5.3	1.9
1.25	.397	1.5	6.5	3.1	1.25	.397	1.5	6.5	2.35
1.375	.487	1.8	8	3.8	1.375	.437	1.8	8	2.85
1.5	.477	2.1	9.5	4.5	1.5	.477	2.1	9.5	3.4
1.625	.517	2.5	11.7	5.3	1.625	.517	2.5	11.7	3.96
1.75	.557	2.9	12.75	6.1	1.75	.557	2.9	12.75	4.6
1.875	.596	3.3	14.75	7	1.875	.596	3.3	14.75	5.3
2	.636	3.8	16.75	8	2	.636	3.8	16.75	6
2.125	.676	4.3	19	9.1	2.125	.676	4.3	19	6.8
2.25	.716	4.8	21.25	10	2.25	.716	4.8	21.25	7.6
2.375	.755	5.3	23.5	11.2	2.375	.755	5.3	23.5	8.4
2.5	.795	5.9	26	12.4	2.5	.795	5.9	26	9.4
2.625	.835	6.5	29	13.7	2.625	.835	6.5	29	10.4
2.75	.875	7.2	31.5	15	2.75	.875	7.2	31.5	11.3
2.875	.915	7.8	34.5	16.4	2.875	.915	7.8	34.5	12.3
3	.954	8.5	38	18	3	.954	8.5	38	13.5
3.25	1.03	9.8	44	21	3.25	1.03	9.8	44	15.8
3.5	1.11	11.5	51	24.5	3.5	1.11	11.5	51	18.4
3.75	1.19	13.2	59	28	3.75	1.19	13.2	59	21
4	1.27	15	67	32	4	1.27	15	67	24
4.25	1.35	17	75	36	4.25	1.35	17	75	27
4.5	1.43	19	85	40.5	4.5	1.43	19	85	30.5
4.75	1.51	21	94	45	4.75	1.51	21	94	34
5	1.59	23.5	105	50	5	1.59	23.5	105	34.75
5.25	1.67	26	115	55	5.25	1.67	26	115	41.3
5.5	1.75	28.5	125	60	5.5	1.75	28.5	125	45.2
5.75	1.83	31	137	66	5.75	1.83	31	137	49.5
6	1.9	34	150	72	6	1.9	34	150	54

price, delivered New York, would scarcely leave a margin for a home invoice value of £30 per ton, whereas the most cutting competitors were offering 3½-in. patent steel wire

roping of 180-ton quality, delivered New York, and duty paid, at 12 cents per pound. As our American friends could not quite appreciate the quality of European roping they were likely to get delivered to them in the Western States for so modest a price, the offer was disregarded. Home manufacturers must not overlook the fact that the price lists of their contemporaries in the States are usually subject to 33 per cent. discount, and if necessary sometimes up to 50 per cent. American wire rope manufacturers are supposed to abide by the regulations of a convention. The writer has, however, known transactions which do not support their observance, but as all the manufacturers "pool" their takings and afterwards divide the revenue according to estimated proportions of trade, such discrepancies may be of little consequence amongst themselves. Anyhow, American ropemakers have long since been prepared to deliver good qualities of traction ropes to any part of the States for 12 cents per pound, and at the same time to afford their customers unparalleled advantages in the way of transporting, repairing, and keeping stock on their premises, &c. Only last year the writer saw a contract that had been entered into between a big tramway company and a leading firm of manufacturers, in which the latter undertook to deliver roping to the Western States for nominally 12 cents per pound; the invoices were, however, subject to a discount of 1 cent per pound, besides a further allowance of another cent per pound for the ropes when worn-out. Manufacturers on this side of the "silver streak" will do well to devote their attention to other outlets for their productions.

The following list, incorporating the leading wire rope manufacturers in the United States of America may be of interest to some readers :

Messrs. Roeblings, Sons & Co., Trenton, N.J.
The Trenton Iron Co., Trenton, N.J.

The Hazard Manufacturing Co., Wilkesbarre, Pa.

Washburn, Moen & Co., Worcester, Mass.

The Williamsport Ropery Co., Williamsport.

Broderick & Bascom, St. Louis.

Leschen & Sons, St. Louis.

The California Wire Rope Works, San Francisco.

The manufacturers in this country are legion, but many of them constitute small concerns when compared with the above-named American firms; the principal makers at home, however, have been more or less referred to in the current chapter. The keen state of competition which has existed for some years past between wire rope manufacturers, both in this country and abroad, has given rise to a system of guaranteeing ropes to do a certain minimum service, and receiving payment accordingly. Such an arrangement doubtless suits consumers admirably, but considering the prices commonly obtainable it must frequently prove a losing or starvation game for manufacturers. Price is the main consideration of the day, and in the export market it is by no means of rare occurrence to see a maker of reputation passed over for the difference of 6d. per cwt. Reverting to the case cited of American rope contracts for nominally 12 cents per pound, it may be here further pointed out that the nett 10 cents receivable was subject to a satisfactory performance of 60,000 miles, or the payment was to be proportionately reduced, the manufacturer undertaking to protect the consumer against any claims for infringements, &c. The date of this contract was March, 1889, and relates to dealings with one of the largest cable tramway companies in the States. The remunerative prospects of the manufacturer do not appear very encouraging, for the average life of street traction ropes has certainly not exceeded 40,000 miles.

The proprietors of some Japanese coal mines a short time ago were indulging in the privilege of obtaining ropes from a European manufacturer of ultra-distinction, but

presently the representative of an American firm was invited to the collieries, and who at once appreciated the inferior character of their performances. The result was an offer to furnish some ropes at the same price they had been paying, and an undertaking that they should exceed the lives of those previously purchased, or no payment would be required.

The proposition was business-like but bold, and had the desired effect; trial orders were given, and the ropes turned out as guaranteed, *i.e.*, very superior to those previously supplied, consequently future requirements have been placed in America.

The rope account of the Melbourne Cable Tramways Company is worth something like £15,000 to £20,000 per annum, and the company conducts its business upon very similar lines to those above mentioned. Aspirants for orders have to pass through the ordeal of the Collin-street line, *i.e.*, cables have to give six months of satisfactory service on this section before the full contract price is allowed, *i.e.*, about £40 per ton. Such precautions appear very reasonable, otherwise, they might not only receive inferior manufactures, but be constantly bothered with solicitations and idle assurances.

Occasionally manufacturers are to be met with who possess the unenviable disposition of advocating their own wares by underrating those of their contemporaries. Not very long since one of such grandiloquent individuals made plausible overtures to a colonial cable-traction company, with the result that specimens of ropes previously employed by them were forwarded for his examination and opinions. As might have been expected, everything was wrong; the wires were inferior and the materials unsuitable, whilst the types of construction adopted were obviously unfit for the requirements, &c. The confiding directors were thereby induced to give a trial order;

MESSRS. BULLIVANT & CO.'S TABLE OF ROUND WIRE ROPES.

Sizes of Ropes, and Approximate Weights per Fathom.			Breaking Strains and Equivalent Sizes and Weights of Ropes.							
Circumference of Rope in Inches.	Weight of Rope made entirely of Wire per Fathom in Pounds.	Weight of Rope made with Hemp Centre Core per Fathom in Pounds.	Circumference of Compound Rope in Inches.							Calculated Breaking Strains of Ropes.
			Best Selected "Extra Plough" Steel Wire.	Best Selected "Plough" Steel Wire.	Best Selected Improved Patent Crucible Steel Wire.	Patent Crucible Steel Wire.	Best Selected Bessemer Steel Wire.	Best Selected Charcoal Iron Wire.	Breaking Strain in Tons.	
..	6½	6½	150
6¾	48	42	6	6¾	6¾	139
6¾	44	38	5¾	6¼	6¾	6¾	128
6¼	40	35	5¾	6	6¾	118
6	37	32	5	5¾	6	110
5¾	34	29	4¾	5¾	5¾	100
5¾	30	26	4¾	5	5¾	93
5¼	27	24	4¾	..	5¾	88
5	25½	23	4¼	..	5	85
4¾	24	22	4¼	..	5	80
4¾	22	20	4	75
4¼	19½	17½	4	65
4	18½	16	4	60
..	58
3¾	18½	15¾	3¾	55
3¾	17	14¾	3¾	52
3¾	15½	13¾	3¾	50
3¾	13¾	11¾	3¾	49
3¾	12	10¾	3¾	46
3¾	10¾	9	3¾	41
3¾	10	8¾	3	38
3	9½	8	3	36
2¾	8½	7¾	2¾	34
2¾	8	7	2¾	33
2¾	7	6¼	2¾	32
2¾	6	5½	2¾	31
2¾	5½	5	2¾	30
2¾	4¾	4¼	2¾	29
2¾	4¾	4	2¾	27
2	4	3¾	2	25
1¾	3¾	3¾	1¾	23
1¾	3	3	1¾	22
1¾	..	2¾	1¾	21
1¾	..	2¾	1¾	20
1¾	..	2¼	1¾	19
1¾	..	2¼	1¾	18
1¾	..	2¼	1¾	17
1¾	..	2¼	1¾	16
1	..	1¾	1	15
1	..	1¾	1	14
¾	..	1¾	¾	13
..	..	1¾	¾	12
..	..	1¾	¾	11
..	..	1¾	¾	10
..	..	1¾	¾	9
..	..	1¾	¾	8½
..	..	1¾	¾	8
..	..	1¾	¾	7½
..	..	1¾	¾	7
..	..	1¾	¾	6½
..	..	1¾	¾	6
..	..	1¾	¾	5½
..	..	1¾	¾	5
..	..	1¾	¾	4½
..	..	1¾	¾	4
..	..	1¾	¾	3
..	..	1¾	¾	2½
..	..	1¾	¾	2
..	..	1¾	¾	1½

Sheaves and barrels should be about 30 times the circumference of the ropes used.

MEMO.—For shaft-winding at a high speed, one-tenth of the breaking strain of a rope is sometimes taken as fair working load. For inclines the proportion of load to breaking strain varies according to gradient conditions, and friction should be allowed for.

www.libtool.com.cn

but when the rope arrived and was put to work, it speedily proved to be amongst the very worst they had ever been supplied with.

During the open competitions in Australia, ropes manufactured by Messrs. Cradock & Co., T. & W. Smith, and Roebling, &c., have apparently achieved the best records.

When on a visit to the goldfields of Victoria the writer was impressed with the number of mining operators that still adhered to the use of hempen ropes; in Europe the Belgians were amongst the latest to employ metallic roping.

Should a federation of colonial interests be ultimately arrived at in Australia, doubtless some wire-working factories will be soon started there. India can boast of two small wire rope works on the Hooghly, although most superior kinds of roping are imported.

It has been previously mentioned that sometimes manufacturers have to contend with very inconsistent specifications, a mild example of which may be cited as follows: Some two years ago our manufacturers received invitations to tender for some steel traction ropes $3\frac{1}{2}$ in. in circumference, "to be composed of 114 wires of 95-ton quality, capable of withstanding fifty-five twists in 8 in., with 2 per cent. of elongation, &c." The request was practically ignored by leading makers, but fortunately a manufacturing friend of the specifier is stated to have turned up with the desirable material.

CHAPTER VI.

SOME APPLICATIONS OF WIRE ROPES.

IN this chapter it is proposed to place before the reader a few typical illustrations of the many serviceable applications of wire roping, and with such object some mining and other engineering operations, in which metallic ropes fulfil important functions of utility, will now be described.

About three years ago the writer published in the columns of "Engineering" a report upon the various systems of "underground haulage" as then shown at the Newcastle Mining Exhibition. As records of these unique exhibits cover, in a concise form, most practices still observed in this country up to date, it is believed their substance is worthy of reproduction.

Few of the various systems and contrivances then shown, however, possessed much novelty; on the contrary, in principle they embodied most of the features known or used in mining industries from fifteen to thirty years ago; but numerous ingenious devices were shown in the way of details, which repaid careful examination. Probably the advantages of some of the special arrangements of haulage that were exhibited may have been recognised and adopted. There appears, however, room for more uniform principles in the practice of underground wire rope haulage, although it is at once evident that no one system of working is capable of universal application, owing to the variable conditions presented in mining, and perhaps more especially in colliery, operations.

www.libtool.com.cn

To those interested in the application of rope haulage to the propulsion of street and other vehicles, the exhibits in question were also highly instructive, embodying, as they did, the principles and essential details of the modern cable tramway system, which have been used in mining operations for over the past quarter of a century.

It will be known to many readers that in 1867 a report was published by a committee formed by the North of England Mining Institute, upon the various systems then in use for the underground transportation of coal; this report terminated with the opinion that in most cases the endless chain system would be found the most economical, the endless rope system came next, the tail-rope method being placed last on the list. It is, however, difficult to understand how a more or less cumbersome and heavy chain can prove the best medium for hauling tubs or trucks, and subsequent experience has shown that the conclusion referred to has been rather refuted than confirmed.

The chain may possess facilities for attaching and detaching the tubs, but at present, when wire ropes can be manufactured of one-sixth the weight of an ordinary chain with the same strength, a considerable amount of power must be wasted by employing the latter. Besides, a rope can be more easily handled, and, being a compound structure, its outer wires show indications of weakness or wear, whereas a chain may suddenly part at any link without warning. Dispensing with ground pulleys—as in the chain system—appears a doubtful advantage when it requires that tubs (full or empty) shall be kept running at suitable intervals to carry the chain, thereby involving a certain depreciation of rolling stock. The plan of supporting the chains upon the tubs may lighten the load on the hauling engines, but this advantage should be more marked in similar systems using ropes than in those with chains. Considering the difficulties arising in working curved lines by

such methods, little, if any, balance appears to remain in the favour of this point. Further, working by endless chains generally necessitates a special preparation of the way, with rising and falling planes to run the tubs on and off—an arrangement involving some expense and often much inconvenience. It is true, however, that statistics of working expenses have been published, which tend to support the utility and economy of the endless chain, but calculated working costs of haulage systems in collieries are sometimes misleading or inaccurate, as not infrequently the conditions are so different and variable that trustworthy comparisons and conclusions are difficult to arrive at.

In the committee's report before referred to, the approximate total costs of working by the three systems, in the cases investigated by them, are given as follows :

By the endless chain system	1.3d. per ton per mile.
„ „ rope „	2.5d. „ „
„ tail-rope system	1.8d. „ „

When, however, we examine the widely-varying conditions under which the respective systems were working, *e.g.*, differences of speed, curves, gradients, length of lines, loads, the amount and nature of distribution, variable arrangements of engines and plant, we may readily understand how difficult it must have been to arrive at any decision of a thoroughly reliable nature.

Upon examining the detailed items which compose these total working expenditures the cost of the endless chain itself is given as .083d. per ton per mile as against about .260d. for rope. Similarly the labour accounts are given as .572d. per ton per mile and 1.600d. respectively. Referring to the tail-rope system, it was found that the endless rope worked rather more economically with regard to the rope account. It is true that these investigations were made over twenty years ago, but on the other hand this report is still largely referred to, and was almost the only accessible

authority on the subject. Passing on to more recent examples of the performances of the endless rope, we find rather better results to record in its favour; thus the calculated total working cost of the endless rope system for underground haulage at the Clifton Collieries, Nottingham, is given as about 1.6d. per ton per mile, out of which 1.1d. is consumed by wages. At the Cadzow Colliery, N.B., the total actual cost of working by the endless rope system is given as 1.7d. per ton per mile, whilst the Tredegar Iron and Coal Company have recorded performances with the endless rope as low as 1.1d. and 1.3d. per ton per mile. These three are examples of average conditions and work, as all systems of haulage will show varying working costs dependent upon the nature of the conditions under which they are called upon to operate, as also the amount of work to be performed. To-day the employment of haulage chains is fast dying out, and at no distant date their use will be probably recognised as obsolete.

We will now return to consider the various systems of rope haulage that were shown at Newcastle, assisted by reference to the general plan given on page 228, and upon which the names of the different systems are printed, as well as their general characteristics. The exhibits may be divided into three classes, viz. :

1. Endless rope systems.
2. Endless chain systems.
3. Main and tail-rope systems.

The endless rope system consists in the employment of a continuous or united rope, arranged to travel up one line and down another (or over a single line and passing places) upon supporting pulleys or tubs, and around terminal sheaves, to one of which the driving motion is communicated. The rope is driven at a speed of about two to four miles per hour, and the tubs or wagons are commonly attached to, and released from it, by means of clip hooks,

grips, or equivalent devices. In some cases the tubs are arranged separately and at convenient intervals along the rope, in others they are attached in groups. An up-and-down track, or a road with sidings, is usually provided for working by this system, the one for accommodating the full, and the other for the return of the empty tubs, to the workings of the mine. According to the systems that were shown by the Tredegar Company, Hodbarrow, Whitburn, Harton, Castle Eden, Eldon, and Moresby, the ropes were carried under the tubs, whereas in the Seaton Delaval Company's and Bedlington Company's methods the endless haulage ropes were carried at the side and top of the tubs respectively. The Tredegar and Moresby Companies showed their systems of endless rope haulage as applied to the working of single lines with passing places, whilst the Harton Coal Company illustrated the same system applied to a special type of permanent way termed the "three-rail system." The Hebburn Colliery Company illustrated an application of the endless chain, which is practically similar to the endless rope system of haulage just explained. The Hetton Coal Company exhibited the "main and tail-rope system," which consists in the employment of two separate ropes attached to independent operating drums; the main rope, which lies on pulleys between the rails of a single track, is used to haul the full sets of tubs out of the workings, whilst the tail rope is subsequently employed to pull the empty tubs back from the shaft to the workings. Sometimes from 80 to 100 full tubs, containing about 7 cwt. to 8 cwt. of coal each, are simultaneously hauled out in a train, with a tail rope attached, which is usually from half to three-quarters the diameter of the main rope. Only a single line of way is required to work according to this system of haulage, and in some cases the sets are hauled a distance exceeding two miles from the workings to the shafts, at a speed of from ten to twelve

M O R F E T H R O A D

Approximate distance 500 Ft. **Fig. 1.**

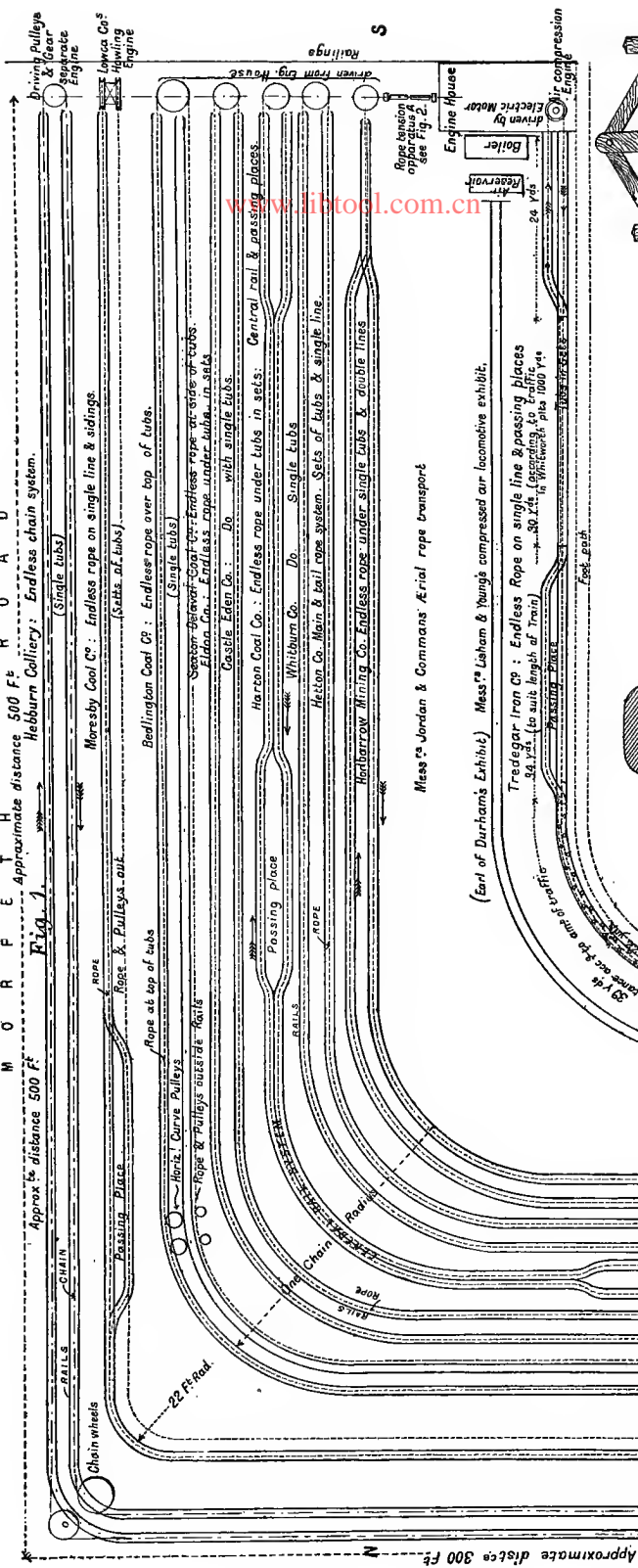

(Single tubs)

Moresby Coal Co.: Endless rope on single line & sidings.
(Sets of tubs).

Bedlington Coal Co.: Endless rope over top of tubs.
(Single tubs)

Seaton Delaval Coal Co.: Endless rope at side of tubs.
Eldon Co.: Endless rope under tubs in sets.

Castle Eden Co.: Do with single tubs.

Harton Coal Co.: Endless rope under tubs in sets: Central rail & passing places.

Whithorn Co.: Do Single tubs

Harton Co. Main & tail rope system. Sets of tubs & single line.

Hobbarrow Mining Co. Endless ropes under single tubs & double lines

Messrs Jordan & Commins: Aerial rope transport

(Earl of Durham's Exhibit) Messrs Lisham & Young's compressed air locomotive exhibit.

Tredegar Iron Co.: Endless Rope on single line & passing places
34 yds. to suit length of Train

39 yds. to suit length of Train
34 yds. to suit length of Train
39 yds. to suit length of Train
34 yds. to suit length of Train

39 yds. to suit length of Train
34 yds. to suit length of Train
39 yds. to suit length of Train
34 yds. to suit length of Train

39 yds. to suit length of Train
34 yds. to suit length of Train
39 yds. to suit length of Train
34 yds. to suit length of Train

39 yds. to suit length of Train
34 yds. to suit length of Train
39 yds. to suit length of Train
34 yds. to suit length of Train

39 yds. to suit length of Train
34 yds. to suit length of Train
39 yds. to suit length of Train
34 yds. to suit length of Train

39 yds. to suit length of Train
34 yds. to suit length of Train
39 yds. to suit length of Train
34 yds. to suit length of Train

39 yds. to suit length of Train
34 yds. to suit length of Train
39 yds. to suit length of Train
34 yds. to suit length of Train

39 yds. to suit length of Train
34 yds. to suit length of Train
39 yds. to suit length of Train
34 yds. to suit length of Train

39 yds. to suit length of Train
34 yds. to suit length of Train
39 yds. to suit length of Train
34 yds. to suit length of Train

39 yds. to suit length of Train
34 yds. to suit length of Train
39 yds. to suit length of Train
34 yds. to suit length of Train

39 yds. to suit length of Train
34 yds. to suit length of Train
39 yds. to suit length of Train
34 yds. to suit length of Train

39 yds. to suit length of Train
34 yds. to suit length of Train
39 yds. to suit length of Train
34 yds. to suit length of Train

39 yds. to suit length of Train
34 yds. to suit length of Train
39 yds. to suit length of Train
34 yds. to suit length of Train

39 yds. to suit length of Train
34 yds. to suit length of Train
39 yds. to suit length of Train
34 yds. to suit length of Train

39 yds. to suit length of Train
34 yds. to suit length of Train
39 yds. to suit length of Train
34 yds. to suit length of Train

39 yds. to suit length of Train
34 yds. to suit length of Train
39 yds. to suit length of Train
34 yds. to suit length of Train

39 yds. to suit length of Train
34 yds. to suit length of Train
39 yds. to suit length of Train
34 yds. to suit length of Train

39 yds. to suit length of Train
34 yds. to suit length of Train
39 yds. to suit length of Train
34 yds. to suit length of Train

39 yds. to suit length of Train
34 yds. to suit length of Train
39 yds. to suit length of Train
34 yds. to suit length of Train

39 yds. to suit length of Train
34 yds. to suit length of Train
39 yds. to suit length of Train
34 yds. to suit length of Train

39 yds. to suit length of Train
34 yds. to suit length of Train
39 yds. to suit length of Train
34 yds. to suit length of Train

39 yds. to suit length of Train
34 yds. to suit length of Train
39 yds. to suit length of Train
34 yds. to suit length of Train

39 yds. to suit length of Train
34 yds. to suit length of Train
39 yds. to suit length of Train
34 yds. to suit length of Train

39 yds. to suit length of Train
34 yds. to suit length of Train
39 yds. to suit length of Train
34 yds. to suit length of Train

39 yds. to suit length of Train
34 yds. to suit length of Train
39 yds. to suit length of Train
34 yds. to suit length of Train

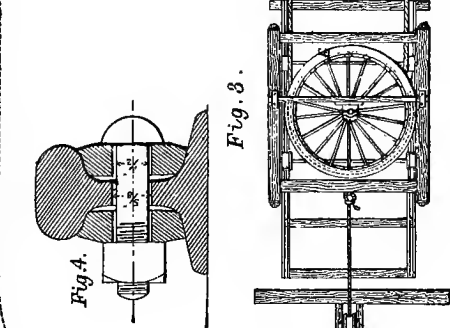
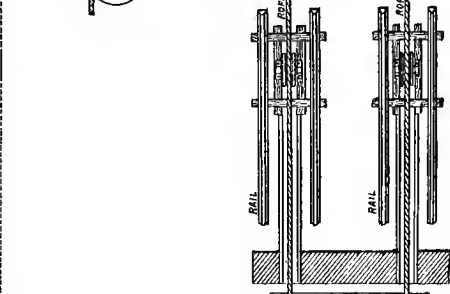
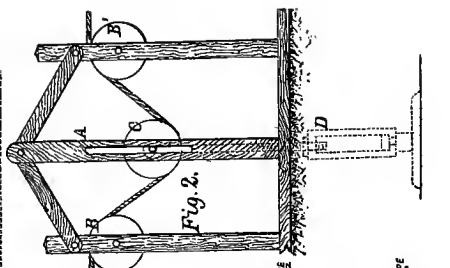

Terminal tension pulleys & carriages
E: See Fig. 3.

SYSTEMS OF ROPE HAULAGE EMPLOYED IN MINES.

miles an hour. The old Blackwall rope railway of 1840 was worked on a very similar system, but at that date little was known about the manufacture of wire ropes; besides, trainloads of about 200 tons were hauled on this railway at a speed of about twenty-five miles per hour, which appears excessive for even a modern arrangement of rope railway.

We will now proceed to more closely examine the salient features and details of the various systems to which we have referred. It will be seen from the plan, Fig. 1, that the various systems were arranged to operate over a distance of about 800 ft., but after running some 500 ft. in a straight direction the tracks were deflected, in order to judge of their comparative efficiency in dealing with curves. The Moresby Coal Company's system was shown working round a curve of about 22 ft. radius, whilst the remainder had a uniform radius of about one chain. The Tredegar Company's system was operated by an electric motor; the Hebburn and Moresby exhibits were actuated by two small independent engines, whilst the others were driven by steam motors of horizontal types.

The systems, which required the ropes to be driven in alternate or opposite directions, were actuated by means of driving pulleys, whilst those which only required the ropes to run in the same direction were chiefly operated by means of Fisher & Walker's tapering pulleys, fitted with their ingenious friction clutch gear. The driving ropes were maintained taut by passing through the tension apparatus A, shown in Fig. 2, and consisting of an adjustable pulley C and two fixed pulleys B, B', mounted in a suitable framing. Upon lowering the pulley C in its slotted frame by means of the screw D, it will be readily understood that any reasonable slack in a driving rope can be taken up and the requisite tension obtained. This rope, as a matter of convenience, passed from the vertical and main

www.libtool.com.cn

operating drum fixed upon the engine shaft, to a series of horizontal driving pulleys, which actuated the various systems, each of which were provided with clutches for throwing any particular section in or out of gear. The various haulage ropes were maintained in a requisite degree of tension by passing round terminal tension sheaves *E* (see Fig. 3) mounted upon travelling carriages held back by means of the counterweights *F*. In cases where the haulage ropes were arranged to operate below the tubs these tension sheaves were placed at the ground level or below the surface in pits, but in the cases of the Bedlington and Seaton Delaval systems, in which the ropes were carried at the top or side of the tubs, the appliances were raised upon convenient stagings so as to place them in suitable planes. In some

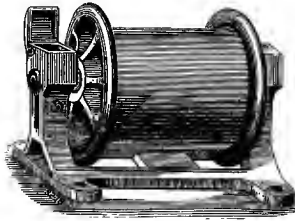

FIG. 5.

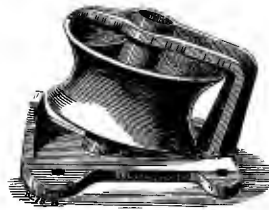

FIG. 6.

instances right and left-handed tension screws were provided instead of the counterweights *F*. The permanent ways were chiefly composed of 24-lb. flanged steel rails as shown in Fig. 4, a type of rail much used in the mining districts of Northumberland, Durham, and Yorkshire. These rails were fished and spiked to transverse wooden or metal sleepers with gauges varying from 2 ft. to 2 ft. 6 in. The haulage ropes were arranged to run on ground rollers or pulleys of about 6 in. to 8 in. in diameter as shown at Figs. 5 and 6, with the exception of those systems in which the ropes or chains were carried by the tubs or wagons. The types of pulleys shown for accommodating the haulage ropes—mounted below the tubs—are examples of

Hadfield's cast-steel rollers, a speciality to which this firm has devoted much attention with marked success. Fig. 5 illustrates a design suitable for accommodating haulage ropes upon straight lines, whilst Fig. 6 shows an arrangement of pulley for controlling the ropes at curved portions of lines. These cast-steel pulleys are very light and durable, and are now rapidly superseding those composed of cast iron. The hardness of the material does not appear to appreciably shorten the lives of ropes if the pulleys be properly mounted, lubricated, and attended to, and steel pulleys will last in working order for from six to twelve times as long as those of cast iron. At the Clifton Colliery steel pulleys have been in daily service for over five years, and still the results are eminently satisfactory, some of their ropes having achieved working lives of over four years.

Figs. 7 and 7A illustrate a side elevation and sectional plan respectively of Messrs. Fisher & Walker's friction clutch driving drum, an arrangement previously referred to as being largely used for operating haulage ropes.

The rope is wound round the slightly tapering drum so as to obtain the requisite driving adhesion. A truly turned metallic disc H is keyed to the driving shaft, and around it a steel segmental belt I is arranged to work so as to embrace or release the disc. The operation is effected by means of the right and left-handed screw bolts J operated by the lever appendages K connected to the crossbar L, having a central tubular boss free to slide upon the main shaft. The driving drum is mounted free upon the shaft or prime mover, but is connected with the segmental belt I by means of pins. It will be understood that when it is desired to throw the driving drum and rope out of gear, the crossbar L is moved axially upon the shaft by means of appropriate hand gear, thereby turning the screw bolts J, so as to cause the segmental belt I to release the

www.libtool.com.cn
 keyed disc H. By moving the crossbar in the opposite direction the metallic belt is caused to again grasp the disc, when the whole apparatus revolves bodily. It will be

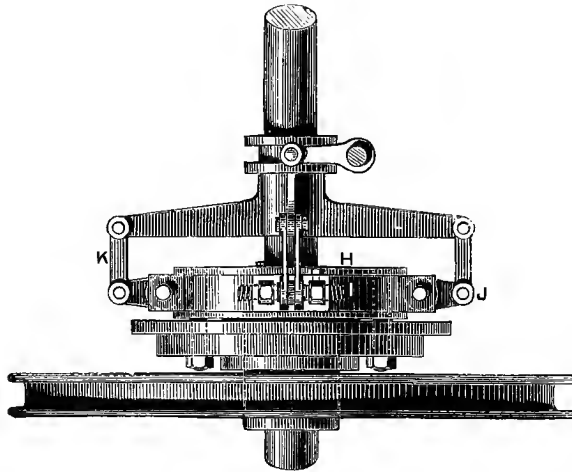

FIG. 7.

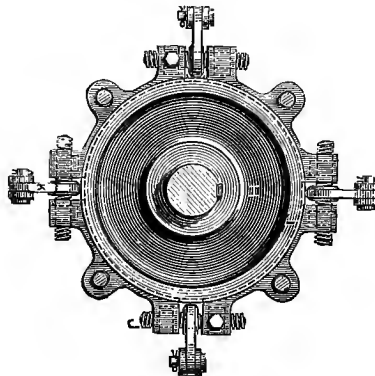

FIG. 7A.

further seen that in the event of any sudden or excessive strain being thrown upon the ropes or working parts, the clutch belt will slip, and thus prevent breakages or undue

straining of the machinery. In this manner, should any tubs get thrown off a line, or other obstruction arise, the sudden increase of resistance upon the haulage ropes will cause the clutch to slip, and thus the driving drum and rope are allowed to rest whilst the shaft continues to idly revolve. By the employment of such or similar contrivances much damage to rolling stock and permanent way is frequently avoided. The requisite frictional adhesion for driving is obtained by taking one or more turns round the drum with the rope in the same direction, and thus strains of contraflexure are avoided. The drum being slightly tapered the coils or turns of rope work nicely down it, and the in-coming portion always runs clear upon the upper part of the periphery of smaller diameter, whilst the out-going portion is being paid off the lower part. Arrangements of driving apparatus which obtain their adhesion by putting opposite turns in the ropes, must prove more or less injurious to the latter. This fact appears well demonstrated by the difference of wear between top and bottom winding ropes at collieries, although the conditions are comparatively favourable, as the drums may be large.

The Tredegar Iron Company's exhibit represented a siding, with one central passing place and an inbye landing, between which there was a curve subtending an angle of 94 deg., or having a radius of 66 ft., previously mentioned as being common to most of the systems that were shown. The way was composed of fished steel rails of 24 lb. per yard laid to a gauge of 2 ft. 4 in., and secured upon the Tredegar Company's patent steel sleepers, weighing 16 lb. each, including fastenings. The endless rope was driven by a tapering pulley as already explained, operated by an electric motor, and was taken through the main road, sidings, and landings, and controlled at the curved points and switches by means of "bonnet" pulleys. The

www.libtool.com.cn on the straight portion of the line were fixed about 20 yards apart.

In order to allow the tubs or wagons to cross the haulage rope (which is carried only a few inches above the ground) and the switches, two shifting rails or movable pieces were provided at each junction, so curved as to permit the rope to travel freely beneath it when in position. These switches were raised by attendants travelling with the tubs, who ran on ahead so as to prepare the road for the arriving sets; this appears a weak point in the system, for surely some arrangement might be devised to dispense with the movable rails, or else render them automatic in action. The rope was carried by horizontal or inclined pulleys at the curves.

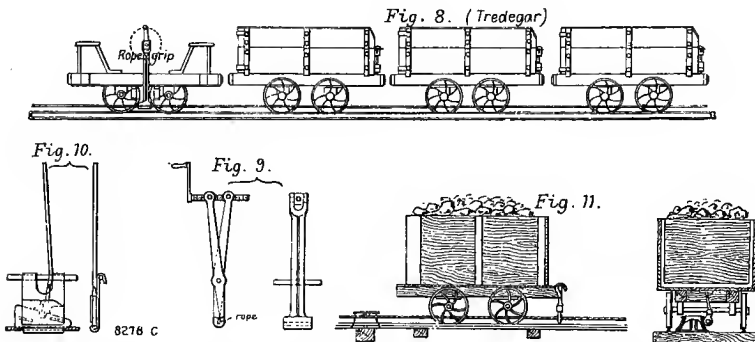

In practice, at Tredegar, the sets or groups comprising from fifteen to thirty-five tubs, had a gross weight of from 27 cwt. to 30 cwt. each, with a tare of about 7 cwt. Connection with the haulage rope was effected by means of screw clips carried by an independent leading bogie car, which heads the train. A portion of a train of sets led by such a car is shown in Fig. 8. Figs. 9 and 10 are detached views of the gripping appliances carried by and operated from the leading vehicle. The rope clip shown in the first figure consists of a screw tong device, wherein the haulage

rope was grasped at the lower end by screwing the upper extremities together. Fig. 10 is a modified arrangement of rope-gripping apparatus, which consists of a horizontal wedge block, operated by a lever so as to force a top piece down upon the rope against a fixed lower jaw. The leading cars are so constructed that the rope-gripping appliances may be moved to either side so as to suit the position of the rope.

This system of haulage was adopted in order to obtain a continuous and slow-speed service, without the necessity of a double way throughout, which the nature of the gallery roofs rendered impossible. In practice, one leading or bogie car can draw from 400 cwt. to 500 cwt. a distance of about 800 yards. The working of this system is seen to advantage on level roads or easy gradients. The Tredegar Company have other systems of rope haulage at work in their collieries, *e.g.*, the main and tail-rope system in the Whitworth drift, and the endless rope system over the tubs as well as under the tubs on the Clifton Colliery system. The arrangement just described has been found to work well, and meet certain conditions and requirements encountered in Welsh collieries; at the Bedwellty pits the total working cost is given at 1.8d. per ton per mile.

Passing on to the Hodbarrow Mining Company we find another arrangement of the endless rope working under the tubs. This system consists practically of a double way throughout (except at the landings), and is arranged to haul only single tubs of coal or minerals; the wagons with their hook and grip attachments are represented in side and end view at Fig. 11. Fig. 12 is a front elevation of the rope-clipping apparatus used by the Hodbarrow Company, and in which the body of the clip-shank terminates at the top with a hook for attaching to the tubs, and at its lower extremity with a recessed portion G for receiving the rope; H is a sliding collar with a piece which fits into an aperture

h, so as to grasp the haulage rope; *I* is a stud or stop to control the collar-piece. This method appears to work very well, but the tractive adhesion attained by such a clip as that last described does not seem so efficient as in a similar contrivance used by the Castle Eden Company, as shown at Fig. 14.

The Hetton Coal Company showed the main and tail-rope in operation, and, after what has already been stated about the system, little remains to be added. This system

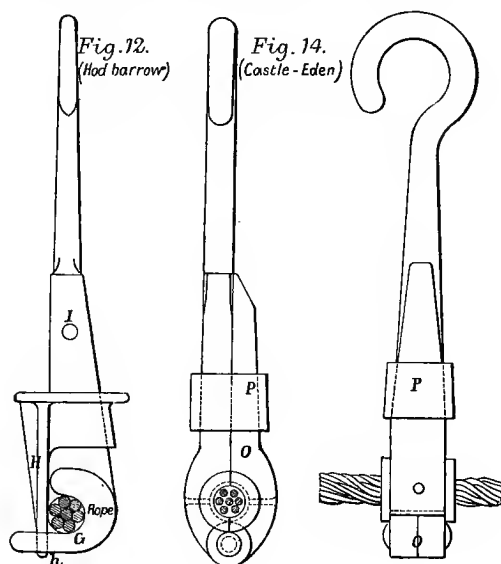

of working is over thirty years old, but it is still a valuable one in cases where it is required to periodically convey considerable quantities of mineral from a station in the workings to the pit shaft. For example, at the Hilda Colliery, near Newcastle, one of the longest underground sets in the country may be seen daily hauled a distance of about two miles from the workings to the shaft by means of the main and tail-rope system, there being about 100 tubs to the set, equal to about 80 tons when loaded,

the speed of haulage being about ten to twelve miles per hour.

The endless rope system, applied under the tubs, driven at a moderate speed over a double way throughout, appears undoubtedly an excellent method of working underground haulage, and preferable to the intermittent and high-speed deliveries of tubs over single lines by the main and tail system, which spasmodically strains the engines, machinery, and ropes.

However, on the other hand, it must not be lost sight of that certain conditions of working, peculiar to different districts and mines, dictate different methods of transporting the mineral produce. Where double lines can be consistently laid down, and an uninterrupted supply of coal to the shafts can be maintained from one or several workings along the route, the endless rope system is highly advantageous and economical.

The Whitburn Coal Company exhibited an endless rope system similar to that of the Hodbarrow Company, the only point of interest being the rope clip. This apparatus is shown in side elevation and transverse section in Fig. 13, and consists of a pair of metal cheeks $J J^1$, terminating with a clipping device, and mounted free to move laterally about the pin or fulcrum K . A wedge piece L , formed at one end of the operating lever, has studs M on the sides thereof, which fit into the recess N , when the lever is forced down so as to release the rope. When the lever is raised the projections M are pulled out of the recesses, thereby forcing the upper parts of the cheeks $J J^1$ apart and closing the lower portions of the same so as to grasp the rope. These clips are attached to the tubs by means of the links T .

The Harton Coal Company's method of working the endless rope system as applied beneath sets of tubs, arranged to travel on a special form of way, is shown on the plan.

According to this arrangement three rails and one or more sidings are provided for the passage of the full and empty tubs. The endless hauling rope is arranged to travel on either side of the central rail, and is diverted through the sidings as indicated by the dotted lines in the illustration. No points or switches are required to control the passage of the tubs, which are attached in sets to the hauling rope by means of any convenient grips.

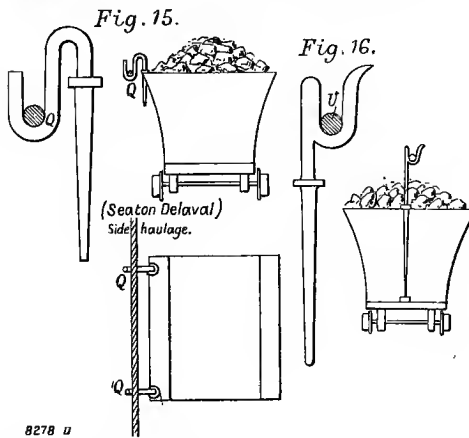
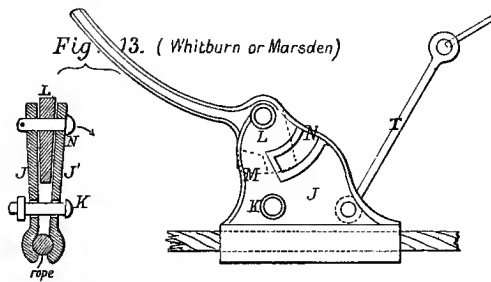

The Castle Eden and Eldon Companies' examples of the application of endless ropes under the tubs in "singles and sets" were, with the exception of small details, very similar to the systems already described, a common difference being in the width of the ways and in the gripping appliances used. The rope clip employed by the Castle Eden Company

is shown in front and side elevation at Fig. 14; it consists of a similar arrangement to that used by the Hodbarrow Company, that is to say, a hook clip formed with a hinged piece O, which is caused to grasp the rope by means of the movable collar P.

The application of the endless rope to the side of the tubs was next shown by the Seaton Delaval Coal Company, and the arrangement by which the rope was carried will be understood on reference to Fig. 15. The supporting and clipping hooks Q are composed of simple rod forgings placed in sockets on the sides of the wagons arranged for their reception. It is considered by some that this method of haulage is easier on the ropes and engines than where the ropes are used under the tubs. However, it is somewhat difficult to see the advantage of dispensing with ground pulleys and substituting vehicles (about every 20 yards apart) to carry the rope, so long as the system is in operation and independent of whether an uninterrupted transportation or service of minerals can be maintained. Further, hauling from the one side of tubs must, to some degree, increase the tractive resistance and depreciation of the system.

In April, 1882, Mr. Hyslop communicated to the Mining Institute of Scotland some valuable information respecting the result of his research on rope haulage, and upon the ratio in which tractive resistance is increased by hauling tubs from one side instead of the centre. Mr. Hyslop found that side attachments tend to twist or cant the wagons, and thus cause the wheel flanges to press against the rails proportionately to the gauge and inversely to the length of the wheel bases. The lateral friction thus set up is of a rubbing and not rolling nature, and therefore in the case of heavy loads the increased resistance and wear and tear of the way and rolling stock must prove considerable. From the position of the rope, on the side haulage system, it is

www.libtool.com.cn
 evident that it travels outside the rails, and must therefore be supported and guided round curves by means of raised horizontal pulleys. It is, obviously, more difficult to deal with curved portions of line in cases where the hauling rope is carried at the side or top of the tubs than when it is taken beneath the same.

The Bedlington Coal Company showed at Newcastle the endless rope system as applied to the top of the tubs. This system appears to retain some of the weaknesses apparently adherent to the side-rope system, *e.g.*, tubs constantly running to carry the rope and cumbersome gear at curves to control the same. Fig. 16 shows a detached view of the rope clip and support, which is centrally mounted upon the wagons or tubs so as to carry the rope U, about 4 ft. from the ground. At curved portions of the line, expensive and cumbersome pulleys, A, about 4 ft. in diameter, had to be set up as shown in the detail view, Fig. 17, other-

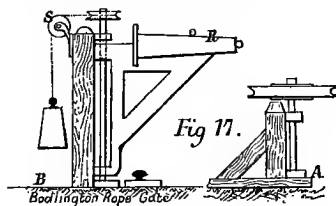

wise the tubs would have been pulled over by the lateral force of the rope, and in order that the latter might be maintained in a proper position, swinging supporting gates, B, were provided along the line, as shown in the same figure. These hinged gates were fitted with rope-supporting rollers R, and counterweighted controlling mechanism S, so that after the approaching tubs pushed the gates aside, in order to pass clear of the same, they were subsequently returned to their normal positions, so as to hold up the rope at the rear of the tubs to the plane of the curve pulleys A.

Another arrangement of endless rope haulage applied to

the working of single lines with passing places, was exhibited by the Moresby Coal Company, the hauling engine being supplied by the Lowca Engineering Company, Limited, of Whitehaven. The permanent way of this exhibit was composed of steel rails and sleepers furnished by the Moss Bay Hematite Iron & Steel Company, and it was equipped with cast-steel sheaves or pulleys by Messrs. C. Cammell & Co. About midway on the engine plane a siding was arranged to allow the full and empty sets to pass, but this exact position is not necessary in practice. The endless rope was carried over a series of pulleys along the full road, and arranged to pass under the rails at the "in-bye" end of the siding, where it practically served as a tail-rope. There is usually a curve of 20 ft. radius between the siding and the in-bye end of the plane, where the rope is maintained in its proper working position by several steel sheaves of 9 in. diameter. According to this system the working direction of the endless rope is alternately reversed, so as to haul the full tubs to the shaft and the empty tubs to the working stations.

The principal feature of this arrangement was Mr. Ramsey's clutch bogie for gripping and releasing the haulage rope, and which is represented in longitudinal section by Fig. 18, in transverse section by Fig. 19, and plan in Fig. 20, whilst Figs. 21, 22, and 23 are detached detail views. This improved method of attaching the tubs or vehicles to the hauling rope consists in a novel arrangement of grip carried by a specially constructed bogie or leading car to which the vehicles are connected. The bottom jaw A of the clip is arranged to work about a fulcrum a , so as either to form a base against which to grasp the rope or to fall out of gear so as to allow the rope to drop clear of the apparatus. The jaw A is raised and maintained in position by moving the lever or trigger D over the opposite end C of the lower jaw-piece. The top jaw of the clip B is attached to a screw

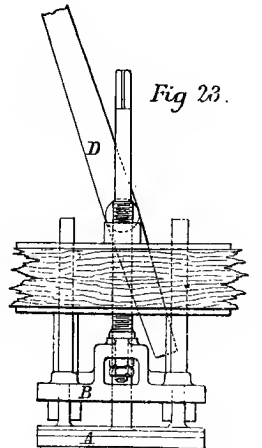
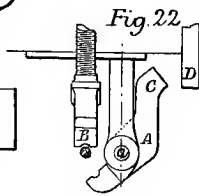
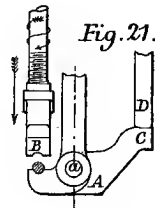
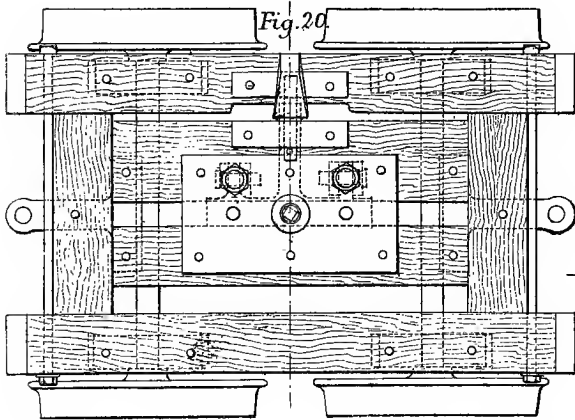
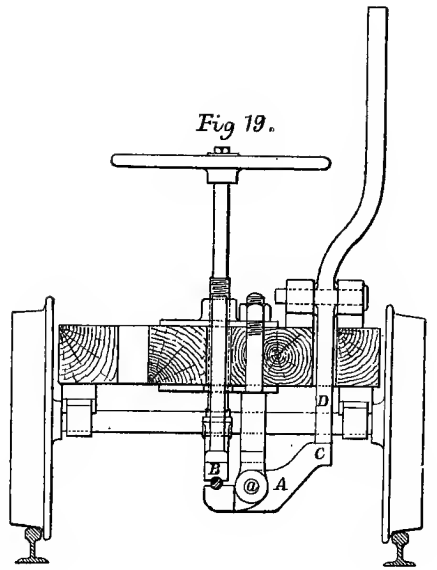
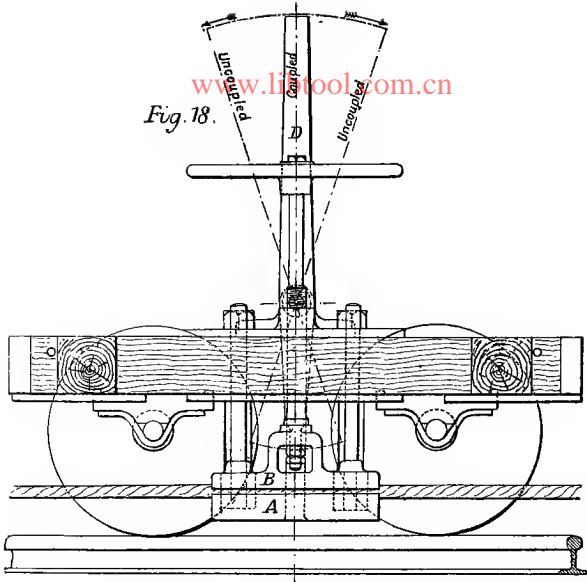

8278 G

RAMSEY'S CLUTCH-CAR.

www.libtool.com.cn

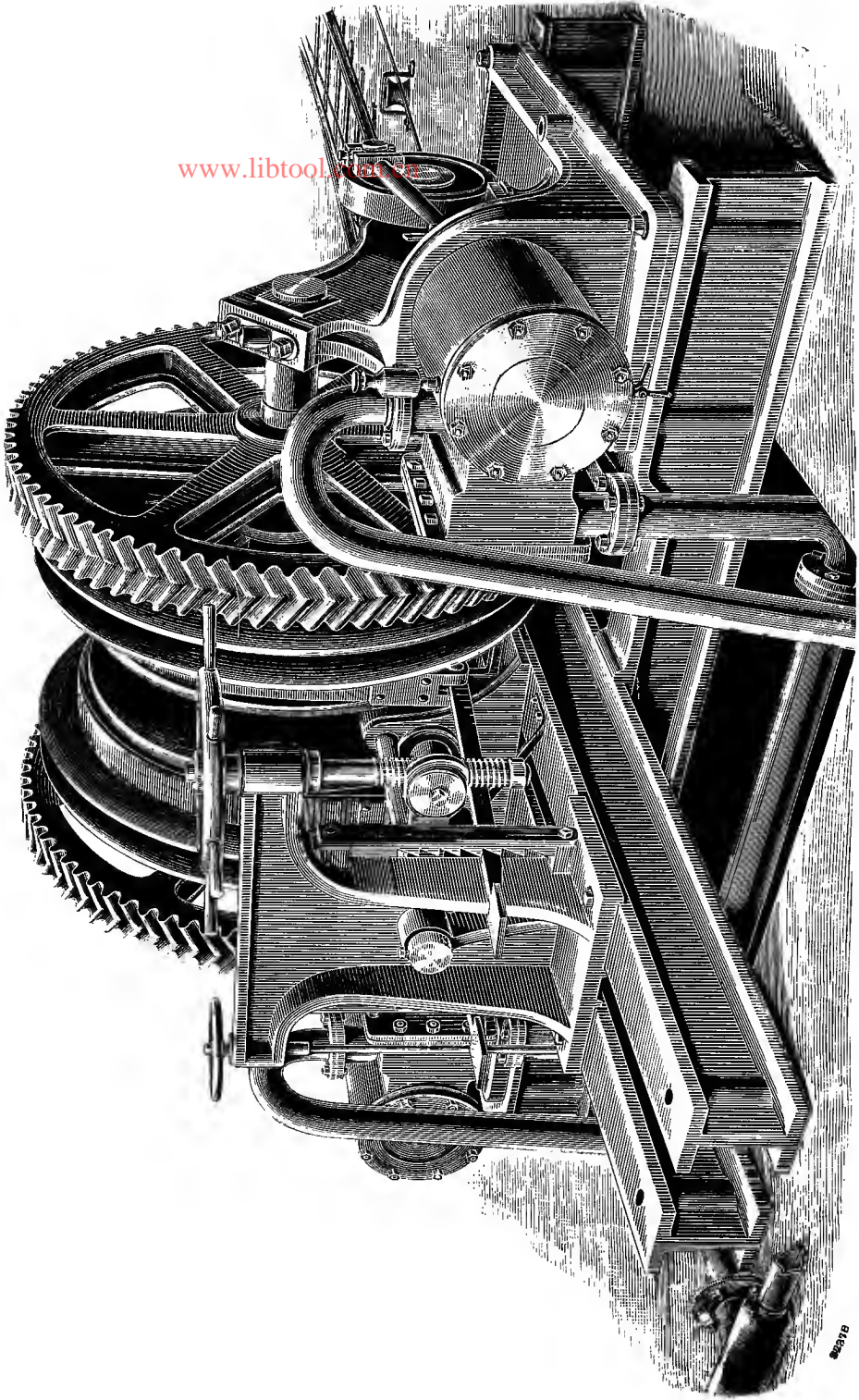

FIG. 24. MINING ROPE-HAULING ENGINE.

spindle capable of being screwed down towards A, so as to grasp the rope between it and the lower jaw.

In Figs. 18 and 19 the haulage rope is shown tightly embraced between the jaws of the gripping apparatus, and the motion of the rope is thus imparted to the bogie and wagons attached. Fig. 21 shows the bottom jaw held up in position by the lever D ready for clipping the rope by the descending top jaw, whilst Fig. 22 represents the lower jaw released from the lever D and out of gear, so as to permit the haulage rope to fall clear of the apparatus. The release of the rope may be governed by an attendant upon the bogie, or the action may be rendered automatic by providing tappets on the line which will engage with the lever D, where it is necessary to release the rope. In this manner it will be understood that the grip grasps or releases the haulage rope underneath the bogie, which can be detached at any point on the road. In practice such an equipped bogie car is provided at the front and rear of each train of tubs, and these can be so arranged as to keep the couplings quite tight. It will be further seen that the appliances allow the rope to be returned to the pulleys in its proper position.

Fig. 24 represents the back elevation of a hauling engine made by the Lowca Engineering Company. The cylinders are 10 in. in diameter, with a 12-in. stroke. The engine is compact, self-contained, and requires no foundation. The duplicate helical gearing is in the ratio of 5 to 1. There are two driving drums 4 ft. in diameter, with a friction clutch between them, which can be thrown in and out of gear when the engines are running at full speed. Each drum is provided with a strap brake, which throws itself out of gear on releasing the brake lever. The drums are designed for endless rope haulage, and around these the rope is wound two or three times to obtain the requisite driving adhesion. The rope is kept taut by passing round a terminal tension pulley as before described.

The last haulage system was that operated with an endless chain, and after what has been already stated little remains to be added. Fig. 26 shows an end view of a tub arranged to receive the links of a haulage chain at V; this was exhibited by the Hebburn Coal Company. It is evident that the method of attachment is very simple, as the vertical links of the chain fit into the recesses V

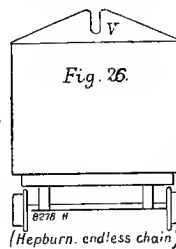

provided on the tubs, whilst the horizontal links act as stops against which to haul; in other respects the system is practically identical to the endless rope system over the tubs.

Figs. 27 to 34 illustrate Messrs. Rutherford & Thompson's patent haulage clip. This ingenious appliance is shown attached to a tub or wagon in side and end elevation at Figs. 27 and 28 respectively, whilst detail views of the rope-gripping apparatus are represented in Figs. 29 to 34 inclusive. Figs. 29, 30, and 31 show an end, side view, and plan respectively, of one arrangement of Messrs. Rutherford & Thompson's automatic fork rope clip, whilst Figs. 32 to 34 represent similar views of a modified construction of the apparatus. According to the first arrangement, the clip is composed of two oscillating jaws Y Y¹, which are mounted on pins and geared together as shown in the plan Fig 31. The action of this apparatus is automatic, for when a wagon carrying the clip is conducted into the plane of the haulage rope, the motion of the latter through the jaws of the clip causes them to close upon the rope by frictional

contact and grip firmly. According to the modification shown in Figs. 32 to 34, the jaws are capable of being opened and closed transversely about the pin joints $y y^1$, in addition to being free to receive angular motion about the

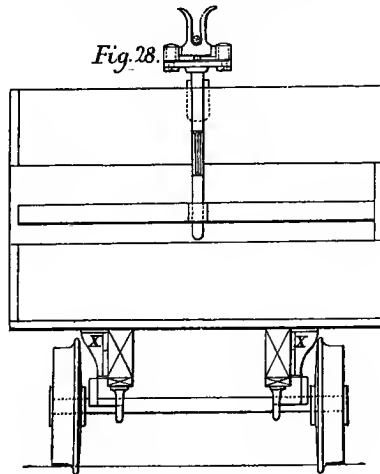
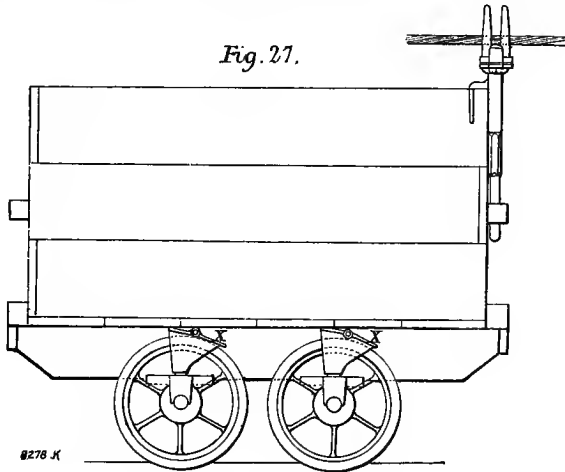

fulcra $Y Y^1$; this is arranged to give greater facilities for removing the rope. These appliances allow the tubs to be hauled centrally, and thus reduce friction, and liability to leave the rails. This system of attaching the tubs has been

used by the South Derwent Colliery Company for some time past, and at present over eight miles of the system are in operation.

The wagons represented in Figs. 27 and 28, are also fitted with Messrs. Rutherford & Thompson's lubricators and pedestals, marked X, by the use of which a saving of 50 per cent. of grease is claimed over the ordinary methods

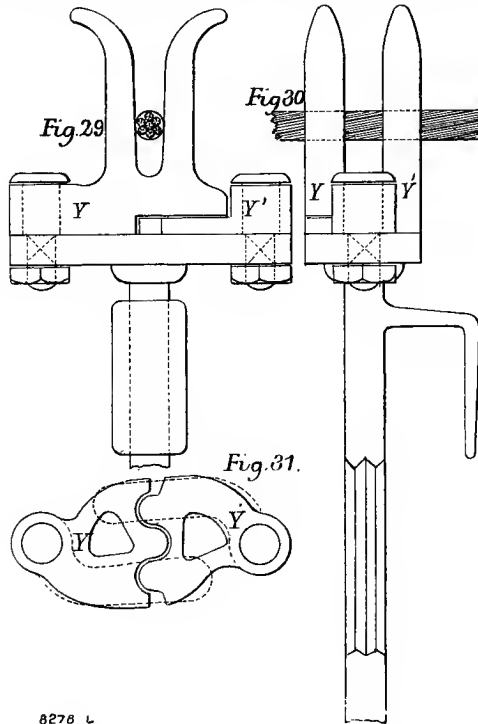

8276 L

of oiling, based mainly upon results achieved at the West Shields Row Colliery, Durham, where they have been in constant use for some years. In this case, the tubs greased by hand consumed 4.084 lb. per tub per eleven working days, whereas those fitted with the patent lubricators only consume 1.875 lb. under similar conditions, thereby showing a saving of 54 per cent.

In connection with the important question of lubrication, Figs. 35 and 36 show in a longitudinal section and

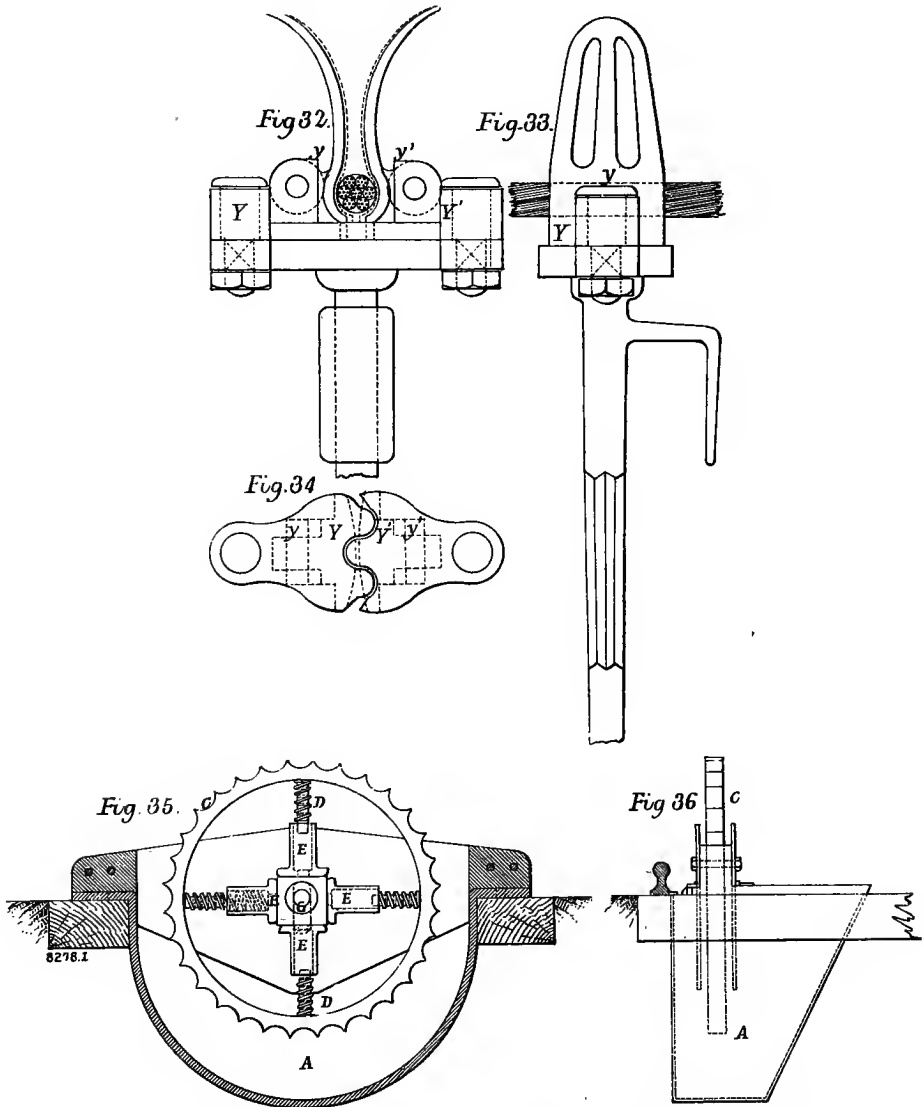

end view Messrs. Dunford Brothers' automatic greasing apparatus. To effectually grease colliery tub axes has

been a matter that has engrossed considerable attention. The apparatus in question consists of a cast-iron semi-circular trough A, fixed between the rails, for containing the grease or lubricant, and within which a steel serrated wheel C is mounted, the peripheral corrugations on which serve to raise sufficient grease to lubricate the passing axles. This wheel has four arms D working into corresponding radial sockets E against spiral springs, and arranged about the spindle G, so that when struck by a passing axle the wheel may assume an eccentric position. These automatic greasers may be placed in any convenient parts of a pit, so as to lubricate the axles of the passing wagons at whatever rate they may be travelling, the axles only removing a sufficient quantity of grease necessary for the purpose, and, therefore, very economical results are claimed.

Fig. 37 represents a section of Blackett's wire-rope socket.

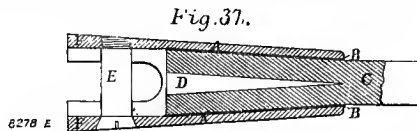

The cap or socket A, made of iron or steel, and fitted with a lining B of some soft metal, is placed round the rope end C, which is brought into proper position, and then forcibly driven outwards against the lining B within the socket, the wire ends being held asunder by a tapered plug D, made of soft metal similar to the lining B. A bolt E, which serves to carry the load, or another socket, passes through a double eye. This arrangement forms a strong and compact job, and the process of socketting can be easily and rapidly performed.

Attaching ropes to joints or sockets by means of pins or rivets driven through the former are detrimental if not dangerous measures.

The speeds at which underground endless haulage

www.libtool.com.cn

Fig. 38 represents the common conditions under which vertical winding ropes are called upon to operate. A is the hoisting drum, upon which the ropes a a' work to and from the shaft over the head pulleys B, mounted free upon a transverse fixed spindle. C is one of the cages working within the controlling guides D. The top rope a passes directly over the head wheel to the cage, whilst a' has a reverse

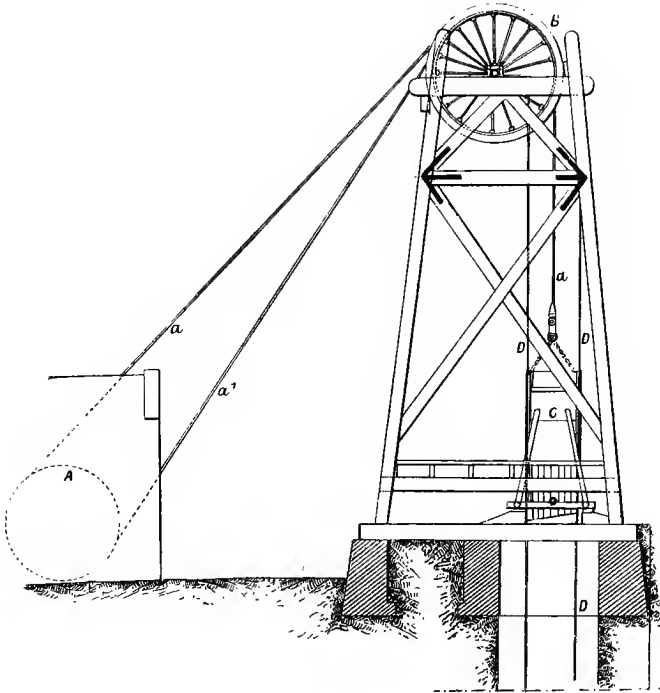

FIG. 38.

bend put in it as it passes from the underside of the driving drum to another cage. This arrangement permits of one cage being raised whilst the other is simultaneously lowered. The strains of contraflexure exerted upon the bottom ropes, however, usually shorten their lives from 15 to 20 per cent. as compared with the services of the top ropes. Further,

the angles at which ropes are worked in relation to their winding drums also influence their durability.

We will now turn our attention to the examination of a few descriptions of typical aerial ropeways for transporting minerals or similar produce. With such object some illustrations of Carrington's and Otto's methods of overhead transportation are now appended, and which will suffice to convey the applicability and capabilities of such contrivances.

Mr. Carrington has successfully applied the following four systems of aerial ropeways: Single running ropes; double fixed ropes and gravitation working; single fixed ropes and double fixed ropes with power applied to operate the "carriers."

According to the first system, lines have been constructed capable of carrying 20 tons per hour over a distance of 500 yards, at a working speed of about $3\frac{1}{2}$ miles per hour. The cost of maintenance may be about 1d. per ton transported.

The aerial way erected at the mines of the Sentein Mining Company, in the Pyrenees, affords an example of the second method of conveyance. The length of this line is 2844 yards, whilst the mines are situated 7000 ft. above the level of the sea, the distance to the dressing floors being 2 miles. The question of economical means of transportation was obviously very important, in order to be able to work such mines profitably. Five gravitation ropeways were consequently erected, the lower terminals of each being connected with the next of the series; the longest way is 978 yards, and has a fall of 430 yards. The fixed ropes are composed of crucible steel wires of 75 tons breaking strain. The "carriers" have a capacity of 15 cwt. each, and about 80 tons of minerals are brought down this line daily, the total cost of conveyance being estimated at 3.2d. per ton. The cost of the works was about £5000.

A short line erected at the Nine Elms Gasworks may be

cited as an example of the use of a single fixed rope of 40 tons breaking strain for carrying coal across a dock to one of the retort houses—a distance of 450 ft., with an incline against the load of 1 in 19. Here the inclusive cost is given as 1.28d. per ton, and rate of transport about 30 tons per hour.

Such a class of ropeway is particularly suitable for conveying produce or goods, &c., across a space where intermediate supports cannot be employed.

The last, or double fixed rope system, with power applied thereto, is exemplified in the line owned by the Monte Penna Forest Company, whose lands are situated at the summit of the Apennines. The standing ropes have breaking strains varying from 25 to 40 tons, according to their position, whilst the hauling rope is composed of plough steel $1\frac{1}{2}$ in. in circumference, with a breaking strain of $8\frac{1}{2}$ tons. The length of this line is 2610 metres, the longest clear span being 680 metres. The loads of timber carried vary from 5 cwt. to 15 cwt. The cost of construction and equipment was about £4000, and the capacity of the line is some 200 logs and 25 tons of charcoal per day of ten hours, costing £4 per diem.

The foregoing brief particulars will suffice to prefatorily explain the economical advantages of ropeways for transporting materials and goods in situations where roads and railways are impracticable or too costly to construct. Some 500 miles of aerial tramways, constructed according to the running rope system, have been erected in various parts of the world by Messrs. Bullivant & Co., from the designs of Mr. Carrington, amongst which may be cited those in Mauritius for carrying sugar cane, and others in the South of India, &c. Another special arrangement of ropeway, designed and erected by the previously named gentlemen, is that somewhat recently constructed at a large sugar refinery in Hong-Kong, and as represented in elevation and plan at Fig. 39 of the illustrations.

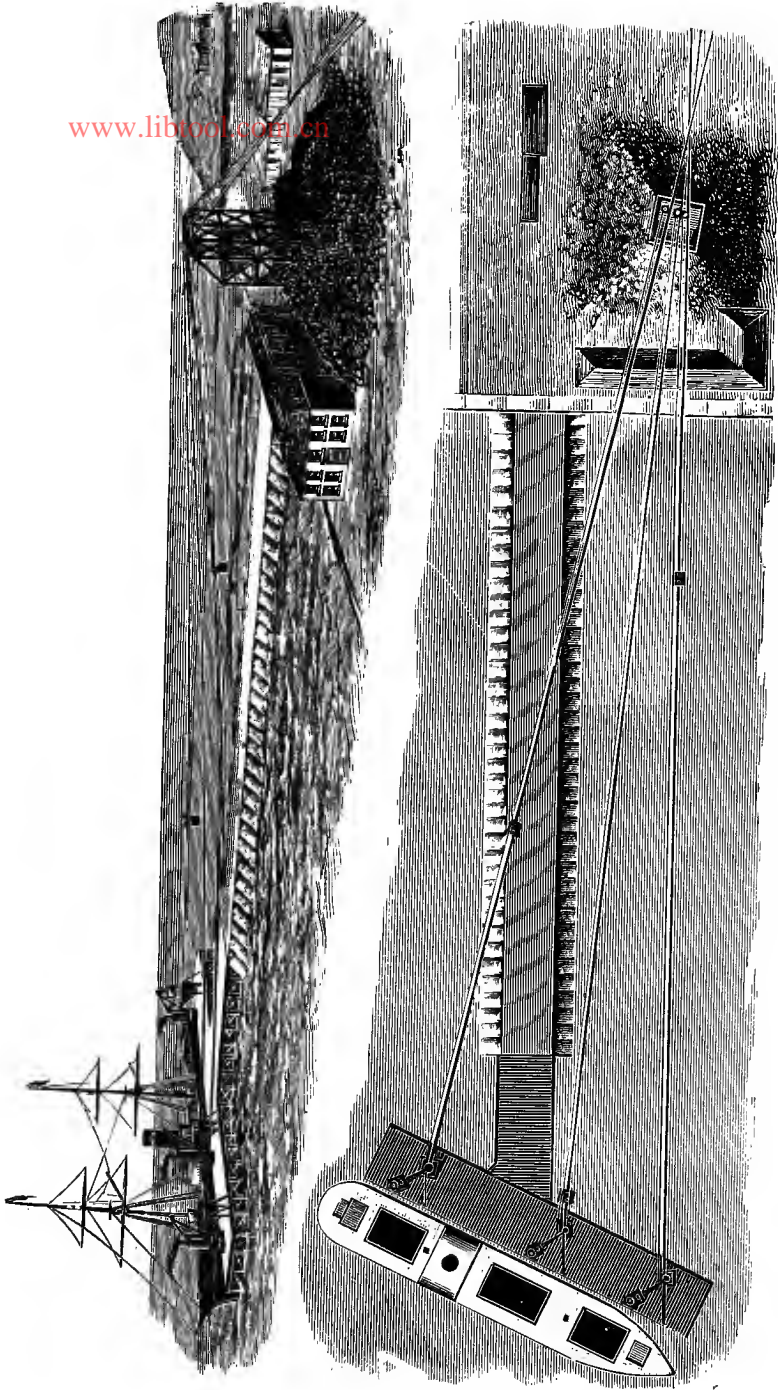

FIG. 39. AERIAL ROPEWAY AT HONG-KONG.

www.libtool.com.cn

The system has to carry 1000 tons of coal per day from steamers moored to the pier head to a central coal depôt, about 2000 ft. distant—a stipulation having been made that the pier and its approaches (fully occupied with other work) were not to be encroached upon. The arrangement shown was therefore adopted, and in which a tower, about 70 ft. in height, was erected on the site of the coal store; from this three lines of single fixed rope tramways are carried to points on the pier head convenient for filling the buckets

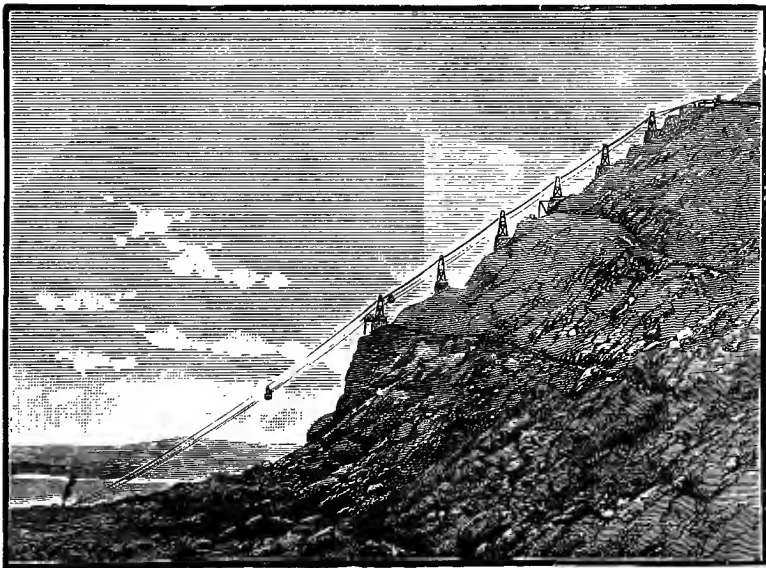

FIG. 40.

from vessels alongside. Only one bucket, holding 16 cwt., is run to and fro at a time on each line. The ways are actuated by a small engine situated on the top of the tower.

The coal on its arrival is delivered into a hopper in connection with a weighing machine, which, by the movement of a lever, is discharged from the same into the coal store.

Another aerial ropeway of rather a special character has

also been somewhat recently designed and constructed by Messrs. Carrington & Bullivant, for conveying men and

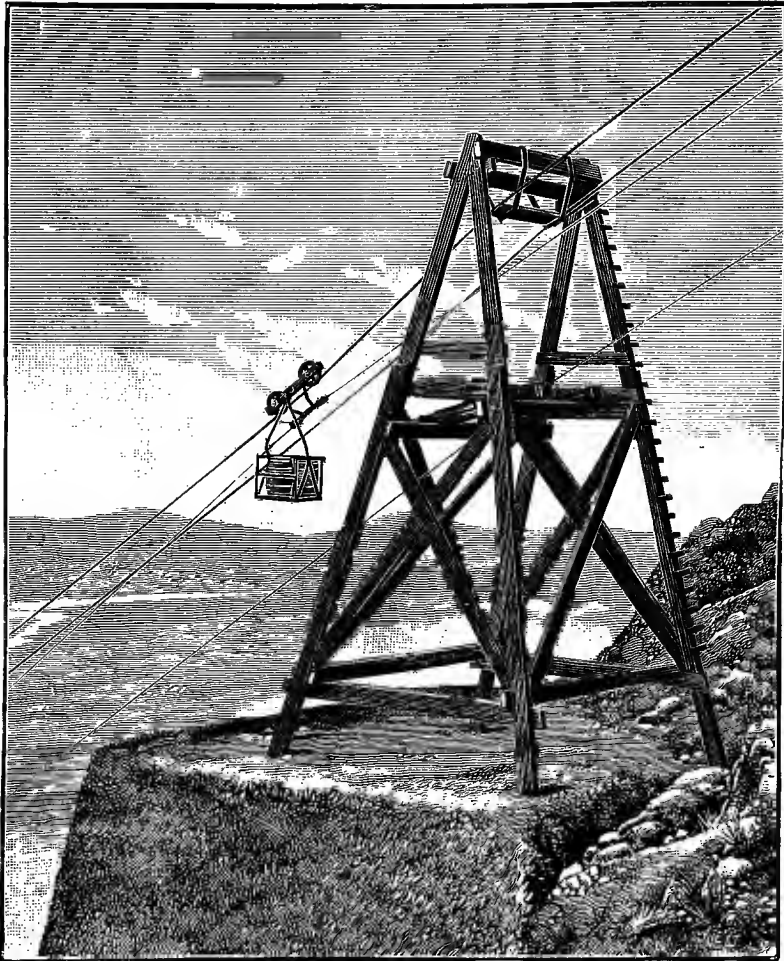

FIG. 41.

stores from the town of Gibraltar to the fortifications at the summit of the rock, views of which are given at Figs. 40 and 41 of the accompanying illustrations.

In this case the incline is about 1 in $1\frac{1}{2}$, the length being about 2200 ft., and the vertical height some 1200 ft.

The maximum weight specified to be carried was 10 cwt., exclusive of the carrier.

It was further necessary to provide certain delivering and loading stations at various points along the line, and also to arrange that the control of the whole system should be had from the bottom or town end.

The line is constructed on the double rope system, and is provided with six supports in its length, the longest span being 1150 ft. The motive power is supplied by a steam engine situated at the lower end of the ropeway, whilst a suitable brake device is provided for controlling the operation of the line. This ropeway is operated at a speed of five miles per hour.

Reference being had to the accompanying illustrations will convey a faithful idea of the character of the ground passed over and surmounted by this aerial line.

The work was executed for the British War Office authorities. A somewhat similar contrivance was erected some twenty years ago at Purfleet, on the Thames, for transporting barrels of gunpowder.

The special feature of Otto's system of aerial transportation is that a *fixed* rope is employed for carrying the load whilst the buckets are hauled along it by an independent light and flexible rope. By this means the class of carrying ropes can be varied to suit the spans and loads encountered, and, further, be composed of wires of large section (see page 185), to insure a longer life. Where only a single rope is used for carrying and hauling purposes it is considered impossible to combine these features essential to the successful working of some ropeways. Otto's system of transportation has advanced much of late years, 450 of these ropeways being now at work in various parts of the world.

Fig. 42

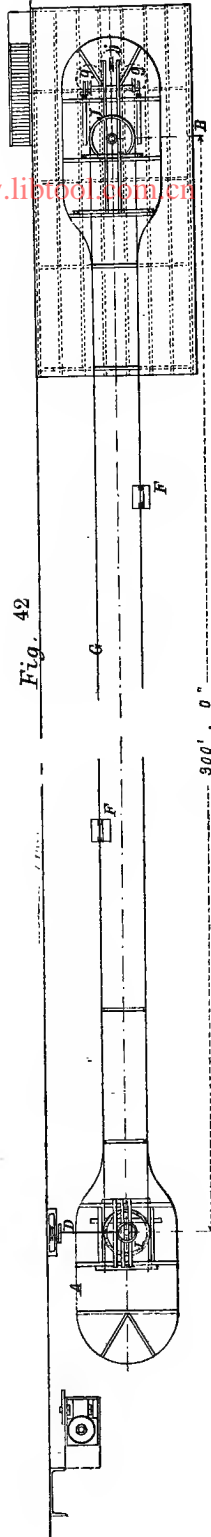
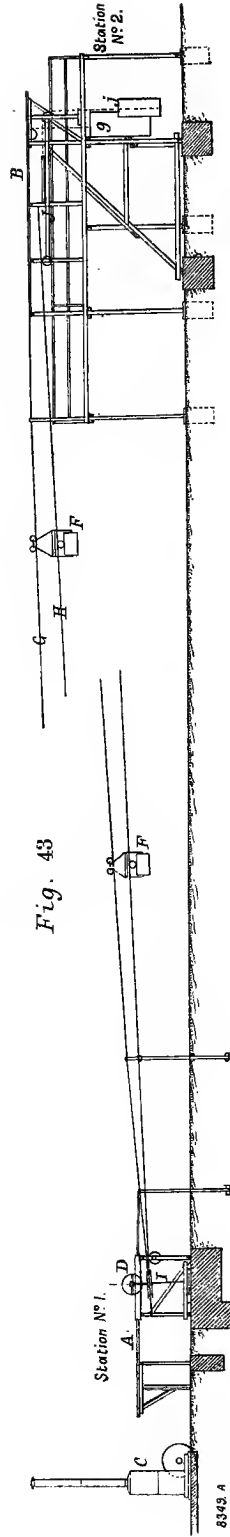

Fig. 43



THE OTTO SYSTEM OF AERIAL ROPE HAULAGE.

Without such or similar means of communication many mines must have remained unworked owing to the impossibility of transporting the ore at anything like a remunerative rate, an example of which may be cited in the case of the Garrucha line, particulars of which will be given later on.

The success achieved by lines constructed according to this system is stated to be largely due to the care taken in designing the various details, the general arrangement of which and method of working are explained by the accompanying illustrations. Figs. 42 and 43 represent an elevation and plan of a short exhibitional line driven by an engine C, and gearing D.

The fixed carrying rope G on the loaded side, held taut by weights *g*, in this case is $3\frac{3}{4}$ in. in circumference, and that on the empty side $2\frac{7}{8}$ in. in circumference. The hauling rope H passes round the terminal pulley I and tension pulley J, held back by weights *j*.

One type of iron standard used for the ropeway is shown in Figs. 44 and 45, and in these views the buckets F, runners K, grips L, and pulleys M for the hauling rope, are indicated. From the illustration of the runner or truck, given in Figs. 46 and 47, it will be seen that it consists of a cross-piece composed of two steel plates NN' and three distance-pieces, two of which form spindles O of the wheels O', which are hollowed out for the reception of grease or other lubricants.

The advantage of this form of construction is that the grooved wheels cannot get twisted, the spindles being supported at both ends, and not at one end only, as is the case with many forms of runners. A great saving in the wear and tear of the spindles and wheel bosses is thus effected.

Figs. 48 and 49 represent the form of friction grip employed with the buckets; it consists of two discs P P', which may be screwed up to tighten on the hauling rope

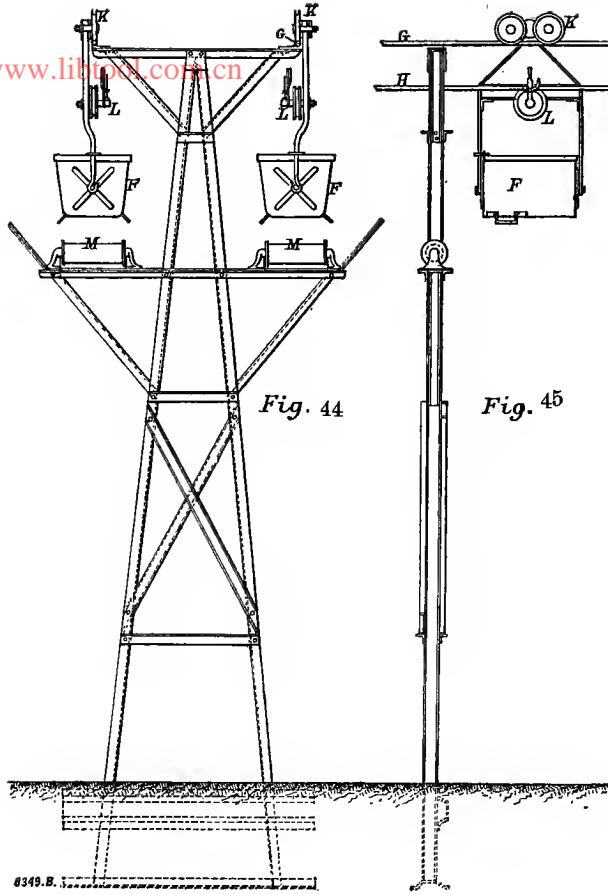

Fig. 44

Fig. 45

8349.B.

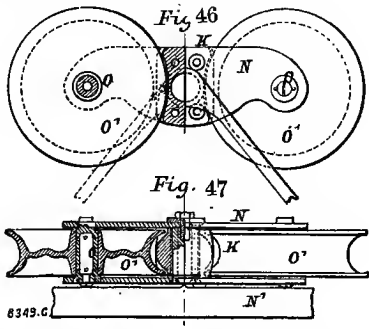

Fig. 46

Fig. 47

8349.C.

STANDARDS, RUNNERS, AND GRIPS, &C., USED ON ROPEWAYS.

by the lever *Q* with catch-rod mechanism or releasing gear *q*. As the buckets approach the stations, the levers come in contact with fixed plates which release the grip of the discs on the hauling rope, so that the buckets can be run round by the attendant on the fixed rails of the siding, who, after filling or unloading the same once more throws the grips into action by hand, and the buckets are again carried by the rope in the opposite direction.

The disc grip subjects the hauling rope to the least wear,

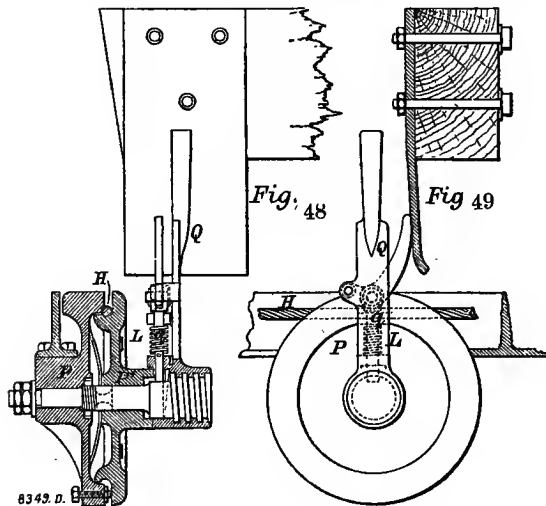

and readily admits of an extension in the carrying capacity of a line by simply adding more carriers at required intervals. Where the gradients however, exceed 1 in 6 a friction grip with corrugated jaws is sometimes used, but with gradients over 1 in 3 the pawl or knot-grip, shown in Figs. 50 and 51, is employed.

This consists of two symmetrically-placed pawls *A*, free to move in a vertical plane, and slip down on either side of the knot *F* or stop on the rope, the movement of the same being controlled by suitable studs. The hauling rope

is supported on a roller *D* below the pawl-gear, which is thrown automatically out of gear by the pins *B* upon coming in contact with sloping guide rails at the stations, and which thereupon lift up the same so as to release the

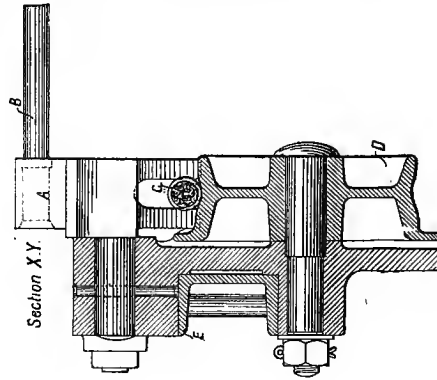

FIG. 51.

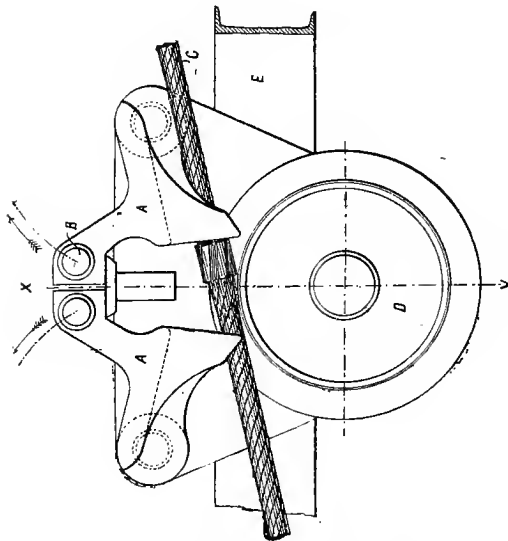

FIG. 50.

hauling rope, thereby leaving the bucket free to be switched on to the siding. To reattach the buckets a workman moves the carrier by hand along the shunt-rail of the

station on to the carrying rope, on approaching which the pawl-pins come in contact with the guide-rail, thereby raising the pawls so as to allow the hauling rope to rest on the roller immediately below them. As soon as the carrier rests on the stationary rope the pins B are released from the rail, and the pawls A fall down into position over the running rope. When a knot approaches, it lifts the first pawl it comes in contact with, which then falls back into its original position, but the second offering a fixed resistance, the bucket is automatically taken in tow. To avoid the knot striking the coupling violently when thrown into

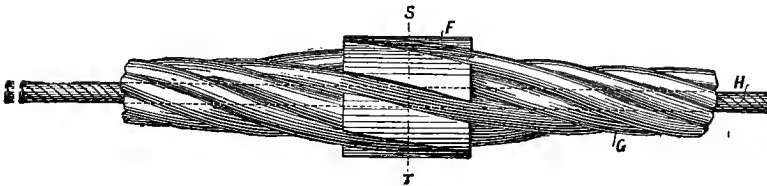

FIG. 52.

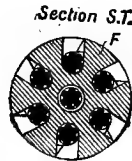

FIG. 53.

gear, a signal is given to the shunter (by ringing a bell), indicating that a knot is approaching, whereupon he pushes off the carrier at about the same velocity as the travelling rope.

The design of the knot is almost as important as that of the grip itself, the latest and most improved form of which is shown in Figs. 52 and 53. The following advantages are claimed for the device:

1. The knots can be quickly attached to the hauling rope and removed therefrom when worn out without cutting the same.

2. It is not necessary to employ Babbitt metal for fixing the knots, and which earlier practice was found to very much impair the strength of the rope.

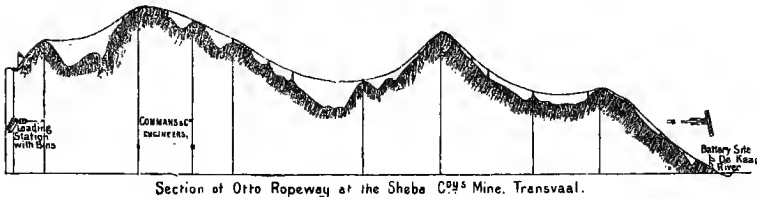

FIG. 54.

3. The hauling rope does not lose its flexibility at the points of attachment.

4. Any breakage of the wires is at once visible and easily repaired.

The accompanying section, given at Fig. 54, represents the ropeway erected in the Transvaal for the Sheba Gold Mining Company, and indicates the steep gradients and rough country traversed by the line.

As examples of what has been done with this system of aerial haulage the following particulars may be of interest :

The Garrucha Line has a—

- Length of $9\frac{3}{4}$ miles, and a
- Capacity of 500 tons per day of 10 hours.
- Maximum Incline : 1 in 3.
- Greatest Span : 918 ft.

The Sheba Line has a—

- Length of $2\frac{3}{4}$ miles, and a
- Capacity of 150 tons per day of 10 hours.
- Maximum Incline : 1 in 1.6.
- Greatest Span : 1480 ft.

The Edwin Bray Ropeway has a—

- Length of $3\frac{3}{4}$ miles, and a
- Capacity of 150 tons per day of 10 hours.
- Maximum Incline : 1 in 1.8.
- Greatest Span : 1600 ft.

In the diamond mines of South Africa wire ropes were until recently commonly worked under very severe conditions. In the first place, some of the plant was and even is still of primitive construction, whilst others are rudely erected. Here the gross weight of the loaded buckets worked over aerial lines ranged from an average of about two tons and upwards, and the speed of winding about 1000 ft. per minute. Sixteen cubic feet of diamondiferous soil were originally considered a load, but later the average charge for aerial gears attained 32 cubic feet, whilst some aerial tailing tubs attained a capacity exceeding 50 ft. Skips holding 96 cubic feet are employed in some of the shaft workings. The standing ropes over which the tubs were worked from the open mines to the surface were fixed at an average inclination of about 45 deg., and some had clear spans of from 600 to 800 ft. Two lines, formed by four ropes fixed four feet apart, were provided for each system. The full buckets were pulled up one line, whilst the empties were simultaneously lowered on the other. The hauling ropes were about two inches in circumference and the fixed rail ropes four to five inches in circumference, which were chiefly composed of six strands of seven wires, hempen cores being used in the former, and wire hearts for the latter. The carriers of the buckets were mounted on four wheels of about 15 in. in diameter. Little or no attention was paid to the lubrication and preservation of ropes in these mines. In such climates a preparation of palm oil and soap might be advantageously employed, or other similar neutral lubricating mixtures with high melting points. Since the writer was at Kimberley in 1888, aerial ropeways are being rapidly replaced by inclined and vertical shafts.

An approximately uniform tensile value of all the wire used in the manufacture of any one rope should be insisted upon. Soft wire cores for strands and roping used in mining operations may in many instances be employed

in lieu of hemp with satisfactory results. Ropes composed of wires and strands laid in the same direction are more liable to spin, kink, and elongate, than those constructed according to the common principle. The amount of permanent stretching that occurs in roping may vary from, say, 1 to 2 per cent. of their lengths, dependent upon the construction, and angularity of lays adopted, as also the description of work to which the rope is applied. Mining ropes should be unwound from a turntable or revolving spool; a simple and cheap contrivance of the kind can be made by mounting an ordinary cart wheel upon a vertical axis. The comparative efficiency and durability of wire ropes supplied by different manufacturers can only be correctly estimated by the average performances of several of the same make under similar conditions of work. Not infrequently two or more ropes made from as nearly as possible similar wire and of the same construction will give widely different results. Manufacturers must admit this fact, however immaculate some may desire to be considered, and however obscure the cause of variation may be.

The construction and operation of street and other railways upon which vehicles are propelled by means of rope haulage afford an important field for the employment of superior kinds of wire roping. This branch of engineering covers, however, a large area of technical considerations and voluminous details to which the author has devoted a separate treatise.*

Upwards of 800 miles of street and other railways are now operated in the United States according to this system of traction. Over 100 miles are being similarly worked in the Australian colonies. The system possesses many permanent advantages where judiciously applied, and is capable of earning unparalleled dividends. In this country

* "Cable Traction as applied to the Working of Street and other Railways," *ENGINEERING*, London.

www.libtool.com.cn

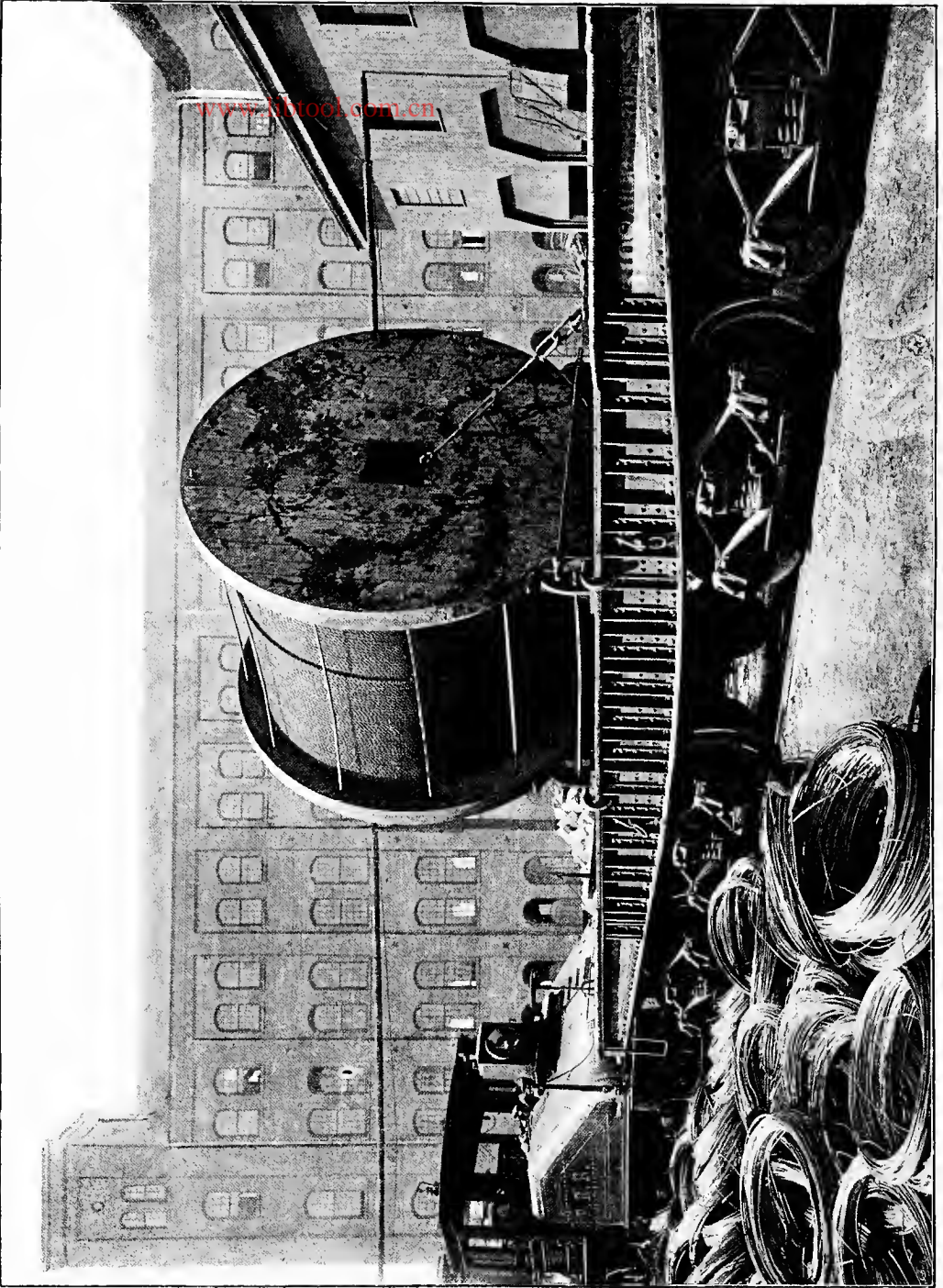

FIG. 55. RAILWAY WAGON FOR CONVEYING SPOOLS OF WIRE ROPE IN THE U.S.A.

“cable traction” has at present only found a very limited patronage in a few lines at Highgate, Birmingham, and Edinburgh, and, indeed, the lack of progress is not altogether surprising to those who recognise the common unsuitable condition of our thoroughfares, the cost of conversions and difficulties with existing lines, as well as those of insular prejudices and lethargy, combined with financial jobbery, which has largely paralysed *bonâ fide* enterprise. Of late electric traction appears to be the fashionable hobby, although there seems little if any tangible data at present to support its commercial success. Upwards of 1000 miles of electrical railways have been constructed in the United States, with various alleged results. Some give their cost of operation at 10 cents (5d.) per car mile, whilst others estimate 20 cents to be nearer the actual mark. The City & South London Underground Railway Company originally intended to work their traffic by rope haulage, but through influence electric propulsion superseded the scheme. After months of tedious delays and plausible excuses the line is at length opened. At the first shareholders’ meeting held last February (just when the line is a novel attraction) the directors had nothing definite to impart concerning the prospects of dividends or the cost of operations, the latter was, however, casually dismissed as “at present unascertained.”

The manufacture of long continuous lengths of wire roping in the United States for traction, &c., purposes has rendered special means of transportation advisable. Any methods of conveyance which necessitate intermediate uncoiling and recoiling of ropes are highly detrimental. The accompanying illustration, given at Fig. 55, represents a metallic bogie wagon such as used by Messrs. J. Roeblings, Sons & Co., for the railway transportation of large spools of wire roping. The picture is a reproduction of a photograph; in the background a portion of Messrs. Roeblings’

works may be seen. The coil of roping shown upon the 16-wheel bogie carriage contains 34,500 ft. of steel cable $1\frac{1}{4}$ in. in diameter, weighing 93,845 lb., as manufactured for the St. Louis Cable & Western Street Railway Company. The diameter of the flanges of the reel is 10 ft. $1\frac{1}{2}$ in., and the total height from the rail level 14 ft. $6\frac{1}{2}$ in. By this arrangement the ropes are coiled direct from the closing machines on to the transporting spools, and in this manner any intermediate handling of the rope is avoided. Messrs. Roeblings' works at Trenton are in direct communication with the Pennsylvania Railroad Company's system, through which any part of the States may be conveniently reached. Messrs. Roeblings' and the Trenton Iron Company's, &c., works are some 2800 miles distant from the Pacific coast, so that some idea may be gathered of the distances that manufacturers in that country may be required to convey their products. The cost of railway carriage in the United States is, however, more reasonable than in this country, *e.g.*, New York to Chicago about 30 cents per 100 lb.; similarly to Cincinnati, 25 cents; St. Louis, 35 cents; Kansas City, 55 cents; Denver, 1 dol. 30 cents; and San Francisco, some $1\frac{1}{2}$ dols. per 100 lb. These were recent rates, but in no country do the charges vary so rapidly or widely as in America.

Here it may be casually mentioned that Messrs. R. H. Wolff & Co., of New York, are stated to be turning out some creditable patent tempered rope, &c., wire.

The traction ropes used upon the New York and Brooklyn Bridge have exhibited some excellent performances. Take for example the first two cables employed, *viz.*, that put to work on the 7th October, 1883, and discarded on the 7th November, 1886, and the other used from the latter date to the 30th June, 1888. The first-mentioned rope worked for 1.125 days, during which period it travelled 226,273 miles and hauled 12,261,468 tons; the

second rope lasted a shorter time, but showed a still larger performance, viz., 13,720,795 tons conveyed. The last example demonstrates the great increase in traffic experienced upon the line, for whilst, during the first-named period 48,960,000 passengers were carried, the second rope transported only about 1,000,000 less persons in rather more than half the time. From these authentic records it does not appear that we have anything here to teach our American relations, whether in regard to the manufacture of servicable ropes or in their treatment during work.

The following tests and requirements exacted by the engineers of this line for the supply of the ropes in question are instructive: Diameter of wire used, 0.095 in. ; length of specimens tested, 60 in. ; breaking strength of specimens, 1200 lb. ; equivalent strength per square inch of section, 168,000 lb. = 75 tons ; elongation per cent. of length 5 per cent. According to other tests, lengths of 12 in. were experimented upon, in which cases the ultimate tensile strengths of the wires showed an increase, whilst the elongations were augmented from 7 to 9 per cent. of their lengths. The ropes were composed of the best steel wires of uniform quality, laid into strands of nineteen wires, six of which were closed round a tarred hempen centre to form a cable $1\frac{1}{2}$ in. in diameter. Each strand was about $\frac{1}{2}$ in. in diameter. The component wires were about $\frac{1}{16}$ in. in diameter, and withstood a strain of fully 1000 lb. each. The elongation of 12-in. specimens was not to be less than 4 per cent. The ends of the abutting wires in the strands were brazed together. The lay in the strands was about 3 in. whilst that in the rope was about 9 in. The weight of these cables was about $3\frac{1}{2}$ lb. per foot run, and their breaking strain not less than 50 tons. The ropes are run at a speed of about 10 miles per hour. The lubricant used was composed of vegetable tar and linseed oil. The stretch or ultimate elongation of these ropes has been about $1\frac{1}{2}$ per cent. of their

length. After the first cable was removed pieces of the same—in 23-ft. lengths—were submitted to tensile tests, the average ultimate resistance then being about 68,000 lb., or, say, about 30 tons. These statistics should be instructive to those interested in matters of cable haulage, and it is to be regretted that, so far, our applications of the endless cable system for working street or other railways can show nothing like the satisfactory results attained by our Transatlantic friends.

Fig. 56 illustrates a portion of the Forth Bridge during erection, showing the necessary hoisting and crane appliances previously referred to. The constructions of the various ropes employed in the erection of this colossal structure have been described in the preceding chapter.

Some twenty hoists, worked by wire ropes, for raising men and materials, were used during the erection of these unprecedented works. Ultimately wire roping was exclusively used on the various cranes with marked satisfaction. The hoisting ropes were 3 in. in circumference, having a breaking strain of 28 tons, although they were never taxed above three ton loads. The crane ropes averaged about $2\frac{1}{4}$ in. in circumference, and weighed about $3\frac{3}{4}$ lb. per fathom, whereas suitable hempen roping would have weighed 11 lb., or chains, 21 lb. per fathom for the same strength.

Fig. 57 represents the employment of wire ropes in the erection of the Sukkar Bridge, India, which is also built on the cantilever principle, the arms overhanging the river as indicated in the illustration. The form of construction and the situation rendered it necessary to erect the structure without the aid of much scaffolding, and therefore the assistance of wire roping was largely sought, and which was accordingly supplied by Messrs. Bullivant & Co.

Fig. 58 shows a rigged derrick in which wire roping is used for hoisting as well as the adjustment of the jib.

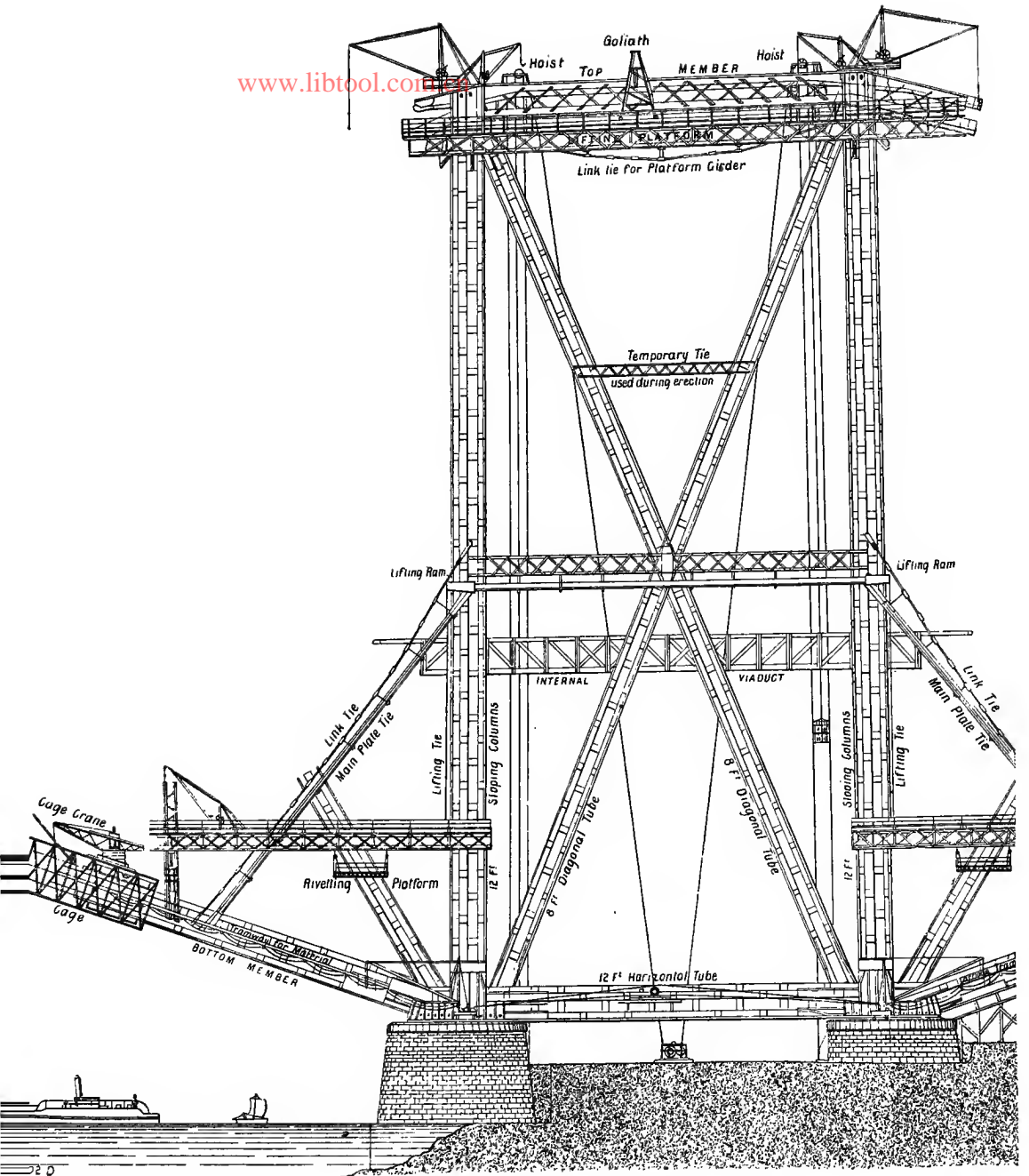
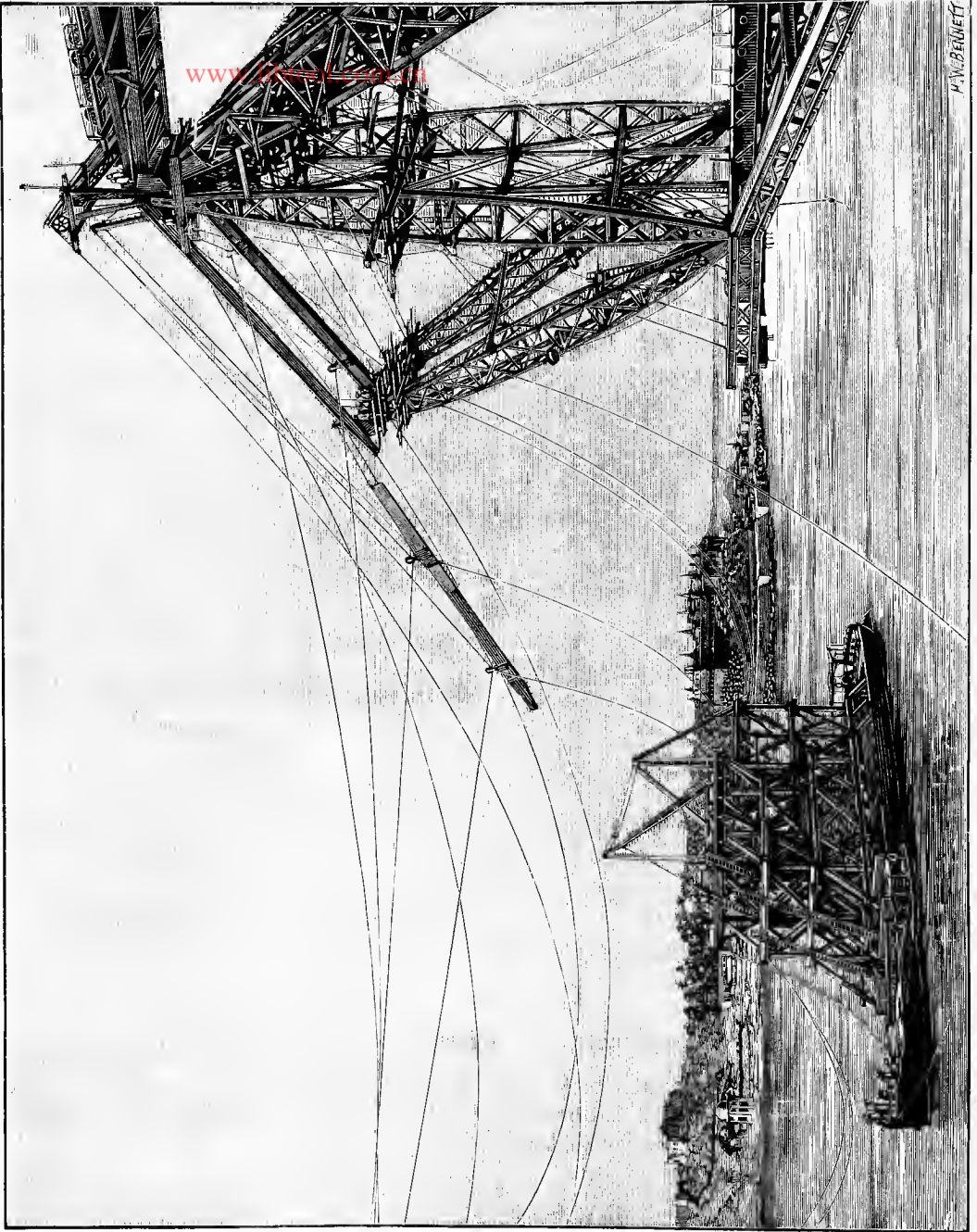

FIG. 56. ROPES USED IN THE ERECTION OF THE FORTH BRIDGE.



WWW.KALAMAZOO.COM

H.W. BENNETT

The rope B is passed over the pulleys C, and wound upon the drum D. The jib rope A is hauled in or run out by the hand winch shown in the illustration. The reverse bends inflicted upon the ropes is apparent. By employing the intermediate purchase or blocks, the spinning tendency of the hoisting rope is counteracted; in some cases, however, it is desirable to attach the lifting hook or gear direct to the rope in order to raise a load more rapidly.

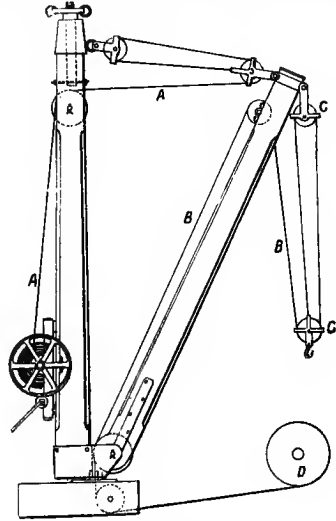

FIG. 58.

Examples of "sheerlegs," &c., worked by wire ropes may be seen at Messrs. Denny Brothers' shipbuilding yard at Dumbarton, or in the huge cranes of the "Titan and Goliath" built for the construction of the Peterhead Harbour of Refuge, and which are fitted with ropes of 5 in. circumference, each having a breaking strain of 80 tons. Again, the new 160 ton cranes in the Royal Dockyards worked with steel ropes 6 in. in circumference, and presenting an ultimate resistance of about 100 tons each, are further typical illustrations of the practical services rendered by wire roping. These hoisting appliances were

built by Messrs. Stothert & Pitt, and Messrs. Cowan & Sheldon respectively, whilst the wire ropes in all cases were furnished by Messrs. Bullivant & Co. The last-named firm have also supplied some very large ropes, *e.g.*, 9 in. to 12 in. in circumference for launching vessels, examples of which may be seen at the yard of Messrs. Day, Summers & Co., or upon the Ayr Slipway, &c. These ropes have been in use for the past ten years, and are reported to be still in good condition.

Steel wire ropes in place of chain cables have been advocated by Messrs. Bullivant & Co. for the last fifteen years, and the suggestion appears at last likely to receive some attention by our naval authorities, for the new cruisers building are to be equipped with anchoring ropes.

Lloyd's Regulations also now permit of merchant vessels being fitted on one side with anchoring hawsers, but the restrictions enforced by the Committee have greatly retarded their adoption.

Marine flexible roping may be produced by the employment of compound strands of, say, twenty-four to thirty-seven steel wires, but the usual hawser construction is six strands of twelve wires closed around a hempen heart. Referring to Lloyd's list of requirements for steam and sailing vessels, it is interesting to note that a ship of, say, 3000 tons has to be equipped with a 13-in. hempen or 4½-in. wire hawser, to obtain something like equivalent strength, the former weighing some 40 lb. and the latter 15 lb. per fathom.

Fig. 59 represents Messrs. Bullivant & Co.'s patent wire hawser "reel and nipper," as supplied to the leading European navies and mercantile vessels. Probably some readers will have noticed these appliances upon vessels of the Peninsula and Oriental, British India Steamship Company's, &c. These hawsers are employed for towing, mooring, warping, &c., purposes, they are only one-third

the weight of hempen ropes of equivalent strength, but are far more durable and cost only half the price of hemp or manilla. The ropes may be secured between the jaws of the nipping apparatus by turning the hand-wheel shown, which operates a powerful arrangement of toggle-lever mechanism.

By the employment of such a mechanical contrivance, "belaying" or fastening to hits, &c., is dispensed with, a process both slow and detrimental to metallic roping.

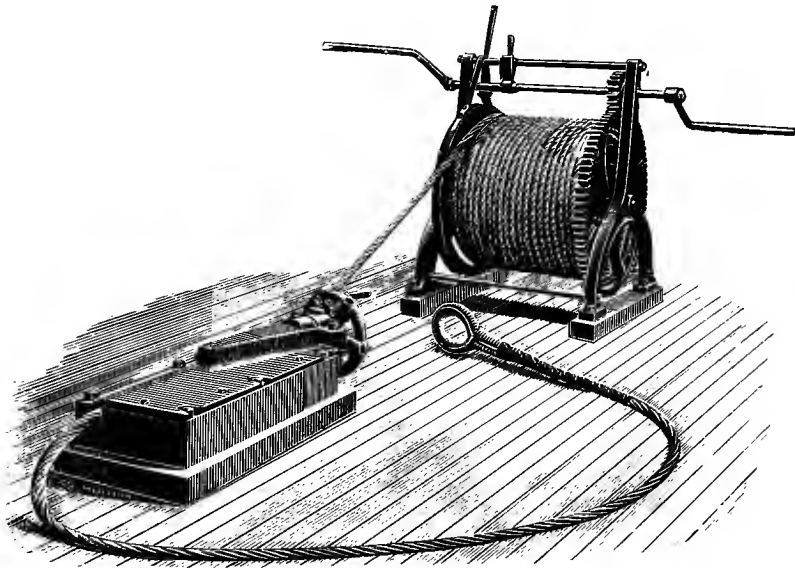
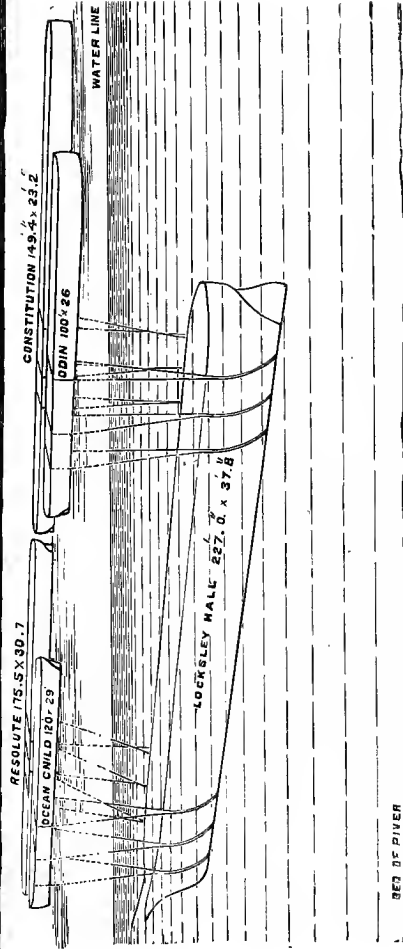
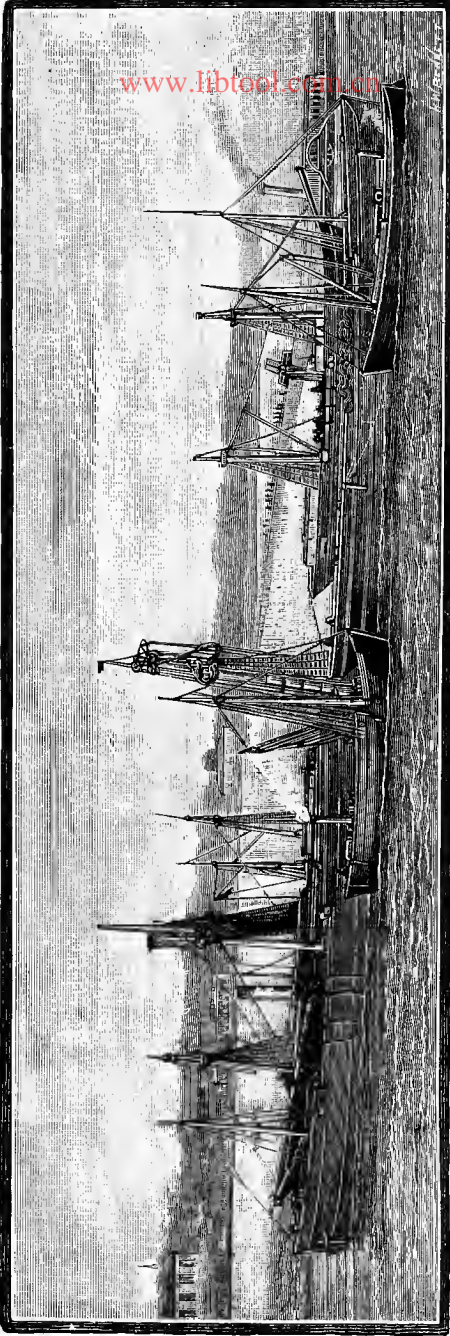

FIG. 59.

Another conspicuous instance of the useful service of wire roping was exemplified by the raising of the "Locksley Hall" during June, 1887. This vessel was sunk in the Mersey in February of this year, and on the 7th of May following Messrs. Bullivant & Co. signed a contract with the Mersey Dock and Harbour Board to raise and beach her. It was estimated that the deadweight to be lifted was about 2000 tons; and it is very creditable to record



DES. BY P. W. W. H. W.

FIG. 60. RAISING OF THE "LOCKSLEY HALL."

that, within six weeks from the date of the undertaking, they had provided all the necessary plant and special roping, and successfully accomplished their task, one previously criticised, by many should-be competent persons, as impractical if not ridiculous.

The vessel had foundered in the river from running foul of a steamer lying at anchor, and the wreck occupied such a position as to render navigation in the vicinity highly dangerous. The Mersey authorities at first determined to blow the ship up, but the Mersey Railway Company objected to such measures on account of the proximity of the wreck to a tunnel beneath the bed of the river. Under such circumstances the authorities advertised for tenders to lift the vessel. Some time, however, elapsed without reply, as the position and condition of the wreck were considered, by many experienced in such undertakings, to render the success of raising operations hopeless. Ultimately Messrs. Bullivant formed a combination with Messrs. Fletcher & Rennie, who undertook to lift the ship and carry it into shallow water for the sum of £15,000. The deadweight of the "Locksley Hall" was estimated at 1000 tons, and the cargo in her at about another 1000 tons. The four lifting hulks, shown in the illustration (Fig. 60), were capable of raising 500 tons each. The wire ropes used were 7 in. and 9 in. in circumference, the smaller size being made into strops, of lengths varying between 2 and 20 fathoms.

The larger ropes were composed of six strands of thirty-seven steel wires of about 100-ton quality. Bights of these main lifting ropes were passed, by the assistance of divers, under the wreck, and then hitched to the hulks by means of the strops. The deck of the sunken ship was 9 ft. below the river surface at low water. The hulks in rising with the tide carried the wreck off the rocky bottom on which she reposed, when the whole flotilla was towed by tugs into

shallow water. The bold adventure was crowned with success and proved a profitable stroke of business. The entire operations were carried out by Mr. C. Wood, of the Thames Conservancy, who has had the most successful experiences in this line of undertakings.

It was mainly owing to the enterprise of Messrs. Bullivant that cable traction for working street tramways was introduced into Great Britain.

Messrs. Bullivant have comparatively recently entered into a contract with the Hudson Suspension Bridge and New England Railway Company, U.S.A., for the supply of their suspension cables; the steel wires to be contained in such ropes are to have a tensile resistance equivalent to 100 tons per square inch of section. The bridge is to cross the Hudson River at Peekskill and have a main span of about 1620 ft., which is greater than that in the New York and Brooklyn Bridge, and within a few feet of that presented in the famous Forth structure.

The "telodynamic" system of transmitting power by wire ropes, and with the title and inauguration of which the name of G. A. Hirn is inseparable, affords a further example of the uses of wire in the form we are considering. Owing to the absence of suitable sites in this country for the utilisation of water power, the important illustrations of this application of wire ropes have to be mainly sought on the Continent and in America. At Schaffhausen about 1000 horse-power, generated by turbines, is transmitted by pulleys and ropes to various mills in the district. Some important telodynamic systems are about being erected at Niagara, U.S.A., for conveying power generated at the falls to neighbouring factories. Up to distances of over 1000 yards very economical results can usually be obtained. The loss of power occasioned by such method of transmission frequently does not exceed 1 per cent. per 100 yards. The system at issue costs about one-fourth that of belting and less than one-twentieth that of shafting.

The speeds at which the ropes are commonly driven range between 30 ft. and 80 ft. per second, the sizes of the ropes employed generally running from 1 in. to $2\frac{3}{4}$ in. in circumference.

Wire ropes in this application will be at once understood to fulfil the functions of belts for connecting the rotating elements of the system, and the power thus transmitted may obviously be augmented by increasing the adhesion on the pulleys and the velocity at which any rope is driven. In systems working over long distances the total estimated loss of power has only been about $2\frac{1}{2}$ per cent. plus 1 per cent. per 1000 yards of distance. The component wires of ropes employed in telodynamic operations are subjected to strains of extension and compression, and therefore comparatively mild grades of steel frequently give the best results. The standard horse-power transmitted is usually taken as 550 foot-pounds of work per second. The ratio of the tensions in the ropes on the tight and slack sides of the pulleys, due to the resistance to slipping, must be considered, as the resultant driving force is the difference of such strains. The catenary curves, which the ropes assume between the pulleys, form a mathematical basis for computing the tensions due to the distributed loads. The efficiency of work obviously varies according to the angles or planes of transmission. Driving pulleys should be employed that do not exert any lateral crushing action upon the ropes, the working peripheries of which are commonly packed with wood or leather. The pulleys used for the tight side of the ropes are usually about 12 ft. in diameter. On the Schauffhausen system the pulleys are placed from 330 ft. to 450 ft. apart, whilst the speed of the ropes is 61.8 ft. per second.

www.libtool.com.cn

CHAPTER VII.

WIRE NETTING AND WOVEN FABRICS, &c. ; THEIR MANUFACTURE AND USES.

THE wire netting industry was practically inaugurated about the year 1844, by the late Charles Barnard, who also founded the firm of Messrs. Barnard, Bishop & Barnard, of Norwich, in 1826. The manufacture was, however, at first very slow and primitive, as it was conducted by hand upon wooden rollers, but then the demand was also only very limited. The size of the mesh required to be produced was originally pegged out upon rollers, and the wires were twisted up by hand in a similar manner to that still employed for making some kinds of lattice work.

As the demand for wire netting increased Mr. Barnard soon appreciated that it was necessary to devise some mechanical means of production, and accordingly in 1855, we learn of this gentleman having invented a machine for its manufacture. At first the contrivance was driven by manual power, and although crude when criticised beside modern appliances, it was ingenious and effective in its day. Steam power was soon afterwards substituted for hand labour. Obviously the experiences of the past thirty-five years have resulted in improvements of various kinds, but Mr. Barnard is fairly entitled to the credit of having been the pioneer of the mechanical manufacture of wire netting.

This gentleman was further a recognised inventor of mangles, lawn mowers and other mechanical devices, and in association with which perhaps his name will be familiar to some readers.

The original netting machine may still be seen at Messrs. Barnard, Bishop, & Barnard's works, at Norwich, although, of course, it has been preserved as an historical relic and not for modern use. This machine was constructed to make a $1\frac{1}{8}$ -in. mesh. The firm has still amongst their employes four hand wire weavers who started with Mr. C. Barnard before the introduction of netting machinery.

Netting composed of small meshes, *e.g.*, $\frac{3}{8}$ -in. and $\frac{1}{2}$ -in., were until comparatively recently still made by hand, owing to difficulties remaining to be overcome in the mechanical manufacture. At present, however, all kinds of wire netting are made by machinery, the chief consumption of which is to be found in protective applications against ground game. Australian farmers and stock breeders are the wire netting manufacturers' best customers, indeed these colonists can apparently utilise any quantity of netting for guarding their lands against the rabbit pestilence, which has proved a terrible scourge. Wire netting was at first black varnished or "Japanned" and afterward galvanised to protect it against wet or atmospheric influences. Common annealed Bessemer iron or mild steel wire is usually employed in the manufacture at issue.

The following are the usual sizes of meshes and gauges of wire adopted in the manufacture of netting :

MESHES ...	$\frac{1}{2}$ in.	$\frac{3}{8}$ in.	$\frac{3}{4}$ in.	1 in.	$1\frac{1}{4}$ in.	$1\frac{1}{2}$ in.	$1\frac{3}{8}$ in.	2 in.	$2\frac{1}{4}$ in.	3 in.	4 in.
GAUGES ...	22	22	20	20	19	19	19	19	19	19	16
	20	20	19	19	18	18	18	18	18	18	15
		19	18	18	17	17	17	17	17	17	14
				17		16	16	16	16	16	13
					15	15	15	15	14	14	11
						14	14	14	13	13	10
									13	12	

The width of the netting may vary between 12 in. and

72 in., increasing usually by 6 in. stages. The meshes commonly range between $\frac{1}{2}$ in. and 3 in., but for special requirements they may be made up to 4 in., *e.g.*, sheep netting. The sizes of wire used similarly run from No. 22 S.W.G. to No. 14, but for special purposes it may be as stout as No. 12 or 10 gauge. The usual maximum width of wire netting is 6 ft., but Messrs. Bullivant & Co. manufacture up to 9-ft. widths, indeed, they were the first to advocate machines capable of producing such breadths. A 2-in. mesh is most sought in the home trade, whilst that of $1\frac{1}{2}$ in. or $1\frac{5}{8}$ in. is in most demand for export markets. On an average, wire netting runs from about 20 cwt. to 30 cwt. per mile, the average width being 3 ft. 6 in. In the home trade it is usually sold in 50-yard lengths, and for export in rolls of 100 yards, which are convenient for shipment. It is desirable that the latter should be more closely coiled than that required for home use.

According to American practice the meshes of netting usually range between $\frac{1}{2}$ in. and 2 in., composed of wires of 18 to 22 gauge, forming widths of from 24 in. to 72 in. It is sold there in rolls of 150-ft. lengths.

We will now briefly occupy ourselves with the examination of some modern types of wire netting machinery. Figs. 1 and 2 represent a front and back view of Messrs. Wilmott Bros.' latest designed machine, and which will be seen at a glance to be of compact and mechanical-like construction. The vertical parallel tubes shown in the first figure contain helices of closely-wound wire, and terminate at their upper extremities with semi-circular pinions. The second series of wires pass from off ground bobbins, situated at the back of the machine, through tubular spindles, also provided with semi-circular pinions. These half pinions are held in plates capable of sliding to and fro by means of a cam or eccentric motion

FIG. 1.

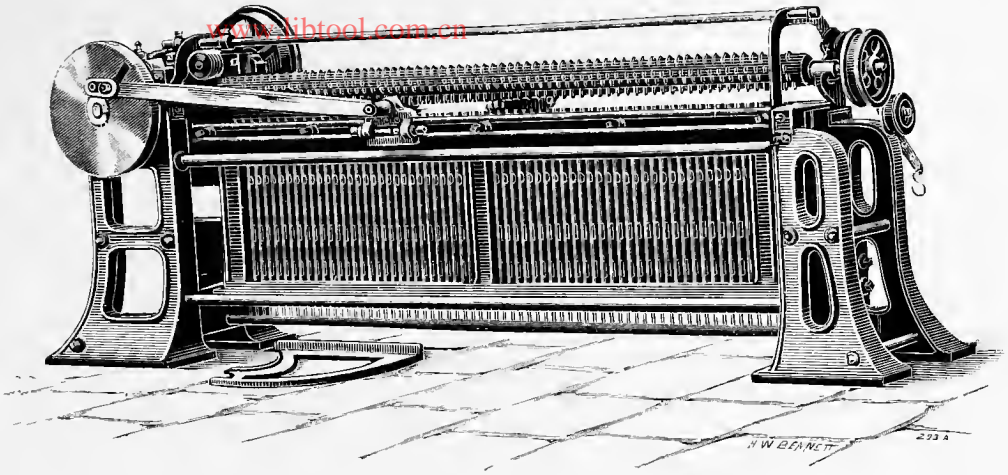
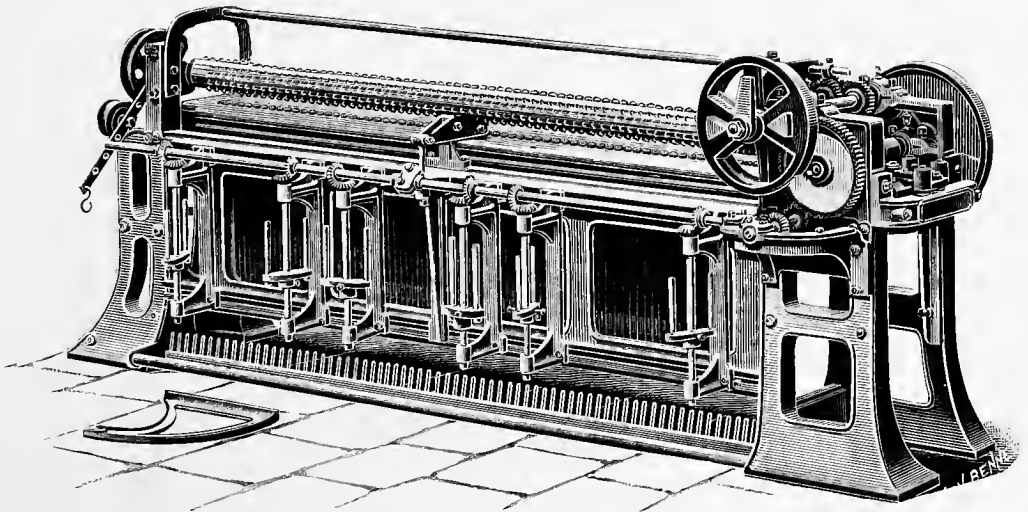

FIG. 2.



WILMOTT'S WIRE NETTING MACHINE.

www.libtool.com.cn

arranged at the head of the machine. The two series of semi-circular pinions, when in a coincident position, are also capable of being rotated by a reciprocating rack, actuated by the crank motion shown in the front elevation. The front wires, from the tubes and the back ones from the bobbins, traversing through their respective pinion heads, pass over the pegged horizontal barrel which controls the mesh to be produced, and further partially acts as a draw-off roller. It will now be understood that as the wires are drawn through the machine, the half pinions connected with the back wires are periodically slid to correspond with those on the front tubes by aid of the reciprocating plate, when they are jointly revolved by the rack motion so as to twist the wires. The mesh is then formed by the separation of the pinions which, in their turn, alternately rotate with the wires on either side of them. This change of "partners and right and left waltzing" motion will, however, be better understood upon reference to the diagrams given in Fig. 3. In position I the semi-pinions A B of the

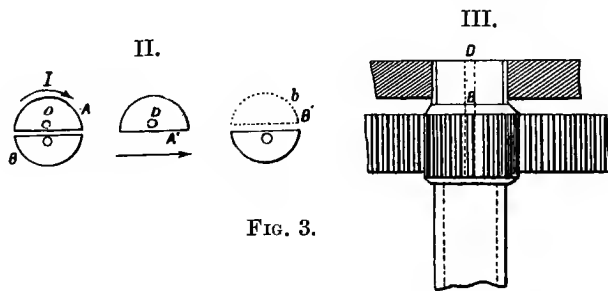

FIG. 3.

back and front wires are shown in their proper relations to be rotated, and consequently to twist, the wires passing through the small apertures D provided through the same. No. II. represents one half pinion and its wire, slid away to rotate with its neighbour.

The third diagram shows one of the pinion heads provided on the tubes, which when coincident with that of one

of the back series, is capable of being revolved by the rack teeth shown. Those half pinions not in gear with the rack are free to be moved laterally by the reciprocating top plate. Upon reference to Fig. 4 the resulting manufacture will be understood. The spiral portions E and F show where the back and front wires have been brought together and twisted as before explained, whilst the hexagonal mesh,

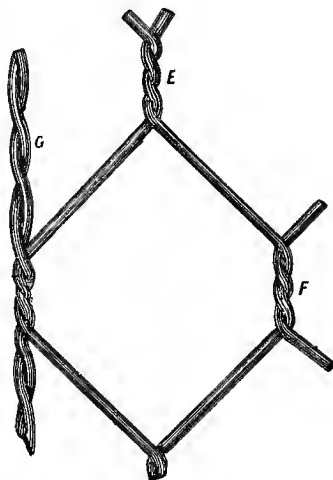

FIG. 4.

or open part forming the network, has been produced by the separation and lateral movement of the pinions so as to rotate with the adjacent wires of the parallel series. The illustration represents a portion of wire netting taken near the margin or selvage, composed of a stiffening strand G. In Wilmott's machines the selvage strand is simultaneously formed by the gear shown at the back of the machine, as the netting is being manufactured. The ground row of comb-shaped eyelet holes, shown in Fig. 2, are for guiding the wires from the bobbins to their respective rear pinion pieces. The crank motion for operating the rack is visible in Fig. 1, whilst the gearing for working the pinion plates,

www.libtool.com.cn

FIG. 5.

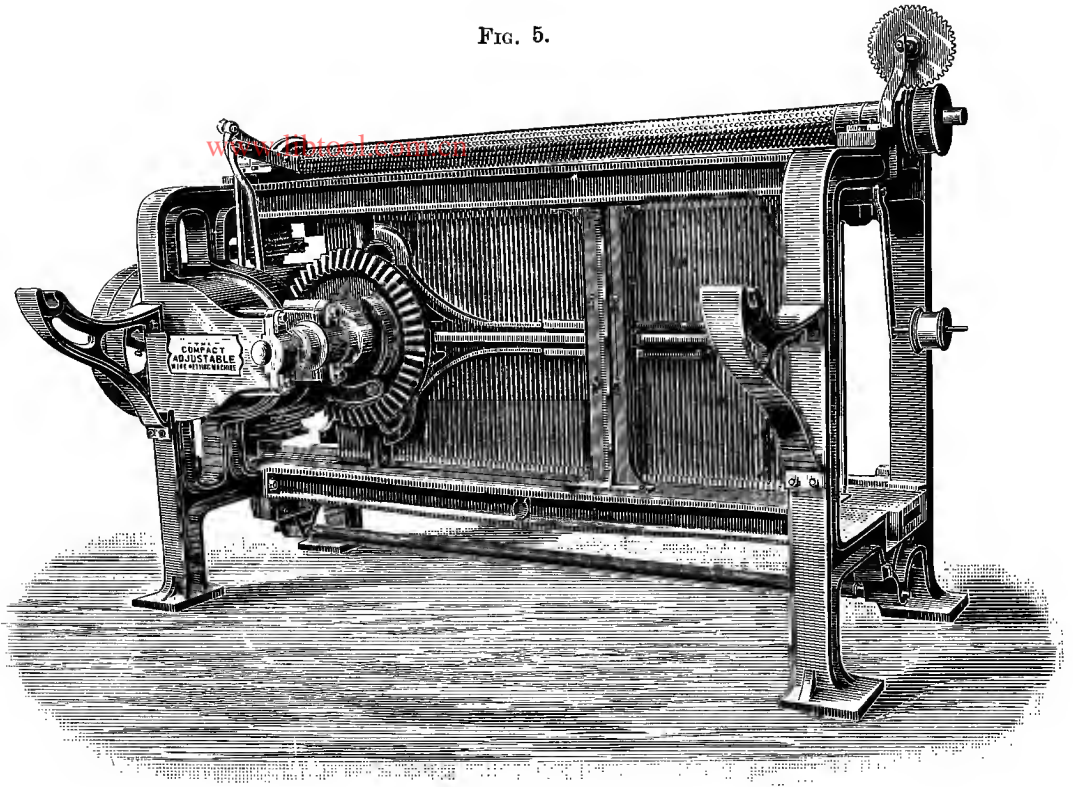
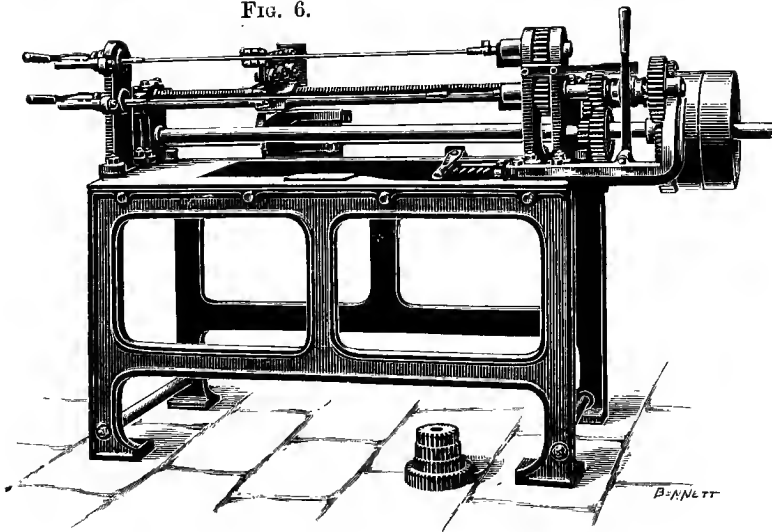

FIG. 6.



BOND'S WIRE NETTING AND SPRING COILING MACHINES

the "porcupine" roller and the selvage making mechanism, &c. are more clearly shown in the following figure. The movable parts of the machine are chiefly made of malleable iron, the shafting of steel, and bearings of phosphor bronze. The teeth on the rack and pinions are machine cut. Netting up to 10 ft. in width can be manufactured on these machines. The automatic combined selvage gear is fitted to machines from 1-in. mesh upwards, four selvages being required for the 6-ft. machines, and six for those capable of producing netting 10 ft. wide.

Fig. 5 illustrates a very similar type of wire netting machine as manufactured by E. S. Bond, of Birmingham. This class is used for producing $\frac{1}{4}$ -in. to 1-in. meshes, in widths up to 8 ft. The machine shown is of strong construction, and may be driven at a high speed, whilst all its working parts are capable of being readily adjusted. The special features of this machine are the means of operating the twisting pinions, whereby great power and speed of production are obtained, whilst the sliding plates and rack motions are capable of handy and accurate adjustment. The construction is claimed to be simple and efficacious.

Fig. 6 represents Bond's machine for "spring winding," or coiling the wire to be used in the netting tubes previously described, and which is capable of twisting up three helices at one operation. Any of the spindles may be independently stopped or started as required. The machine is capable of receiving "change wheels" suitable for winding different gauge wires, *e.g.*, from 14 to 22 S.W.G. It is fitted with automatic reversing gear and band-shifting mechanism. According to the improvements embodied in this apparatus, the spindles may be reversed for a few revolutions after the first coil or layer of wire is wound thereon, so that the same is enlarged in its diameter sufficiently to make it loose upon the spindle before the second or succeeding layers are wound upon the under coil or helices, thus permit-

ting the easy withdrawal of the spindle after the winding is completed. By this means the necessity of split collapsible casings or other devices hitherto used are avoided.

A device for supporting the spindles is provided at the particular points where the strain of coiling has a tendency to bend them, and by these means the use of a smaller and longer spindle is practicable.

The necessity of the attendant going to the back of the machine to adjust the stop which is provided for regulating the length of the coil is also obviated. Adjustable stops are provided upon the spindles, and whereby the end of the coil, at whatever point, is kept close up without chance of spreading during its reversal.

Wire netting is coiled up as it leaves the draw-off rollers of the machines, and in such form is then ready for the market. Until recently close rolling was effected by beating the netting down with wooden mallets during the process of winding. Figs. 7 and 8 represent a side elevation and plan of a machine for tight-rolling wire netting as invented and used by Messrs. Bullivant & Co. C is a spindle upon which the netting is wound, and is mounted in bearings and rotated at a variable speed as the netting is being coiled up. Above and below this shaft are two rollers or bearers *d*, which press against the roll of wire netting being wound. These rollers are forced against the netting by means of weighted levers D centred to the framing of the apparatus, or if desired springs may be employed instead of the said levers. The illustration represents the wire netting as being galvanised at B before being rolled. As the netting is being wound at C and the size of the roll increases, it is necessary, in order to subject the netting to the proper action of the galvanising bath, to decrease the rate of rotation so as to equalise the circumferential rate of the roll. To effect this variation an arrangement of speed cones E F are employed. The first

cone is driven by a band from the prime mover, and this drives the other one by means of a belt. The spindle on

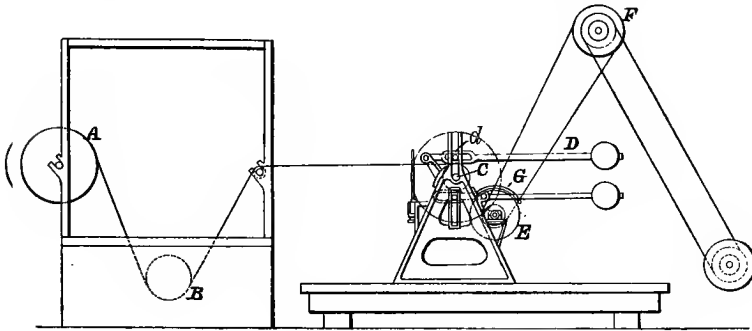

FIG. 7.

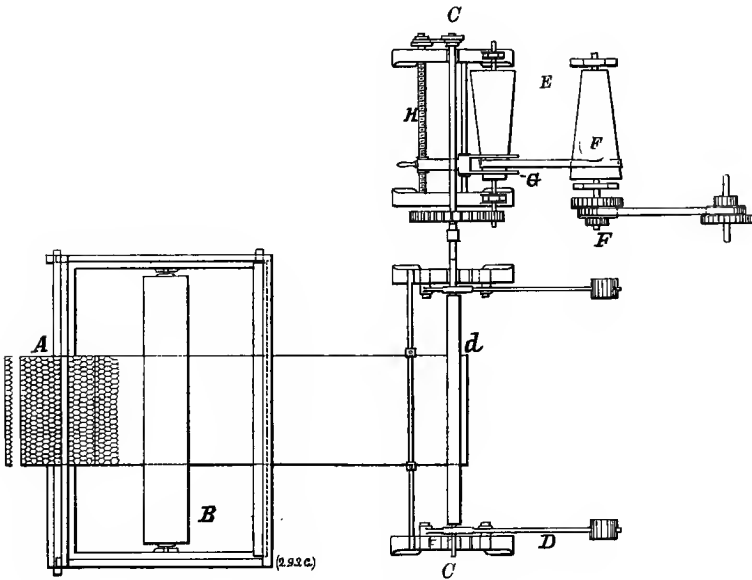

FIG. 8.

which the netting is wound is operated from the cone E by gearing. As the winding proceeds the band is

moved along the cones by the shifter G, from the large to the small diameter of the one cone and reversely on the other. This band-shifter may be operated as shown by means of a screw H, rotated from the spindle C, by means of a band and pulleys, at the required speed to impart to it the necessary motion to vary the speed of the spindle.

By properly proportioning the cones and the pitch of the screw, and adjusting the devices for driving the same, the apparatus can be arranged so that the netting shall be wound at a constant peripheral speed throughout the process, whilst the weighted or spring rollers, by pressing against the roll, will cause it to be wound compactly ready for shipment or transportation. In the manner above explained, the netting may be so closely rolled that "telescoping" or damage during transportation is almost impossible.

Fig. 9 represents an elevation of Dennis' patent continuous wire netting machine, the chief distinguishing feature in which (from all other existing types of apparatus) is that the whole of the wire used in the manufacture is supplied from bobbins or reels. In the ordinary type of machines as previously described one series of the wires necessary for the production of the netting is wound into closely coiled helices or "springs," which are inserted in the front metal tubes terminating with the "half pinions." Through these the wire is threaded to join the other series coming from the bobbins placed at the back of the machine. The diameter of these tubes, and therefore the amount of wire they can contain, is limited by the pitch of the pinions. As the latter is governed by the size of the mesh required to be made, it may be readily understood how small the quantity of wire is that can be placed within the tubes—even for the largest meshes. Much time and money have been spent in the endeavour to overcome this defect, but until the Dennis machine was invented no reasonable solution

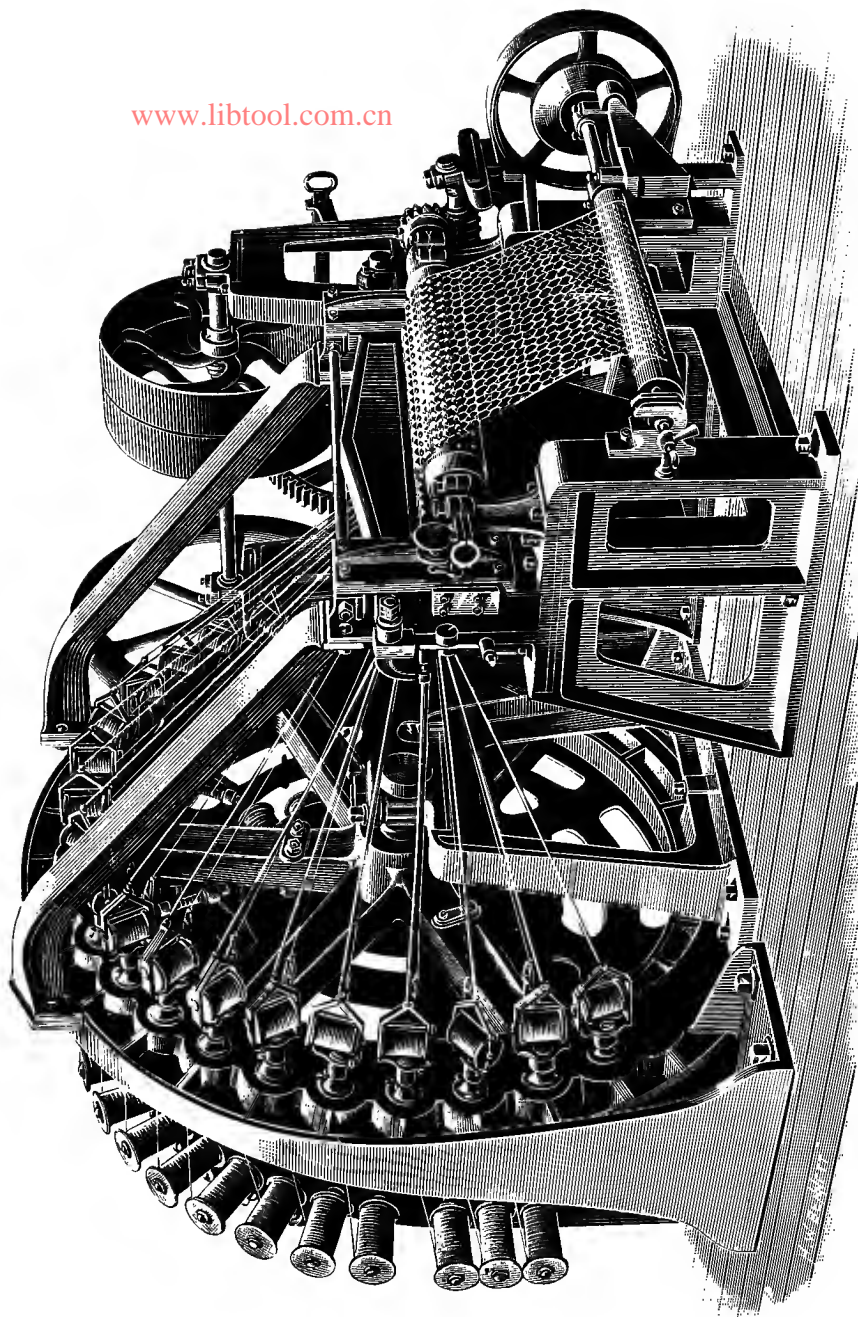

FIG. 9. PATENT CONTINUOUS WIRE NETTING MACHINE.

www.libtool.com.cn

had been presented. By the employment of a circular disc furnished with bobbins, holding from 3 lb. to 56 lb. of wire, according to the mesh of netting required, and by imparting to the same corresponding and simultaneous movements with those of the front plates, the objection mentioned has been surmounted and the waste of time consequent upon the frequent stoppages of ordinary machines, for the purpose of replenishing tubes with wire, is avoided. The bobbins provided on the Dennis machine hold a sufficient quantity of wire for one day's production of netting.

The machine is composed of four portions bolted down to a strong cast-iron bed-plate. Commencing from the back of the machine where the wire bobbins are situated, the following is a description of the component mechanism.

The bobbin stand is formed of a strong frame fitted with pins carrying one-half of the total number of reels necessary to make the required width of netting. Each of these bobbins is provided with special mechanism for keeping an equal tension upon the wire during the alternating movements of the machine.

The annular bobbin carrier or disc is mounted on a central steel shaft within a circular recess formed in the cast-iron frame, the periphery of the former and the inner surface of the latter being turned to fit accurately. Holes are bored in the disc and frame in such a manner that one half of the same are formed in the disc and the balance in the framing. These apertures are bushed with phosphor bronze and form the bearings for the pinions, which are made in halves and have an intermittent rotary motion imparted to them by means of a spurwheel at the back of the disc. One half of each pinion carries a "flyer," through which the wire is passed from the bobbins at the back of the frame. The corresponding half pinions are provided with frames

carrying bobbins, the number being the remaining half of the total number of spools necessary to make the required width of netting. Each of the disc bobbins is fitted with tension mechanism, hung eccentrically on the half pinion, so that its centre shall be exactly in line with the axis of rotation of the whole pinion, and whereby the wires are paired and maintained at a fixed distance apart.

The front plates are supported by standards 3 ft. to 4 ft. from the front of the disc, and are similar in construction to those in use on the ordinary types of netting machines; the holes therein are spaced according to the distances required for the production of the various meshes. The pinions working in the apertures are made in halves and are rotated intermittently by means of a rack motion. The wires from the disc bobbins and flyers are passed through the corresponding pinions in the front plates, and are then carried over by a pegged or "porcupine" roller to the "taking-off" apparatus of the machine, upon which the finished netting is rolled. The "porcupine" roller serves to form the meshes into the hexagonal shape seen in wire netting.

The driving mechanism is mounted on the standards and the speed is "geared down" from the main driving to an intermediate spindle and thence to the crankshaft.

By means of connecting rods the requisite movements are simultaneously imparted to the disc mechanism and that of the front plates. It is by this simultaneous movement of the disc and plates that the entanglement of the wires is prevented, and which would otherwise occur in the space between the same.

Assuming that the wires from the bobbins on the stand have been threaded through their half pinions in the disc, thence through the flyers and finally through the corresponding half pinions in the front plates, and that the wires from the bobbins on the disc pinions have been

similarly passed through the corresponding half pinions on the front plates, upon starting the machine the following alternating movements would take place. It will, however, only be necessary to describe the movements of the front plate mechanism, because that of the disc's is precisely similar. The pinions are caused to revolve three times by means of the rack motion, say from *right to left* or *vice versa*. On the completion of the third revolution, a lateral movement is given to the plates, whereby they are caused to traverse the exact distance of the pitch of the holes containing the pinions. By this movement the half pinions exchange partners and are then rotated by means of the rack three times from say *left to right* or in the opposite direction. The half pinions are then returned to their normal positions by a corresponding lateral movement of the plates, and are again rotated by the rack from right to left, and thus the cycle of operations is continued to form the various meshes composing the netting.

The borders of the netting are formed of a 2, 3, 5, or 7-ply strand, led from bobbins on the disc pinions through corresponding half pinions in the front plates, where it is worked into the netting, to form a strong twisted selvage. The machine is equipped with an improved measuring apparatus to record the production, and which indicates the completion of each 50 yards of netting rolled.

It is claimed that the quality of the netting produced according to Dennis' system of manufacture is superior to that made by machines commonly in use, the meshes being more regular and accurately shaped in consequence of the equal tension on the individual wires composing the fabrication.

It is also worthy of note that no spring winding machines are required with this system, so that there is an economy in space and a saving of coiling machinery, upon which

there is always wear and tear ; further, the waste of wire attendant upon the manufacture of wire netting is reduced, as the spring winding shop is considered the principal source of dissipation. Dennis' machine is claimed to be capable of working Bessemer steel as well as iron wire, so that smaller gauges may be used without loss of strength in the resultant structure, *e.g.*, No. 18 gauge netting composed of steel wire is equal in strength to that made of soft iron wire of No. 15 gauge.

Figs. 10 and 11 of the illustrations represent a self-acting steam-power wire-weaving machine recently taken in hand by E. S. Bond, before referred to. The machine is claimed to be capable of weaving either coarse or fine fabrics or webs, *e.g.*, from 2 to 100 meshes to the inch. It occupies but little space, and is entirely automatic in its actions. The loom only requires a female attendant, whilst its output is stated to be fully twice that of any hand weaving machine known in the trade. The usual solid warping beam is dispensed with, and a single spindle with lock screws and bobbins is substituted in its place. The motions of the machine are actuated by five distinct shafts provided with suitable gearing.

Figs. 10 and 11 represent a side view and plan of the loom in question, whilst Fig. 12 shows a detached view of the shuttle used in the machine.

The driving shaft *a* has a pinion on it, gearing into a tooth wheel on the counter-shaft *b*. Another pinion is keyed on to the upright spindle *d*, which has a duplicate at the other side of the machine, and these are geared to a horizontal shaft *G*. The vertical spindles are provided with cam plates *E* for actuating the "picker levers" *F*, which move the shuttle alternately from one side to the other. The shuttle is especially weighted according to the strength of the wire to be worked ; thus, whilst its momentum counteracts stiffness of the weft wires, its

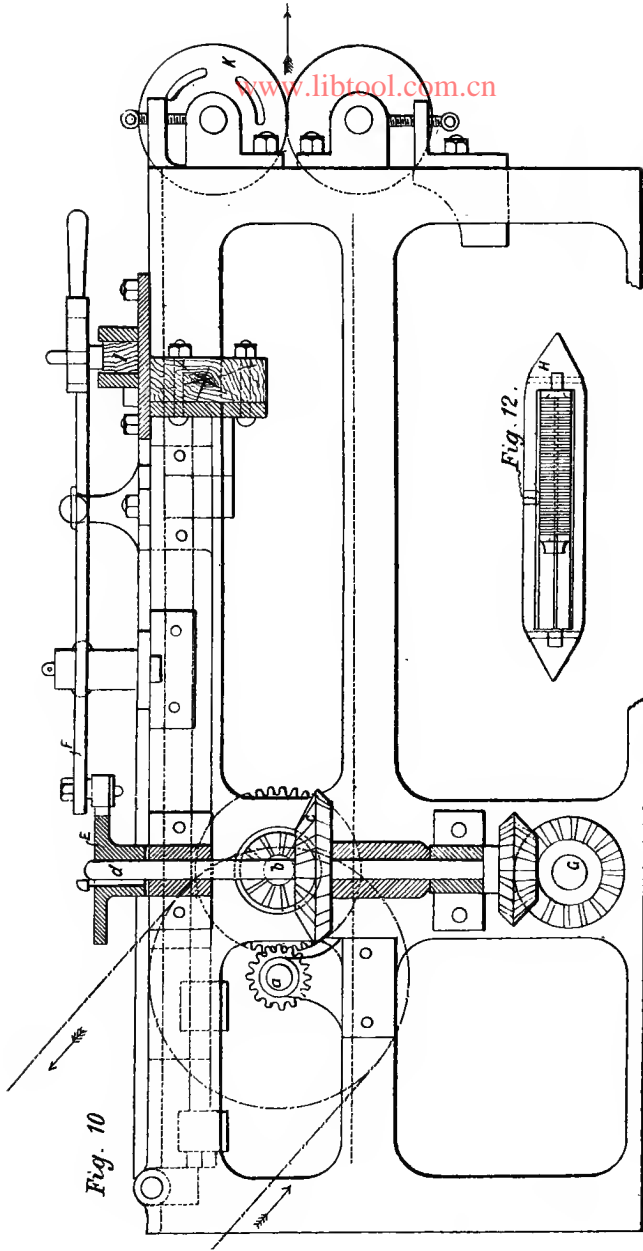

Fig. 10

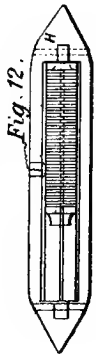

Fig. 12

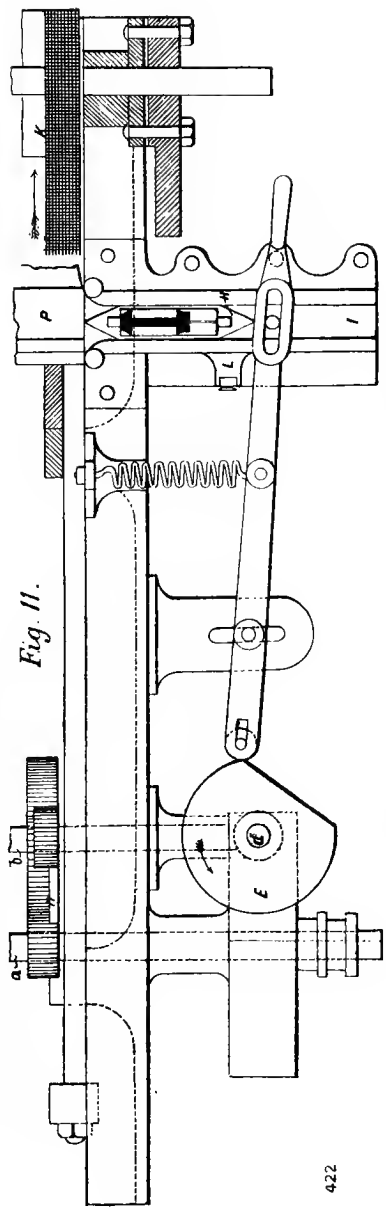

Fig. 11

gravity checks any sudden starting which might break the wire upon it, &c. The shuttle-trap I is formed of truly planed guides, within which the shuttle is held and controlled so as to bring up the slack of the weft wires before the "slayboard" pushes it home, the motion of which is derived from the shaft *b* and rods *J*. The first motion shaft returns the slayboard mechanism to its original position. A pair of rollers *k*, through which the woven web passes, is arranged as a "take-up motion," and which are placed in a direct line with the warp wires. When the warp requires replenishing the wires wound upon the large (tin-ended) bobbins mounted on the spindle are substituted for the warping beam. *L* is a sliding grip block in the shuttle-trap. As the levers *n* are operated they push up the slay *P*, which is afterwards returned by the reaction of a spring. One of the chief features in this power loom is the method of "picking" the wires in order to lay straight through the warp, and at the same time prevent the shuttle catching in the wires upon its return stroke.

Amongst the leading wire-weaving firms of this country the names of Johnson, Clapham, & Morris; Greening & Co., F. W. Potter & Co., Artingstall & Co., W. Riddle & Co., Wm. Mountain & Sons, &c., will be familiar to many. The first three mentioned firms are chiefly manufacturers of heavy or strong wire webs, whilst the last three are well-known weavers of fine wire gauzes and fabrics, such as used in paper and flour mills, &c. With reference to the latter class of webs the writer has before him some brass wire gauze which has 30,000 meshes or holes to the square inch.

Fig. 13 illustrates the construction of the torpedo nets now carried by most vessels in the European navies, and as invented and manufactured by Messrs. Bullivant & Co. The general features of this fabrication are described in the introduction to this volume. The netting is composed of

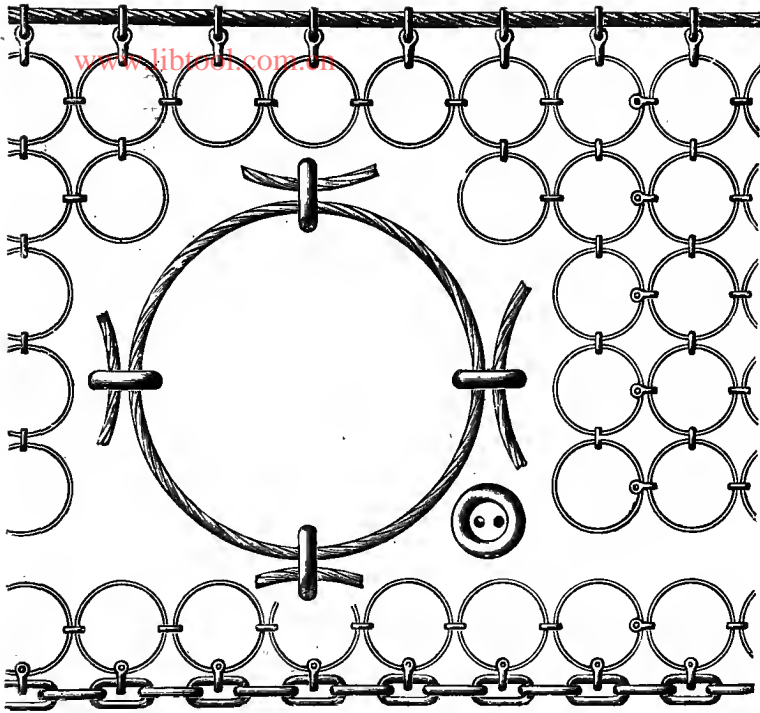

FIG. 13. TORPEDO NETTING.

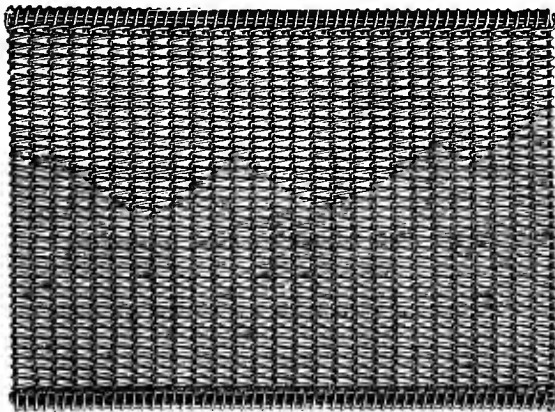

FIG. 14. SPIRAL INTERWOVEN MATTING.

hand-woven steel wire grummets connected together by wrought rings, as shown in the general and enlarged detached views of the accompanying illustrations.

Fig. 14 represents Messrs. Felten & Guilleaume's spiral wire matting, composed of a number of machine-made galvanised steel wire helices woven together and secured within a strong rigid frame as shown. These metallic mats are claimed to serve as scrapers and wipers and be self-cleaning. They are reversible, and obviously no shaking or beating is required to remove dirt, neither can they become saturated with wet. The construction is comparatively indestructible.

Wire of different gauges is also worked into straight or diagonal lattices for window guards, horticultural trellises, hurdles, railway gates, and numerous other similar applications, which space precludes from illustrating.

In America, wire woven fabrics are largely used in the manufacture of belting for driving purposes.

We will now make, that which may be considered by some, a digression from the title of this treatise, but as the invention and manufacture at issue have such direct and important interest to wireworkers, the writer believes that no further explanation is necessary for the incorporation. The matter in question relates to Mr. J. F. Golding's ingenious and useful invention of cutting or expanding sheet metal into lattice work suitable for lathing, fencing, and a variety of productions hitherto formed of wire at greater cost, and in some cases less suitable than the manufactures we are about to consider. Mr. Golding is a resident of Chicago, U.S.A., where his invention has been carried into practical effect for some time past, with considerable success. The British patents are invested in and worked by an English corporation, styled "The British Expansion Metal Company, Limited," having offices in London, and works at West Hartlepool.

The process of making this expanded metal consists in transforming a flat sheet or strip of metal into meshes, by an automatic slitting and expanding machine, which simultaneously slits a given number of strands in parallel lines with each other, opening the metal at these slits, giving set to the strands or shreds, causing them to retain the form and position so given, and leaving uncut spaces which serve to maintain the connection between each series of meshes so made. There is practically no limitation to the sizes of the meshes or width or thickness of the strands, these depending only on the size of the cutters and the strength of the machine. The simultaneous actions of the machine should be kept in mind, and the effects contrasted with a sheet of metal slit into strands and having uncut spaces breaking joint with the slits and afterwards opened up, as sometimes done with paper for ornamental purposes. It will be understood that a sheet of metal so slit could not be opened up on any one line of slits, as this involves end-wise contraction of the remainder of the sheet or else the stretching of the strands, and the last would only be possible with exceedingly ductile metals, such as copper or lead. Whereas a square sheet of steel having slits within it made in step form from one of its corners to the opposite diagonally, and in lines parallel with and overlapping each other, the metal on one side of these slits could be pressed away or deployed from the plane of the other side and still remain connected thereto by strands or shreds thus formed. This latter method is, in effect, the one employed in making "expanded metal," except that the cutting and opening is done at one and the same time, and is commenced at one corner and side of the metal, first one and then another series of meshes being made, until the whole sheet is consumed.

The nature of this ingenious invention will be, perhaps, better understood by considering an analogous result in

paper. On cutting slits in a sheet of paper and pulling the two ends apart, a mesh is produced in some respects similar to the article turned out by the method in question. As soon, however, as the ends of the paper are released, it will spring back into its original form, and which, of course, has to be avoided in expanding metal. The machine for carrying out this invention (see folding plate opposite), is therefore designed to cut and at the same time bend the strip into the shape which it is intended to retain. This operation is performed by means of upper and lower cutters between which the metal is clenched. The cutters are placed in a row one behind the other, and of the shape illustrated in Figs. 15 and 16. In the first figure the cutters are in position to receive the metallic strip A B, while in the latter they have approached and formed the meshes. The material commonly used in the manufacture is mild sheet steel of from 24 to 16 gauge thickness, and in strips about 4 in. to 8 in. wide and 9 ft. to 10 ft. long. According to the size of mesh this strip produces a lattice of from 2 ft. to 4 ft. wide, and only slightly shorter than the original length, e.g., $\frac{1}{16}$ to $\frac{1}{12}$. Fig. 17 shows one of these strips partly operated upon. The metal is fed into the machine from left to right at an angle parallel to the line *a b*, and the first stroke only produces one cut, the second two cuts and two diamond-shaped meshes, the third four, the next six, and so on. Samples of the finished lattice work are represented to a larger scale in Figs. 18 and 19, and from these the nature of the product will be understood and appreciated. The machine is provided with strong upper and lower jaws to which the cutters are attached; the upper ones move in a vertical plane by the action of eccentrics, two of which are fixed to the main shaft, worked from the driving spindle by means of gearing arranged on the left of the machine. These are attached by knuckle joints to the heavy casting, forming the upper jaw, as shown in the illustration. The

www.libtool.com.cn

Missing Page

www.libtool.com.cn

lower jaw is free to move longitudinally in guides, and since the edges of the cutters are bevelled, the lower ones are forced from right to left as the upper cutters descend upon them, thus clenching the metal between the inclined

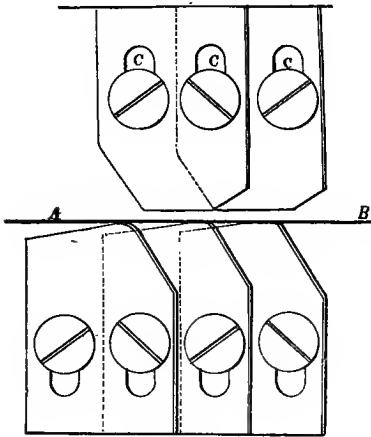

FIG. 15.

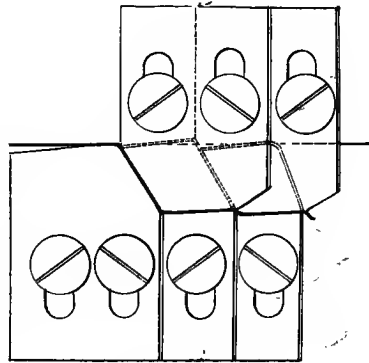

FIG. 16.

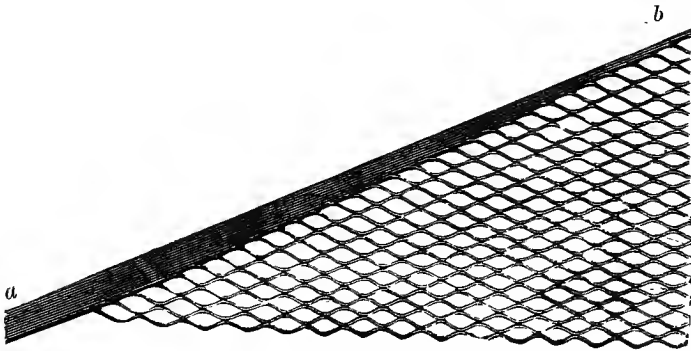

FIG. 17.

edges until after the upper jaw has been withdrawn. The large cam overhanging the shaft on the right brings the lower jaw with its cutters back again to its original position.

www.libtool.com.cn

The operations of the machine are entirely automatic, and the one illustrated turns out about 4000 linear feet per ten hours. The strips used in this case are 9 ft. long by 7 in. wide, and are transformed into a sheet of webbing with 4-in. meshes about 5 ft. wide and 8 ft. long. The speed of manufacture is at the rate of about 8 ft. per

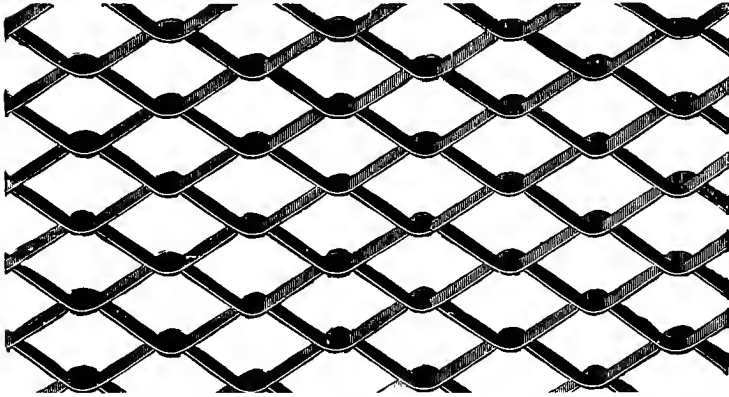

FIG. 18.

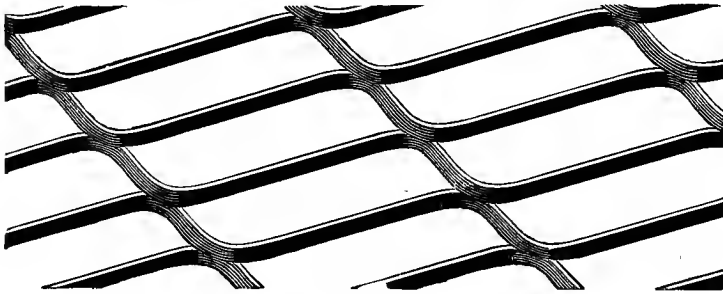

FIG. 19.

minute. For practical purposes it has been found desirable to have one stroke only on each machine, and employ separate machines for different sizes of mesh. Diamond shapes are produced from $1\frac{1}{4}$ in. to 4 in., and a very large quantity of this new material is being used as a substitute for wooden laths in lath-and-plaster walls, and for which purpose it is admirably adapted. A specimen of this production is

represented by Fig. 19. In this the spaces are small, and the metal being on edge offers an excellent key for the plaster, while the partition produced is practically fireproof. For the diamond-shaped mesh the greatest variety of applications have been, and are being, constantly found, one of its most general uses being that of fencing, for which purpose it is supplied from the works either dipped in paint or galvanised, and stiffened at the edges by angle irons or bars in a variety of ingenious ways. The manufacture is light, strong, durable, and of good appearance, and is sure to find admirers and customers. It is naturally very cheap to produce, and is adaptable for innumerable purposes.

In many branches of the wireworker's trade the manufacture described should find suitable and profitable application.

In the following chapter, on fencing materials, is illustrated one of Mr. Golding's standard fences or hurdles, as manufactured from expanded metal.

.

CHAPTER VIII.

WIRE FENCING MATERIALS AND THEIR APPENDAGES,
STAPLES, NAILS, AND SUNDRIES.

It is now proposed to briefly describe a few applications of wire to agricultural and other fencing purposes, and adjuncts relating thereto.

Wire fencing materials usually comprise plain or galvanised rolled or drawn iron and steel wires, ribbons, strands, or barbed wire stretched along wooden posts or metal uprights of suitable sections. Where woodwork is employed the fencing wires or strands are usually secured thereto by hooks or staples. In the use of barbed wire in this country caution should be directed to the position or application of such class of fencing, otherwise unintentional injury may be caused to animals, *e.g.*, horses or dogs, or the wool may be torn off sheep, and even human beings encounter serious harm. At first barb-wire fencing was considered by many as inhuman or cruel in principle, but later it has been recognised as a valuable medium for enclosing cattle and guarding landed property where judiciously applied. When first introduced only a very few tons were sold, whereas of late over a hundred thousand tons per annum have been manufactured in America and Europe.

Barbed fencing wire is an American invention. Some authorities, both at home and abroad, will not permit barbed wire being used adjoining public thoroughfares. Sometimes fences are constructed with bottom rows of plain wires or strands surmounted with barbed wire, and in this manner injury to dogs, &c., is avoided, whilst enclosed cattle would

be turned from it and persons prevented from climbing over the same. At home galvanised strand-fencing is largely used, but in the colonies cheap black varnished basic iron or steel wire is in the greatest demand, No. 8 S.W.G. being the average size employed. Naturally tenants of land are not desirous of adopting expensive forms of fencings, whereas superior protective measures may be advantageous to freeholders. Many thousand tons of plain varnished wire are now annually shipped to the Australian and New Zealand Colonies, mainly by German manufacturers, in coils of 1 cwt. each. Consumers prefer each bundle in one continuous piece, which, if of No. 8 gauge, would mean a length of about 565 yards. This class of

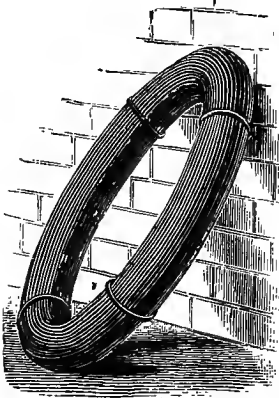

FIG. 1.

wire is cheap and very pliable, so that joints may be made with the fingers; on the other hand, much permanent elongation and buckling may take place, consequently a uniformly taut fence is impracticable for any length of time. Common basic iron or steel fencing wire is usually only drawn one hole after rolling; it is then annealed and coiled snugly upon specially-formed drums. The bundles are immersed in black varnish and suitably secured, as shown in Fig. 1. For facilitating transportation the hanks are wound so as to form pairs capable of fitting within each other.

Galvanised wire withstands wet weather better than that which is simply varnished; it can also be seen better, but the cost is slightly greater.

Where wooden posts or uprights are used the wires are commonly secured thereto by staples (Fig. 2), which may be had chisel or diamond pointed according to requirement.

Staples are usually shipped in bags or kegs, whilst the wire may be exported without packing at the merchant's risk, or be wrapped in canvas or stowed in casks for an extra payment of a few shillings per ton. This class of fencing wire, as supplied by German manufacturers, is as a rule better coiled and of superior appearance to that furnished by English makers; it is, however, true that the markets are so overstocked with common grades of fencing wire that the trade is scarcely worth having.



Of late, several manufacturers have been advocating superior qualities of steel fencing wire, of from 50 to 70 tons breaking strain per square inch, as a substitute for annealed iron or soft steel wire before referred to. Although, in such cases, the prices per ton are higher than for common grades, yet the cost per mile may be even less, for it will be readily understood that smaller gauges of superior steel wire may be employed for the same tensile strengths. Further, the limit of elasticity is greatly increased, and whereby a more taut and sightly system of fencing is obtainable.

With the common qualities of wire tightening up has to be frequently resorted to, and even then buckling sinuosities are often to be seen. The value of these remarks will perhaps be better understood by some practical comparisons with materials actually in the market, therefore let us, by way of example, pause to examine the properties presented in a common annealed iron or steel fencing wire of No. 8 S.W.G. against those of a special steel fencing wire of 50-ton quality and No. 11 gauge, as manufactured by Messrs. Felten & Guilleaume. In the first case the common No. 8 gauge wire may average a length of some 550 yards to the hundredweight, and have a breaking strain of about 1140 lb., whilst permanent elongation will

commence at a strain of some 450 lb., and which may attain some 15 per cent. at its point of rupture. In the latter case the No. 11 special steel wire would run about 1010 yards per hundredweight, with a breaking strain of, say, 1200 lb. permanent elongation commencing at about 780 lb., which up to time of rupture would not exceed 7 per cent. of its length. Further, the comparative prices per mile of wire are in favour of the employment of that composed of superior steel. Some still higher grades of steel fencing wire may not exhibit signs of permanent stretching under a strain of 900 lb., and then only equal some 4 per cent. of its length at its ultimate tensile resistance. Objections have been raised against the employment of finer wires of equal strengths, as in the example at issue, on account of their being less easily seen, but this, after all, is more an imaginary weakness than a valid impeachment. However, such source of difficulty or demur may be readily overcome by employing a two-ply galvanised steel strand, which would be more visible than either case previously cited, and yet cost no more per mile. Reverting to the properties of the common fencing wire of the size above specified, and substituting therefor a two-ply strand, composed of two wires of 75-ton quality and No. 10 S. W. G., a breaking strain of 1060 lb. would be presented with an ultimate maximum elongation of only 4 per cent. These superior grades of steel fencing wires and strands have been largely adopted in South America with satisfactory results. In the case of the two-ply strand just mentioned, 1700 yards go to the hundredweight, and in all cases the price per mile is in favour of superior qualities of steel fencing, independently of any consideration of the inferior properties of annealed iron or basic steel wires.

Fencing wires may also be drawn of oval section, so that one position presents more surface to view.

Some manufacturers supply galvanised or varnish spiral

fencing ribbons and corrugated cylindrical wires, but comparatively they are in little demand.

Barbed fencing wire is usually composed of No. 12 or 14 S. W. G., having two or four barbs twisted around one or both wires, about three or six inches apart, as represented in Fig. 3. The usual styles supplied, viz., 2 and 4, "open" barbed and "thick-set," run approximately 570 to 530 yards and 530 to 450 yards respectively per hundredweight. The wire is usually galvanised and sold in reels weighing from $\frac{1}{2}$ cwt. to 1 cwt. each.

The original patents for the manufacture of barbed fencing wire are the property of Messrs. Washburn & Moen, Mass., U.S.A., and by whom licenses have been granted to Messrs. R. Johnson & Nephew, and Messrs. Felten & Guilleaume for the sole manufacture in Great Britain and Europe respectively.

Without question barbed wire forms the most effective metallic fencing yet devised for resisting trespassers or the attacks of cattle; but, on the other hand, some time will doubtless elapse before European authorities will allow it to be indiscriminately used, although manufacturers may cite drastic decisions in its favour as valuable ornaments to trade circulars. Our American friends

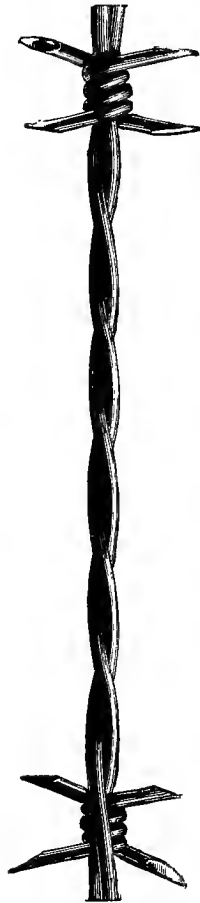

FIG. 3.

may run locomotives and trains through their public highways and darken their sky with a plexus of electric traction and lighting, &c., wires, charged with currents of some 500 to 1000 volts, but still, such proceed-

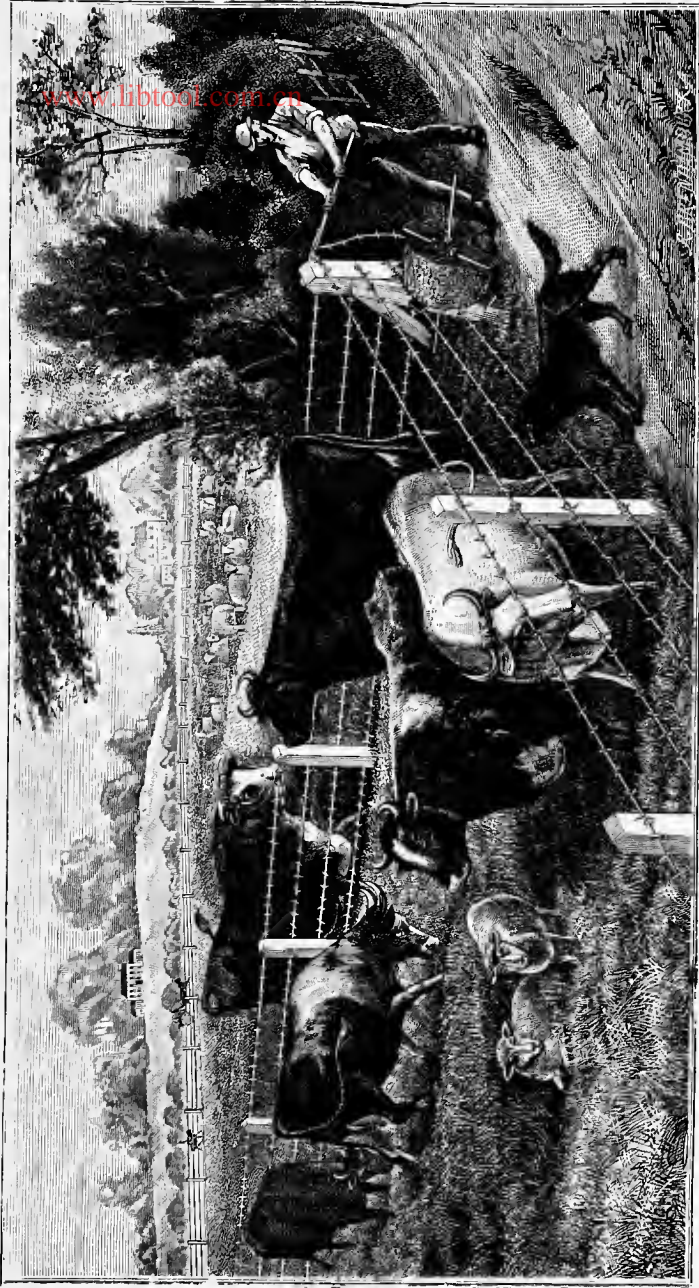

FIG. 4. BARBED WIRE ENCLOSURE.

ings would hardly suit our requirements and crowded thoroughfares. Similarly, although barb-wire fencing is admirably adapted to the protection of landed property, and for enclosing live stock, in a large portion of the States or our colonies, &c., nevertheless we should scarcely be pleased to see it applied to our parks or promiscuously along our public roads, &c.

As the original barb-wire patents shortly expire, doubtless its manufacture will soon be taken up broadcast and the markets become glutted with such products. During

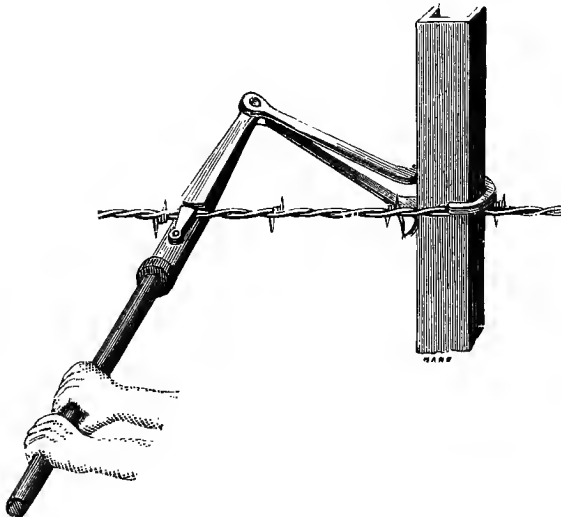

FIG. 5.

the last few years the manufacture in question has been a very lucrative business, as it has been confined to a few, but shortly it will be probably as much mutilated as the ordinary fencing wire and netting trades, &c.

Fig. 4 represents a cattle enclosure composed of a parallel series of barb-wire secured to wooden posts by means of common staples as previously explained.

In this view a man is represented in the act of completing a portion of the fence and straining the top

wire taut by means of a hand-lever and pincers, shown in a detached view at Fig. 5; after this the wire is fixed in position by staples. The vice and wrench appliance used for making joints in barbed wire is illustrated by Fig. 6, and which completes the list of special tools necessary for promptly and efficiently erecting this

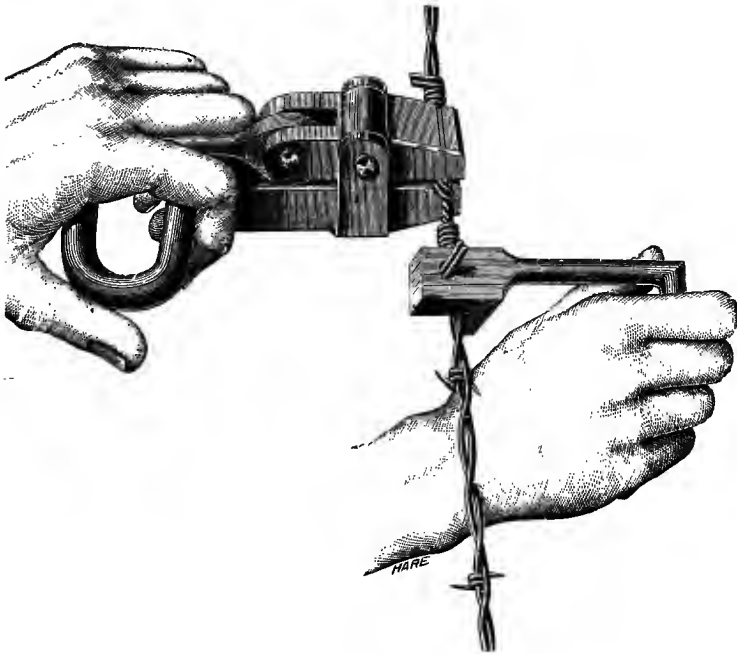

FIG. 6.

type of fencing. These, with other similar requisites, may be obtained from Messrs. Dennis & Co., London.

The Figs. 7 and 8 represent the employment of barbed wire in combination with plain wire and netting secured to metal standards, for specific fencing purposes, and as supplied by Messrs. G. B. Smith & Co., of Glasgow.

Another application of barbed wire is illustrated by Fig. 9, and in which it is employed in the construction of

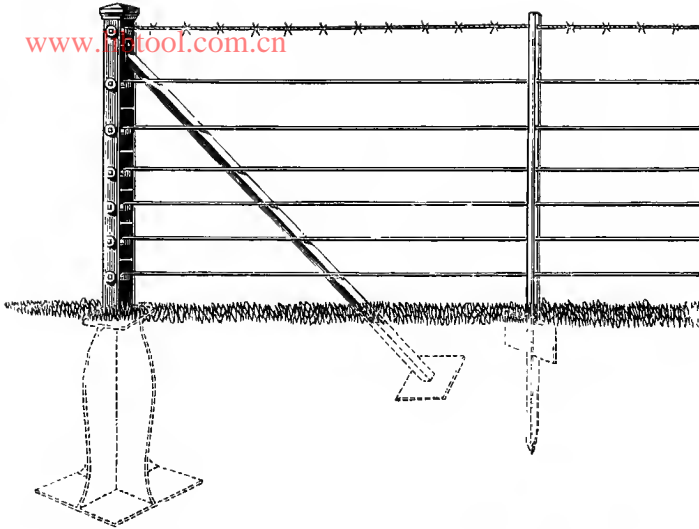

FIG. 7. STRAINED PLAIN AND BARBED WIRE FENCE.

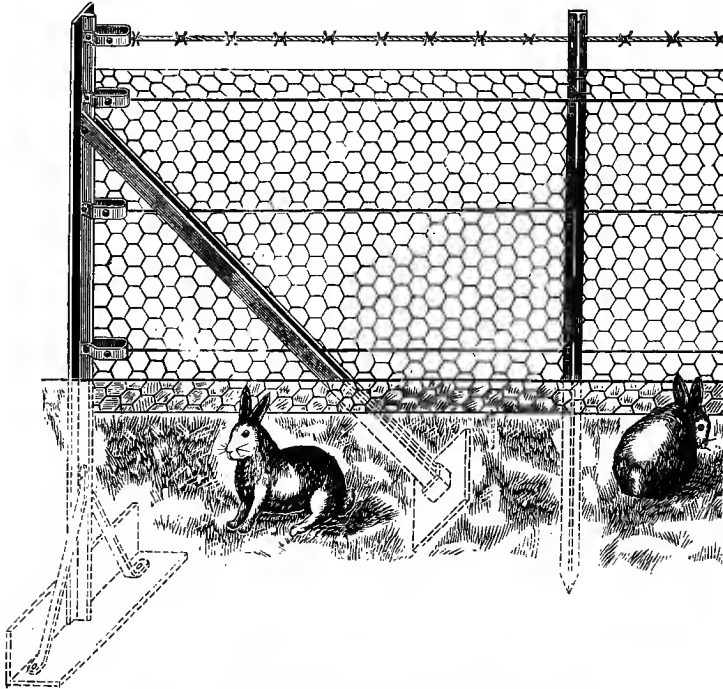

FIG. 8. BARBED WIRE AND NETTING FENCE.

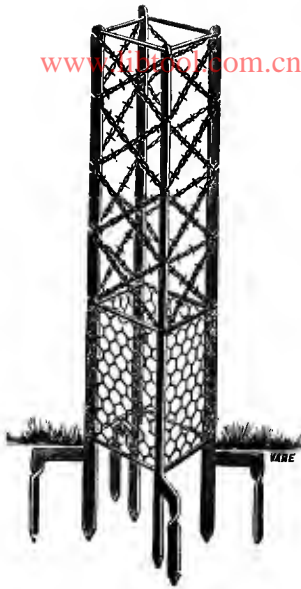

FIG. 9.

guards for preventing animals, &c., from "barking" or injuring trees and shrubs, and at the same time resist rabbits or small game, &c., by aid of the ground border of wire netting. These so-termed "Porcupine Tree-guards" are the invention of Messrs. Hill & Smith, of Brierley Hill.

Returning to the consideration of fences composed of plain and stranded wires, different typical designs, as supplied by Messrs. Hill & Smith and G. B. Smith & Co., &c., are illustrated in Figs. 10 to 13 inclusive.

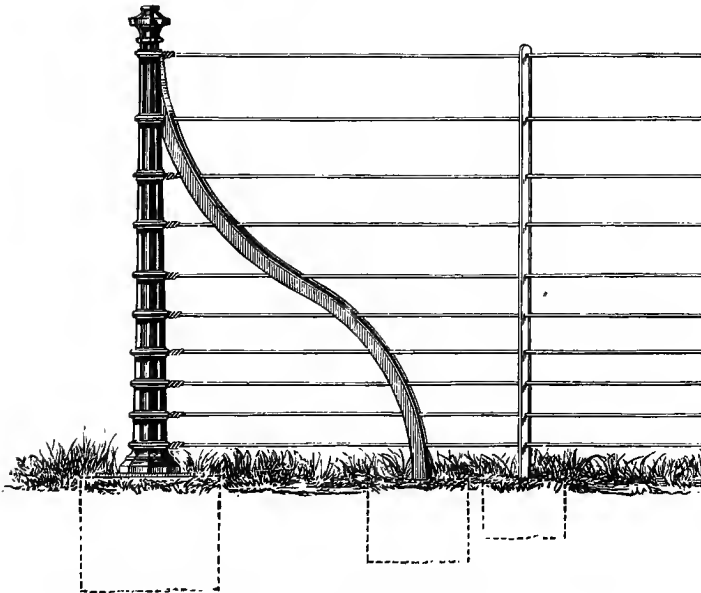

FIG. 10. PARK WIRE FENCING.

Galvanised iron or steel strands employed for fencing purposes are usually composed of seven small wires, and whereby great pliability is obtained, but a less number of wires are adopted for some classes of strands, *e.g.*, two to five. The following Table gives the approximate lengths and weights of solid fencing wire as compared with 7-ply strands composed of different sized wires :

Gauge.		Length of 1 cwt. (112 lb.)			Weight of 1 mile (1760 yards).			Gauge.
		Steel Wire.	Iron Wire.	Galvanised 7-Ply Strand.	Steel Wire.	Iron Wire.	Galvanised 7-Ply Strand.	
No.	yards.	yards.	yards.	lb.	lb.	lb.	No.	
1	159	161	200	1245	1227	987	1	
2	190	193	226	1037	1022	873	2	
3	229	232	260	863	851	759	3	
4	272	276	307	724	714	645	4	
5	328	332	392	604	595	504	5	
6	390	397	465	502	495	425	6	
7	471	479	546	418	412	361	7	
8	565	573	699	350	344	283	8	
9	670	680	800	294	290	247	9	
10	807	819	1000	244	241	198	10	

Fig. 10 illustrates a type of wire fencing suitable for enclosing deer forests or parks ; it extends 6 ft. above the ground and is composed of ten lines of parallel horizontal wires of from, say, 6 to 8 S.W.G. The wrought-iron standards and straining pillars are placed 8 ft. apart, with sections of $1\frac{1}{2}$ in. by $\frac{3}{8}$ in. and $1\frac{3}{4}$ in. square respectively. The straining and winding pillars are situated about 100 yards apart. All these uprights are designed to be secured in stone foundations as indicated in the illustration. A similar class of fencing, carried, say, 3 ft. 6 in. high, would serve for enclosing sheep and light cattle ; and if of stronger proportions, for heavy live stock. The end or corner straining pillars are strengthened in this case by curved stay pieces.

Fig. 11 represents a strained wire and game-proof fence

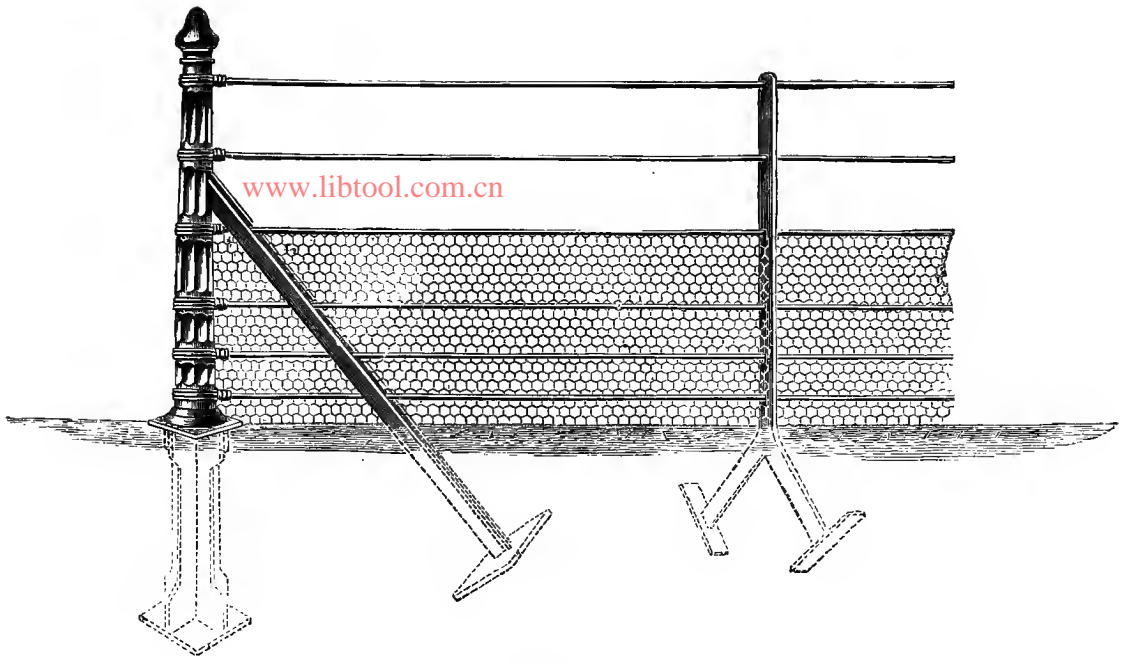

www.libtool.com.cn

FIG. 11.

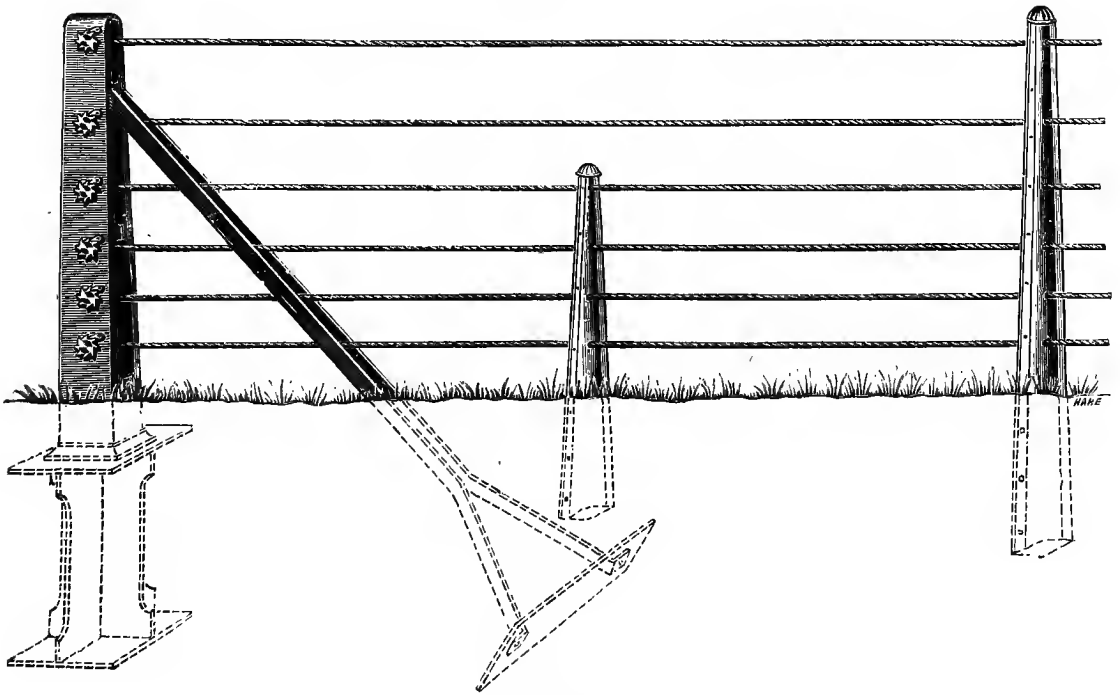

FIG. 12.

STRAINED WIRE AND STRAND CATTLE FENCING.

for enclosing oxen, it is 4 ft. high, and composed of standards $1\frac{1}{4}$ in. by $\frac{3}{8}$ in. placed 8 ft. apart. The wires are strained from ornamental cast-iron pillars situated 100 yds. apart, with diagonal strengthening stays; additional supports are used on curves or over very undulating ground.

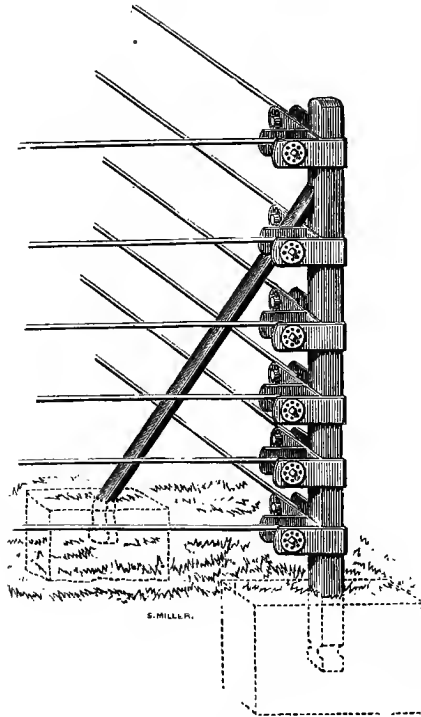

FIG. 13.

Fig. 12 illustrates a strongly designed galvanised strand fence, consisting of substantial straining pillars placed 200 yards apart with galvanised sheet-iron standards spaced at 15 ft., and carried 2 ft. above the ground. The strands are composed of seven galvanised wires. The pawl and ratchet straining mechanism attached to the pillars are shown in the engraving.

A form of angle-straining pillar with double winders is shown in Fig. 13. This type of fencing is designed for *batting* to stone or concrete, whilst the winders are capable of straining lengths of wire up to 300 ft. It will be readily understood that the pillars and intermediate standards may be of various sections and constructions according to taste and requirements, but a popular form for the latter supports is of bulb-tee iron section about $1\frac{1}{2}$ in. wide, such as represented in Fig. 14. For some lighter descriptions of fencing, angle iron uprights of about $1\frac{1}{2}$ in. by $1\frac{1}{2}$ in. by $\frac{1}{4}$ in. section are extensively employed.

Figs. 15 and 16 illustrate ratchet winding or tightening appliances used for wire fences in which the posts or supports are composed of wood. The first arrangement works in a vertical, and the second in a horizontal, plane.

Fig. 16 might also be applied to metallic standards as a strainer of convenient design, and in both cases they are sold either galvanised or coated with protective varnish.

Figs. 17 and 18 show views of angle iron "droppers" as employed in Smith's "corrimony" fencing—a system largely used in Scotland and other mountainous districts. These "droppers" are commonly placed every 6 yards apart, say three between the standards fixed in the ground 24 yards apart; they serve to keep the strained wires in their proper parallel relations, and not being carried into the ground (but merely resting on the surface), a more flexible structure is obtained. One method of holding the wires to these spacing pieces is represented above, and will be seen to consist in the employment of steel clips, which embrace the wires and then pass through the apertures cut in the angle irons, as shown in the illustrations.

It will usually be found more economical to have all fencing, materials galvanised; varnishing every two or three years generally proves more expensive and not so effectual.

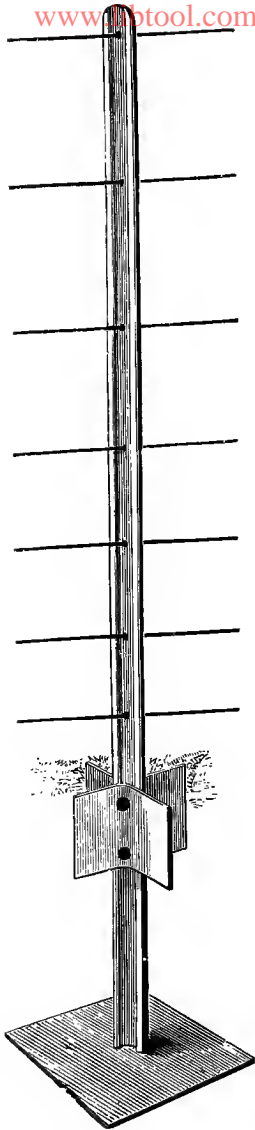

FIG. 14.

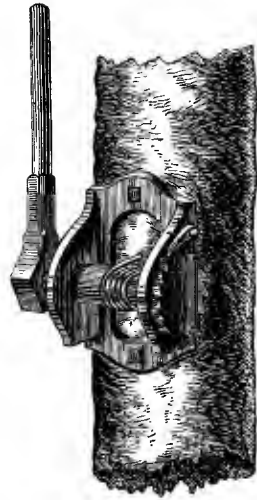

FIG. 15.

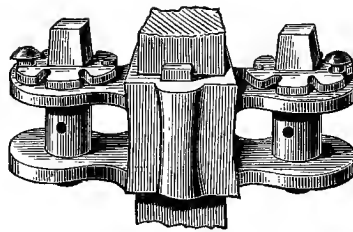

FIG. 16.

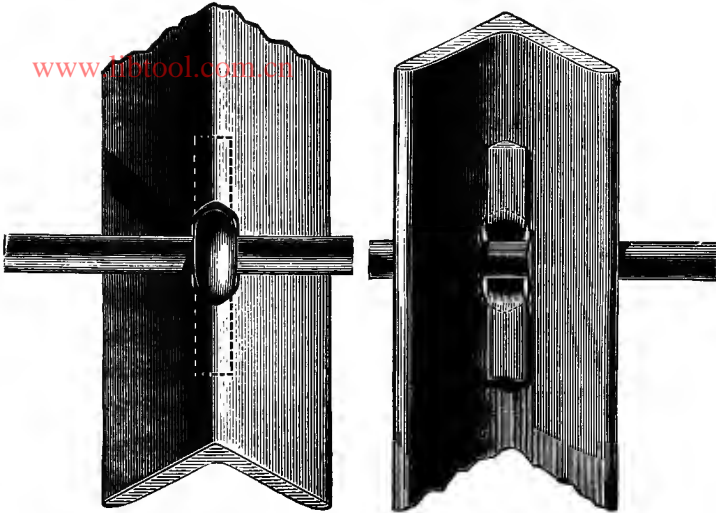

FIG. 17.

FIG. 18.

Fig. 19 represents a strained wire "espalier" fence for training trees or shrubs, &c.

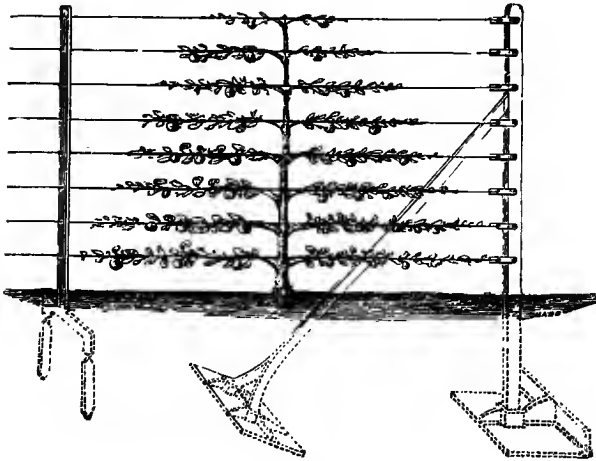

FIG. 19.

On page 328 are illustrated Messrs. Hill & Smith's tools advocated for the prompt and efficient erection of strained wire fences, the following descriptive numbers having reference to the figures given on the page referred to

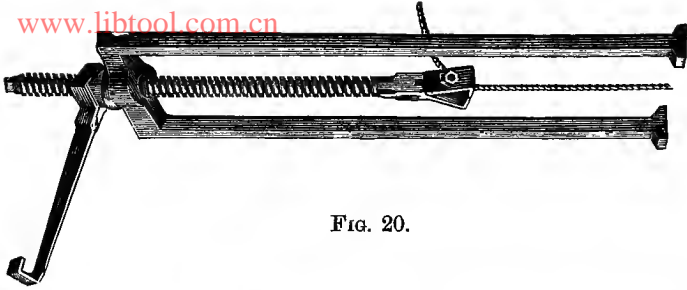

FIG. 20.

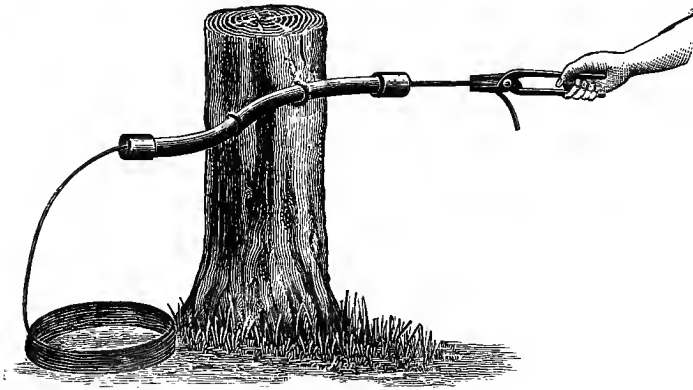

FIG. 21.

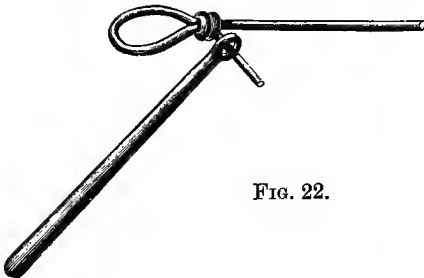

FIG. 22.

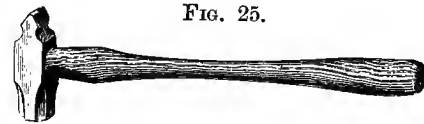

FIG. 25.



FIG. 26.



FIG. 23.



FIG. 24.

TOOLS USED IN THE ERECTION OF WIRE FENCES.

Fig. 20 represents a hand straining machine capable of tightening wires of the largest sizes; Fig. 21, a wrought-iron tube for uncoiling and straightening the wire; Fig. 22, a key for knotting or jointing wire; Figs. 23 and 24, pliers

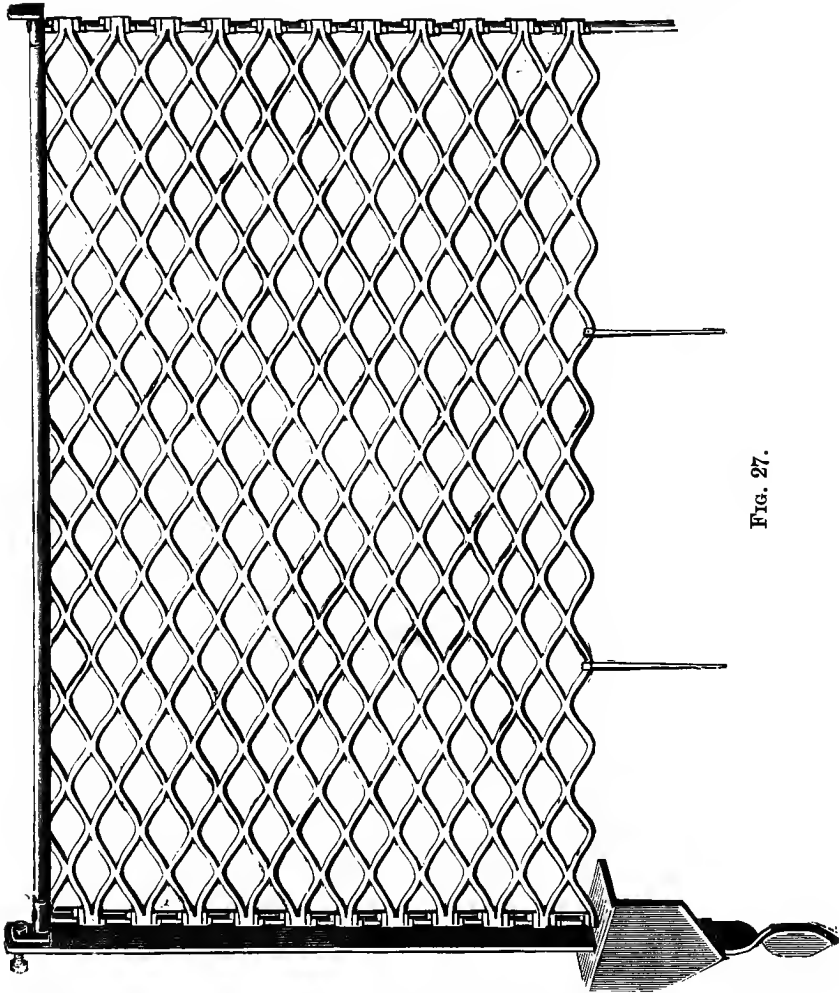

FIG. 27.

with sharp and flat points and corrugated and smooth jaws; Figs. 25 and 26, a steel-headed hammer and wrought-iron plug for holding the wires in the straining pillars. To this list of requisites a chisel and file may be added.

Fig. 27 represents a hurdle or a section of fencing composed of Golding's cut or expanded sheet metal referred to in the preceding chapter. The end opposite the standard has a rod extending below the meshed metal. Lugs form the connections for the next standard. The lugs of two sections are connected or disconnected at will by means of one bolt; the lower ends of the rods extend downward below the angular staying foot as shown at the ground line.

The standards pass through these foot-plates and are also rivetted to them, but are wholly independent of the sections.

The top rail of this fence is formed of a steel or iron tube open at its lower side and into which the upper edge of the sheet of expanded metal is secured. The lugs at each end are fastened into this tube, and the rods round which the expanded metal is lapped, are rivetted through them, thus forming a strong section, convenient for transportation, and easily and quickly erected, requiring only that the standards be driven in the ground and the sections bolted to them. Staying hooks are provided for the lower edge of the metal as shown, as also strong iron foot-pieces.

This fence will turn both large and small animals, which cannot get their heads through to feed from adjacent property, and are therefore free from the temptation to force their way.

Large quantities of simply rolled fencing wire are sold annually—more especially by German and American manufacturers—although annealed wire that has been drawn one hole or so to improve its surface and symmetry are preferred in most markets.

Space available in this volume has only permitted a mere outline of the fencing question being given.

Probably in about 1840 plain solid rolled wire was first used for fencing purposes, but it was not until shortly after the International Exhibition of 1851, that galvanised

fencing wire and strands were practically used in this country; since then the employment of wire for fencing purposes has made rapid progress until, at present, the business has assumed gigantic proportions. Some idea of the importance and enormous scope involved in the fencing question may be gathered from Professor Scott's treatise upon "Farm-fences," and wherein it is estimated that for every acre of enclosed land in this kingdom there is over £1 invested for fencing purposes.

Pursuing this basis, as applied to 45 million acres of enclosed land within this country, the author proceeds to show that a capital of nealy 50 million pounds sterling has been invested in fencing, the annual maintenance of which he states costs fully £6,750,000. These remarks of course have reference to the employment of post and rail and every other description of fencing, but when we pause to reflect upon the above named expenditure, within our comparatively small area, some idea may be formed of the field open to various kinds of wire fencing in the different agricultural and stockbreeding districts of the globe.

The first orders received by home manufacturers for fencing wire for the Australian Colonies was in about the year 1856 or 1857, and about which date bright drawn wire was in some considerable demand.

The limits of this treatise preclude descriptions of wire fences for poultry yards, dog-kennels and tennis grounds, &c., as well as many horticultural requisites, &c. Indeed, were it possible to incorporate all the mechanical productions in wire, this volume would only assume the features of a trade catalogue.

Amongst the many ornamental garden structures, however, in which wire is largely used, perhaps the rose temple, flower stand and suspension basket, illustrated in Figs. 28, 29, and 30 (as manufactured by Messrs. J. J. Thomas & Co., London), may be embodied as typical examples of their class.

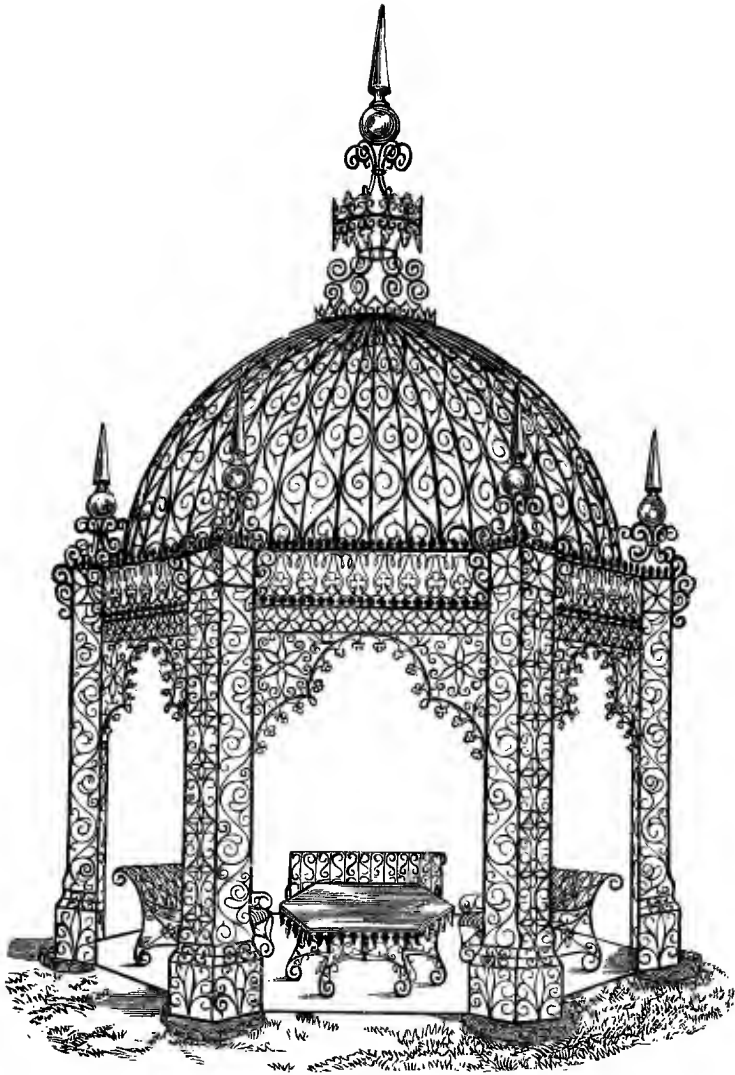

FIG. 28. HORTICULTURAL WIREWORK.

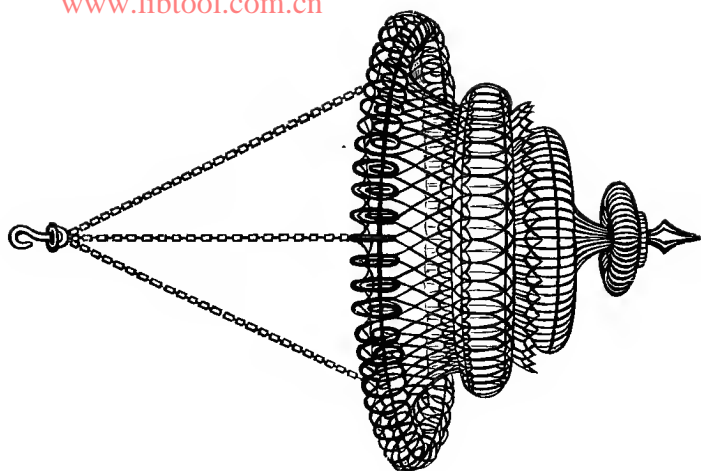

Fig. 30.

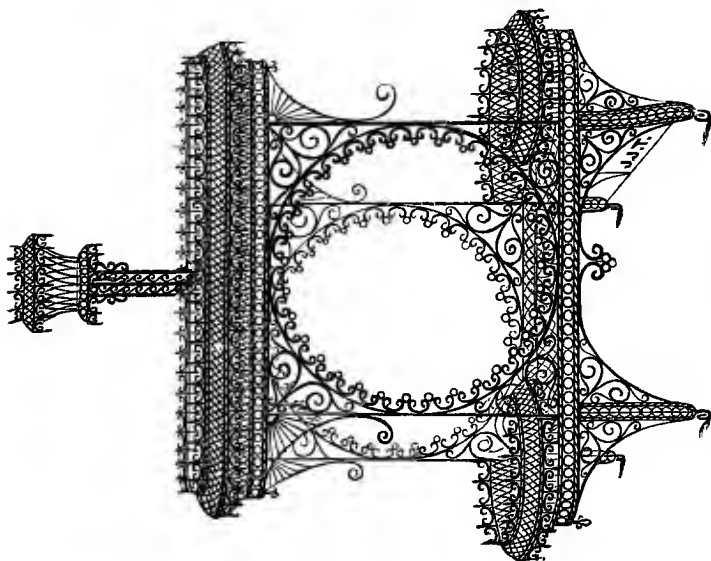

Fig. 29.

HORTICULTURAL WIREWORK.

FIG. 31.

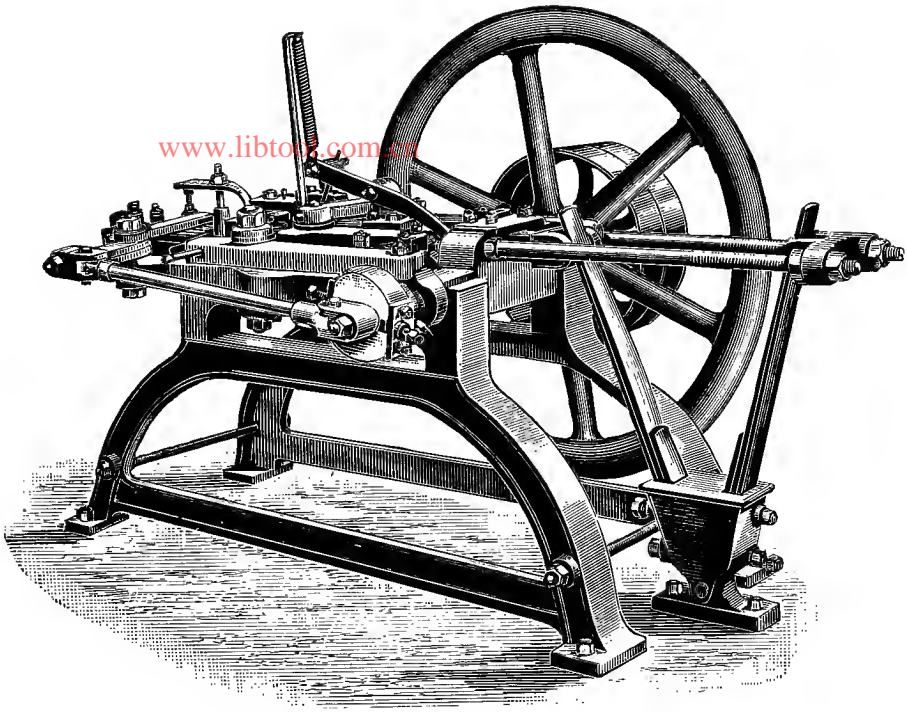
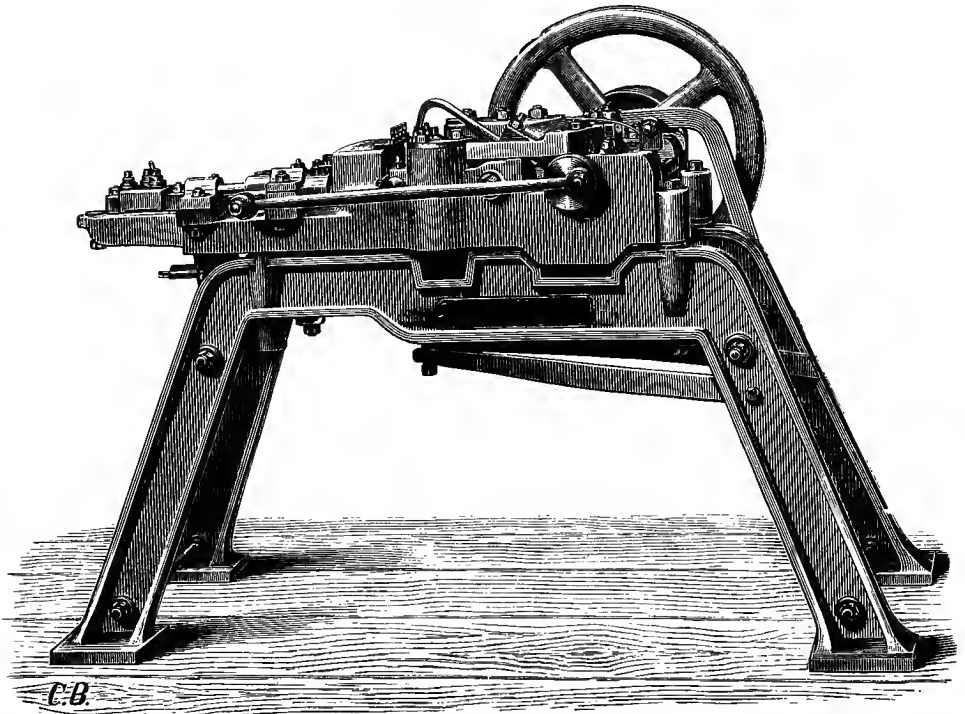

FIG. 32.



WIRE NAIL MACHINE AND PRESS.

These elegant structures may be composed of galvanised wire or be japanned in various colours. The firm above referred to obtained gold medals for their tasteful horticultural wirework at the Exhibitions held at Paris and Kensington during 1878 and 1882 respectively.

In conclusion, Figs. 31 and 32 represent typical wire-nail manufacturing machines as constructed by Messrs. T. E. Bond, of Birmingham, and Malmedie & Co., of Düsseldorf. With reference to the first design, the wire is automatically straightened from the coil and fed into the machine, where dies grip it, whilst a pair of nippers cut the wire off in suitable lengths, when it is automatically pointed and headed. The latter operation is effected by means of the spring-bolt mechanism operated by a cam on the main shaft, and which remains inoperative until a sufficient length of wire has been fed into the machine to form the next nail. The cutting and pointing is performed in one operation. The flat or blade spring, shown in the illustration, actuates the heading bolt, whilst the spiral spring attached to a lever ejects the manufactured nail. The machine is capable of producing up to 300 finished nails per minute, dependent upon the lengths and sizes required. The second figure represents a press of somewhat similar construction, with the exception of certain mechanical modifications necessary to the design, *i.e.*, the heads of the nails in this instance are formed by steady pressure instead of intermittent striking. Presses are capable of turning out more nails in a given time than machines, besides avoiding injurious concussion.

The lengths of wire nails usually range between $1\frac{1}{2}$ in. and 6 in., the space occupied by the appliances described vary from, say, 5 ft. by 2 ft. to 13 ft. by 5 ft., whilst the power required for driving the same ranges from $\frac{1}{4}$ to 2 horse-power. Readers interested in wire-working machinery of any description, can obtain every information from the manufacturers before referred to.

www.libtool.com.cn

www.libtool.com.cn

INDEX.

www.libtool.com.cn

ADVERTISEMENT.

Rylands Brothers, Limited, Warrington.

ESTABLISHED 1805.



W I R E.

All kinds – Iron and Steel, Plain, Galvanized, Tinned,
Coppered, Telegraph, and Telephone.

R O P E S.

For Mines, Collieries, Inclines, Tramways, Bridges,
Hoists, Elevators, Shipping, &c.

SIGNAL AND FENCING STRAND.

N E T T I N G.

The Largest Production of all kinds in the world.

S P R I N G S.

Every Size, Gauge, and kind.

BARBED WIRE.

INDEX.

- ABEL, Sir Frederick, on Carbon in Steel, 37
Acid and Basic Steels, 34
Adam Smith on Pins, 10
Adhesion of Driving Drums, 251
Aerial Ropeways, 253 to 266
Aerial Standing Ropes, 185
Aerial Wire Performers, 23
Aim of the Treatise (See PREFACE)
Aineworth, Captain, and Wire, 3
Albert's Invention, 153
Allen's Research on Wire and Rods, 57
Alloys of Copper, 105, 106, 109, 110, 112
Alloys of Iron, 31, 37, 109
Alloys of Silver, 112
Aluminium Wire, 110
Ambiguity of Wire Gauges, by Trotter (See PREFACE)
American Railway Rates, 272
American Rod Rolling, 43, 47
American Rope-Making Machinery, 201, 204
American Telegraphs, 7
American Wire Gauges, 130
American Wire Works, 122 to 124
Analyses of Rods and Wire Billets, 39, 40, 41, 57, 58
Analyses and Properties of Music Wire, 69
Anchoring Chains and Ropes, 278
Ancients and Wiremaking, 1
Andrew's Billets, &c., 41
Angle Fencing Strainers, 324
Annealing of Iron and Steel Wire, 56
Antiquity of Wire, 1
Applications of Different Wires, 5
Applications of Wire Ropes, 223
Apps' Great Inductorium, 7
Archal, R., and Wire, 2
Archibald Smith's Machine, 167
Attenuation of Coated Wires, 28
Augsberg and Nuremberg and Wire Drawing, 1
Australia, No Works in, 5, 222
Australian Copper, 101
Australian Fencing Wire and Orders, 331
Australians and Wire Netting, 285
Automatic Rope Clip, 246
- BABBAGE on Watch Springs, 16
Basic Steels, 34, 41
Barbed Wire Fencing, 312, 316 to 321
Barnard, Inventor of Wire Netting, 285
Barraclough's Stranding and Roping Machines, 188
Bartlett's Needle Factory, 14
Bedson's Galvanising Plant, 64
Bedson's Inventions, 4, 44
Bedson's Rod Mill, 44
Beesley & Co.'s Umbrella Wire, 15
Belgian Exports, 5, 131
Belgian Rod Train, 43
Belts of Woven Wire, 306
- Bench-Hardened Wire, 63
Berlin Music Wire Trade, 19
Beesemer & Co.'s Billets, 40
Beesemer Process for Steelmaking, 34
Biggart on Wire Ropes, 208
Billets, Acid and Basic, 40, 41
Billets, Cast-Steel, 41
Billets, Composition of, 39, 40, 41
Billets, Iron and Steel, 39
Billets, Siemens-Martin and Crucible, 40
Birmingham Wire Gauges, 127
Black or Annealed Wire, 42, 63
Black Varnished Annealed Fencing Wire, 313
Blackwall Rope Railway, 229
Bleekly's Rod Mill, 45
Blister Steel, 35
Blocks for Wiredrawing, 53, 54
Bogie Clutch Cars, 241
Bolton's Continuous Wire Mill, 102
Bond's Nail Machinery, 335
Bond's Wire Coiling Machine, 293
Bond's Wire Netting Machinery, 293
Boults' International Wire Tables (See PREFACE)
Brass and Delta Wires, 109
Brass Wire for Pinmaking, 11
Breaking Strains of Wire, To Calculate, 75, 76
Brenner's Paper on Ropes, 157
Bright Drawn or Finished Wire, 42, 63
"Britannia" Wire Joint, 142
British Wire Exports, 131
British Wire Manufacturers' Association, 128
Broadwood's Piano Wire, 21, 69
Bryne's Continuous Wire Mill, 39
Bulmer's Rope Machines, 137
Bullivant & Co.'s Works, &c., 159
Bullivant's Wire Netting, &c., 295, 304
- CABLE Tramways, 268
Cable Tramway Ropes in Australia, 220
Cable Wire Ropes, Laid, 160
Cadzow Collieries, Haulage at, 226
Calculate Strength of Wires, 75
Caleb Bell and Wire Mills, 2
Capacity of Aerial Ways, 250 to 260
Capital Invested in Fencing, 331
Carbon or Tempra of Billets, 37, 39, 40
Card Wire, 9, 67
Cars in Using Ropes, 267, 268
Carrington's Aerial Ropeways, 253
Carrington's Wire-Testing Machines, 80
Cattle Fences, 317, 324
Chain System of Haulage, 224
Charcoal Iron Wire, 32, 33
Charges of Crucible Steel, 35
Charges of Wire for Annealing, 56
Cheap Ropes Bad in End, 175
Chemical Analyses of Billets, 39, 40

- Chemical, Physical and Mechanical Considerations, 28, 29, 36, 57, 68, 69
 Chili Copper, 101
 Chromium in Iron, 37
 Classes of Various Wires, 5
 Cleveland Rod Mills, U.S.A., 51
 Clifton Collieries, Haulage at, 226
 Coiling or Bundling Fencing Wire, 313
 Coiling or Winding Ropes, Effects of, 251
 Cold-Drawing Wire, 52
 Colonial Fencing Comments, 313, 316
 Colonial and Foreign Trade, 134
 Comments on the Rope Trade, 208
 Comparative Conductivity of Iron and Copper, 136
 Comparisons *re* Mining Haulage, 237
 Competition in America, 219
 Composition of Steel Billets, 40, 41
 Composition—Wires, 115
 Compound Strands, Proportions of, 178
 Compound Stranding and Roping Machines, 198 to 203
 Conditions in Haulage, Variable, 225
 Conductivity of Aluminium and Silver, &c., 110
 Conductivity of Copper, 100, 135, 137, 143, 150
 Conductivity of Iron and Steel Affected by Impurities, 144
 Conductors, Electrical, 135 to 152
 Conductors, Stranded, Efficiency of (See PREFACE)
 Confusion of Old Gauges, 127, 129
 Continuous Rod Rolling, 44, 45, 47, 50
 Continuous Ropes in U.S.A., 272
 Continuous Wire Drawing, 80, 90, 102
 Continuous Wire Netting Machine, 296
 Contraflexure Straining of Ropes, 252
 Convention in U.S.A., Rope Trade, 218
 Copper Electrical Conductors, 99, 136, 137, 143, 150
 Copper from U.S.A., Japan, Chili, &c., 101
 Copper, its Extraction and Properties, 90
 Coppered Wire, 66
 Corney, Silver, &c., Wire Drawers, 112
 "Corrimony" Fencing, 325
 Corrugated Fencing Wire, 316
 Cost of Aerial Ropeways, 254
 Cost of Electric Traction, 271
 Cost of Endless and Tail-Rope Haulage, 225
 Cost of Fencing in Great Britain, 331
 Cost of Underground Haulage, 225
 Crane and Hoisting Ropes, 186
 Crucible Cast Steel, 35
 Cuprum, its Derivation, 90
 Curves and Side Haulage Systems, 240
 Curves Worked by Rope Haulage, 229
 Cutting Action in Wire Ropes, 211
 Cycle Spoke Wire, 19
- DAILY Services of Wire, 27
 Darlington Steel Co.'s Billets, 39
 Date, Broadwood Founded, 20
 Date, Draw-Plate Invented, 2
 Date, Felten & Guilleaume's Founded, 5
 Date, First English Wire Mill, 3
 Date, First Submarine Cable, 6, 7
 Date, Flating Mills used, 24
 Date, Gem Plates Invented, 25
 Date, Lightning Rod Conference, 25
 Date, Music Wire used, 19
 Date, Pin Machinery, 11
 Date, Railway Telegraphs, 6
 Date, Roebliog's Founded, U.S.A., 5
 Date, Rylands Founded, 3
 Date, Spectacles used, 16
 Date, Standard Wire Gauge, 29
 Date, Steel Wire Invented, 4
 Date, Steinway Founded, 20
 Date, Umbrellas Invented, 15
 Date, Wire Drawing Invented, 1, 2
 Date, Wire Fencing Introduced, 330
 Date, Wire Filigree and Lace made, 24
 Date, Wire Industry in U.S.A., 5
 Date, Wire Music Strings, 19
 Date, Wire Nail Machines, 19
 Date, Wire Netting Invented, 9
 Date, Wire used for Guns, 25
 Date, Wire Ropemaking, 8
 Date, Wire Watch Springs, 17
 "Dead Soft" Steel, 40
 Deakin's Paper on Wire Ropes, 212
 Deep Sea-Sounding Wire, 10
 Definition of Iron and Steel, 31
 Delta Metal Wire, 109
 Denison's Wire-Testing Machine, 82
 Dennis' Continuous Wire Netting Machine 296.
 Denny Brothers' Rope Hoists, 277
 Description of Pin-Making, 11
 Descriptions of Various Wires, 5
 Details of Aerial Tramways, 260 to 265
 Details in Mining Haulage, 230
 Development of U.S.A. Productions, 133
 Diamond Mines and Wire Roping, 267
 Dick's Phosphor-Bronze, 105
 Discounts in U.S.A. Rope Trade, 218
 Discovery of Platinum, 111
 Distance Ropes Carried in U.S.A., 272
 Divisibility of Metals, 28
 Dockyard Rope Appliances, 277
 Dog-Kennels and Wire, 351
 Drawing Effects on the Metal, 57, 58
 Drawing Wire Coated with Copper, 28
 Drawing Wire Cold, Discovered, 1
 Drawing Wire Continuously, 89, 90, 102
 Draw-Plates of Metal, 53, 56
 Driving Adhesion of Drums, 251
 Driving Belts of Wire, 306
 Driving Gear in Haulage Systems, 231
 "Droppers" for Fencing, 325
 Ductility of Metals, 27
 Ductility and Properties of Platinum, 111
 Durability of Electrical Conductors, 136
 Durability of Wire Ropes, 268
 Dynamo Machines and Wire, 6, 7
- EARLY Makers of Wire, 2
 Early Makers of Wire Ropes, 158
 Edwin Bray Aerial Line, 266
 Efficiency of Crane Ropes, 209
 Effects of Patenting or Improving Wire 62, 63
 Effects of Reverse Bends in Ropes, 252
 Egyptians and Wire, 1
 Elasticity of Piano Wire, 22
 Elasticity of Steel Wire, 38, 57
 Electrical Conductors, 135 to 152
 Electrical Conductors, Efficiency of Strands (See PREFACE)
 Electrical Conductivity of Copper and Silicious Bronze, 99, 107, 108, 135, 137, 139, 140, 141, 150
 Electrical Conductivity, Effects of Impurities on, 135, 136, 144
 Electrical Conductivity of Silver, 112
 Electrical Resistance of Phosphor-Bronze, 105
 Electric Lighting, 6
 Electric Propulsion of Cars, 271
 Electric Traction Wires, 8
 Electric Winding Ropes, 183
 Electro Plating, 6
 Electro Welding Machines, 145
 Electrolytically Deposited Copper, 136
 Elements found in Iron and Steel, 36, 37
 Elliptical or Oval Strands, 180

- Enclosures of Wire, 312 to 330
 Endless Rops Haulage, 224
 Engines, Rope-Hauling, 244
 Equivalents in Millimetre Gauge, 129
 Erection of the Forth Bridge, 274
 Erection of Sukkar Bridge, 274
 Erection of Wire Fences, 319, 329, 330
 Espalier Tree Fences, 327
 Expanded or Meshed Metal, 306 to 311
 Expanded Metal Fences, 330
 Experiences with Hoisting Ropes, 210
 Experiments with Wire and Ropes by Biggart, 209 to 212
 Export Trade in Germany, 131
 Extraction of Copper, 100
 Extraordinary Fine Wire, 9, 10, 89, 110, 111, 113
- FACTORS of Safety in Ropes, 213**
 Fancy Sections in Wire, 204
 Farm Fences, Cost of, 331
 Felten & Guilleaume's Works and Manufactures, 5, 117 to 121
 Fences of Expanded Metal, 330
 Fencing in Great Britain, Cost of Erection and Maintenances, 331
 Fencing Materials and Adjuncts, 312 to 330
 Fencing Materials, Makers of, 319, 321
 Fencing Strands, 322
 Fencing Wire, Elasticity, Strength and Elongation, 315
 Fencing Wire and Strands, Comparative Weights and Lengths, 322
 Fencing Wire and Strands, Introductory, 9
 Fencing Wire of Superior Steel *versus* Common Wire, 313, 314
 Filigree Silver Work, &c., 23, 112, 113
 Fine Drawn Silver, &c., Wire, 110, 112, 113
 Fine Holes in Drawplates, 113, 114
 Fine Iron, Aluminium, and Platinum, &c. Wires, 110, 111
 Fine Wire, Definition of, 55
 Fine Wires, Calculating Strengths of, 116
 Fine Wires for Optical Instruments, &c., 9, 10
 Fine Wires in Precious Metals, 23, 111, 112, 113
 Fineness of Watch Springs, 16, 17, 18
 First Submarine Cable, 7
 First Wire Mill in England, 3
 Firth & Co.'s Steel, 59
 Fisher & Walker's Driving Pulley, 229
 Fish-hooks, 14
 Fitzpatrick's Electrical Research, 136
 Flat Wire Ropes, 171
 Flattened Stranded Ropes, 180
 Flattening Wire Mills, 24
 Flexible Marine Ropes, 26, 278
 Flexibility of Mining Ropes, 251
 Flexibility of Ropes, Cause of, 161
 Flower Temples, Stands, and Baskets, 332
 Flywheels of Wire, 26
 Foreign Competition in Wire and Watch Springs, 18, 131, 132, 133, 314
 Forest of Dean, Wire, 2
 Formation of Netting Meshes, 290
 Forged Ropes, 160
 Forth Bridge Erection Ropes, 208, 274
 Foundation of Early Wire Firms, 4, 5
 Fowler's Plough Steel Wire, 58
 Fox's Card and Umbrella Wire, 15, 67
 France and Invention of Wire-drawing, 2
 Freights, Comparative, 133
 Freights in U.S.A., 272
 French Gem Draw-plates, 113
 Friction Driving Clutches, 232
 Friction, Internal and External, in Ropes, 209
- GANEVAL & Co.'s Wonderful Watch Springs, 16, 18
 Galvanised Fencing Wire, 313, 325
 Galvanised Telegraph Wire, 144 to 148
 Galvanised Wire, 63, 64, 66, 144, 313, 325
 Garden Requisites of Wire, 331 to 334
 Garrett's Wire Rod Mill, 47
 Garrucha Aerial Ropeway, 266
 Gasworks Aerial Ropeways, 253
 Gauges, Ambiguity of, by Trotter (See PREFACE)
 Gauge, Imperial Wire, 73, 123
 Gauge, Micrometer, 115
 Gauge Question, 29, 125
 Gauges, Wire, British and Foreign, &c., 125 to 130
 Gauzes of Wire, 9, 304
 Gem Draw-plates, French, 113
 Gem Draw-plates, Invention of, 25
 German Fencing Wire, 313, 314
 German Music Wire, 19, 20
 German Silver Wire, 110
 Germans and Rod Rolling, 42, 47
 Germany and Early Manufactures, 5
 Germany and Invention of Wire-drawing, 2
 Gibraltar Aerial Ropeway, 257
 Gillott's Thin Steel for Pens, 23
 Gilt Silver Wires, 113 to 115
 Glengarnock Steel, 40
 Glover's Wire Gauge and Tables, 150
 Gold on Silver Wires, Form and Process, 114
 Goldbeating, 28
 Golding's Expanded Metal, 306
 Gradation of Music Wire, 71
 Great Britain and Early Wire Industry, 2
 Greening & Sons Founded, 3
 Grip-Cars for Rope Haulage, 241
 Gripping Haulage Appliances, 234 to 245
 Grips on Aerial Ropeways, 263 to 265
 Grummetts of Woven Wire, 306
 Guaranteeing Lives of Ropes, 219
 Guards of Wire, 306
 Gubs, Wire for, 26
- HADFIELD'S Cast-Steel Pulleys, 231**
 Hadfield's Manganese Steel, 37
 Hair Springs of Watches, 16, 17, 18
 Half Pinions in Netting Machines, 289
 Hand-drawn and Machined Wire, 2
 Hard-drawn Copper Wire, Sizes, Weights, &c., 100, 102, 136, 137, 141
 Hardening and Tempering Steel Wire, 61
 Hardening Wire by Drawing, 57, 63
 Hard and Soft Copper Wires, 100, 135
 Hard Spelter Alloy, 64
 Hartz Mines and Early Wire Ropes, 154
 Haulage by Ropes in Mines, 223
 Haulage from Side of Tubs, 239
 Haulage Systems, Various, at Newcastle Exhibition, 226
 Hawasers of Wire, 278
 Heavy Coils of Roping, 272
 Hempen and Wire Marine Ropes, 279
 Herculeanum Wire Relics, 1
 Hexagonal Netting Meshes, 290
 High Breaking Strains of Steel Wire, 58, 59
 Hilda Colliery Haulage, 236
 Hill & Smith's Fencing Materials, 321
 Histories of Augsburg *re* Wire, 1
 History of Broadwood's Firm, 21
 History of Filigree Wirework, 24
 History of Music Wire, 19, 20, 21
 History of Wire Industry, 1 to 4
 Hodson's Spiral Rope Core, 185
 Hoisting Ropes used at the Forth Bridge 210
 Hong-Kong Aerial Ropeway, 254
 Horizontal Rope-Closers, 16p

- Horse-Power, Transmitted by Ropes, 283
 Horticultural Wirework, 331 to 334
 Hot Rolling of Rods, 43
 Houghton's Music and Spring Wire, 17, 69
 Hudson Rope Suspension Bridge, 282
 Human Hair not so Fine as Wire, 9, 10, 112, 113
 Hyslop on Side Haulage, 239
- IMPERIAL Wire Gauge, 73, 128
 Imported Ropes in U.S.A., 217
 Imports to U.S.A. and Australia, 133, 134
 Impractical Rope Specifications, 222
 Improving of Steel Wire, 60, 63
 Impurities in Copper, Effect of, 101, 135, 136
 Inauguration of S.W.G., 128
 Inauguration of Wire Practically, 1, 2
 Inconsistent Specifications, 208, 222
 Induction Coils, 7
 Inspector of Mines on Wire Ropes (See PREFACE)
 Interaxial Friction in Ropes, 211
 International Trade Comments, 132
 International Wire Table, Boulton's (See PREFACE)
 Introduction of Steel Music Wire, 21
 Introduction to Treatise, 1 to 29
 Introduction of Wire Fencing, 330
 Invention of Barbed Fencing Wire, 312, 316
 Invention of Cast-Steel Music Wire, 21
 Invention of Wire Netting, 284
 Invention of Wire Ropes, 153
 Invention of Gem Draw-plates, 25
 Inventor of Watch Springs, 17
 Iron Merges into Steel, 36
 Iron and Steel Annealing Wire, 56
 Iron and Steel, Distinction between, 33
 Iron and Steel Galvanised Wire, 63, 64
 Iron and Steel Music Wire, 19, 20
 Iron and Steel, Rusting of, 33
 Iron and Steel, Specific Gravity, 38
 Iron and Steel Telegraph Wire, 144
 Iron and Steel Wiredrawing, 30, 53, 54
 Iron, Swedish, 33
 Iron Wire, Charcoal and Puddled, 33
 Iron Wire, Sizes, Weights, and Strengths, 72
 Irregularity in Quality and Durability of Wire and Ropes, 213
- JAPANESE and American Ropes, 219
 Japanese Copper, 101
 Johnson & Mathey, Wiredrawers, 111
 Johnson & Nephew's Mill, 46
 Johnson & Nephew's Works, 93
 Joliet Rod Mill, U.S.A., 51
 Jointing of Barbed Wire, 319
 Jointing Telegraph, &c., Wire, 142
- "KILLING" Telegraph Wire, 146
 Kimberley, Ropes used at, 267
 King of Burmah and Umbrellas, 15
 Kitchen's Wire-Testing Machines, 84
 Knot-Grips for Aerial Lines, 265
- LABOUR Value on Watchsprings, 16, 17
 Lace and Embroideries of Wire, 113
 Laid Ropes, 160
 Laidler's Roping, 175
 Lake Superior Copper, 101
 Lancashire and Yorkshire, and Early Trade, 2, 3, 4, 5
 Lang's Laid Rope, 172
 Large Ropes, 168
 Latch & Batchelor's Locked Coil Ropes, 176
 Lateral Friction in Rolling Stock, 239
 Lattice Wirework, 306
 Latching Ropes, 273
- Leading Grip Cars, 234
 Lengths of Ropes, equal to Safe Load, 213
 Lengths of Submarine Cables, 7, 8
 Lengths of Telegraph Wire, 144
 Lengths of Wire on Dynamoes and Coils, 7
 Lengths of Wire used on Flywheels, 26, 27
 Lengths of Wire Rods, 52
 Lengths and Weights of Fencing Wire and Strands, 322
 Lenne District and Wiredrawing, 1
 Licensed Makers of Barbed Wire, 316
 Lift and Crane Ropes, 216
 Lightning Conductors, 25
 Lilleshall Co.'s Billets and Rods, 41
 Liquors, Wire Drawn Through, 30, 54
 Lives of American Traction Ropes, 273
 Lloyd's Rope Regulations, 273
 Loads Lifted in Shafts, 251
 Loads, Length, and Weight of Roping, 213
 Loads Raised by Ropes in Diamond Mining, 267
 "Locksley Hall" Raising of, 281
 London, Fine Wiredrawers, 113
 Long Ropes, Conveyance in U.S.A., 271
 Longford Mill Started, 4
 Looms, for Weaving Wire, 302
 Lord's Table of Strengths of Wire, 75
 Lowca Co. Haulage Engine, 244
 Lubricating Devices in Mines, 249
 Lubricants used for Silver Drawing, 114
 Lubricants used in Wiredrawing, 30, 54, 114
- MACHINES for Expanding Metal, 308
 Machines for Making Netting, 308
 Machines for Making Ropes, 188 to 206
 Machines for Making Wire Nails, 334
 Machines for Testing Ropes, 169
 Machines for Testing Wire, 79 to 84
 Machines for Weaving Wire, 302
 Main and Tail Rope Haulage, 224
 Maintenance of Fences, Cost, 331
 Malleability of Metals, 27, 28
 Manganese, Effects on Steel, 36
 Mannemann's Wire Flywheel, 26
 Manufacture of Card Wire, 67
 Manufacture of Copper Wire, 100 to 104
 Manufacture of Needles, 12
 Manufacture of Pins, 10, 11, 12
 Manufacture of Puddled and Charcoal Iron Wire, 32
 Manufacture of Rope Wire, 68
 Manufacture of Silver Gilt Wires, 24, 114
 Manufacture of Spangles, 24
 Manufacture of Watchsprings, 17, 18
 Manufacture of Wire in Principle, 30
 Manufacture of Wire Netting, 284
 Manufacture of Wire, Processes involved, 28, 29
 Manufacture of Wire Ropes, 153
 Manufacture of Woven Wire, 304
 Martin's Steel Process, 35
 Mathiasen's Standard of Conductivity, 135
 Matting of Woven Wire, 306
 Melbourne Tramway Ropes, 220
 Menden Schwerte's Works, 97
 Merry and Cuninghame's Billets, 40
 Meshes and Gauges of Wire Netting, 285
 Metals associated with Copper, 99
 Metals found with Platinum, 111
 Metals present with Iron, 37
 Metal-Strings for Musical Instruments, 10, 20, 21, 22, 69
 Micrometer, the, 115
 Miles of Cable Lines in U.S.A., 268
 Miles of Marine Telegraphs, 7, 8
 Miller's Music Wire, 19, 20, 69
 Millimetre Gauges, 127, 129
 Minerals carried by Aerial Lines, 250 to 260

- Mining Haulage Engines, 244
 Mining Haulage Exhibits, 223
 Mining Inspectors and Wire Ropes (See PREFACE.)
 Mining Institute's Report on Haulage, 224
 Mining Operations, Vertical, 251
 Mining Rope Haulage Systems, 226 to 250
 Mining Wagon Lubricators, 249
 Modern Wire Rod Rolling, 51
 Modern Wiredrawing Invented, 1, 2
 Molten Metal for Tempering, 61
 Monte Penna, Ropeway, 254
 Morgan's Rod Mill, U.S.A., 51
 Morris, Professor, on Tempering Wire, 63
 Multiple Laid Ropes, 216
 Music Wire, Manufacture and History, 19, 20, 21, 22
 Music Wire Tests, 69, 70

 NAILS, Wire, and Machines, 19, 334, 335
 National Wire Gauge of U.S.A., 130
 Naval Torpedo Netting, 305
 Needlemaking, Weight and Price, 12, 14
 Netting Machinery, Wire, 8, 284 to 300
 Netting, Mechanical Tight Rolling, 295
 Netting, for Protecting Vessels against Torpedoes, 305
 Newall's Inventions and Career, 156
 Newcastle Rope Haulage Exhibits, 226
 New York Suspension Bridge, 8, 60
 New York and Brooklyn Bridge Traction Ropes, 272
 Niagara Suspension Bridge, 8
 North Eastern Steel Co.'s Billets, 39
 Notes, Musical Vibrations of Wire, 22
 Number of Fish Hooks per oz., 14
 Number of Nails Made per Minute, 19
 Number of Needles per lb., 14
 Number of Pins per lb., 12
 Number of Wires in Ropes for a given Size, 215
 Nuremberg, and Origin of Wire Drawing, 2
 Nuremberg Music Wire, 19

 OBSOLETE Wire Gauges, 126
 Oil Baths for Hardening Wire, 61
 Old Wire Gauges, 126
 Order of Ductility and Tenacity, 27
 Ordnance, Wire used in, 26
 Ore of Copper, 99
 Origin of Wiredrawing, 1
 Osmond Iron Wire, 8
 Otto's Aerial Ropeways, 259
 Oval Fencing Wire, 315
 Overhead Electric Traction, 8
 Overtube, Haulage System, 240
 Oxidation of Iron and Steel, 38

 PAPER, by Biggart, on Wire Ropes, 208
 Paper, by Deakin, on Ropes, 212
 Park Fences, 322
 Patented or Improved Steel Wire, 60 to 63
 Pearson and Knowles' Rod Mill, 42, 46
 Peekskill, Suspension Bridge, 282
 Percy, Doctor, Research on Wire, 58
 Performances of Ropes in U.S.A., 273
 Performers on Suspended Wire, 23
 Phosphor Bronze, 105, 108
 Phosphorus, Effects on Steel, 37
 Physical Changes produced by Drawing, &c., 57
 Physical Properties of Metals, 27
 Piano Wire, History, Quality, &c., 19 to 21, 69
 Pinion Action in Netting Machines, 289
 Pinion Wire for Watches, 18
 Pins, History of, Making, Weight, Price, &c., 10 to 12

 Pinmaking Machinery, 11
 Pins, Quantity Made Annually, 10
 Pillars for Fencing, 325
 Plain Fencing Wire, 313
 Platinum Wire, Properties and Uses, 111
 Plough Steel, Definition of, Strength and Composition, 58
 Pöhlmann's Music Wire, 20, 21, 69
 Pole's, Doctor, Experiments with Music Wire, 21, 22, 23
 "Porcupine" Tree Guards, 321
 Portici Museum, Wire Relics, 1
 Post Office Specifications for Wire, 143 to 147
 Poultry Yards and Wire, 331
 Power Looms for Weaving Wire, 302
 Power Transmitted by Ropes, 282
 Practices in Ropemaking, 188, 192
 Preece on Silicium Bronze-Wire, 107
 Preface, See for, Stranded Conductors, Ambiguity of Gauges, and Rope Data, &c.
 Preservation by Galvanising, 63
 Press and Machine for Making Wire Nail, 334, 335
 Preventing Oxidation in Tempering, 62
 Prevention of Oxidation in Steel, 38
 Price of Wire and Ropes, 175
 Prices obtained for Ropes in U.S.A., 218
 Processes Involved in Making Wire, 28, 29, 30
 Progress in German Trade, 131
 Properties of Copper, 100
 Properties developed by Rolling and Drawing, 57
 Properties of Ductility and Tenacity, 27
 Properties of Elements in Steel, 36, 37
 Properties of Puddled Iron, &c., 32
 Properties of Steel, 37, 38
 Properties and Uses of Aluminium Wire, 110
 Properties and Uses of Silicium-Bronze, 107
 Proportions of Lays in Ropes, 174
 Puddled Iron Wire, 32
 Punches for Draw-plates, 55
 Pure Metallic Copper, 100, 101
 Purity of Silver, 113
 Purity of Swedish Iron, 33

 QUALITY of Cast Steel, 36
 Quality for Cycle Spokes, 18
 Quality for Fish-Hooks, 14
 Quality for Piano Wire, 20 to 22, 69
 Quality for Pins and Needles, 11 to 13
 Quality for Telegraph Wire, 145
 Quality for Scientific Instruments, 9, 10
 Quality for Umbrella Frames, 15
 Quality for Wire in Ropes, Irregular, 213
 Quantity of Coal Raised by Ropes, 8
 Quantity of Pins Made, 10

 RAILS Used in Mines, 230
 Railway Carriage of Ropes, 271
 Railway Rates, 133
 Railway Telegraphs History, 6
 Railway Telegraph Wire Specifications, 148, 149
 Railways, Electrical, 8, 271
 Raising Sunken Vessels, 281
 Ramsey's Clutch Bogie, 241
 Ratchet Fencing Strainers, 325
 Reels and Nippers for Hawsters, 279
 Refined Copper, 101
 Relation of Gauge of Wires to Size of Ropes, 215
 Requirements in Telegraph Wire, 143, 144
 Resistance and Sizes, Lengths, &c., of Copper Wire, 150
 Reverse Bending of Ropes, 252
 Ribbon Fencing, 316
 Right and Left-handed Strands, 175

- Right and Left Waltzing Netting Action, 289
 Rod Rolling, 42, 43 to 52
 Rods, Wire, Length of, 52, 72
 Roebing's Rod Mill and Works, 49, 122
 Rolled Fencing Wire, 330
 Rolling, Effects on Metal, 57
 Rolling Billets into Rods, 42
 Rolling or Coiling of Wire Netting, 295
 Romans and Copper, 99
 Ropes on the Brooklyn Bridge, 273
 Ropes, Considerations in Usage, 251
 Ropes, Conveyance in U.S.A., 272
 Ropes, Effects of Reverse Working or Beading, 252
 Ropes for Erecting Structures, 274
 Ropes, Flat, 171
 Ropes with Flattened Strands, 180
 Ropes and Grips, Automatic, 247
 Ropes Guaranteed a Certain Service, 219
 Ropes, Haulage, at Hodbarrow, Whitburn, Harton, Castle Eden, Moresby, Seaton-Delaval, &c., Mines, 227
 Ropes and Haulage Clips, 234 to 245
 Ropes and Haulage from Side of Tube, 239
 Ropes and Haulage in Mines, 223
 Ropes and Haulage under Tube, 227
 Ropes, Hoisting, &c., 27
 Ropes of Laidler's Design, 175
 Ropes with Lang's Lay, 173
 Ropes by Latch & Batchelor, 176
 Ropes, Machinery for Making, 168, 188 to 206
 Ropes, Manufacturers in U.S.A., 219
 Ropes for Marine Purposes, 277 to 280
 Ropes, Mining, 170 to 240
 Ropes, Number of Wires for a given Size, 215
 Ropes, Quality of Wire in, 68, 174, 183, 212, 214, 261, 267, 273
 Ropes, Railway Rates in U.S.A., 272
 Ropes for Raising Sunken Ships, 231
 Ropes and Records Kept at Mines, 213
 Ropes and Ropeways in Diamond Mining, 267
 Ropes with Scott's Sheathing, 176
 Ropes and Socket Attachments, 250
 Ropes and Testing Machinery, 169
 Ropes used in Vertical Shafts, 251
 Ropes, and Wire used for, 68, 174, 183, 214, 251, 267, 273
 Ropes, Wire, Invention and Manufacture, 8, 153
 Ropes, Wire and Strands in One Direction, 173
 Ropeways, Aerial, 253 to 266
 Rowat's Flat Roping, 171
 Royston & Sons, 4
 Rudolf's Mill, 2
 Rusting of Iron and Steel, 38, 63, 144
 Rutherford's Rope Clip, 246
 Rylands Brothers' Works, 3, 94

 SAG of Telegraph Wire, 142
 Sal-Ammoniac in Galvanizing, 64
 Salt for Drawing Wire with, 59
 Schaufhausen Teledynamic System, 233
 Scope for Wire Fencing, 331
 Scott on Cost of Fencing in Great Britain, 331
 Scott's Locked Sheathing, 176
 Seale's Rope, 184
 Section of Sheha Aerial Line, 266
 Selvage Strands in Netting, 290
 Selvage Ropes, 167
 Sentein Co.'s, Ropeway, 253
 Services of Wire Daily Experienced, 27
 Sheha Aerial Ropeway, 266
 Sheerlegs, Ropes for, 277

 Shipbuilding and Lanching Ropes, 278
 Shipment of Fencing Wire, &c., 313, 314
 Shrub or Plant-Training Fences, 327
 Shuttle Appliances in Wire-Weaving Looms, 304
 Side Haulage of Wagons, 239
 Siemens-Martin Steel, 35
 Silicious-Bronze Electrical Conductors, 108, 139, 141
 Silicon, Effects on Steel, 36
 Silver and Gilt Wires, 23, 112
 Silver Wire Ingots and Bars, 113, 114
 Silver Wire, Properties and Uses, 112
 Simultaneously Forming Strands and Roping, 198 to 203
 Size of Needles, 14
 Sizes of Drums for Ropes, 213
 Sizes, Minute, of Watchsprings, 16, 17, 18
 Sizes of Very Fine Wire, 9, 10
 Sizes of Wire in Ropes to Work Over Pulleys, 215
 Slipway Ropes, 277
 Smith & Bulmer's Rope Machinery, 187
 Smith's, Frederick, Hard-Drawn Copper Wire, 141
 Smith's, G. B., Fencing Materials, 319
 Smith's, T. & W., Rope Table, 214
 Suedhill Co., 42
 Sockets for Ropes, 250
 Soft Fencing Wire, 314
 Sources of Copper, 100, 101
 Sources of Platinum, 111
 Sources of Silver, 112
 Spangles, Manufacture of, 24, 115
 Spans of Aerial Ropeways, 250 to 280
 Special Flexible Ropes, 217
 Specific Gravity of Aluminium, 110
 Specific Gravity of Copper Dependent upon Impurities and Drawing, 100, 137
 Specific Gravity of Iron and Steel, 38
 Specific Gravity of Silver, 112
 Specifications for Electrical Wires, 143 to 146
 Specifications re Ropes, 208
 Specimens of Expanded Metal, 310
 Spectacle Frame Wire, 15
 Speed of Drawing Copper and Brass, 109
 Speed of Drawing Silver Wire, 114
 Speeds of Ropes for Transmittig Power, 283
 Speeds of Winding in Mines, 251
 Speeds of Wiredrawing, Iron and Steel, 54, 55
 Spiegeleisen, 34
 Spiral Wire Mats, 306
 Spools of Roping, Conveyance, 271
 Spottiswood's Induction Coil, 7
 Spring Netting Wire Winders, 293
 Spring Tubes in Netting Machines, 289
 Springs for Watches, 16, 17
 Standards of Electrical Conductivity, 136
 Standards for Fencing, 325
 Standards of Silver, Purity, &c., 112, 113
 Standards of Wire Gages, 73, 128
 Staples for Fencing, 314
 Steel, Acid and Basic, 34
 Steel Affected by Elements Present, 36
 Steel, Crucible, 35
 Steel, Definition of, 31
 Steel Fencing Wire, 314
 Steel, Mild and High Carbon, 33
 Steel Co. of Scotland, Billets, 39
 Steel, Soft and Hard, 33
 Steinway's Pianon, 21
 Stone's Ropemaking Machinery, 204
 Straightening, Wire Machine, 92
 Strained Wire Fences, 317 to 327
 Strainers for Fencing, 325

- Stranded Electrical Conductors (See PREFACE)
- Stranding and Roping Machines, 188 to 206
- Strands, Copper, Electrical, 146 and PREFACE
- Strands for Fences, 322
- Strands in Roping First Used, 158
- Street and other Rope Railways, 268
- Strength of Aluminium Wire, 110
- Strength of Copper and Brass Wires, 109
- Strength of Iron and Steel Wire, 42, 74
- Strength of Piano Wire, 22
- Strength of Plough Steel, 42, 58
- Strengths, Sizes, and Weights of Rope, 214, 221
- Strength of Wire, To Calculate, 76
- Stretching or Permanent Elongation of Ropes, 268, 273
- Strings for Musical Instruments, 19, 20, 21, 22
- Submarine Telegraphs, 7
- Sukkar Bridge Erection Ropes, 274
- Sulphur, Effects on Steel, 37
- Sulphur, Effects on Silver, 112
- Sunken Vessels and Wire Roping, 281
- Superior Fencing Wire, 314
- Suspension Bridge over the Hudson, 282
- Suspension Bridges, Niagara and New York, 8
- Swedish Iron, 32, 33
- Switches in Mines, 234
- TABLE of Bullivant's Ropes, 221
- Table for Calculating Strengths of Wires, 76, 116
- Table of Sizes, Weights and Strengths of Wire, 72 to 76
- Taylor, D. F., Pinmakere, 11
- Telegraph Construction and Maintenance Co., 8
- Telegraph on Railways, 6
- Telegraph, Submarine, 7
- Telegraph Wire, Iron and Steel, 144 to 148
- Telegraph Wire Joints, 142
- Telegraphs, Miles of, 7, 8
- Telphone, &c., Wires of Silicious-Bronze, 108
- Telescopes, Wire in, 9
- Telodynamic Transmission of Power, 282
- Temperature for Annealing, 56
- Temperature for Improving or Patenting, 62
- Temperature, Influence on Copper Wire, 136, 142
- Temperature, Zinc Melts, 64
- Tempering of Steel Wire, 61, 62
- Temper or Carbons of Billets, 39, 40
- Tenacity of Metals, 27
- Tennis Grounds and Wire Fences, 331
- Tensile Resistance of Music Wire, 22, 69, 71
- Tensile Resistance of Wire, To Calculate, 75, 116
- Tensile Strength Caused by Drawing, 58
- Tensile Strength of Steel Wire, 42, 58, 69, 75
- Tension on Piano Strings, 22
- Tension on Strings for Given Notes, 22
- Teeting, Wire, Machines, 79 to 84
- Tests of Forth Bridge Erection Ropes, 211
- Tests of Music Wire in Europe and U.S.A., 70
- Tests *re* American Ropes, 273
- Tests of Rope Wire, 68, 208, 273
- Theatrical Costume Wires, &c., 115
- Theodolites, Wire in, 9
- Thomas & Gilchrist Steel, 34
- Thomas' Horticultural Wirework, 332
- Thomson, Sir William, and Wire, 10
- Thornton and Continuous Wiredrawing, 89
- Three-Rail System in Mines, 238
- Tight Rolling of Wire Netting, 295
- Tinned Wire, 66
- Titan and Goliath Rope Cranes, 277
- Tools for Erecting Wire Fences, 319, 329
- Torpedo Nets, 26, 304
- Towing Hawsers, 278
- Traction, Electric, Comments on, 271
- Traction in Mines by Ropes, 224 to 245
- Traction Ropes, Good, 273
- Trade, Wire, British and Foreign, 131 to 134
- Training, Horticultural Fences, 327
- Transmission of Power by Ropes, 283
- Transportation by Aerial Ropes, 253 to 266
- Transportation of Coal by Ropes, 224
- Transportation of Wire Ropes, 271
- Treatise, Scope of, 28, 29, and PREFACE
- Treatment of Copper and Silver Ores, 101, 112
- Tredegar Iron Company's Haulage, 226
- Tree Guards of Barbed Wire, 321
- Trellis Wirework, 306
- Trenton Iron Company, U.S.A., 5, 98
- Trials of Ropes in Australia, 220
- Trotter *re* Ambiguity of Gauges (See PREFACE)
- Tubes for Wire, in Netting Machines, 289
- Twenty-four Bobbin Stradding Machines, 163
- Two-Ply Fencing Strands, 315
- Typical Constructions of Ropes, 161
- UMBRELLAS Invented, Frames, &c., 15
- Underground Rope Haulage, 225 to 243
- Under Wagons, Rope Haulage, 227
- Uniform Qualities of Wire for Ropes, 214, 267
- Uniform Wire Decorations, 113
- Unwic on Delta Metal, 109
- U.S.A. Imports, 133
- U.S.A., Rod Rolling in, 47
- Use of Lubricants in Ropes, 211
- Uses of Charcoal Iron Wire, 33
- Uses and Properties of Iron, 31
- Uses of Ropes, Comments on, 251
- Uses of Various Wire, 5
- Uses of Wire Ropes, Introductory, 8
- VALUE of Needles and Hooks per 1000, 14
- Value of Pins, 11
- Value of Watchsprings, 18
- Value of Woollen Trade, 9
- Variable Conditions in Haulage, 225
- Variations in Iron by Treatment, 31
- Various Wire Gauges, 126 to 130
- Vertical Winding Ropes, 251
- Vessels Raised by Ropes, 281
- Vibrations of Music Wire, 22
- Victorian Goldfields and Ropes, 222
- Viennese Music Wire, 19, 20
- WAR Office Aerial Ropeways, 259
- Warping Hawsers, 278
- Warrington and Early Wiremaking, 3
- Washburn & Moen's Works, 5, 123
- Watch Springs, Size, Weight, and Value, 16, 17, 18
- Watts, Fine Wire drawers, 112
- Weaving, Wire Looms, 302
- Webs, Geuzen, and Wire Fabrics, 304
- Webster Horsfall's Wire, 4, 20, 69
- Weight of Pins and Needles, 12, 14
- Weight of Rod Billets, 89
- Weight of Steel Wire, 74
- Weight of Watch Hair Springs, 16, 17, 18
- Weights and Lengths of Fencing Wire and Strands, 322
- Weights of Rope Equal to Strength, 212
- Weights, Sizes, and Strengths of Wire, 72
- Weights of Wire Netting, 286

- Weiller's List of Electrical Conductors, 137
 Weiller's Silicious Bronze, 16
 Welding of Telegraph Wire, 144
 Westfälische Union, 97
 Westgarth's Rope, 181
 Whitecross Company's Works, 96
 Wire of Acid and Basis Steels, 34, 35, 41
 Wire, Aerial, Walkers, 23
 Wire, Antiquity of, 1
 Wire, Aluminium, 110
 Wire Annealing, 54, 56, 101, 109, 114
 Wire, Arrangement in Strands, 178
 Wire, Barbed Fencing, 312, 316
 Wire, Basic Steel, 34, 41
 Wire Belting for Machinery, 306
 Wire, Bessemer Steel, 34, 39, 40
 Wire, Brass and Bronze, 102, 109
 Wire for Carding Purpose, 9, 67
 Wire, Cast Steel, 35, 36, 41
 Wire, Changes Effected by Rolling and Drawing, 57
 Wire of Charcoal and Puddled Iron, 32, 33
 Wire, Chemical and Mechanical Considerations, 30 to 42
 Wire, Class used for Netting, 285
 Wire-Coiling Machines, 293
 Wire Concerns every Community, 27
 Wire Conductors, Electrical, 135
 Wire, Continuous Drawing of, 89, 102
 Wire, Coppered and Lacquered, 66
 Wire, Copper, Hard-drawn, and Soft, 99, 100 to 102, 135 to 137, 141, 143
 Wire Cords, Lines, and Strands, 187
 Wire Cores for Mining Ropes, 185, 267
 Wire, Corrugated, 316
 Wire of Crucible steel, 35, 36
 Wire, "Dead Soft," Steel, 40, 42
 Wire Decorations for Robes and Uniforms, 113
 Wire of Delta Metal, 109
 Wire, Descriptions and Uses, 5
 Wire on Dynamo Machines, Armatures and Coils, 6, 7
 Wire drawers, how Paid, 55
 Wire drawers' Union, 55
 Wire drawing, Continuous, 89, 102
 Wire drawing Explained, 30, 53, 54
 Wire drawing Introduced into Britain, 2
 Wire drawing Invented, 1
 Wire drawing, Jumping Holes in Plate, 55
 Wire drawing Mills, 3, 4, 5, 53, 54, 93
 Wire drawing Originated in Germany, 1
 Wire, Ductility of, 27, 52, 56, 72, 89, 102, 110, 111, 112, 113, 115, 116
 Wire, Early Manufacturers of, 1 to 5
 Wire, Effects of Atmosphere on, 63, 144
 Wire, Effects of Temperature on, 136, 142, 144
 Wire, its Efficiency in Ropes, 210
 Wire, Egyptian, Early, 1
 Wire, Electrical, 135
 Wire, Elongation of, 33, 57, 59, 63, 68, 144, 210, 273
 Wire, Exhibits of, 800 B.C., 1
 Wire Fabrics, 9, 304
 Wire Factories at Home and Abroad, 93 to 98, 117 to 124
 Wire of Fancy Sections, 177, 204
 Wire Fencing, 312 to 330
 Wire Fencing, Rolled, Drawn and Galvanised, &c., 312, 330
 Wire for Fish-Hooks, 14
 Wire Flattening Mills, 24
 Wire Flexible Ropes, 26, 161, 186, 216
 Wire for Flywheels, 26
 Wire, Galvanised, 63, 64, 66
 Wire, Galvanised, To Test Efficiency of, 145
 Wire Gauge, Imperial Standard, 128
 Wire Gauge Question, 29, 73, 125 to 130
 Wire Gauzes and Cloths, &c. 9, 304
 Wire, German Silver, 110, 144
 Wire, Gilt, 24, 113
 Wire, Hardening and Tempering, 62
 Wire, High Carbon Steel, 34, 36, 41
 Wire, History of Origin and Manufacture 1 to 4
 Wire Horticultural Work, 331
 Wire in Induction Coils, 7
 Wire Industry in Lancashire and Yorkshire, 2, 3, 4
 Wire-Iron, 32
 Wire, Iron and Steel, 30 to 98
 Wire, Iron and Steel, Strengths and Weights, 72, 74
 Wire, for Laces and Decorations, 23, 113
 Wire, Lacquered, 66
 Wire, Lightning Conductors, 25, 188
 Wire, Lubricants for Drawing, 54, 114
 Wire, Jointing, 142, 145, 197
 Wire, Made 1700 B.C., 1
 Wire, Making Explained, 30
 Wire Manufacturers' Association, 128
 Wire Manufacturers in Europe and U.S.A., 93, 118
 Wire, Mild Steel, 34
 Wire Mill at Sheen, the Earliest, 3
 Wire, Marine Sounding, 10
 Wire Musical Striogs, 19, 69
 Wire Nails, Invention, &c., 19, 334
 Wire Nail Machinery, 19, 334
 Wire for Needles, 12
 Wire Netting Machines, Continuous, 296
 Wire Netting Machinery, Bond's, Dennis', and Wilmotts', 286 to 300
 Wire Netting and Woven Fabrics, 284 to 305
 Wire for New York Bridge, 60
 Wire, by the Ninevites, 1
 Wire, Oxidation of, and Effects of Wet, &c., 38, 63, 100, 144
 Wire of Phosphor-Bronze, 105
 Wire for Pins and Needles, 10, 11
 Wire, Piano or Music, 19, 20
 Wire, Poisons and Spindles, 18
 Wire, Platinum, 111
 Wire, Plough Steel, 23, 42, 58
 Wire of Puddled and Charcoal Iron, 32, 33
 Wire, Relative Electrical Conductivity of Iron and Copper, 136, 144
 Wire Relics from Hercules, 1
 Wire, for Robes, Theatrical, and Uniforms, &c., 23, 113
 Wire Rod Billets, Size, Form and Composition, 39 to 41
 Wire Rod Rolling, 42, 43, 44, 45, &c.
 Wire for Ropes, 63, 212, 214, 273
 Wire Roping, Aerial Lines, for, 185
 Wire Roping, Albert's Invention, 153
 Wire Roping, American Makers of, 219
 Wire Roping, Applications of, 223 to 283
 Wire Roping, Average Quality of Wire in, 63, 68, 174, 212, 214, 273, 284
 Wire Roping, Biggart's Paper on, 209
 Wire Roping, Commercial and Technical Considerations, and Comments *re*, 172, 174, 201, 208, 212, 213, 216, 218, 219, 220, 222, 251, 268, 272, 275
 Wire Roping, Cores in, 161, 185, 208, 212, 221, 251, 267, 273
 Wire Roping, Craze and Hoisting, 216
 Wire Roping, Effects of Reverse Bends and Coiling, &c., 210, 251, 252
 Wire Roping, Flat, 171
 Wire Roping, Flat or Oval Stranded, 180
 Wire Roping, Fowler, J., & Co., and Ploughing, 172
 Wire Roping, German Discoveries, 153

- Wire Roping, Hodaon's Spiral Core, 185
 Wire Roping, Invention of, 153
 Wire Roping, Laidler's Form, 175
 Wire Roping, Lang's Lay, 178
 Wire Roping, Latch & Batchelor's Inventions, 177 to 180
 Wire Roping, Lock-Coiled, 177
 Wire Roping, Lubricants for, 211, 212, 251, 267, 273
 Wire Roping, Machinery for Stranding and Closing, 188 to 207
 Wire Roping, Manufacture, Machinery and Practices, 159 to 170, 188 to 207
 Wire Roping for Marine Purposes, 278
 Wire Roping for Mining Purposes, 224 to 252
 Wire Roping, Multiple Laid, 216
 Wire Roping, Newall's Invention, 154
 Wire Roping, Number and Size of Wires for a given Circumference, 215
 Wire Roping, Proportion of Lays, 174, 178
 Wire Roping for Railways, 268, 273
 Wire Roping, Selvage Construction, 157
 Wire Roping, Scott's Sheathing, 176
 Wire Roping, Seal's Construction, 184
 Wire Roping, Strength of, 155, 168, 208, 213, 214, 220, 273, 274, 279
 Wire Roping, Stretching or Elongation of, 268, 273
 Wire Roping for Suspension Bridges, 8, 153, 157, 282
 Wire Roping for Tramways, Aerial, 253 to 266
 Wire Roping for Transmission of Power, 282
 Wire Roping, Uncoiling of, 251, 268, 271
 Wire Roping, Uniform Quality of Component Wires, Essential, 213, 214, 267
 Wire Roping, Westgarth's Construction, 181
 Wire Roping, Wilson's Claims, 154
 Wire, "Sag" in Telegraphic, 142
 Wire for Scientific Instruments, 9
 Wire of Siemens Steel, 40, 41
 Wire of Silicon-Bronze, 106, 108, 139
 Wire, Silver and Silver Gilt, 23, 112
 Wire, Sizes, Weights, and Strengths, 72, 74, 139, 141, 147
 Wire for Spangles, 23, 115
 Wire for Spectacle and Umbrella Frames, 15
 Wire, Speed of Drawing, 54, 55, 109, 114
 Wire, Steel, and Carbon Present, 36, 37, 39, 41
 Wire, Steel, Chemical Elements Present, 36, 37
 Wire, Steel and Iron, Rusting, 38, 63, 144
 Wire, Steel, Patented or Improved, 60 to 63
 Wire Straightening Machine, 91
 Wire, Strength, to Calculate, 75, 76, 116
 Wire, Superior Steel Fencing, 315
 Wire of Swedish Iron, 33
 Wire, Telegraphic, 6, 40, 135 to 145
 Wire, Tempering and Improving, 60 to 62
 Wire, Tempers of, *i. e.*, Carbon, 39 to 41
 Wire, Tenacity of, 27, 57, 59, 69, 72, 74, 76
 Wire, Tensile Resistances of, 57, 59, 69, 74, 76
 Wire-Testing Machines, Tensile and Torsional, 79 to 86
 Wire, Thomas Gilchrist, Steel, 34
 Wire, Tinned, 66
 Wire, To Calculate Breaking Strain of, 76, 116
 Wire Torpedo Nets, 26, 304
 Wire, Torsion of, 68, 70, 81, 141, 144, 147, 149, 209
 Wire, Trade Comments, 131 to 134
 Wire, Umbrella Frames, 15
 Wire used in Flywheels, 26
 Wire used in Netting and Woven Fabrics, 285
 Wire used in Ordnance or Guns, 26
 Wire, Various Kinds and Uses, 5
 Wire, Varnished Annealed Fencing, 313
 Wire, Very Fine, 9, 10, 89, 110, 111, 112, 113, 114
 Wire, Velocipede Spokes, 19
 Wire Watchsprings, 16, 17
 Wire-Weaving Machines, 302
 Wires, Number and Size in Ropes, To Calculate, 215
 Wollaaton's Very Fine Wire, 10
 Works and Manufactures of Bullivant & Co., 159
 Works and Manufactures of Felten & Guillaume, 117 to 121
 Works and Manufactures of Johnson & Nephew, 93
 Works and Manufactures of Menden Schwerte, 97
 Works and Manufactures of Roebling, Sons, & Co., 122
 Works and Manufactures of Rylands Bros., 95
 Works and Manufactures of Trenton Iron Company, 98
 Works and Manufactures of Washburn & Moen, 123
 Works and Manufactures of the Westphalian Union, 97
 Works and Manufactures of the Whitecross Company, 96
 Works of Wire Manufacturers at Home and Abroad, 93 to 97, 122 to 124
 Weven Wire Matting, 306
 Wright's Pinmaking Machine, 11
 ZEBRA or Corrugated Wire, 316
 Zinc Coating on Wire, Soluble, 144
 Zinc or Spelter for Galvanising and its Action, 63
 Zinc, Temperature Melts at, 64

www.libtool.com.cn

LONDON ·

PRINTED AT THE BEDFORD PRESS, 20 AND 21, BEDFORDBURY, W.C

www.libtool.com.cn

ADVERTISEMENTS.

www.libtool.com.cn

FELTEN & GUILLEAUME,

“Carlswerk,” Mülheim-on-Rhine,

NEAR COLOGNE, GERMANY,

MANUFACTURERS OF

WIRE & WIRE ROPES

THE CELEBRATED
REGISTERED



“NEPTUNE” BRAND.
IN ALL COUNTRIES.

WIRE :

Patent Crucible Plough Steel Wire.
Patent Crucible Steel Wire.
Patent Steel Card Wire.
Patent Steel Music Wire.
Copper, Bronze, and Brass Wire.
Siemens-Martin and Bessemer Wire.
Swedish and German Charcoal Wire.
Spring, Screw, Rivet, and Nail Wire,
Fencing Wire, &c.

Galvanized Telegraph Wire.
Galvanized Telephone Wire.
Galvanized Fencing Wire.
Galvanized Fencing Strand.
Galvanized Grape Wire.
Galvanized Espalier Wire.
Galvanized Cable Wire.
Galvanized Steel Wire,
all qualities.

PATENT GALVANIZED STEEL BARB WIRE.

GALVANIZED WIRE NETTING.

WIRE ROPES :

Plough Ropes.
Colliery Ropes.
Towing Ropes.
Cable Wire Tramway Ropes.
Ropes for Suspension Bridges.

Patent Steel Hawsers.
Rigging Ropes.
Ferry Ropes.
Copper Wire Ropes.
Sash Lines, &c.

TELEGRAPH, TELEPHONE, & ELECTRIC LIGHT Cables.

SOLE AGENTS FOR GREAT BRITAIN AND IRELAND :

W. F. DENNIS & CO., 11, Billiter St., London, E.C.

RICHARD JOHNSON & NEPHEW

(ESTABLISHED 1789),

BRADFORD IRON WORKS, MANCHESTER.

And **ALDERWASLEY WIRE MILLS, near DERBY.**

LONDON OFFICE: 8, Great Winchester St., E.C.

MANUFACTURERS OF

**GALVANIZED TELEGRAPH,
TELEPHONE, AND CABLE** **WIRE**

SPECIALTIES IN
CONDUCTIVITY AND HIGH-STRAIN MATERIALS.

Specially Prepared TINNED WIRE for Mattresses.

Patent Crucible Steel, Homogeneous, and
Charcoal Wires for Colliery, Tram, and
Steam Plough Ropes.

ALSO

GALVANIZED WIRE FOR HAWSERS, SHIPS' RIGGING, &c.

**USERS OF WIRE ROPES, when ordering, should specify "JOHNSON'S WIRE,"
and so ensure First-class Material being applied.**

FENCING WIRE, PLAIN AND GALVANIZED.

AND SOLE LICENSED MANUFACTURERS IN GREAT BRITAIN OF THE

GALVANIZED STEEL BARB FENCING
(PATENT.)

EVERY REEL MARKED



REGISTERED TRADE MARK.

RAMSDEN, CAMM & Co.

www.libtool.com.cn

ROBIN HOOD

and



LEOPOLD

WORKS,

Brighouse,

R & Co
B

Yorkshire.

IRON AND STEEL WIRE-DRAWERS AND GALVANIZERS.

MANUFACTURERS OF

TELEGRAPH, TELEPHONE, AND CABLE WIRE.

Contractors to H.M. Postmaster-General, the Indian and Colonial Governments, and leading Railway Companies.

MAKERS OF:-

PATENT STEEL COLLIERY ROPE WIRE, high strain.
GALVANIZED HAWSER WIRE, to LLOYD'S TESTS.
Galvanized Rigging Wire.

Galvanized Strand Fencing Wire and Staples.

Round and Sectional Drawn Rods for Screws, Nuts, &c.

Best Steel and Iron Card and Reed Wires.

FINEST SIZES of COPPER, BRASS, PHOSPHOR BRONZE, GERMAN SILVER,

TIN AND LEAD WIRES.

Telegrams: "RAMSDEN, BRIGHOUSE."



www.libtool.com.cn



FREDERICK SMITH & Co.

CALEDONIA WORKS, HALIFAX,

Contractors to the British, Indian, Colonial, and Foreign Governments
and Railway Companies.

SPECIALITY: TELEGRAPH WIRE To all Specifications.

BEST REFINED TELEPHONE WIRE.

PATENT GALVANIZED TELEGRAPH WIRE, 100 lb. Coils,
High Conductivity.

PATENT STEEL ROPE WIRE, Breaking Strain 80 to
100 tons per square in.
For Cable Tramways, Mining Ropes, Plough Ropes, &c.

GALVANIZED PATENT STEEL WIRE FOR HAWSERS.

Signal, Fencing, & Staying Strand. Speciality in Fine Steel Wire for Springs.
Hardened & Tempered Fine Steel Wire for Cardmaking.

COPPER WIRE, HIGH CONDUCTIVITY.

HARD-DRAWN HIGH-CONDUCTIVITY COPPER WIRE
for Land Lines.

COPPER WIRE, ANNEALED, PLAIN, OR TINNED; for
all Electrical Purposes.

COPPER STRAND & TAPE for Lightning Conductors.

COPPER DRAWN OR ROLLED TO ALL SECTIONS.

MAKERS OF PATENT CONTINUOUS WIRE-DRAWING MACHINES
FOR DRAWING ALL SIZES FROM NO. 14 TO NO. 40.

WEBSTER, HORSFALL & LEAN, BIRMINGHAM.

STEEL WIRE MANUFACTURERS.

ORIGINAL PATENTEES OF MUSIC AND ROPE WIRE.

Sole Manufacturers of Steel Wire in Atlantic Cables, 1865-66.

MAKERS OF BEST STEEL WIRE

FOR

PIANOS.
ROPES.
NEEDLES.

SPRINGS.
SPOKES.
HOOKS, &c.

SOUNDING,
&c., &c.

OFFICES :

1, CANNON STREET.

WORKS :

HAY MILL, COVENTRY ROAD.

PRIZE MEDALS :

LONDON—1851, 1862.

PARIS—1855, 1867.

Telegraphic Address :

“Atlantic, Birmingham,”

Prices and Samples on application.

WILLIAM SMITH & SON,

DALLAM WIRE WORKS,

WARRINGTON.

Original PATENTEES

AND

SOLE

MANUFACTURERS

— of —



SMITH'S UNRIVALLED

PATENT STEEL ROPE WIRES.
AND PLOUGH



For
Ductility and
Tensile Strength
Cannot be Surpassed.

None GENUINE but

WILLIAM SMITH & SON'S.

COLLIERY OWNERS and OTHERS when ordering STEEL WIRE ROPES should be particular in specifying for WILLIAM SMITH & SON'S WIRE. By so doing disappointment will be avoided.



www.libtool.com.cn

WIRE HOOPS & BARS.

REGISTERED BRANDS.

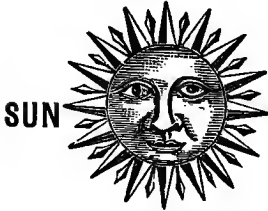

SUN

BRAND.

Rolled Wire.



Steel Wire and Hoops.



SICO



Drawn Annealed Iron Wire.

Bars and Hoops.

THE SHROPSHIRE IRON CO.

LIMITED,

Shropshire & Trench Iron and Galvanizing Works,

**HADLEY, near WELLINGTON,
SHROPSHIRE,**

MANUFACTURERS OF

Rolled Charcoal, Best Best Iron and Steel Rods for drawing purposes, Rolled Iron and Steel Fencing Rods, Small Rounds and Squares, Flat, Tip, and Small Section Iron. Hoops.

IRON & STEEL WIRE DRAWERS & GALVANIZERS.

Galvanized Telegraph, Telephone, and Cable Wire, to all Specifications, in 100-lb. pieces, without weld or joint.

RIGGING & ROPE WIRE, BUNDLE WIRE, BRIGHT ANNEALED OR GALVANIZED. TINNED BOTTLING WIRE.

IRON & STEEL FENCING WIRE, STRAND, STAPLES, &c. &c.,

For HOME, AUSTRALIA, NEW ZEALAND, and SOUTH AMERICAN MARKETS.

Contractors to H.M. GOVERNMENT, and English and Foreign Railway Companies.

SAMPLES and PRICE LISTS on application to the Works.

JOHN A. ROEBLING'S SONS

www.libtool.com.cn

COMPANY,

MANUFACTURERS OF

STEEL AND IRON WIRE ROPE,

Electric Cables and Conductors,
Iron and Copper Telegraph Wire,
Insulated Electric Wires,

BARBED WIRE FENCING.

WIRE NAILS,

WIRE CLOTH AND NETTING.

The Works of this Company are the largest in the United States, and have a capacity to complete orders of any magnitude with promptness. Its Wire Ropes made for Cable Tramways have a world-wide reputation, and are unsurpassed.

The great New York and Brooklyn Suspension Bridge, as well as many other important public works, were designed and built by the engineers of this Company.

Works at TRENTON, NEW JERSEY, U.S.A.

Offices: Nos. 117 & 119, Liberty Street, NEW YORK, U.S.A.

CORRESPONDENCE SOLICITED.

The TRENTON IRON CO.

www.history.com.cn

MANUFACTURERS OF

IRON & STEEL WIRE

OF ALL KINDS;

WIRE ROPE

For all purposes, including Cables of any desired length for Street Railways.

PATENT LOCKED WIRE ROPE.

PATENT WIRE ROPE TRAMWAYS.

PATENT QUARRY HOISTS

For Quarries, Open-cut Mines, and Contractors' Work.

Office and Works,—TRENTON, NEW JERSEY, U.S.A.

New York Office, COOPER, HEWITT & CO.,
17, BURLING SLIP, NEW YORK CITY, U.S.A.

Western Agents, FRASER & CHALMERS,
CHICAGO, ILLINOIS, U.S.A.

— ESTABLISHED 1818. —

W^M. J^{AS}. GLOVER & CO.

St. Helen's Rope Works,
ST. HELEN'S, LANCASHIRE.
 MANUFACTURERS OF

STEEL WIRE ROPES

TO THE LORDS OF THE ADMIRALTY.

PATENTEES AND MAKERS OF

HODSON'S SPIRAL WIRE CORE ROPE.



SPECIALITIES :

PATENT CRUCIBLE STEEL ROPES,

FOR WINDING, HAULING, &c.

CONSTRUCTED FROM THE

BEST PLOUGH & PATENT STEEL WIRES,

DRAWN BY WILLIAM JAMES GLOVER & Co.,

SPECIALLY PREPARED FOR EACH ROPE.

GUIDE ROPES.

GALVANIZED FLEXIBLE STEEL HAWSERS,

Guaranteed to pass Admiralty and Lloyd's requirements.

FENCING, GUY, TELEGRAPH, AND SIGNAL WIRES.

A Special Make of Round Wire Sinking Rope (non-twisting) adding greatly to the safety of the sinkers.

TELEPHONE NUMBER 39.

TELEGRAMS : "GLOVER, ST. HELENS."

Craven & Speeding Bros.,

SUNDERLAND, ENGLAND. Telegraphic Address,
"Ropes, Sunderland."

SOLE MANUFACTURERS OF

"Westgarth's Patent" Wire Ropes,

FOR COLLIERY AND SHIPPING PURPOSES.

CONTRACTORS TO THE LORDS OF THE ADMIRALTY.

WIRE ROPE DEPARTMENT.

FLAT & ROUND ROPES FOR HAULAGE & WINDING PURPOSES

MANUFACTURED FROM

PLOUGH & PATENT IMPROVED STEEL WIRE,

Specially produced from our own specification.

GALVANIZED FLEXIBLE STEEL WIRE ROPES

For Hawsers, Lifts, and Running Gear.

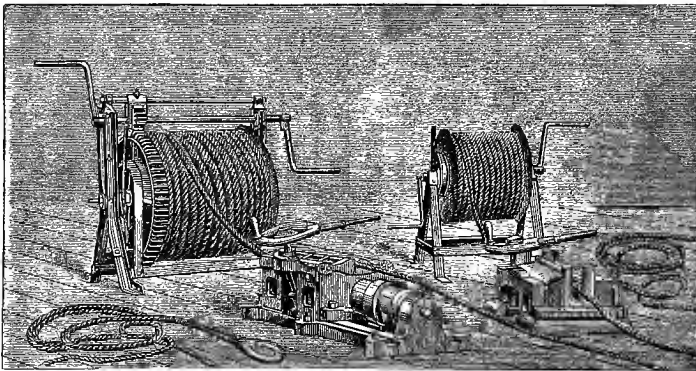

Galvanized Wire Rigging
for Marine Purposes.

GUIDE ROPES.

Aerial and Cable Tram
Ropes.

HEMP ROPE DEPARTMENT.

MANILA, SISAL, RUSSIAN HEMP, BOLTROPE, & COIR ROPES

Made by latest Improved Machinery.

MANUFACTURERS BY SPECIAL MACHINERY OF

MANILA, SISAL, & NEW ZEALAND REAPING YARN,

As used on Hornsby's, Wood's, and McCormick's Machines.

JOHN BULMER,

www.libtool.com.cn
Engineer, Millwright, and General Smith,

MANUFACTURER OF

HEMP & WIRE ROPE MACHINES

AND

Submarine Telegraph Machines,

SPRING GARDEN ENGINEERING WORKS,

Pitt Street, **NEWCASTLE-ON-TYNE.**

JOHN LORD & SON,

Springfield Wire Mill,

LEYLAND, near PRESTON, LANCASHIRE.

Telegraphic Address—

"Lord,
 Leyland."



Registered.

STEEL & IRON WIRE
 MANUFACTURERS.

IMPROVED PATENTED STEEL ROPE WIRE,

And **WIRE** from

Best Selected Swedish Iron, &c., &c.

Crown Engine and
Machine Works,

EDWARD S. BOND,

Lower Hurst St. East,
BIRMINGHAM.

PATENTEE AND SOLE MAKER OF THE

TELEGRAMS:
"RACKS," BIRMINGHAM.

"COMPACT ADJUSTABLE"

WIRE NETTING MACHINE,

Patented 1889 and 1890, in England, France, Germany, Belgium, United States of America,
and other countries.

The **SPECIAL ADVANTAGES** are Extreme Simplicity of Construction, High Speed, Great Strength of **WORKING PARTS**, and occupying considerably less **SPACE** than required by **OTHER MACHINES** of similar class. **PERFECTLY** adjustable in **EVERY PART** to regulate wear, strain, &c.

This Machine is acknowledged to be the best and most perfect Netting Machine yet invented, and is being rapidly supplied to the most important Netting Manufacturers.

Several additional **PATENTED MACHINES** and **APPLIANCES** to work in connection with the above, viz:—

AUTOMATIC BOBBIN WINDING MACHINES. **AUTOMATIC SPRING WINDING MACHINES.**
AUTOMATIC SELVEDGE MACHINES. **MECHANISM FOR MAKING CENTRE STRAND IN NETTING.**

SPECIAL MACHINES CONSTRUCTED FOR MAKING EVERY VARIETY OF WIRE NETTING
AND WOVE WIRE WORK.

EVERY POSSIBLE REQUISITE SUPPLIED FOR THE TRADE.
GALVANIZING PLANT, &c. &c.

NEW SPECIALITY—"STEELION." TRADE MARK.

This is a Metal from which the Pinions for Netting Machines are Forged, and is equal to Best Steel for Strength and Durability. These Pinions can be made to any pattern. Low Prices quoted for large or small quantities on receipt of Sample Pinion.

WIRE-WORKING MACHINERY for all Trades.

THE WARRINGTON WIRE ROPE WORKS, Limited,
13, GOREE PIAZZAS, LIVERPOOL.

CONTRACTORS TO THE ADMIRALTY AND WAR OFFICE.

ESTABLISHED NEARLY HALF-A-CENTURY.

WIRE ROPES FOR ALL PURPOSES.

Mining, Hoist, and Elevator Ropes.

TRAMWAY, BRIDGE, AND PLOUGH ROPES.

GALVANIZED FLEXIBLE STEEL WIRE ROPES,

For Trawl Warps, Hawsers, Hauling Lines, &c.

GALVANIZED WIRE ROPES FOR SHIPS' RIGGING,
&c., &c., &c.

Makers of **WIRE ROPES** with Strands and Ropes laid in the same direction, being the form in which the first Wire Ropes were made and now commonly called the Lang Lay.

TELEGRAPH ADDRESS - - "WIROP, LIVERPOOL."

The Glengarnock Iron & Steel Co.,

www.fool.com.cn

GLENGARNOCK, N.B.,

MANUFACTURERS OF

SIEMENS' & BASIC BILLETS

FOR

Ordinary & Electrical Wire.

DICK, KERR & CO., L^{td}.

Head Office, 101, LEADENHALL ST., LONDON, E.C.

Works: BRITANNIA ENGINEERING WORKS, KILMARNOCK, N.B.

SOLE PROPRIETORS OF THE LATE

PATENT CABLE TRAMWAYS CORPORATION'S PATENTS

FOR THE CONSTRUCTION OF

CABLE TRAMWAYS,

ARE PREPARED TO TENDER FOR THE

Construction and Equipment of Tramways on the Cable System.

TRACK RAILS, SLOT RAILS, ROAD PULLEYS,
ENGINES AND DRIVING GEAR,
A SPECIALITY.

HADFIELD'S

www.hbtool.com.cn

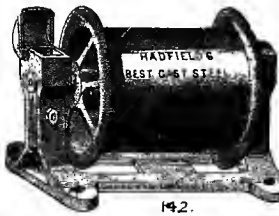

142.

STEEL FOUNDRY Co. L^d.

Hecla Works,

SHEFFIELD.

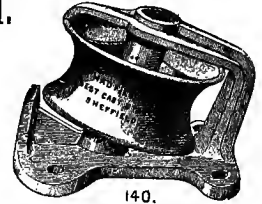

140.



133

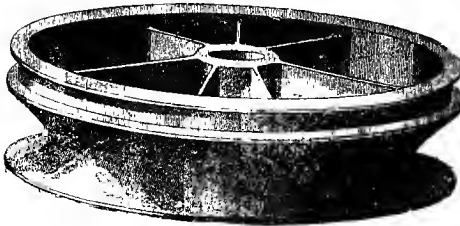

136



141

STEEL CASTINGS

OF EVERY DESCRIPTION.

PULLEYS AND ROLLERS,

Wheels, Axles, Pedestals,

&c. &c.

We have a large variety of patterns, and shall be pleased to forward tracings and particulars upon application.

TELEGRAPHIC ADDRESS, "HADFIELD, SHEFFIELD."

Telegraphic Address: "STEEL, WREXHAM."

The Brymbo Steel Co., Ltd.,
www.libtool.com.cn
WREXHAM.

PRODUCERS OF SPECIAL MILD & HARD STEELS

BY THE

Open Hearth Process.

MANUFACTURERS OF

TIN BARS.
 BILLETS.
 SLABS.

INGOTS OF ALL SIZES.
 AND SHAPES FOR
 FORGINGS.

SPECIAL STEEL FOR CASE-
 HARDENING & POLISHING
 PERFECTLY SOUND.

Bars for Engineers' and Smiths' Purposes.

ROUNDS.
 SQUARES.
 FLATS.

ANGLES.
 PLATING BARS.
 SHOEING BARS.

SPECIAL RIVET BARS.
 BICYCLE AND OTHER SPECIAL
 SECTIONS TO ORDER.

Bars for Shafting, Spindles, &c.

Bars of superior Swedish Quality of Guaranteed Carbon.

Steel of any tensile strength per sq. inch, from 22 to 40 tons.

Elongation up to 39 per cent. in 8 inches.

Carbon from .10 to 1.00 per cent.

TRADE MARK - - - - - "BRYMBO."

BIRMINGHAM OFFICE.—10, Exchange Chambers, New Street.
LIVERPOOL
MANCHESTER } **OFFICE.**—45, Arcade Chambers, St. Mary's
SHEFFIELD } Gate, Manchester.

AGENTS :
DARBY, BROWN & CO.
DARBY, BROWN & CO.

SPECIALTIES :**WIRE-DRAWING PLANT & TOOLS.****TUBE DRAWBENCHES & KINDRED MACHINERY.****METAL ROLLING MACHINERY.****SUGAR MILL MACHINERY, CANE MILLS, &c.****EVAPORATING PLANT, Single, Double, Triple, & Multiple Efféts.****ENGINES, BOILERS, PUMPS, &c. &c.****MAKERS :****SAMUEL FISHER & CO.,** Nile Foundry, **Birmingham.**

ESTABLISHED 50 YEARS.

Telegraphic Address :
"SMEROE, BIRMINGHAM."

Telephone No. 574.

WM. HORSFALL & CO.,

MANUFACTURERS OF

Best Qualities of **CAST-STEEL WIRE,**For **NEEDLES, FISH-HOOKS, SPRINGS, &c.**; also of**BEST POLISHED WIRE IN STRAIGHT LENGTHS.**ESTABLISHED
OVER 100 YEARS.**WIRE MILLS, BARNESLEY.****SPECIALTIES :** { *POLISHED STRAIGHT LENGTHS IN PINION SIZES.*
*FINE WIRE FOR HAIR SPRINGS for WATCHES, &c.***WILMOTT BROS. & COBON,****ENGINEERS AND MACHINISTS,****30, 32, & 34, ROTHERHITHE STREET,****ROTHERHITHE, S.E.****WELL-KNOWN MANUFACTURERS OF THE HIGHEST CLASS****WIRE NETTING, SPRING, BOBBIN,
AND SELVEDGE MACHINES.***ENGINES, BOILERS, AND MACHINES IN GENERAL SPECIALLY CONSTRUCTED
TO SUIT THE VARIOUS MARKETS,*

Prices and any other information forwarded on application.

TELEGRAPHIC ADDRESS: "COMBUSTION, LONDON."

OTTO'S AERIAL ROPEWAYS.

Over **450** lines at work.

SIMPLEST AND BEST MEANS OF TRANSPORT.

HIGHEST AWARD,
NEWCASTLE
EXHIBITION,
1887.

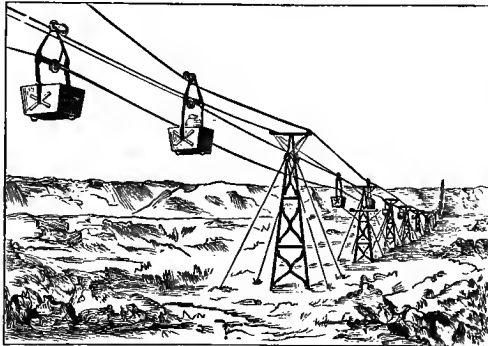

SILVER MEDAL,
CORNWALL
POLYTECHNIC,
1889.

WILL CARRY 50 TO 500 TONS PER DAY OF 10 HOURS.

CAN BE WORKED OVER GRADIENTS UP TO 1 IN 1.

ADOPTED BY

The **SHEBA**, the **EDWIN BRAY**, and many other
Mining Companies.

MINING MACHINERY

A SPECIALTY.

ESTIMATES GIVEN ON APPLICATION.

COMMANS & CO. 52, Gracechurch St.
LONDON, E.C.

CABLE TRACTION,

AS APPLIED

TO THE WORKING OF STREET AND OTHER RAILWAYS.

Copiously Illustrated, and bound in cloth, **PRICE 5s.**BY **J. BUCKNALL SMITH, C. E.,**

Author of Treatise upon Railway Traffic, Appliances, &c.

*(Late Engineer for the Construction of the Highgate Hill Cable Tramways, London, &c.)**(Late Consulting Engineer for Cable Traction to the Lisbon Tramways Company, &c.)*

CONTENTS.

INTRODUCTION.

Chapter I.—COLLIERY, MINING AND RAILWAY ROPE HAULAGE.

" II.—STREET CABLE TRAMWAYS IN CALIFORNIA, U.S.A.

" III.—THE CHICAGO, PHILADELPHIA, NEW YORK, &c., CABLE LINES.

" IV.—NEW ZEALAND CABLE TRAMWAYS.

" V.—CABLE TRACTION IN GREAT BRITAIN, EUROPE, AUSTRALIA, &c.

" VI.—COST OF CONSTRUCTING AND WORKING THE SYSTEM.

" VII.—GENERAL CONSIDERATIONS IN TRAMWAY WORKING.

" VIII.—THE MANUFACTURE OF WIRE ROPES, AND THEIR APPLICATIONS.

APPENDIX.—THE CITY OF LONDON AND GLASGOW SUBWAYS, &c., &c.

OFFICES OF "ENGINEERING,"

35 AND 36, BEDFORD STREET, STRAND, LONDON, W.C.

OPINIONS OF THE PRESS.

(The Railway Times, July 16, 1887.)

"The subject is treated with the fairness of a critic rather than the partiality of an advocate."

(The Colliery Guardian, July 22, 1887.)

"This handsome volume is devoted to a practical treatise upon the various applications of rope haulage and the manufacture of wire ropes. The book is well written in a clear and impartial manner—the general finish of the work and illustrations being excellently carried out. The author has supplied a requirement in technical literature.....full of original and valuable information."

(The English Mechanic, July 29, 1887.)

"Those who desire to know what has been done with the cable haulage system.....will find all they need in this work."

(Iron, August 20, 1887.)

"A series which comprises all that is known about cable tramways. The author has had much experience with cable traction, and his history may thus be recommended to all who wish to learn."

(The Mining Journal, September 24, 1887.)

"The author, a leading specialist on cable traction, &c.....is thoroughly at ease with all the details and ramifications of the various applications of the system, and which he clearly explains in an exhaustive and unreserved manner.....In fact, almost every conceivable application of rope haulage in all parts of the world are touched upon, so that the work should prove profitable reading to a large community, and a valuable book of reference to mining and other engineers."

(The Builder, October 22, 1887.)

"This work has a real and living interest for those engaged in working out problems of a like nature.....It is evident that tramways should have a literature, and Mr. B. Smith supplies the most important contribution yet issued."

(The Engineer, October 28, 1887.)

"In this book an interesting and useful review of the history of rope haulage in mines, on railways, and aerial ropeways—dating from 1800 to recent times—is followed by full descriptions of cable street tramways."

www.libtool.com.cn

THOS. & WM. SMITH,

Wire Rope Manufacturers,

NEWCASTLE - ON - TYNE.

“Special Flexible” and “Extra Special Flexible”

STEEL WIRE ROPES,

As most extensively used in the Erection of

THE FORTH BRIDGE,

And exclusively adopted for working the Hydraulic Gear on

H.M.S. “Victoria,” “Sans Pareil,” “Vulcan,” &c.

SMITH’S “ALBERT LAY” ROPES,

FOR MINES, STEAM PLOUGHS, CABLE TRAMWAYS, &c.

Special Ropes for Overhead Wire Tramways, Suspension Bridges, &c.

THOS. & WM. SMITH,

ST. LAWRENCE ROPEY,

NEWCASTLE-ON-TYNE.

WIRE DRAWING PLANT,

Including Blocks fitted up complete for every description and size of Wire, Annealing Pans and Ovens, Cranes, Wire Drawplates, Pritchels, Wordels, Hammers, Punches, &c.

www.libtool.com.cn

WIRE GALVANIZING PLANT (COMPLETE).

WIRE TESTING MACHINES,

Showing Tension, Elongation, and Torsion, with the utmost accuracy.

COMPLETE SETS OF MACHINES

For the Manufacture of **Iron & Steel Cables** for Railways, Tramways, Aërial Lines, Collieries, Mines, Ships' Use, Transmission of Power, Bridges, &c.:—Wire Winding Machines, **Stranding Machines** for any number of Wires.—**Cable Closing Machines** for Cables of every description, size, length, and weight, without either strand or cable-splice. **Cable Testing Machines**, Cranes, Tarring Apparatus, Bobbins, Reels, &c., &c.

PATENT COMPOUND WIRE-CABLE MAKING MACHINES.

Which Strand and Close the Cable in One Operation, and produce Cables of *every desired length and weight* without splice in either Strands or Cable.

SPECIAL MACHINES FOR SASH AND WINDOW CORDS,

Also for Lightning Conductors and Strands of all descriptions.

CORE-MAKING MACHINES

(No Ropewalk required) of the Most Improved Construction, also Jute and Hemp Winding Machines, Creels, Bobbins, Tarring Apparatus, &c.

MACHINERY FOR THE MANUFACTURE OF SUBMARINE AND
OTHER ELECTRIC CABLES,

OF EVERY SIZE AND DESCRIPTION.

Complete Sets of Machines for Covering, Taping, Insulating, Braiding, &c.,
all descriptions of Electric Wires and Strands.

CABLE TRAMWAYS AND AËRIAL LINES

Equipped with the whole of the Plant and Fittings required.

THOMAS BARRACLOUGH & CO., LIMITED, GLOBE WORKS,

Whitley Street, Rochdale Road, MANCHESTER.

London Offices: 20, BUCKLESBURY, E.C.

